

R&S® ZNL/ZNLE

Vector Network Analyzers

User Manual



1178596602
Version 13

ROHDE & SCHWARZ
Make ideas real



This manual applies to the following vector network analyzer models:

- R&S®ZNL3, 5 kHz to 3 GHz, 2 ports, N(f) connectors, order no. 1323.0012.03
- R&S®ZNL4, 5 kHz to 4.5 GHz, 2 ports, N(f) connectors, order no. 1323.0012.04
- R&S®ZNL6, 5 kHz to 6 GHz, 2 ports, N(f) connectors, order no. 1323.0012.06
- R&S®ZNL14, 5 kHz to 14 GHz, 2 ports, N(f) connectors, order no. 1323.0012.14
- R&S®ZNL20, 5 kHz to 20 GHz, 2 ports, 3.5 mm (m) connectors, order no. 1323.0012.20
- R&S®ZNLE3, 1 MHz* to 3 GHz, 2 ports, N(f) connectors, order no. 1323.0012.53
- R&S®ZNLE4, 1 MHz* to 4.5 GHz, 2 ports, N(f) connectors, order no. 1323.0012.54
- R&S®ZNLE6, 1 MHz* to 6 GHz, 2 ports, N(f) connectors, order no. 1323.0012.56
- R&S®ZNLE14, 1 MHz* to 14 GHz, 2 ports, N(f) connectors, order no. 1323.0012.64
- R&S®ZNLE18, 1 MHz* to 18 GHz, 2 ports, N(f) connectors, order no. 1323.0012.70

* 100 kHz with R&S®ZNLE-B100 low frequency extension option

© 2021 Rohde & Schwarz GmbH & Co. KG

Mühlhofstr. 15, 81671 München, Germany

Phone: +49 89 41 29 - 0

Email: info@rohde-schwarz.com

Internet: www.rohde-schwarz.com

Subject to change – data without tolerance limits is not binding.

R&S® is a registered trademark of Rohde & Schwarz GmbH & Co. KG.

Trade names are trademarks of the owners.

1178.5966.02 | Version 13 | R&S®ZNL/ZNLE

Throughout this manual, products from Rohde & Schwarz are indicated without the ® symbol, e.g. R&S®ZNL is indicated as R&S ZNL.

Contents

1	Safety and Regulatory Information.....	13
1.1	Safety Instructions.....	13
1.2	Labels on R&S ZNL/ZNLE.....	16
1.3	Korea Certification Class A.....	17
2	Documentation Overview.....	18
2.1	Getting Started Manual.....	18
2.2	User Manuals and Help.....	18
2.3	Service Manual.....	18
2.4	Instrument Security Procedures.....	19
2.5	Basic Safety Instructions.....	19
2.6	Data Sheets and Brochures.....	19
2.7	Release Notes and Open Source Acknowledgment (OSA).....	19
2.8	Application Notes, Application Cards, White Papers, etc.....	20
2.9	Calibration Certificate.....	20
3	What's New in Firmware Version 1.41.....	21
3.1	Firmware Version 1.41.....	21
3.2	Firmware Version 1.40.....	21
4	Getting Started.....	24
4.1	Preparing for Use.....	24
4.1.1	Lifting and Carrying.....	24
4.1.2	Unpacking and Checking.....	24
4.1.3	Choosing the Operating Site.....	24
4.1.4	Setting Up the R&S ZNL/ZNLE.....	25
4.1.5	Connecting to Power.....	27
4.1.6	Switching On or Off.....	30
4.1.7	Connecting to LAN.....	31
4.1.8	Connecting a Keyboard.....	32
4.1.9	Connecting an External Monitor.....	32
4.1.10	Windows Operating System.....	34
4.1.11	Logging On.....	36

4.1.12	Checking the Supplied Options.....	37
4.1.13	Considerations for Test Setup.....	38
4.2	Instrument Tour.....	39
4.2.1	Front Panel View.....	39
4.2.2	Rear Panel View.....	46
4.3	Trying Out the Instrument.....	52
4.3.1	Performing Measurements.....	52
4.3.2	Zooming into the Display.....	59
4.3.3	Saving Settings.....	60
4.3.4	Printing and Saving Results.....	62
4.3.5	Activating Additional Channel Setups.....	63
4.3.6	Trying Out Spectrum Mode.....	65
4.3.7	Performing Sequential Measurements.....	72
4.4	Operating the Instrument.....	73
4.4.1	Understanding the Display Information (VNA Mode).....	74
4.4.2	Accessing the Functionality.....	75
4.4.3	Entering Data.....	80
4.4.4	Touchscreen Gestures.....	81
4.4.5	Getting Help.....	84
5	Operating Modes, Applications, Channel Setups, and Result Displays.....	85
5.1	Available Applications.....	86
5.2	R&S MultiView.....	87
5.3	Defining Channel Setups.....	88
5.4	Running a Sequence of Measurements.....	90
5.4.1	The Sequencer Concept.....	90
5.4.2	Sequencer Settings.....	93
5.4.3	How to Set Up the Sequencer.....	93
6	Data Management.....	95
6.1	Restoring the Default Instrument Configuration (Preset).....	95
6.2	Storing and Recalling Instrument Settings and Measurement Data.....	96
6.2.1	Quick Save/Quick Recall.....	97
6.2.2	Configurable Storage and Recall.....	99

6.2.3	How to Save and Load Instrument Settings.....	104
6.3	Creating Screenshots of Current Measurement Results and Settings.....	106
6.3.1	Print and Screenshot Settings.....	106
6.3.2	How to Store or Print Screenshots of the Display.....	116
7	General Instrument Setup.....	119
7.1	Reference Frequency.....	119
7.2	Display Settings.....	120
7.2.1	Display Settings.....	120
7.2.2	How to Work with the Soft Front Panels.....	128
7.3	Language Settings.....	129
7.4	System Configuration Settings.....	129
7.4.1	Hardware Information.....	129
7.4.2	Information on Versions and Options.....	130
7.4.3	System Messages.....	132
7.4.4	Firmware Updates.....	132
7.4.5	General Configuration Settings.....	134
7.4.6	Additional Interfaces.....	135
7.5	Service Functions.....	136
7.5.1	R&S Support Information.....	136
7.5.2	Self-test Settings and Results.....	138
7.5.3	Calibration Signal Display.....	138
7.5.4	Service Functions.....	140
7.6	VNA Setup.....	141
7.6.1	Calibration Tab.....	141
7.6.2	User Interface Tab.....	143
7.6.3	Advanced Tab.....	145
7.6.4	Power Tab.....	146
7.7	Toolbar Configuration.....	147
8	Network and Remote Settings.....	149
8.1	Remote Control Interfaces and Protocols.....	149
8.1.1	LAN Interface.....	150
8.1.2	GPIB Interface (IEC 625/IEEE 418 Bus Interface).....	154
8.2	SCPI (Standard Commands for Programmable Instruments).....	156

8.3 VISA Libraries.....	156
8.4 Network and Remote Control Settings.....	156
8.4.1 General Network Settings.....	157
8.4.2 Remote Settings.....	158
8.4.3 Compatibility Settings.....	161
8.4.4 LAN Settings.....	162
8.4.5 Remote Errors.....	163
8.4.6 Returning to Manual Mode ("Local").....	165
8.5 How to Set Up a Network and Remote Control.....	166
8.5.1 How to Configure a Network.....	166
8.5.2 How to Operate the Instrument Without a Network.....	172
8.5.3 How to Log on to the Network.....	173
8.5.4 How to Share Directories (only with Microsoft Networks).....	175
8.5.5 How to Control the R&S ZNL/ZNLE via the Web Browser Interface.....	176
8.5.6 How to Deactivate the Web Browser Interface.....	177
8.5.7 How to Set Up Remote Desktop.....	178
8.5.8 How to Start a Remote Control Session from a PC.....	184
8.5.9 How to Return to Manual Operation.....	185
9 VNA Concepts and Features.....	186
9.1 Basic Concepts.....	186
9.1.1 Global (Persistent) Settings.....	186
9.1.2 Channel Setups.....	187
9.1.3 Traces, Channels and Diagrams.....	187
9.1.4 Sweep Control.....	189
9.1.5 Data Flow.....	192
9.2 VNA Screen Elements.....	196
9.2.1 Display Elements of a VNA Diagram.....	196
9.2.2 Dialogs.....	207
9.2.3 Trace Formats.....	209
9.3 Measurement Results.....	217
9.3.1 S-Parameters.....	218
9.3.2 Reference Impedances.....	219
9.3.3 Impedance Parameters.....	221

9.3.4	Admittance Parameters.....	224
9.3.5	Wave Quantities and Ratios.....	225
9.3.6	Unbalance-Balance Conversion.....	227
9.3.7	Stability Factors.....	230
9.3.8	Delay, Aperture, Electrical Length.....	230
9.4	Operations on Traces.....	231
9.4.1	Limit Check.....	231
9.4.2	Trace Files.....	238
9.4.3	Memory-Mapped Trace Data Transfer.....	247
9.5	Calibration.....	248
9.5.1	Calibration Types.....	249
9.5.2	Calibration Standards and Calibration Kits.....	253
9.5.3	Calibration Pool.....	259
9.5.4	Calibration Labels.....	260
9.5.5	Automatic Calibration.....	260
9.5.6	Parallel Calibration of Multiple Channels.....	265
9.6	Offset Parameters and De-/Embedding.....	265
9.6.1	Offset Parameters.....	265
9.6.2	Embedding and Deembedding.....	271
9.7	Optional Extensions and Accessories.....	281
9.7.1	Time Domain Analysis.....	282
9.7.2	Distance-to-Fault Measurements.....	288
9.7.3	Spectrum Analyzer Function.....	289
9.7.4	Additional Removable PC Board with SSD.....	290
9.7.5	Extended Power Range.....	290
9.7.6	Receiver Step Attenuators.....	291
9.7.7	Lower Start Frequency for R&S ZNLE.....	291
9.7.8	OCXO Frequency Reference.....	292
9.7.9	Additional Interfaces.....	292
9.7.10	GPIB Interface.....	292
9.7.11	Broadband Limiter.....	293
9.7.12	DC Power Supply 12/24 V.....	293
9.7.13	Internal Li-Ion Batteries.....	293

10	VNA GUI Reference.....	294
10.1	Function Keys and Softtools.....	294
10.2	Stimulus Softtool.....	295
10.2.1	Stimulus Tab.....	296
10.2.2	Power Tab.....	297
10.2.3	Time Domain X-Axis Tab.....	299
10.3	Scale Softtool.....	300
10.3.1	Scale Values Tab.....	301
10.3.2	Scale Coupling Tab.....	303
10.3.3	Zoom Tab.....	304
10.4	Bw Avg Power Softtool.....	306
10.4.1	Power Tab.....	306
10.4.2	Bandwidth Tab.....	307
10.4.3	Average Tab.....	308
10.5	Sweep Softtool.....	309
10.5.1	Sweep Params Tab.....	309
10.5.2	Sweep Type Tab.....	312
10.5.3	Trigger Tab.....	322
10.5.4	Sweep Control Tab.....	327
10.6	Trace Softtool.....	330
10.6.1	Traces Tab.....	330
10.6.2	Mem.....	335
10.6.3	All Mem All Data Tab.....	337
10.6.4	Math Tab.....	339
10.6.5	Time Domain Tab.....	344
10.6.6	Time Gate Tab.....	349
10.6.7	Distance to Fault Tab.....	351
10.6.8	Trace Statistics Tab.....	359
10.6.9	Smooth Shift Hold Tab.....	363
10.6.10	Infinite Averaging Tab.....	367
10.6.11	Trace Data Tab.....	367
10.7	Meas Softtool.....	375
10.7.1	S-Params Tab.....	376

10.7.2	Ratios Tab.....	383
10.7.3	Wave Tab.....	386
10.7.4	Z←Sij Tab.....	388
10.7.5	Y←Sij Tab.....	390
10.7.6	Y-Z-Params Tab.....	392
10.7.7	Stability Tab.....	394
10.8	Format Softtool.....	395
10.9	Display Lines Softtool.....	401
10.9.1	Diagram Tab.....	402
10.9.2	Split Tab.....	405
10.9.3	Config Tab.....	407
10.9.4	Limit Test Tab.....	411
10.9.5	Ripple Test Tab.....	419
10.9.6	Circle Test Tab.....	424
10.9.7	Display Circle Tab.....	427
10.9.8	Horiz. Line Tab.....	428
10.10	Marker Settings Softtool.....	429
10.10.1	Markers Tab.....	429
10.10.2	Marker Props Tab.....	432
10.10.3	Set by Marker Tab.....	434
10.10.4	Info Field Tab.....	436
10.10.5	Marker Coupling Tab.....	436
10.11	Marker Search Softtool.....	438
10.11.1	Peak Tab.....	438
10.11.2	Multiple Peak Tab.....	443
10.11.3	Target Search Tab.....	445
10.11.4	Bandfilter Tab.....	447
10.12	Cal Softtool.....	452
10.12.1	Create a User Calibration.....	452
10.12.2	Manage Calibration Devices.....	467
10.12.3	Manage User Calibrations.....	479
10.13	Channel Softtool.....	483
10.13.1	Channels Tab.....	483

10.13.2	Mode Tab.....	487
10.13.3	Channel Bits Tab.....	489
10.14	Offset Embed Softtool.....	490
10.14.1	Offset Embed Dock Widget.....	490
10.14.2	Offset Tab.....	499
10.14.3	One Way Loss Tab.....	505
10.14.4	Single Ended Tab.....	507
10.14.5	Port Sets Tab.....	510
10.14.6	Balanced Tab.....	512
10.14.7	Ground Loop Tab.....	515
10.14.8	Differential Match Tab.....	517
10.14.9	Config Tab.....	519
11	Command Reference.....	520
11.1	Conventions Used in SCPI Command Descriptions.....	520
11.2	Common Commands.....	521
11.3	Common Instrument Commands.....	525
11.3.1	Commands for Remote Instrument Operation.....	525
11.3.2	Selecting the Operating Mode and Application.....	526
11.3.3	Managing Settings and Results.....	533
11.3.4	Configuring the R&S ZNL/ZNLE.....	558
11.4	VNA Remote Control Basics.....	576
11.4.1	Block Data Format.....	576
11.4.2	Basic Remote Control Concepts.....	576
11.4.3	The IECWIN Tool.....	580
11.4.4	Status Reporting System.....	581
11.5	VNA Command Reference.....	595
11.5.1	Special Terms and Notation.....	595
11.5.2	SCPI Command Reference.....	597
11.5.3	R&S ZVR/ZVABT Compatible Commands.....	935
11.6	VNA Programming Examples.....	957
11.6.1	Basic Tasks.....	957
11.6.2	Condensed Programming Examples.....	966
11.7	List of commands.....	987

12	Troubleshooting.....	1003
12.1	Error Messages and Troubleshooting.....	1003
12.1.1	Errors during Firmware Operation.....	1003
12.1.2	Errors during Firmware Installation/Update.....	1005
12.2	System Recovery.....	1005
12.3	Collecting Information for Support.....	1006
12.4	Contacting Customer Support.....	1007
13	Transporting.....	1009
14	Maintenance, Storage, Transport and Disposal.....	1010
14.1	Cleaning.....	1010
14.2	Changing Fuses.....	1010
14.3	Handling Batteries.....	1011
14.4	Storage.....	1011
14.5	Transporting.....	1011
14.6	Disposal.....	1012
15	Annexes.....	1013
15.1	Manual Firmware Uninstallation and Installation.....	1013
15.2	System Recovery.....	1014
15.3	Interfaces and Connectors.....	1014
15.3.1	Rear Panel Connectors.....	1014
15.3.2	GPIB Interface.....	1016
15.4	Maintenance.....	1019
15.4.1	Cleaning.....	1020
15.4.2	Storing and Packing the Instrument.....	1020
	Glossary: Frequently Used Terms.....	1021
	Index.....	1027

1 Safety and Regulatory Information

The product documentation helps you use the product safely and efficiently. Follow the instructions provided here and in the [Chapter 1.1, "Safety Instructions"](#), on page 13.

Intended use

The product is intended for the development, production and verification of electronic components and devices in industrial, administrative, and laboratory environments. Use the product only for its designated purpose. Observe the operating conditions and performance limits stated in the data sheet.

Where do I find safety information?

Safety information is part of the product documentation. It warns you of potential dangers and gives instructions on how to prevent personal injury or damage caused by dangerous situations. Safety information is provided as follows:

- In [Chapter 1.1, "Safety Instructions"](#), on page 13. The same information is provided in many languages as printed "Safety Instructions". The printed "Safety Instructions" are delivered with the product.
- Throughout the documentation, safety instructions are provided when you need to take care during setup or operation.

1.1 Safety Instructions

Products from the Rohde & Schwarz group of companies are manufactured according to the highest technical standards. To use the products safely, follow the instructions provided here and in the product documentation. Keep the product documentation nearby and offer it to other users.

Use the product only for its intended use and within its performance limits. Intended use and limits are described in the product documentation such as the data sheet, manuals and the printed safety instructions. If you are unsure about the appropriate use, contact Rohde & Schwarz customer service.

Using the product requires specialists or specially trained personnel. These users also need sound knowledge of at least one of the languages in which the user interfaces and the product documentation are available.

If any part of the product is damaged or broken, stop using the product. Never open the casing of the product. Only service personnel authorized by Rohde & Schwarz are allowed to repair the product. Contact Rohde & Schwarz customer service at <http://www.customersupport.rohde-schwarz.com>.

Lifting and carrying the product

The maximum weight of the product is provided in the data sheet. To move the product safely, you can use lifting or transporting equipment such as lift trucks and forklifts. Follow the instructions provided by the equipment manufacturer.

Choosing the operating site

Only use the product indoors. The product casing is not waterproof. Water that enters can electrically connect the casing with live parts, which can lead to electric shock, serious personal injury or death if you touch the casing. If Rohde & Schwarz provides a carrying bag designed for your product, you can use the product outdoors.

Unless otherwise specified, you can operate the product up to an altitude of 2000 m above sea level. The product is suitable for pollution degree 2 environments where nonconductive contamination can occur. For more information on environmental conditions such as ambient temperature and humidity, see the data sheet.

Setting up the product

Always place the product on a stable, flat and level surface with the bottom of the product facing down. If the product is designed for different positions, secure the product so that it cannot fall over.

If the product has foldable feet, always fold the feet completely in or out to ensure stability. The feet can collapse if they are not folded out completely or if the product is moved without lifting it. The foldable feet are designed to carry the weight of the product, but not an extra load.

If stacking is possible, keep in mind that a stack of products can fall over and cause injury.

If you mount products in a rack, ensure that the rack has sufficient load capacity and stability. Observe the specifications of the rack manufacturer. Always install the products from the bottom shelf to the top shelf so that the rack stands securely. Secure the product so that it cannot fall off the rack.

Connecting to power

The product is an overvoltage category II product and has to be connected to a fixed installation used to supply energy-consuming equipment such as household appliances and similar loads. Be aware that electrically powered products have risks, such as electric shock, fire, personal injury or even death.

Take the following measures for your safety:

- Before switching on the product, ensure that the voltage and frequency indicated on the product match the available power source. If the power adapter does not adjust automatically, set the correct value and check the rating of the fuse.
- If a product has an exchangeable fuse, its type and characteristics are indicated next to the fuse holder. Before changing the fuse, switch off the instrument and disconnect it from the power source. How to change the fuse is described in the product documentation.
- Only use the power cable delivered with the product. It complies with country-specific safety requirements. Only insert the plug into an outlet with protective conductor terminal.
- Only use intact cables and route them carefully so that they cannot be damaged. Check the power cables regularly to ensure that they are undamaged. Also ensure that nobody can trip over loose cables.





- If the product needs an external power supply, use the power supply that is delivered with the product or that is recommended in the product documentation or a power supply that conforms to the country-specific regulations.
- Only connect the product to a power source with a fuse protection of maximum 20 A.
- Ensure that you can disconnect the product from the power source at any time. Pull the power plug to disconnect the product. The power plug must be easily accessible. If the product is integrated into a system that does not meet these requirements, provide an easily accessible circuit breaker at the system level.

Cleaning the product

Use a dry, lint-free cloth to clean the product. When cleaning, keep in mind that the casing is not waterproof. Do not use liquid cleaning agents.

Meaning of safety labels

Safety labels on the product warn against potential hazards.

	<p>Potential hazard</p> <p>Read the product documentation to avoid personal injury or product damage.</p>
	<p>Electrical hazard</p> <p>Indicates live parts. Risk of electric shock, fire, personal injury or even death.</p>
	<p>Hot surface</p> <p>Do not touch. Risk of skin burns. Risk of fire.</p>
	<p>Protective conductor terminal</p> <p>Connect this terminal to a grounded external conductor or to protective ground. This protects you against electric shock should an electric problem occur.</p>

Handling batteries safely

The product contains lithium polymer or lithium ion cells or batteries. The use of the word battery in the following always means all types. Only the battery contents are potentially hazardous. As long as a battery is undamaged and the seals remain intact, there is no danger.

Impact, shock or heat can cause damage such as dents, punctures and other deformations. A damaged battery poses a risk of personal injury. Handle a damaged or leaking battery with extreme care. Immediately ventilate the area since the battery releases harmful gases. If you come into contact with the battery fluid, immediately remove all contaminated clothing. Irritation can occur if the battery fluid comes in contact with your skin or eyes. Immediately and thoroughly rinse your skin or eyes with water and seek medical aid.

For safe handling, follow these rules:

- Do not short-circuit the battery.
- Do not mechanically damage the battery. Do not open or disassemble the battery.

- Do not expose the battery to high temperatures such as open flames, hot surfaces and sunlight.
- Only use the battery with the designated Rohde & Schwarz product.
- Only use the appropriate Rohde & Schwarz charger to charge the batteries. If the batteries are improperly charged, there is a risk of explosion. For charging and discharging temperature ranges, see the product documentation.
- Store the battery at room temperature (approximately 20 °C) enclosed in the original packaging.
- Dispose of batteries separately from normal household waste as specified by the local waste disposal agency.

If you disregard these rules, you risk serious personal injury or even death due to explosion, fire or hazardous chemical substances. The product documentation provides further details.

When replacing a defective battery, only use the same Rohde & Schwarz battery type. When returning batteries to Rohde & Schwarz subsidiaries, choose a carrier qualified to transport dangerous goods and follow the carrier's transport stipulations in line with IATA-DGR, IMDG-Code, ADR or RID. If you need assistance, contact the carrier or Rohde & Schwarz customer service.

Connecting headphones



Take the following measures to prevent hearing damage. Before using headphones, check the volume and reduce it if necessary. If you monitor varying signal levels, take off the headphones and wait until the signal has settled. Then adjust the volume.

1.2 Labels on R&S ZNL/ZNLE

Labels on the casing inform about:

- Personal safety, see "[Meaning of safety labels](#)" on page 15
- Product and environment safety, see [Table 1-1](#)
- Identification of the product, see [Chapter 4.2.2.14, "Device ID"](#), on page 52

Table 1-1: Labels regarding R&S ZNL/ZNLE and environment safety

	<p>Labeling in line with EN 50419 for disposal of electrical and electronic equipment after the product has come to the end of its service life. For more information, see the product user manual, chapter "Disposal".</p>
	<p>Labeling in line with directive 2006/66/EC for disposal of batteries after they have come to the end of their service life. For more information, see the R&S ZNL/ZNLE user manual, chapter "Disposal".</p>

1.3 Korea Certification Class A



이 기기는 업무용(A급) 전자파 적합기기로서 판매자 또는 사용자는 이 점을 주의하시기
바라며, 가정외의 지역에서 사용하는 것을 목적으로 합니다.

2 Documentation Overview

This section provides an overview of the R&S ZNL/ZNLE user documentation. Unless specified otherwise, you find the documents on the R&S ZNL/ZNLE product page at:

www.rohde-schwarz.com/manual/ZNL or www.rohde-schwarz.com/manual/ZNLE.

2.1 Getting Started Manual

Introduces the R&S ZNL/ZNLE and describes how to set up and start working with the product. Includes basic operations, typical measurement examples, and general information, e.g. safety instructions, etc.

A printed version is delivered with the instrument. A PDF version is available for download on the Internet.

2.2 User Manuals and Help

Separate user manuals are provided for the base unit and the firmware applications:

- Base unit manual
Contains the description of all instrument modes and functions. It also provides an introduction to remote control, a complete description of the remote control commands with programming examples, and information on maintenance, instrument interfaces and error messages. Includes the contents of the getting started manual.
- Firmware application manual
Contains the description of the specific functions of a firmware application, including remote control commands. Basic information on operating the R&S ZNL/ZNLE is not included.

The contents of the user manuals are available as help in the R&S ZNL/ZNLE. The help offers quick, context-sensitive access to the complete information for the base unit and the firmware applications.

All user manuals are also available for download or for immediate display on the Internet.

2.3 Service Manual

Describes the performance test for checking the rated specifications, module replacement and repair, firmware update, troubleshooting and fault elimination, and contains mechanical drawings and spare part lists.

The service manual is available for registered users on the global Rohde & Schwarz information system (GLORIS):

<https://gloris.rohde-schwarz.com/irj/portal/SearchDetailView?downloadContainerID=484937>

[ZNL service manual](#), [ZNLE service manual](#)

2.4 Instrument Security Procedures

Deals with security issues when working with the R&S ZNL/ZNLE in secure areas. It is available for download on the Internet.

2.5 Basic Safety Instructions

Contains safety instructions, operating conditions and further important information. The printed document is delivered with the instrument.

2.6 Data Sheets and Brochures

The data sheet contains the technical specifications of the R&S ZNL/ZNLE. It also lists the firmware applications and their order numbers, and optional accessories.

The brochure provides an overview of the instrument and deals with the specific characteristics.

See www.rohde-schwarz.com/brochure-datasheet/ZNL or www.rohde-schwarz.com/brochure-datasheet/ZNLE.

2.7 Release Notes and Open Source Acknowledgment (OSA)

The release notes list new features, improvements and known issues of the current firmware version, and describe the firmware installation.

The open-source acknowledgment document provides verbatim license texts of the used open source software.

See www.rohde-schwarz.com/firmware/ZNL or www.rohde-schwarz.com/firmware/ZNLE.

2.8 Application Notes, Application Cards, White Papers, etc.

These documents deal with special applications or background information on particular topics.

See www.rohde-schwarz.com/application/ZNL or www.rohde-schwarz.com/application/ZNLE.

2.9 Calibration Certificate

The document is available on <https://gloris.rohde-schwarz.com/calcert>. You need the device ID of your instrument, which you can find on a label on the rear panel.

3 What's New in Firmware Version 1.41

This section lists the changes introduced in the current version of the R&S ZNL/ZNLE firmware.

Software version

- ▶ To check your R&S ZNL/ZNLE "Instrument Firmware" and "VNA Server" version, select [SETUP] > "System Config" > "Versions + Options".



Downgrade to a firmware version < 1.22

To downgrade the firmware from a version $X \geq 1.22$ to a version $Y < 1.22$, it is required to uninstall firmware version X manually (using Windows "Apps & Features"). Then, after a possible reboot of the instrument, install firmware version Y.

For details on manual firmware deinstallation and installation see the annex of the R&S ZNL/ZNLE User Manual or Help System.

3.1 Firmware Version 1.41

This section lists the changes introduced in firmware version 1.41.

Solved issues

- Software option R&S®ZNL-K14 did not appear in [Setup] > "System Configuration" > "Versions + Options"

Spectrum analysis changes (R&S ZNL only)

The spectrum analysis function of the R&S ZNL (with hardware option B1) and its additional software options are based on firmware 1.70 of the Rohde & Schwarz spectrum analyzer R&S FPL1000.

See the Release Notes of the R&S FPL1000 (at <https://www.rohde-schwarz.com/firmware/fpl1000/>) for a history of changes.

3.2 Firmware Version 1.40

This section lists the changes introduced in firmware version 1.40.

New functionality

- Support for new instrument models:
 - R&S®ZNL14, 5 kHz to 14 GHz, 2 ports, N(f) connectors, order no. 1323.0012.14
 - R&S®ZNL20, 5 kHz to 20 GHz, 2 ports, 3.5 mm (m) connectors, order no. 1323.0012.20

- R&S®ZNLE14, 1 MHz* to 14 GHz, 2 ports, N(f) connectors, order no. 1323.0012.64
- R&S®ZNLE18, 1 MHz* to 18 GHz, 2 ports, N(f) connectors, order no. 1323.0012.70

* 100 kHz with R&S®ZNLE-B100 low frequency extension option

Note that for these R&S®ZNL14 and R&S®ZNL20 models, the Spectrum Analysis option and all other dependent options **are not available** and **will not be available** in future.

Successor models, which will support the B1 option and all other dependent options will be available at a later stage.

- Software option R&S®ZNL-K14 "Independent CW source for R&S®ZNL" enables continuous wave stimuli in Spectrum Mode, using port 1 as the driving port. Requires option R&S®ZNLx-B1.
- "Web Control": browser-based access to the R&S ZNL/ZNLE GUI via the instrument's web interface
See [Chapter 8.1.1.4, "LAN Web Browser Interface"](#), on page 152

New remote control functionality

- ENA emulation command alias [`SENSe<Ch>`] : `SWEep:MODE`

Improvements

- The number of decimal places can now also be configured for *meter* values
See ["Decimal Places"](#) on page 144
- Trace data export: the number of decimal places of stimulus and response values can now be configured
See ["Decimal Places"](#) on page 372
- Support for Spectrum Analysis framework FS-SNS18 added
- Lower minimum "Ref Value" in polar diagrams allows larger scaling

Solved issues

- Changing the average factor was ignored while averaging was active
- Limit line check: PASS/FAIL info field disappeared when diagram was maximized
- Command `SENSe<Ch>:SWEep:TYPE POINT` did not always switch from segmented to CW sweep mode
- LAN power sensors R&S NRP18SN and R&S NRP18AN were not detected correctly
- Formula-defined limit lines were not exported to limit line files (`*.limit`)
- "Repeat Cal" remained enabled after incompatible changes of the swept frequencies
- Markers on traces whose value at the marker position was above or below the visible range, were not displayed
- Option installation via GUI: empty alert message if unsuccessful
- Automatic calibration: changing the port assignment to non-default or after auto-detection did not work and caused an exception

Spectrum analysis changes (R&S ZNL only)

The spectrum analysis function of the R&S ZNL (with hardware option B1) and its additional software options are based on firmware 1.70 of the Rohde & Schwarz spectrum analyzer R&S FPL1000.

See the Release Notes of the R&S FPL1000 (at <https://www.rohde-schwarz.com/firmware/fpl1000/>) for a history of changes.

4 Getting Started

4.1 Preparing for Use

Here, you can find basic information about setting up the instrument for the first time.

• Lifting and Carrying	24
• Unpacking and Checking	24
• Choosing the Operating Site	24
• Setting Up the R&S ZNL/ZNLE	25
• Connecting to Power	27
• Switching On or Off	30
• Connecting to LAN	31
• Connecting a Keyboard	32
• Connecting an External Monitor	32
• Windows Operating System	34
• Logging On	36
• Checking the Supplied Options	37
• Considerations for Test Setup	38

4.1.1 Lifting and Carrying

The carrying handles are designed to lift or carry the instrument. Do not apply excessive external force to the handles.

See "[Lifting and carrying the product](#)" on page 13.

4.1.2 Unpacking and Checking

1. Unpack the R&S ZNL/ZNLE carefully.
2. Retain the original packing material. Use it when transporting or shipping the R&S ZNL/ZNLE later.
3. Using the delivery notes, check the equipment for completeness.
4. Check the equipment for damage.

If the delivery is incomplete or equipment is damaged, contact Rohde & Schwarz.

4.1.3 Choosing the Operating Site

Specific operating conditions ensure proper operation and avoid damage to the product and connected devices. For information on environmental conditions such as ambient temperature and humidity, see the data sheet.

See also "[Choosing the operating site](#)" on page 14.

Electromagnetic compatibility classes

The electromagnetic compatibility (EMC) class indicates where you can operate the product. The EMC class of the product is given in the data sheet under "General data".

- Class B equipment is suitable for use in:
 - Residential environments
 - Environments that are directly connected to a low-voltage supply network that supplies residential buildings
- Class A equipment is intended for use in industrial environments. It can cause radio disturbances in residential environments due to possible conducted and radiated disturbances. It is therefore not suitable for class B environments. If class A equipment causes radio disturbances, take appropriate measures to eliminate them.

4.1.4 Setting Up the R&S ZNL/ZNLE

The R&S ZNL/ZNLE is designed for use either on a bench top or in a rack, or as a portable instrument (with optional battery operation) in a transport bag in the field.

See also:

- "[Setting up the product](#)" on page 14
- "[Intended use](#)" on page 13

4.1.4.1 Placing the R&S ZNL/ZNLE on a Bench Top

To place the product on a bench top

1. Place the product on a stable, flat and level surface. Ensure that the surface can support the weight of the product. For information on the weight, see the data sheet.
2. **CAUTION!** Foldable feet can collapse. See "[Setting up the product](#)" on page 14. Always fold the feet completely in or out. With folded-out feet, do not place anything on top or underneath.
3. **CAUTION!** The product can fall over and cause injury. The top surface is too small for stacking. Never stack another product on top of the product.

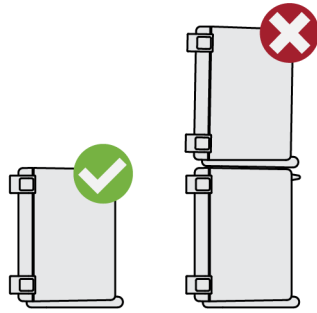

As an alternative, you can mount several products in a rack.

4. **NOTICE!** Overheating can damage the product.

Prevent overheating as follows:

- Keep a minimum distance of 10 cm between the fan openings of the product and any object in the vicinity.
- Do not place the product next to heat-generating equipment such as radiators or other products.

4.1.4.2 Mounting the R&S ZNL/ZNLE in a Rack

To prepare the rack

1. Observe the requirements and instructions in "[Setting up the product](#)" on page 14.
2. **NOTICE!** Insufficient airflow can cause overheating and damage the product. Design and implement an efficient ventilation concept for the rack.

To mount the R&S ZNL/ZNLE in a rack

1. Use an adapter kit to prepare the R&S ZNL/ZNLE for rack mounting.
 - a) Order the rack adapter kit designed for the R&S ZNL/ZNLE. For the order number, see the data sheet.
 - b) Mount the adapter kit. Follow the assembly instructions provided with the adapter kit.
2. Lift the R&S ZNL/ZNLE to shelf height.
3. Grab the handles and push the R&S ZNL/ZNLE onto the shelf until the rack brackets fit closely to the rack.
4. Tighten all screws in the rack brackets with a tightening torque of 1.2 Nm to secure the R&S ZNL/ZNLE in the rack.

To unmount the R&S ZNL/ZNLE from a rack

1. Loosen the screws at the rack brackets.
2. Remove the R&S ZNL/ZNLE from the rack.

3. If placing the R&S ZNL/ZNLE on a bench top again, unmount the adapter kit from the R&S ZNL/ZNLE. Follow the instructions provided with the adapter kit.

4.1.4.3 Portable Operation

An optional carrying bag designed specifically for the R&S ZNL allows you to protect the instrument while working in the field. The bag includes ventilation areas at the position of the ventilation outlets in the casing to ensure air circulation. The transparent cover allows you to operate the instrument without removing it from the bag. With the help of the optional vest holster, you can carry the R&S ZNL in its bag and keep your hands free. Together with the optional battery pack (see [Chapter 4.1.5.3, "Optional Battery Pack \(R&S FPL1-B31\)"](#), on page 29), and packed in the dedicated carrying bag, the R&S ZNL is ideally suited for operation directly in the field, even in rough environments.



- ▶ Inspect the carrying bag for wear and tear before placing the instrument in it.

For details on optional accessories, see the R&S ZNL data sheet.

4.1.5 Connecting to Power

There are various options to supply power to the R&S ZNL/ZNLE.

- The R&S ZNL/ZNLE is equipped with an AC power supply connector.
- The R&S ZNL can also be equipped with an optional (internal) DC power supply connector (R&S FPL1-B30).

- The R&S ZNL allows for battery operation if option R&S FPL1-B31 is installed.

4.1.5.1 Connecting the AC Power

The R&S ZNL/ZNLE can be used with different AC power voltages and adapts itself automatically to it. Refer to the datasheet for the requirements of voltage and frequency.

For safety information, see ["Connecting to power"](#) on page 14.

To connect the AC power



1. Plug the AC power cable into the AC power connector on the rear panel of the instrument. Only use the AC power cable delivered with the R&S ZNL/ZNLE.
2. Plug the AC power cable into a power outlet with ground contact.
The required ratings are listed next to the AC power connector and in the data sheet.

For details on the connector, refer to [Chapter 4.2.2.1, "AC Power Supply Connection and Main Power Switch"](#), on page 47.

4.1.5.2 Connecting an Optional DC Power Supply (R&S FPL1-B30)

The R&S ZNL can also be equipped with an optional DC power supply connector (R&S FPL1-B30). If installed, the R&S ZNL can be operated by a DC voltage of +12 V to +24 V. For details on the connector see [Chapter 4.2.2.2, "Li-Ion Battery Packs and DC Power Connector"](#), on page 47.



This option is not available for the R&S ZNLE.

If you use an external power supply unit to supply safety extra-low DC voltage (SELV) to the instrument, be sure to meet the requirements for reinforced/double insulation in accordance with DIN/EN/IEC 61010 (UL 3111, CSA C22.2 No. 1010.1) or DIN/EN/IEC 60950 (UL 1950, CSA C22.2 No. 950). Provide current limitation in accordance with DIN EN 61010-1 Appendix F2.1. Use a cable no longer than 3 m.

Also see ["Connecting to power"](#) on page 14.



DC connection

- ▶ Connect the DC power connector on the rear panel of the R&S ZNL to the DC power source using a cable as described above.

4.1.5.3 Optional Battery Pack (R&S FPL1-B31)

As an alternative to the fixed AC or DC power supply, the R&S ZNL also allows for battery operation. The "Battery Pack" option R&S FPL1-B31 comprises two Li-ion batteries and an internal charger. The internal charger charges the batteries whenever the instrument is connected to AC or DC power. During operation, if neither DC nor AC power is supplied, the R&S ZNL automatically switches to battery operation.

The battery pack can be retrofitted by Rohde&Schwarz service.



This option is not available for the R&S ZNLE.

For models R&S ZNL14 and R&S ZNL20, operation with a single Li-ion battery is not supported.

For safety information, see "[Handling batteries safely](#)" on page 15.

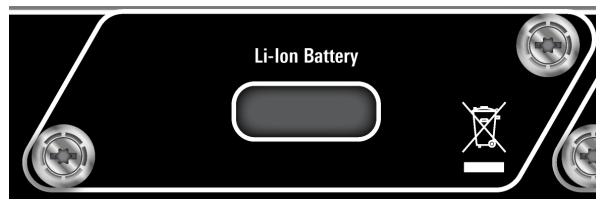

Charging batteries

Charge the batteries before using battery operation for the first time. Following a long storage period, it can be necessary to charge and discharge the batteries several times to reach full capacity.

For batteries from third parties, follow the instructions provided by the manufacturer. For batteries manufactured by Rohde & Schwarz, observe the following:

- If inserted in the R&S ZNL, batteries are charged via the common AC or DC power supply.
- You can also use the external battery charger R&S FSV-B34 to charge up to 4 batteries.
- Charge in a temperature range from +0 °C to +45 °C. If the temperature is above or below these values, or the temperature varies strongly, charging is interrupted. If the battery temperature rises above +53 °C, charging is stopped.
- Try not to overcharge the battery too often because overcharging reduces the service life of the battery.



When the battery is being charged in standby mode, the [Power] LED blinks. During operation, the status bar indicates that the battery is being charged.

Remote command to determine the battery charge state:

`DIAGnostic:SERVice:BATTery:LEVel?` on page 571

Spare battery pack (R&S FPL1-Z4)

In addition to the internal battery pack (option R&S FPL1-B31), spare batteries are available for the R&S ZNL. The spare battery pack R&S FPL1-Z4 comprises two additional Li-ion batteries.

Outside the R&S ZNL, batteries can be charged using the external battery charger R&S FSV-B34. Even during battery operation, you can exchange the internal batteries while the R&S ZNL is running, as long as one battery remains in the instrument. However, it is not recommended to operate the R&S ZNL with only one battery for a longer period.



This option is not available for the R&S ZNLE.

For models R&S ZNL14 and R&S ZNL20, operation with a single Li-ion battery is not supported.

4.1.6 Switching On or Off

Table 4-1: Overview of power states

Status	LED on Power key	Position of main power switch
Off	● gray	[0]
Standby	● orange	[1]
Ready	● green	[1]

To switch on the R&S ZNL/ZNLE

The R&S ZNL/ZNLE is off but connected to power.

1. Set the switch on the power supply to position [1].
See [Chapter 4.2.2.1, "AC Power Supply Connection and Main Power Switch"](#), on page 47.

The LED of the Power key is orange.

See [Chapter 4.2.1.2, "Power Key"](#), on page 41.

2. Press the Power key.

The LED changes to green.

The instrument operates on battery, DC, or AC power, whichever is supplied. The R&S ZNL/ZNLE boots.

After booting, the instrument is ready for operation.

To shut down the product

The product is in the ready state.

- ▶ Press the [Power] key.

The operating system shuts down. The LED changes to orange.

To disconnect from power

The R&S ZNL/ZNLE is in the standby state.

1. **NOTICE!** Risk of data loss. If you disconnect the product from power when it is in the ready state, you can lose settings and data. Shut it down first.

Set the switch on the power supply to position [0].

See [Chapter 4.2.2.1, "AC Power Supply Connection and Main Power Switch"](#), on page 47.

The LED of the standby key is switched off.

2. Disconnect the R&S ZNL/ZNLE from the power source.

4.1.7 Connecting to LAN

You can connect the instrument to a LAN for remote operation via a PC.

Provided the network administrator has assigned you the appropriate rights and adapted the Windows firewall configuration, you can use the interface, for example:

- To transfer data between a controlling device and the test device, e.g. to run a remote control program
- To access or control the measurement from a remote computer using the "Remote Desktop" application (or a similar tool)
- To connect external network devices (e.g. printers)
- To transfer data from a remote computer and back, e.g. using network folders

Network environment

Before connecting the product to a local area network (LAN), consider the following:

- Install the latest firmware to reduce security risks.
- For internet or remote access, use secured connections, if applicable.
- Ensure that the network settings comply with the security policies of your company. Contact your local system administrator or IT department before connecting your product to your company LAN.
- When connected to the LAN, the product may potentially be accessed from the internet, which may be a security risk. For example, attackers might misuse or damage the product. For more information about IT security and how to operate the product in a secure LAN environment, see the Rohde & Schwarz white paper [1EF96: Malware Protection Windows 10](#).

- ▶ **NOTICE!** Risk of network failure.

Consult your network administrator before performing the following tasks:

- Connecting the instrument to the network
- Configuring the network
- Changing IP addresses
- Exchanging hardware

Errors can affect the entire network.

Connect the R&S ZNL/ZNLE to the LAN via the LAN interface on the rear panel of the instrument.

Windows automatically detects the network connection and activates the required drivers.

By default, the R&S ZNL/ZNLE is configured to use DHCP and no static IP address is configured.



The default instrument name is <Type><variant>-<serial_number>, for example, ZNL3-123456. For information on determining the serial number, see [Chapter 4.2.2.14, "Device ID"](#), on page 52.

For more information on LAN configuration, see the R&S ZNL/ZNLE user manual.

4.1.8 Connecting a Keyboard

The keyboard is detected automatically when it is connected. The default input language is English – US.

However, you can also connect foreign language keyboards; currently the following languages are supported for the R&S ZNL/ZNLE:

- German
- Swiss
- French
- Russian

To configure the keyboard language

1. To access the Windows operating system, press the Windows key on the external keyboard.
2. Select "Start > Settings > Time & language > Region & language > Add a language" .

4.1.9 Connecting an External Monitor

You can connect an external monitor (or projector) to the "DVI" connector on the rear panel of the R&S ZNL/ZNLE (see also [Chapter 4.2.2.13, "DVI"](#), on page 51).



Screen resolution and format

The touchscreen of the R&S ZNL/ZNLE is calibrated for a 16:10 format. If you connect a monitor or projector using a different format (e.g. 4:3), the calibration is not correct and the screen does not react to your touch actions properly.

The touchscreen has a screen resolution of 1280x800 pixels. Usually, the display of the external monitor is a duplicate of the instrument's monitor.

If you configure the external monitor to be used as the *only* display in the Windows configuration dialog box ("Show only on 2"), the maximum screen resolution of the monitor is used. In this case, you can maximize the R&S ZNL/ZNLE application window and see even more details. You cannot change the monitor's screen resolution via the standard Windows configuration dialog box.

The R&S ZNL/ZNLE supports a minimum resolution of 1280x768 pixels.

1. Connect the external monitor to the R&S ZNL/ZNLE.
2. Press the [Setup] key.
3. Press the "Display" softkey.
4. Select the "Configure Monitor" tab in the "Display" dialog box.

The standard Windows "Screen Resolution" dialog box is displayed.

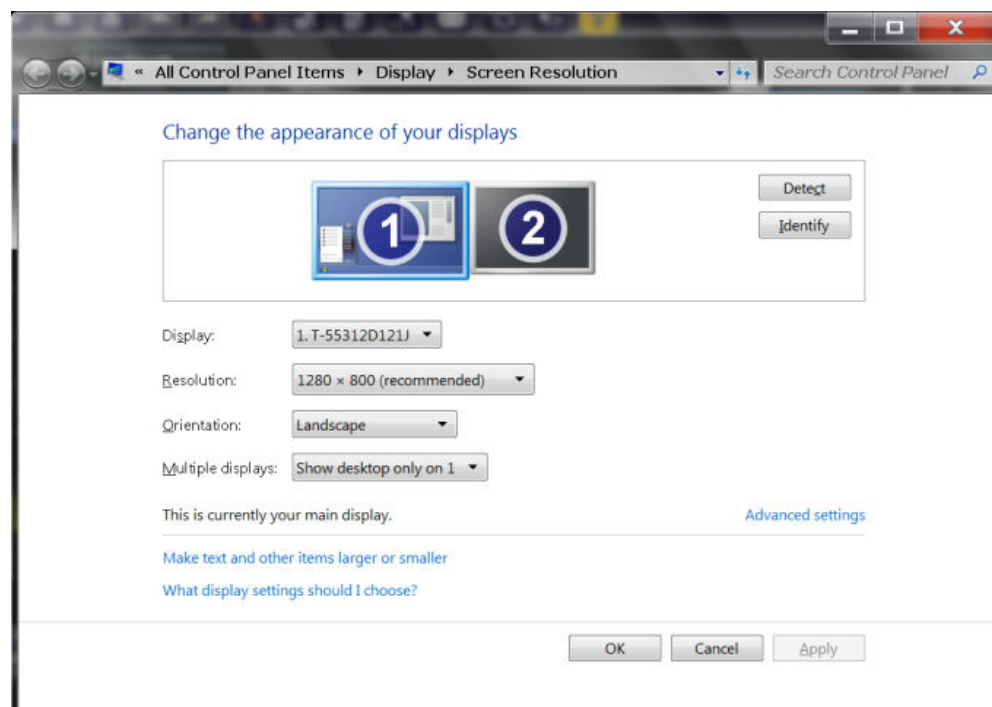

5. If necessary, change the screen resolution. Consider the information in the note above.
6. Select the instrument for display:
 - "Display 1" : internal monitor only
 - "Display 2" : external monitor only

- "Duplicate" : both internal and external monitor
7. Tap "Apply" to try out the settings before they are accepted permanently, then you can easily return to the previous settings, if necessary.
 8. Select "OK" if the settings are suitable.

Fixing a wrong touchscreen mapping

For instruments that are equipped with a system image version < 0.8, the touchscreen function is erroneously mapped to the external monitor by default. This mismatch is particularly inconvenient in extended display mode, where touch gestures on the instrument screen actually operate on the external screen. In duplicate monitor mode, touch screen operation also malfunctions if the resolutions of the internal and external display do not match.

To fix the mapping between touchscreen and display, connect an external monitor to the R&S ZNL/ZNLE and proceed as follows:

1. Select [Setup] > "Display" > "Configure Monitor" > "Display Switch" to bring up the Windows 10 "PROJECT" notification window.
Or press [Win]+[P] on a connected keyboard.
2. Select "Extend".
3. In the Windows task bar, search for "tablet" and select "Tablet PC Settings"
4. In the "Tablet PC Settings" dialog, select "Setup...". Enter the administrator password to proceed.
Observe the message "Touch this screen to identify it as the touchscreen" on the **internal** touch screen.
5. Tap on the internal touch screen.
6. Press [ENTER].
Observe the message "Touch this screen to identify it as the touchscreen" on the **external** screen.
7. If the external monitor is also a touchscreen, tap on it.
8. Press [ENTER].
Touch screen operation functions correctly now. Use the "PROJECT" flyout again to select the appropriate display mode.



Refer to the "Versions + Options" tab of the [Setup] > "System Configuration" dialog to determine the "Image" version of your instrument.

4.1.10 Windows Operating System

The instrument contains the Windows operating system which has been configured according to the instrument's features and needs. Changes in the system setup are

only required when peripherals like a keyboard or a printer are installed or if the network configuration does not comply with the default settings. After the R&S ZNL/ZNLE is started, the operating system boots and the instrument firmware is started automatically.

Tested software

The drivers and programs used on the instrument under Windows are adapted to the instrument. Only install update software released by Rohde & Schwarz to modify existing instrument software.

You can install additional software on the instrument; however, additional software can impair instrument function. Thus, run only programs that Rohde & Schwarz has tested for compatibility with the instrument software.

The following program packages have been tested:

- Symantec Endpoint Security – virus-protection software
- FileShredder - for reliable deletion of files on the hard disk

Service packs and updates

Microsoft regularly creates security updates and other patches to protect Windows-based operating systems. These are released through the Microsoft Update website and associated update server. Instruments using Windows, especially those that connect to a network, should be updated regularly.

Firewall settings

A firewall protects an instrument by preventing unauthorized users from gaining access to it through a network. Rohde & Schwarz highly recommends the use of the firewall on your instrument. Rohde & Schwarz instruments are shipped with the Windows firewall enabled and preconfigured in such a way that all ports and connections for remote control are enabled.

Note that changing firewall settings requires administrator rights.

Virus protection

Take appropriate steps to protect your instruments from infection. Use strong firewall settings and scan any removable storage device used with a Rohde & Schwarz instrument regularly. It is also recommended that you install anti-virus software on the instrument. Rohde & Schwarz does NOT recommend running anti-virus software in the background ("on-access" mode) on Windows-based instruments, due to potentially degrading instrument performance. However, Rohde & Schwarz does recommend running it during non-critical hours.

For details and recommendations, see the following Rohde & Schwarz white paper:

- [1EF96: Malware Protection Windows 10](#)

To access the "Start" menu

The Windows "Start" menu provides access to the Windows functionality and installed programs.



- ▶ Select the "Windows" icon in the toolbar, or press the "Windows" key or the [CTRL + ESC] key combination on the (external) keyboard.

The "Start" menu and the Windows taskbar are displayed.



The Windows taskbar also provides quick access to commonly used programs, for example Paint or WordPad. IECWIN, the auxiliary remote control tool provided free of charge and installed by Rohde & Schwarz, is also available from the taskbar or "Start" menu.

For details on the IECWIN tool, see the "Network and Remote Control" chapter of the R&S ZNL/ZNLE user manual.

All necessary system settings can be defined in the "Start > Settings" menu.

For required settings, refer to the Windows documentation and to the hardware description.

4.1.11 Logging On

Windows requires that users identify themselves by entering a user name and password in a login window. By default, the R&S ZNL/ZNLE provides two user accounts:

- **"Instrument"**: a standard user account with limited access
- **"Administrator"**: an administrator account with unrestricted access to the computer/domain

Some administrative tasks require administrator rights (e.g. the configuration of a LAN network). Refer to the description of the basic instrument Setup ([Setup] menu) to find out which functions are affected.

Passwords

For all default user accounts, the initial password is **894129**. Note that this password is very weak, and it is recommended that you change the password for both users after initial login. An administrator can change the password in Windows for any user at any time via "Start > Settings > Account > SignIn Options > Password > Change".

Auto-login

When shipped, the instrument automatically logs on the default "Instrument" user to Windows using the default password. This function is active until an administrator explicitly deactivates it or changes the password.



Changing the password and use of auto-login function

Note that when you change the default password, the default auto-login function no longer works!

In this case, you must enter the new password manually to log on.

Adapting the auto-login function to a new password

If you change the password that is used during auto-login, this function no longer works. Adapt the settings for the auto-login function first.

1. Open the
`C:\Users\Public\Documents\Rohde-Schwarz\ZNL\user\user\AUTOLOGIN.REG` file in any text editor (e.g. Notepad).
2. In the line `"DefaultPassword"="894129"`, replace the default password (894129) by the new password for automatic login.
3. Save the changes to the file.
4. In the Windows "Start" menu, select "Run".
The "Run" dialog box is displayed.
5. Enter the command
`C:\Users\Public\Documents\Rohde-Schwarz\ZNL\user\user\AUTOLOGIN.REG`.
6. Press the [ENTER] key to confirm.
The auto-login function is reactivated with the changed password. It will be applied the next time the instrument is switched on.

Switching users when using the auto-login function

Which user account is used is defined during login. If auto-login is active, the login window is not displayed. However, you can switch the user account to be used even when the auto-login function is active.



1. Select the "Windows" icon in the toolbar to access the operating system of the R&S ZNL/ZNLE (see also ["To access the "Start" menu"](#) on page 36).
2. Press [CTRL] + [ALT] + [DEL], then select "Sign out".
The "Login" dialog box is displayed, in which you can enter the different user account name and password.

For information on deactivating and reactivating the auto-login function, see ["Deactivating the auto-login function"](#) on page 175.

4.1.12 Checking the Supplied Options

The instrument can be equipped with both hardware and firmware options. To check whether the installed options correspond to the options indicated on the delivery note, proceed as follows.

1. Press the [SETUP] key.
2. Press the "System Config" softkey.
3. Switch to the "Versions + Options" tab in the "System Configuration" dialog box.
A list with hardware and firmware information is displayed.
4. Check the availability of the hardware options as indicated in the delivery note.

4.1.13 Considerations for Test Setup

Cable selection and electromagnetic interference (EMI)

Electromagnetic interference (EMI) can affect the measurement results.

To suppress electromagnetic radiation during operation:

- Use high-quality shielded cables, for example, double-shielded RF and LAN cables.
- Always terminate open cable ends.
- Ensure that connected external devices comply with EMC regulations.

Preventing electrostatic discharge (ESD)

Electrostatic discharge is most likely to occur when you connect or disconnect a DUT.

- ▶ **NOTICE!** Risk of electrostatic discharge. Electrostatic discharge can damage the electronic components of the product and the device under test (DUT).

Ground yourself to prevent electrostatic discharge damage:

- a) Use a wrist strap and cord to connect yourself to ground.
- b) Use a conductive floor mat and heel strap combination.

NOTICE

Instrument damage caused by electrostatic discharge

If you are working in an environment where strong ESD discharges are possible, for additional protection Rohde & Schwarz recommends using broadband limiters R&S ZN-B13 (stock number 1303.7840.02) at each port of your R&S ZNL/ZNLE3|4|6.

Signal input and output levels

Information on signal levels is provided in the data sheet. Keep the signal levels within the specified ranges to avoid damage to the R&S ZNL/ZNLE and connected devices.

4.2 Instrument Tour

4.2.1 Front Panel View

This chapter describes the front panel, including all function keys and connectors.



Figure 4-1: Front panel view

- 1 = Power key
- 2 = USB (2.0) connectors
- 3 = System keys
- 4 = Touchscreen
- 5 = Function keys
- 6 = Keypad
- 7 = Navigation controls
- 8 = Port 1
- 9 = Port 2 / RF input 50 Ω connector

4.2.1.1 Touchscreen

All measurement results are displayed on the screen on the front panel. Additionally, the screen display provides status and setting information and allows you to switch between various measurement tasks. The screen is touch-sensitive, offering an alternative means of user interaction for quick and easy handling of the instrument.

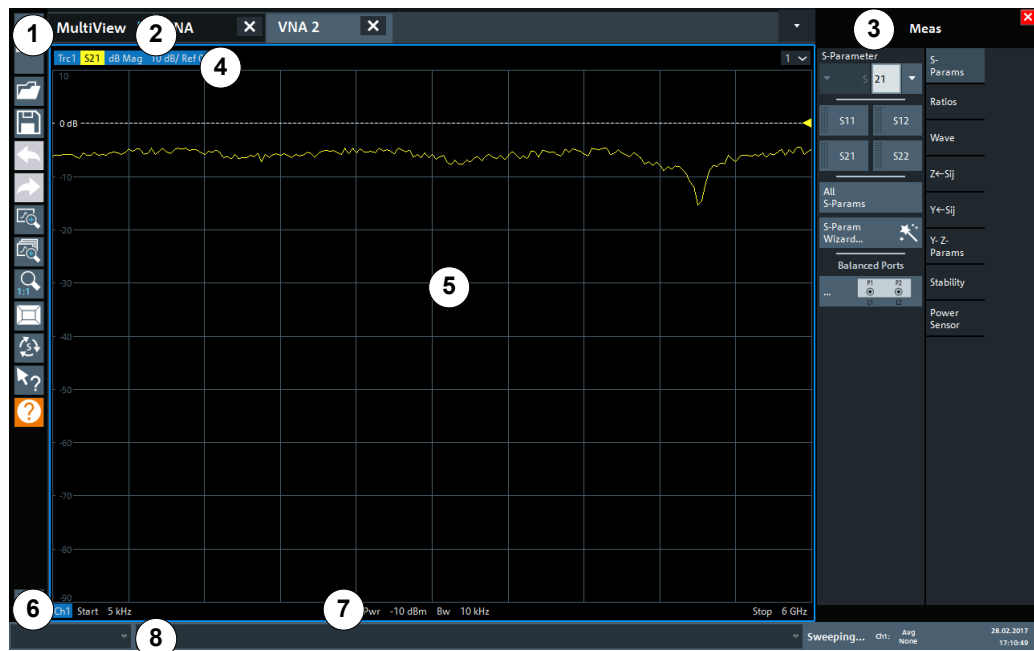

Figure 4-2: Touchscreen elements

- 1 = Toolbar with standard application functions, e.g. print, save/open file etc.
- 2 = Tabs for individual channel setups
- 3 = Softtool panel (a.k.a. softkey bar)
- 4 = Window title bar with diagram-specific (trace) information
- 5 = Measurement results (diagram) area
- 6 = Channel list
- 7 = Diagram footer with diagram-specific information
- 8 = Instrument status bar for error messages and date/time display

Using touchscreen gestures, you can perform the following tasks (among others).

(See [Chapter 4.3, "Trying Out the Instrument"](#), on page 52)

- Changing a setting
- Changing the display
- Changing the displayed result range in a diagram
- Moving a marker
- Zooming into a diagram
- Selecting a new evaluation method
- Scrolling through a result list or table
- Saving or printing results and settings

To imitate a right-click by mouse using the touchscreen, for example to open a context-sensitive menu for a specific item, press the screen for about 1 second.

For details on touchscreen gestures, see [Chapter 4.4.4, "Touchscreen Gestures"](#), on page 81.

4.2.1.2 Power Key

The [Power] key is located on the lower left corner of the front panel. It starts up and shuts down the instrument.

See also "[Connecting to power](#)" on page 14 and [Chapter 4.1.5, "Connecting to Power"](#), on page 27.

4.2.1.3 USB

The front panel provides two female USB connectors (USB-A, 2.0 standard) to connect devices like a keyboard or a mouse. A memory stick can be connected to store and reload instrument settings and measurement data.

The rear panel provides further USB connectors (standard 3.0), see [Chapter 4.2.2.11, "USB"](#), on page 51.

4.2.1.4 System Keys

System keys set the instrument to a predefined state, change basic settings, and provide print and display functions.

A detailed description of the corresponding functions is provided in the R&S ZNL/ZNLE user manual.

Table 4-2: System keys

System key	Assigned functions
[Preset]	Resets the instrument to the default state.
[Setup]	Provides basic instrument configuration functions, e.g.: <ul style="list-style-type: none"> • Reference frequency (external/internal) • Date, time, display configuration • LAN interface • Firmware update and enabling of options • Information about instrument configuration incl. firmware version and system error messages • Service support functions (self-test etc.) • Self-alignment (with spectrum analysis option) R&S ZNL only!
[Mode]	Manages channel setups
[Print]	Provides configuration settings for the print function
[FILE]	Provides save/recall functions for instrument settings and measurement results
	Switches between the on-screen keyboard display: <ul style="list-style-type: none"> • At the top of the screen • At the bottom of the screen • Off

4.2.1.5 Function Keys

Function keys provide access to the most common measurement settings and functions.

A detailed description of the corresponding functions is provided in the R&S ZNL/ZNLE user manual.



The labels indicated in *italics* (blue font color on the instrument) apply to the optional Spectrum mode only.

This option is not available for the R&S ZNLE.

Table 4-3: Function keys

Function key	Assigned functions	
	VNA mode	SA mode (R&S ZNL only)
[Freq]	Defines the sweep range.	Sets the center frequency and the start and stop frequencies for the frequency range under consideration. This key is also used to set the frequency offset and the signal track function.
[Span]		Sets the frequency span to be analyzed
[Scale] <i>[Ampt]</i>	Defines the scaling and zooming of diagrams.	Sets the reference level, the displayed dynamic range, the RF attenuation and the unit for the level display Sets the level offset and the input impedance
[Mkr]	Defines and positions absolute and relative measurement markers (markers and delta markers). Selects special marker functions	
[Mkr->]	Used for search functions of the measurement markers (maximum/minimum of the trace). Assigns the marker frequency to the center frequency, and the marker level to the reference level. Restricts the search area (Search Limits) and characterizes the maximum points and minimum points (Peak Excursion).	
[Bw Avg Power]	Defines the power of the internal signal sources, selects the receiver step attenuators (optional, R&S ZNL only!) and the IF bandwidths, and sets up averaging.	Sets the resolution bandwidth and the video bandwidth.
[Sweep]	Defines the sweep type and other sweep parameters; controls sweep execution.	Sets the sweep time and the number of measurement points Selects continuous measurement or single measurement
[Trace]	Configures the graphical analysis of measurement results.	
[Trig]	Defines how measurement sweeps are triggered.	Sets the trigger mode, the trigger threshold, the trigger delay, and the gate configuration for gated sweep

Function key	Assigned functions	
	VNA mode	SA mode (R&S ZNL only)
[Offset Embed]	Contains functions for deembedding/ embedding the DUT from/into physical/ virtual (matching) networks placed between the calibrated reference plane and the DUT.	Performs a peak search for active marker. If no marker is active, normal marker 1 is activated and the peak search is performed for it.
[Meas]	Selects the quantities to be measured and displayed.	
[Format] [Config]	Selects the trace format (dB magnitude, Smith, etc.).	Configure measurements and data input and output
[Display Lines]	Configures display lines and limit lines.	
[Cal] [Single]	Provides all functions related to system error calibration.	Starts and stops a single new measurement (Single Sweep Mode)
[Channel] [Cont]	Creates and deletes channel setups and optimize the measurement process.	Starts and stops a continuous measurement (Continuous Sweep Mode)

4.2.1.6 Keypad

The keypad is used to enter numeric parameters, including the corresponding units. It contains the following keys:

Table 4-4: Keys on the keypad

Type of key	Description
Decimal point	Inserts a decimal point "." at the cursor position.
Sign key	Changes the sign of a numeric parameter. For alphanumeric parameters, inserts a "-" at the cursor position.
Unit keys (G/n, M/ μ , k/m, x1)	Adds the selected unit to the entered numeric value and complete the entry. For level entries (e.g. in dB) or dimensionless values, all units have the value "1" as multiplying factor. Thus, they have the same function as an [ENTER] key.
[ESC]	Closes all kinds of dialog boxes, if the edit mode is not active. Quits the edit mode, if the edit mode is active. In dialog boxes that contain a "Cancel" button it activates that button. For "Edit" dialog boxes the following mechanism is used: <ul style="list-style-type: none"> • If data entry has been started, it retains the original value and closes the dialog box. • If data entry has not been started or has been completed, it closes the dialog box.

Type of key	Description
 (BACKSPACE)	If an alphanumeric entry has already been started, this key deletes the character to the left of the cursor.
[ENTER]	<ul style="list-style-type: none"> Concludes the entry of dimensionless entries. The new value is accepted. With other entries, this key can be used instead of the "Hz/dB" unit key. In a dialog box, selects the default or focused element.

4.2.1.7 Navigation Controls

The navigation controls include a rotary knob and navigation keys. They allow you to navigate within the display or within dialog boxes.



Navigating in tables

The easiest way to navigate within tables (both in result tables and configuration tables) is to scroll through the entries with your finger on the touchscreen.

Rotary Knob



The rotary knob has several functions:

- For numeric entries: increments (clockwise direction) or decrements (counter-clockwise direction) the instrument parameter at a defined step width
- In lists: toggles between entries
- For markers, limit lines, and other graphical elements on the screen: moves their position
- For active scroll bars: moves the scroll bar vertically
- For dialog boxes: Same effect as the Enter key when pressed

Navigation Keys

The navigation keys can be used alternatively to the rotary knob to navigate through dialog boxes, diagrams or tables.

Arrow Up/Arrow Down Keys

The <arrow up> or <arrow down> keys do the following:

- For numeric entries: increments (Arrow Up) or decrements (Arrow Down) the instrument parameter at a defined step width
- In a list: scrolls forward and backward through the list entries
- In a table: moves the selection bar vertically
- In windows or dialog boxes with a vertical scroll bar: moves the scroll bar

Arrow Left/Arrow Right Keys

The <arrow left> or <arrow right> keys do the following:

- In an alphanumeric edit dialog box, move the cursor.
- In a list, scroll forward and backward through the list entries.
- In a table, move the selection bar horizontally.
- In windows or dialog boxes with horizontal scroll bar, move the scroll bar.

4.2.1.8 Port 1 and Port 2



Numbered RF connectors

- 3.5 mm (m) for R&S ZNL20
- N (f) for other models

The test ports serve as outputs for the RF stimulus signal and as inputs for the measured RF signals from the DUT (response signals).

- With a single test port, it is possible to generate a stimulus signal and measure the response signal in reflection. For a measurement example, refer to [Chapter 4.3.1.2, "Reflection S-Parameter Measurement"](#), on page 58.
- With 2 test ports, it is possible to perform full two-port measurements; see [Chapter 9.3.1, "S-Parameters"](#), on page 218.

NOTICE

Maximum input levels

The maximum input levels at all test ports according to the front panel labeling or the data sheet must not be exceeded.

In addition, the maximum input voltages of the other input connectors at the rear panel must not be exceeded.



It is recommended that you use a torque wrench when screwing RF cables on the test port connectors.



In Spectrum mode or any other application (R&S ZNL only), Port 2 is used as [RF INPUT 50 Ohm](#).

Port 1 is used to provide an independent CW output signal, if option R&S ZNL/ZNLE-K14 is installed and active.

4.2.1.9 RF INPUT 50 Ohm

Provides RF input from a connected device under test (DUT) to the R&S ZNL, which is then analyzed in an RF measurement. Connect the DUT to the "RF Input" on the R&S ZNL via a cable equipped with an appropriate connector. Do not overload the input. For maximum allowed values, see the data sheet.



For the R&S ZNLE, the Spectrum mode is not available and hence this connector is always used as VNA port 2.

See also [Chapter 4.1.13, "Considerations for Test Setup"](#), on page 38.

4.2.2 Rear Panel View

This figure shows the rear panel view of the R&S ZNL/ZNLE. The individual elements are described in more detail in the subsequent sections.

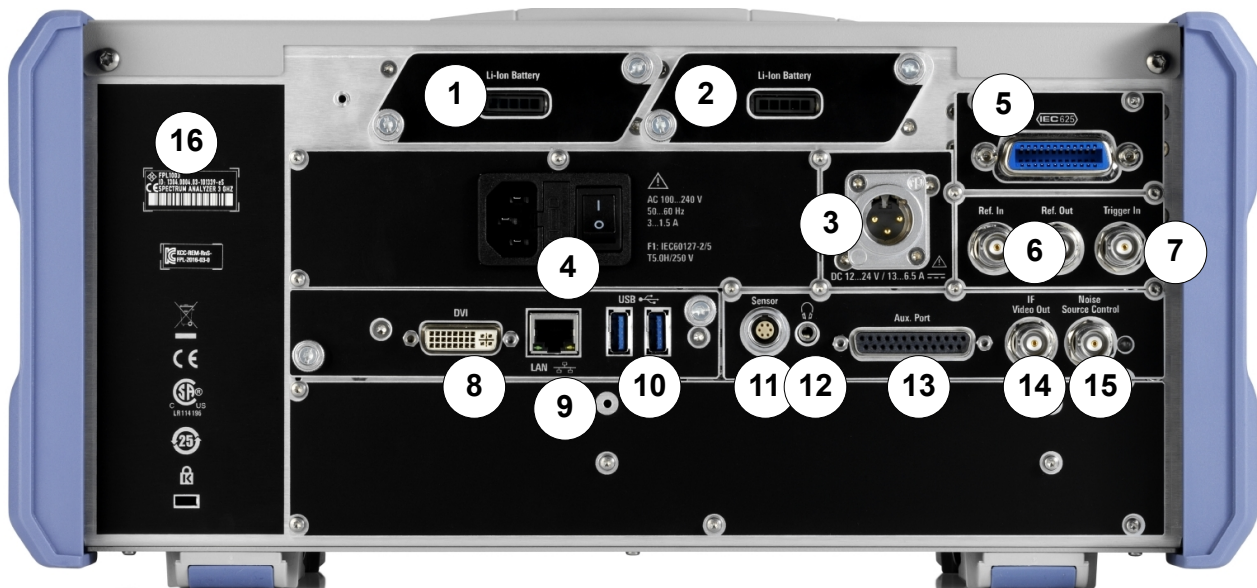

Figure 4-3: Rear panel view R&S ZNL

- 1+2 = Removable, rechargeable Li-ion batteries
- 3 = DC power supply
- 4 = AC power supply connection and main power switch with fuse
- 5 = GPIB (IEC 625) interface
- 6 = Reference clock connectors
- 7 = Trigger input connector
- 8 = "DVI" connector for external display
- 9 = "LAN" connector
- 10 = "USB" (3.0) connectors
- 11 = NRP power sensor connector *)
- 12 = Headphones connector *)
- 13 = Aux. Port serving as VNA user port or SA auxiliary port *)
- 14 = "IF/VIDEO OUT" connector *)
- 15 = NOISE SOURCE CONTROL *)

*) requires the "Additional Interfaces" option R&S FPL1-B5.



Figure 4-4: Rear panel view R&S ZNLE

- 1 = AC power supply connection and main power switch
- 2 = GPIB ("IEC") interface
- 3 = Reference clock connectors
- 4 = Trigger input connector
- 5 = "DVI" connector for external display
- 6 = "LAN" connector
- 7 = "USB" (3.0) connectors



The meanings of the labels on the R&S ZNL/ZNLE are described in [Chapter 1.2, "Labels on R&S ZNL/ZNLE"](#), on page 16.

4.2.2.1 AC Power Supply Connection and Main Power Switch

An AC power supply connector and main power switch are located in a unit on the rear panel of the instrument.

Main power switch function:

Position 1: The instrument is in operation.

Position O: The entire instrument is disconnected from the AC power supply.

For details, refer to ["Connecting to power"](#) on page 14 and [Chapter 4.1.5, "Connecting to Power"](#), on page 27.

4.2.2.2 Li-Ion Battery Packs and DC Power Connector

With the Li-ion battery pack (option R&S FPL1-B31), the R&S ZNL can be operated independently of an AC or DC power supply. The instrument can house 2 Li-ion batteries which can be charged both via AC or DC power supply.

For safety information concerning batteries, see ["Handling batteries safely"](#) on page 15.

As an alternative, a DC power supply connector (option R&S FPL1-B30) is available. DC power supplies from +12 V to +24 V and from 13 A to 6.5 A can be used. Connect the connector according to the following diagram:

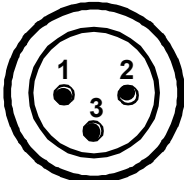
	Pin	Description
	1	Plus
	2	Ground
	3	Not used



These options are not available for the R&S ZNLE.

If you use an external power supply unit to supply safety extra-low DC voltage (SELV) to the instrument, be sure to meet the requirements for reinforced/double insulation in accordance with DIN/EN/IEC 61010 (UL 3111, CSA C22.2 No. 1010.1) or DIN/EN/IEC 60950 (UL 1950, CSA C22.2 No. 950). Provide current limitation in accordance with DIN EN 61010-1 Appendix F2.1.

Also see ["Connecting to power"](#) on page 14.

4.2.2.3 GPIB Interface

The optional GPIB interface (R&S FPL1-B10) is in compliance with IEEE488 and SCPI. A computer for remote control can be connected via this interface. To set up the connection, a shielded cable is recommended.

For details, see "Interfaces and Connectors" in the appendix of the user manual or online help.

For details, see [Chapter 15.3.2, "GPIB Interface"](#), on page 1016.

4.2.2.4 Ref. In / Ref. Out

The Ref. In connectors are used to provide an external reference signal to the R&S ZNL/ZNLE.

The Ref. Out connectors can be used to provide a reference signal from the R&S ZNL/ZNLE to other devices that are connected to this instrument.

Various connectors are provided for different reference signals:

Connector	Reference signal	Usage
Ref. In	10 MHz 10 dBm	To provide an external reference signal on the R&S ZNL/ZNLE.
Ref. Out	10 MHz 10 dBm	To provide the internal reference signal from the R&S ZNL/ZNLE to another device continuously. For the R&S ZNL, this is also used to provide the optional OCXO reference signal to another device.

4.2.2.5 Trigger In

Use the female Trigger In connector to input an external trigger or gate data. Thus, you can control the measurement using an external signal. The voltage level is 1.4 V. The typical input impedance is 10 kΩ.

4.2.2.6 Noise Source Control

The Noise Source Control female connector is used to provide the supply voltage for an external noise source. For example, use it to measure the noise figure and gain of amplifiers and frequency converting devices.



- This connector is provided by the "Additional Interfaces" option R&S FPL1-B5. This option is not available for the R&S ZNLE.
- The Noise Source Control interface is only functional in Spectrum mode (option R&S ZNL3|4|6-B1)

Conventional noise sources require a voltage of +28 V to be switched on and 0 V to be switched off. The output supports a maximum load of 100 mA.

4.2.2.7 IF/Video Output

The female BNC connector can be used for various outputs in the Spectrum application:

- Intermediate frequency (IF) output of approximately 20 MHz
- Video output (1V)

Which output is provided is defined in the software ("Overview" > "Output").



- This connector is provided by the "Additional Interfaces" option R&S FPL1-B5. This option is not available for the R&S ZNLE.
- The IF/Video Output interface is only functional in Spectrum mode (option R&S ZNL3|4|6-B1)
- Interruptions in analog output can occur if you switch between a VNA and a spectrum application, due to the separate hardware. In particular, if you run a sequence of measurements including both measurement types, switching between both modes can interrupt the signal from the output connector.

For details, see the R&S ZNL/ZNLE Spectrum Mode user manual.

4.2.2.8 Aux. Port

A 25-pole D-Sub connector used as an input and output for low-voltage TTL control signals. Can either be used as VNA user port (max. 3.3 V) or SA Aux. Port (max. 5 V). In the firmware GUI, this can be set via [Setup] > "System Config" > "Add Interfaces" > "Port Configuration".

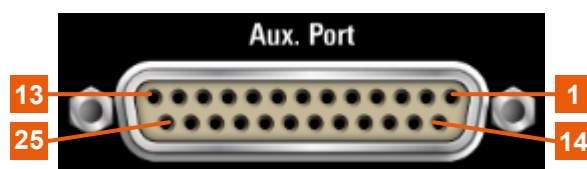

This connector is provided by the "Additional Interfaces" option R&S FPL1-B5. For details, see [Chapter 15.3.1.1, "Aux. Port"](#), on page 1014. This option is not available for the R&S ZNLE.

NOTICE

Short-circuit hazard

Always observe the designated pin assignment. A short-circuit can damage the port.

4.2.2.9 Headphones Connector

The Spectrum mode provides demodulators for AM, FM and PM signals, which can be routed to the headphone connector. With headphones or an external loudspeaker connected to the 3.5 mm headphone socket, the displayed signal can be identified acoustically.



- This connector is provided by the "Additional Interfaces" option R&S FPL1-B5. This option is not available for the R&S ZNLE.
- The headphones connector is only functional in Spectrum mode (option R&S ZNL3|4|6-B1). It can **not** be used to output sounds that are generated via Windows audio APIs. To hear those sounds, connect a USB audio device to the instrument or operate it via remote desktop.
- Interruptions in analog output can occur if you switch between a VNA and a spectrum application, due to the separate hardware. In particular, if you run a sequence of measurements including both measurement types, switching between both modes can interrupt the signal from the output connector.

Note the safety information provided in ["Connecting headphones"](#) on page 16.

For details, see the R&S ZNL/ZNLE Spectrum mode user manual.

4.2.2.10 Sensor Connector

The LEMOSA female connector is used to connect power sensors of the R&S NRP-Zxy family. For a detailed list of supported sensors, see the data sheet.



This connector is provided by the "Additional Interfaces" option R&S FPL1-B5. This option is not available for the R&S ZNLE.

4.2.2.11 USB

The rear panel provides two additional female USB (3.0 standard) connectors to connect devices like a keyboard, a mouse or a memory stick (see also [Chapter 4.2.2.11, "USB"](#), on page 51).

4.2.2.12 LAN

The R&S ZNL/ZNLE is equipped with a 1 GBit Ethernet IEEE 802.3u network interface with Auto-MDI(X) functionality. The assignment of the RJ-45 connector supports twisted-pair category 5 UTP/STP cables in a star configuration (UTP stands for *unshielded twisted pair*, and STP for *shielded twisted pair*).

For details, see [Chapter 8, "Network and Remote Settings"](#), on page 149.

4.2.2.13 DVI

You can connect an external monitor or other display device to the R&S ZNL/ZNLE via the DVI (Digital visual interface) connector to provide an enlarged display.

For details, see [Chapter 4.1.13, "Considerations for Test Setup"](#), on page 38.

4.2.2.14 Device ID

The unique device identifier is provided as a barcode sticker on the rear panel of the R&S ZNL/ZNLE.

It consists of the device order number and a serial number.



The serial number is used to define the **default instrument name**, which is:

<Type><variant>-<serial_number>

For example, ZNL3-123456.

The instrument name is required to establish a connection to the instrument in a LAN.

4.3 Trying Out the Instrument

This chapter introduces the most important functions and settings of the R&S ZNL/ZNLE step by step. The complete description of the functionality and its usage is given in the R&S ZNL/ZNLE User Manual. Basic instrument operation is described in [Chapter 4.4, "Operating the Instrument"](#), on page 73.

Prerequisites

- The instrument is set up, connected to the mains system, and started up as described in [Chapter 4.1, "Preparing for Use"](#), on page 24.
- [Performing Measurements](#).....52
- [Zooming into the Display](#).....59
- [Saving Settings](#).....60
- [Printing and Saving Results](#).....62
- [Activating Additional Channel Setups](#).....63
- [Trying Out Spectrum Mode](#).....65
- [Performing Sequential Measurements](#).....72

4.3.1 Performing Measurements

This chapter takes you through a sample session with a R&S ZNL/ZNLE network analyzer and describes basic operation tasks.

⚠ CAUTION**Safety considerations**

Before starting any measurement on your network analyzer, please note the instructions given in [Chapter 4.1, "Preparing for Use"](#), on page 24.



Use the "S-Parameter Wizard" accessible via [Meas] > "S-Params" > "S-Param Wizard..." to measure S-parameters in a straightforward way. The wizard provides a series of dialogs where you can select the test setup, screen configuration and measurement parameters, configure the essential channel settings and perform a guided calibration.

Measurement stages in the wizard

The individual dialogs of the "S-Parameter Wizard" correspond to the typical stages of any measurement:

1. Select the test setup.
2. Define port impedances.
3. Select the measurement parameters and the diagrams.
4. Define the sweep range.
5. Adjust the receiver and source settings (measurement bandwidth, source power).
6. Perform a calibration.

4.3.1.1 Transmission S-Parameter Measurement

In a transmission measurement, the analyzer transmits a stimulus signal to the input port of the device under test (DUT) and measures the transmitted wave at the DUT's output port. The trace settings allow you to select the measured quantities and display formats, depending on what you want to learn from the data. A minimum of two analyzer test ports are required for transmission measurements.

In the following example, the analyzer is set up for a two-port transmission measurement. A frequency sweep range is selected, the instrument is calibrated and the measurement result is analyzed using various display formats.

Connecting the Instrument for Transmission Measurements

To prepare a transmission measurement, you have to connect your DUT (which for simplicity we assume to have appropriate connectors) in-between a pair of analyzer test ports. It is recommended that you preset the R&S ZNL/ZNLE to start from a well-defined instrument state.

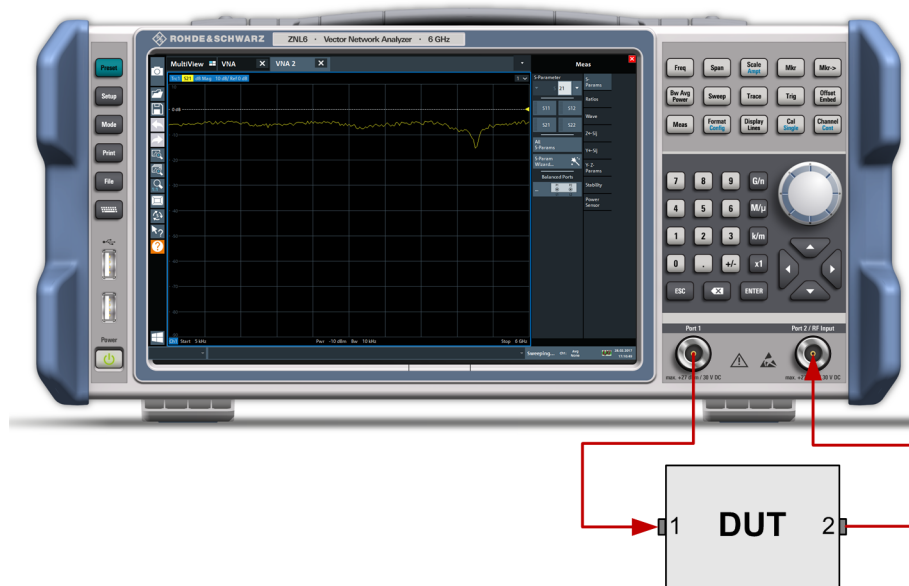

1. Connect the DUT between test ports 1 and 2 of the network analyzer as shown above.
2. Switch on the instrument and start the VNA application.
Proceed as described in [Chapter 4.1.6, "Switching On or Off"](#), on page 30.
3. Use the [Preset] key to restore a well-defined instrument state.
The analyzer is now set to its default state. The default measured quantity is the transmission S-parameter S_{21} .

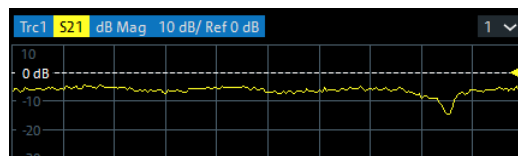

Select [Trace] and use the control elements in the "Traces" softtool tab if you wish to create additional traces and diagrams.

Selecting the Sweep Range and Other Parameters

After a system preset the display shows a diagram with a dB magnitude scale, and the S-parameter S_{21} is selected as a measured quantity. This S-parameter is the forward transmission coefficient of the DUT. It is defined as the ratio of the transmitted wave at the DUT's output port (port no. 2) to the incident wave at the DUT's input port (port no. 1).

The R&S ZNL/ZNLE automatically adjusts its internal source and receiver to the selected measured quantities: For an S_{21} measurement, a stimulus signal (termed a_1) is transmitted at the analyzer port no. 1; the transmitted wave (termed b_2) is measured at port 2. The stimulus signal from the analyzer port no. 2 is not needed except for some calibration types.

By default the sweep range is set to the frequency range of the analyzer, which can be unsuitable for your DUT. The following procedure shows you how to configure a smaller sweep range.

1. Select [Freq] and set the "Start Frequency" to the lowest frequency you want to measure (e.g. 1.77 GHz). For convenient data entry, double-tap/click the input field to open the "Numeric Editor".

Tip: If you use the keypad at the front panel for data entry, type [1][.][7][7] and terminate the entry with the [G/n] key.

Refer to [Chapter 4.4.3, "Entering Data"](#), on page 80 to learn more about entering numeric values and characters.

2. In the "Stop Frequency" input field, enter the highest frequency you want to measure (e.g. 2.5 GHz).
3. Select [Scale] > "Scale Values" and activate the "Auto Scale Trace" function. The analyzer adjusts the scale of the diagram to fit in the entire S_{21} trace, leaving an appropriate display margin.

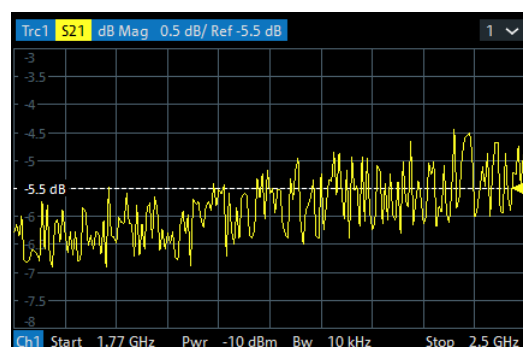

Calibrating the Instrument

Calibration (system error correction) is the process of eliminating systematic, reproducible errors from the measurement results. E.g., in the current test setup, the connecting cables between the analyzer ports and the DUT introduce an attenuation and a phase shift of the waves. Both effects impair the accuracy of the S-parameter measurement.

The analyzer provides a wide range of sophisticated calibration methods for all types of measurements. The calibration method to select depends on the expected system errors, the accuracy requirements of the measurement, on the test setup and on the types of calibration standards available.

The following example requires a calibration kit with a male Through standard with known transmission characteristics for the related test port connector type and gender. With a single Through, it is possible to perform a transmission normalization, compensating for a frequency-dependent attenuation and phase shift in the signal paths.

Due to the R&S ZNL/ZNLE's calibration wizard, calibration is a straightforward, guided process.

1. Replace the DUT by the Through standard of your calibration kit. Make sure to disconnect all calibration units.
2. Select [Cal] > "Start... (Manual)" to open the "Calibration Setting" wizard.
3. Select the port combination Port 1 (P1) and Port 2 (P2) and the calibration type "Trans Norm". Make sure to define port 1 as the source port.

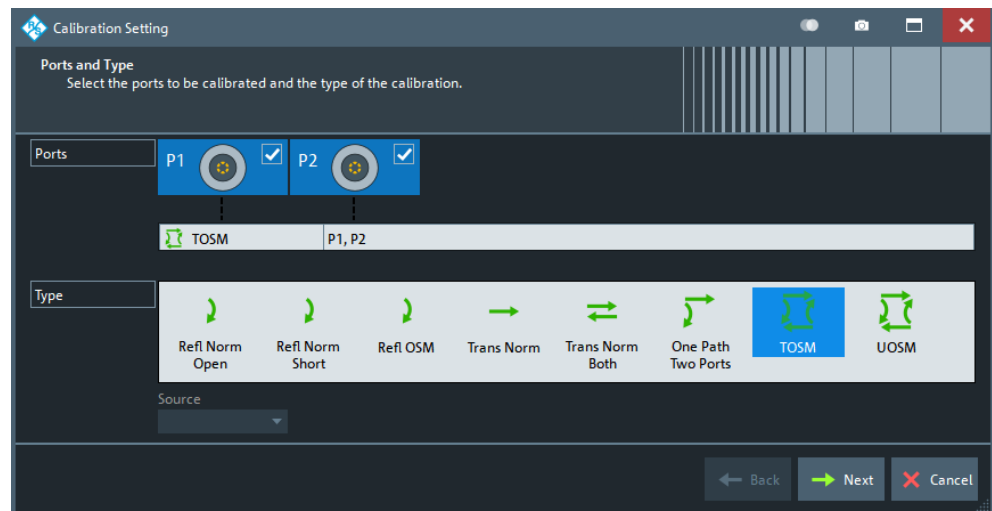

4. Select "Next" to proceed to the next page of the "Calibration Setting" wizard.
5. Select the test port connector type and gender (here: N 50 Ω , female, corresponding to a male Through standard), and the calibration kit (here: R&S ZV-Z121).

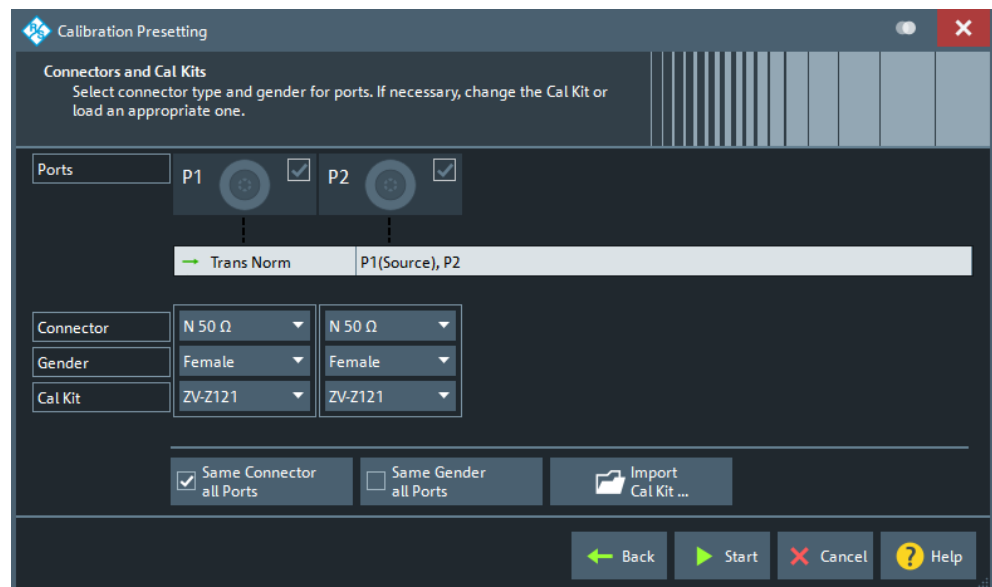

6. Tap "Start".

- The calibration dock widget indicates the standard measurements that make up a "Trans Norm" calibration.
Select "Through (mm)" to initiate the measurement of the connected Through standard. Measuring the isolation between ports 1 and 2 is optional. Skip it for now.

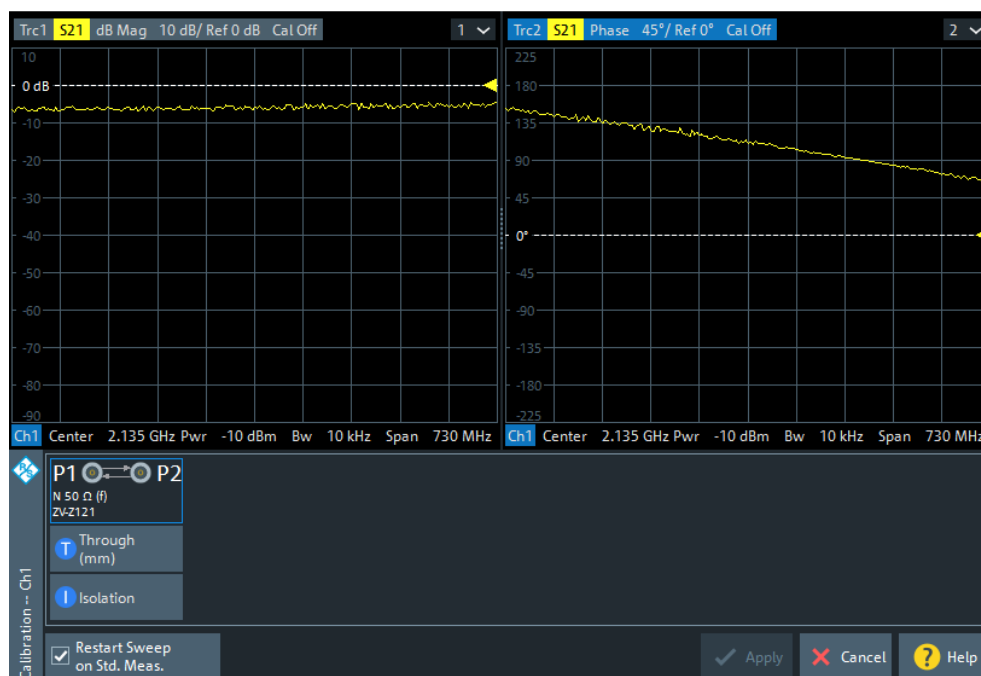

The analyzer performs a calibration sweep for the measured quantity S_{21} . The magnitude and phase of the result is displayed in two diagrams, together with the expected typical result for a Through standard. The similarity of real and expected traces indicates that the Through standard has been properly connected. After the R&S ZNL/ZNLE has completed the calibration sweep and calculated the correction data, the "Apply" button is enabled.

- Select "Apply" to close the wizard.

The system error correction is calculated and applied to the current channel. A "Cal" label appears in the trace list.

To proceed with the measurement, remove the Through standard and connect the DUT again.

Evaluating Data

The analyzer provides various tools to optimize the display and analyze the measurement data. For instance, you can use markers to determine maxima and minima on the trace, and change the display format to obtain information about the group delay of the transmitted wave.

- Select [Mkr] > [Mkr] > "Mkr 1".
This places marker "M1" to its default position (center of the sweep range). A marker symbol (triangle) appears on the trace, a marker info field in the upper right

corner of the diagram. The marker info field displays the stimulus value (frequency) and response value (magnitude of the transmission coefficient converted to a dB value) at the marker position.

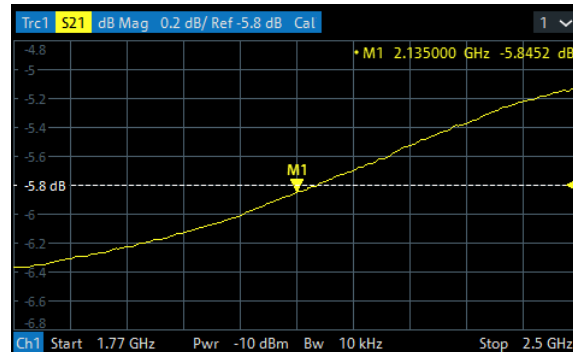

- Open the [Mkr->] > "Peak" softtool tab and activate "Min" search. The marker jumps to the absolute minimum of the curve in the entire sweep range. The marker info field shows the coordinates of the new marker position.
- Select [Format] and choose the "Delay" of the transmission coefficient as displayed quantity.

The group delay represents the propagation time of the wave through the DUT; it is displayed in a Cartesian diagram. The marker info field shows the frequency and group delay at the marker position.

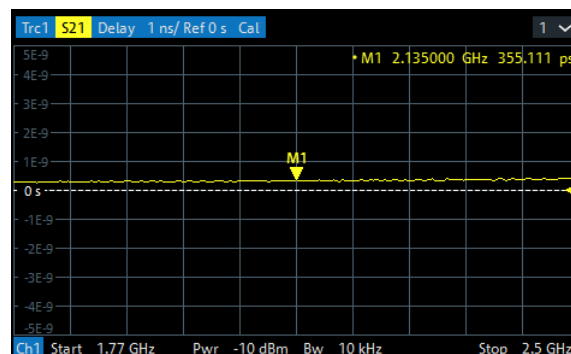

Refer to [Chapter 9.2.3, "Trace Formats"](#), on page 209 to learn more about the diagram properties.

4.3.1.2 Reflection S-Parameter Measurement

In a reflection measurement, the analyzer transmits a stimulus signal to the input port of the device under test (DUT) and measures the reflected wave. Different trace formats allow you to express and display the results, depending on what you want to learn from the data. Only one analyzer test port is required for reflection measurements.

In principle, a reflection measurement involves the same steps as a transmission measurement. Note the following differences:

- The basic test setup for reflection measurements involves a single DUT and analyzer port. For instance, you can connect the input of your DUT to port 1 of the analyzer as shown below.

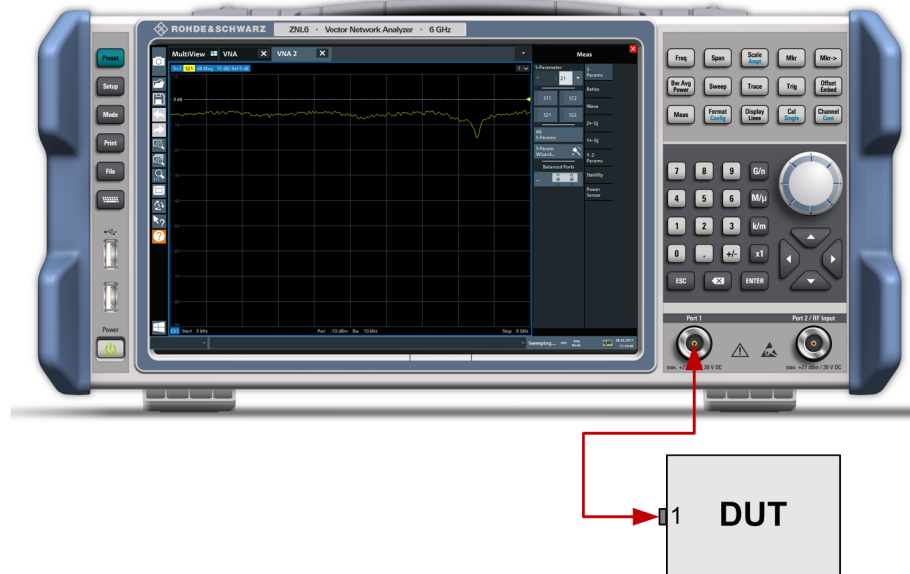

You can also use the basic transmission test setup, e.g. if you want to measure reflection and transmission parameters in parallel.

- The analyzer provides special calibration types for reflection measurements. Use the calibration wizard and select an appropriate type. The full 2-port calibration TOSM corrects the system errors for all transmission and reflection S-parameters.
- Some of the trace formats are particularly suited for reflection measurements. For instance, you can display the measured reflection coefficient S_{11} in a Smith chart to obtain the complex input impedance at port 1.

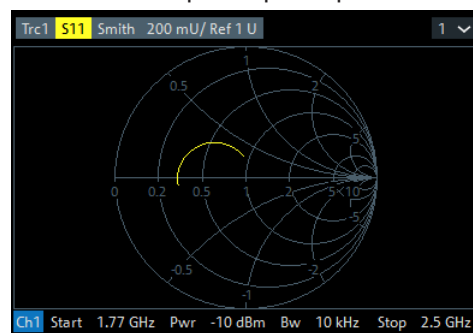

4.3.2 Zooming into the Display

To analyze the areas around the peak levels in more detail, we will zoom into a peak.



1. Tap the "Multiple Zoom" icon in the toolbar.
The icon is highlighted to indicate that zoom mode is active.
2. Tap the diagram near the peak and drag your finger to the opposite corner of the zoom area. A white rectangle is displayed from the point where you tapped to the current position.

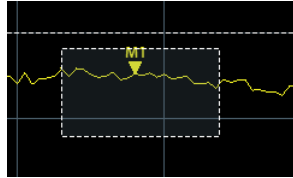

Figure 4-5: Defining the zoom area

When you remove your finger, the zoom area is enlarged in a second (sub-)window.

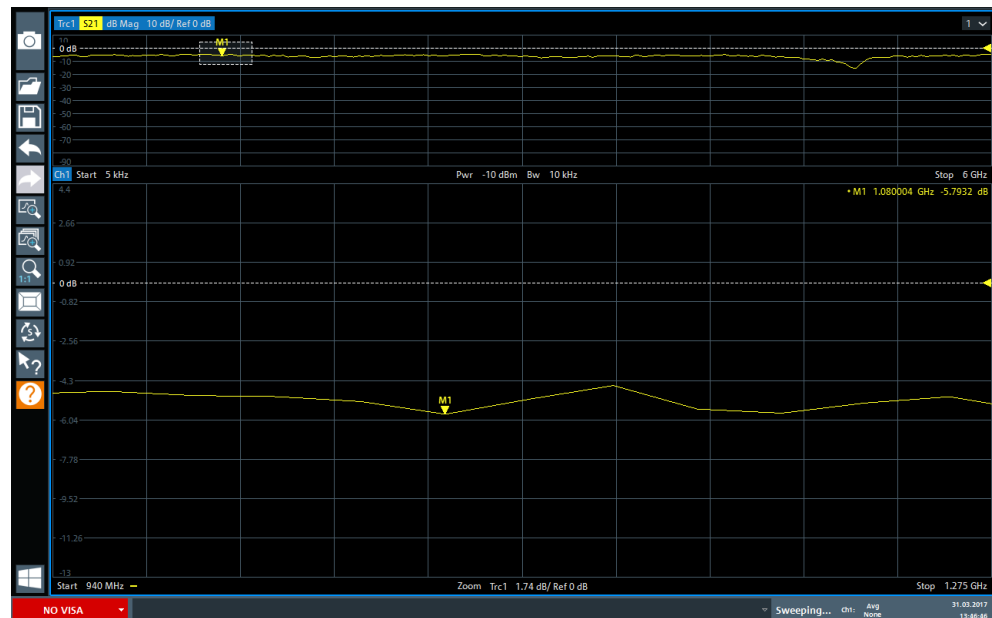

Figure 4-6: Zoomed display around a peak

4.3.3 Saving Settings

To restore the results of our measurements later, we will store the instrument settings to a file.

To save the instrument settings to a file



1. Tap the "Save" icon in the toolbar.



2. Press the keyboard key on the front panel to display the online keyboard, as you will have to enter text in the next step.

- In the "Save" dialog box, tap the "File name" field and enter *MyMultiViewSetup* using the keyboard.
Keep the default "File Type" setting "Instrument with all Channel Setups" to store the configuration of all channel setups.

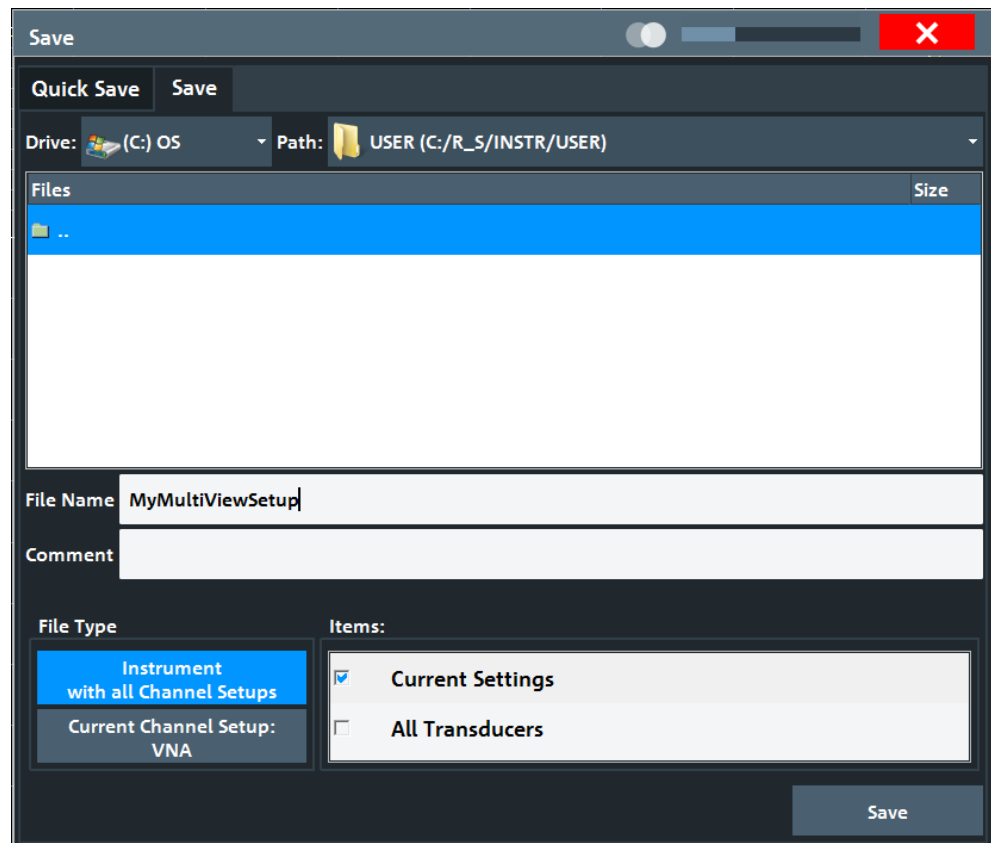

Figure 4-7: Saving the instrument settings to a file

- Tap the "Save" button.

The file *MyMultiViewSetup.dfl* is stored in the default directory
 C:\ProgramData\Rohde-Schwarz\ZNL-FPL\Save.

To load stored instrument settings

You can restore the settings to the instrument at any time using the settings file.

- Press the [Preset] button to restore the default instrument settings so you can check that the stored user settings are actually restored afterwards.



- Tap the "Load" icon in the toolbar.
- In the "Load" dialog box, select the *MyMultiViewSetup.dfl* file in the default directory C:\ProgramData\Rohde-Schwarz\ZNL-FPL\Save.

4. Tap the "Load" button.

All instrument settings are restored and the display should resemble the instrument display right before the settings were stored.

4.3.4 Printing and Saving Results

Finally, after a successful measurement, we will document our results. First we will export the numeric trace data, then we will create a screenshot of the graphical display.

To export the trace data

1. Press the [Trace] key on the front panel.
2. Tap the Trace softkey.
3. Tap the "Trace / Data Export" tab.
4. Tap the "Export Trace to ASCII File" button.
5. Enter the file name *MyMultiViewResults*.

The trace data is stored to `MyMultiViewResults.DAT`

To create a screenshot of the display



1. Tap the "Print immediately" icon in the toolbar.

A screenshot of the current display is created. Note that the colors on the screen are inverted in the screenshot to improve printout results.

2. In the "Save Hardcopy as " > "Portable Network Graphics (PNG)" dialog box, enter a file name, e.g. *MyMultiViewDisplay*.

The screenshot is stored to `MyMultiViewDisplay.png`.

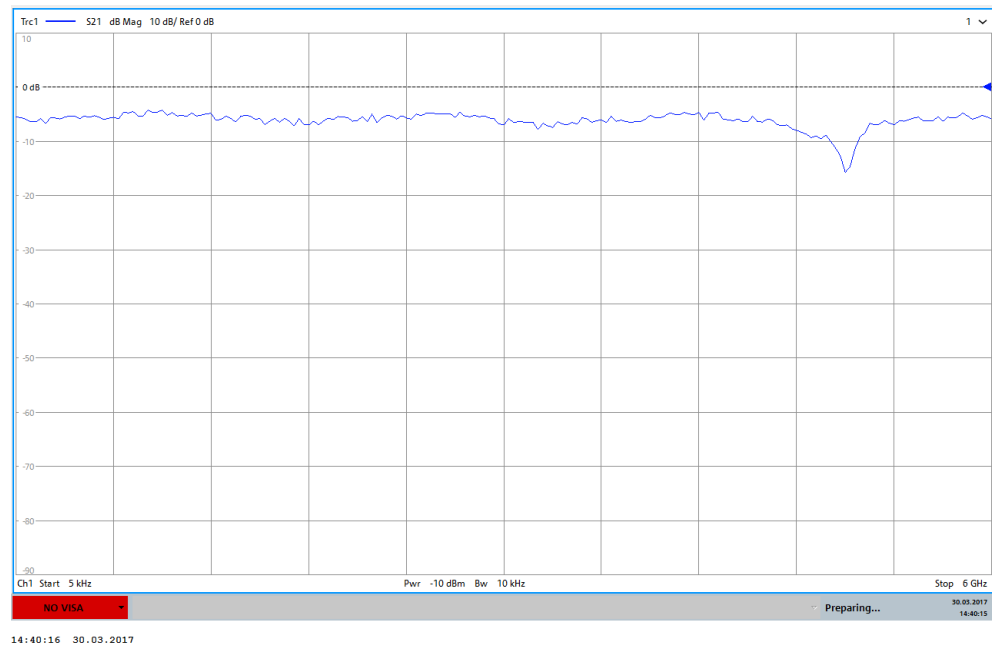

4.3.5 Activating Additional Channel Setups

The R&S ZNL/ZNLE features multiple channel setups, i.e. you can define several measurement configurations in parallel and then switch between the channel setups automatically to perform the measurements sequentially. We will demonstrate this feature by activating additional channel setups for a different frequency range, a Spectrum measurement, and an I/Q analysis (note that the latter two measurements are only available if the optional Spectrum mode is installed).

To activate additional channel setups

1. Press the [Mode] key on the front panel.
2. On the "New Channel Setup" tab of the "Mode" dialog box, tap the "VNA" button.
3. Change the frequency range for this measurement:
Set the **center frequency** to *500 MHz* and the **span** to *1 GHz*.
4. Press the [Mode] key on the front panel.
5. On the "New Channel Setup" tab of the "Mode" dialog box, tap the "Spectrum" button.

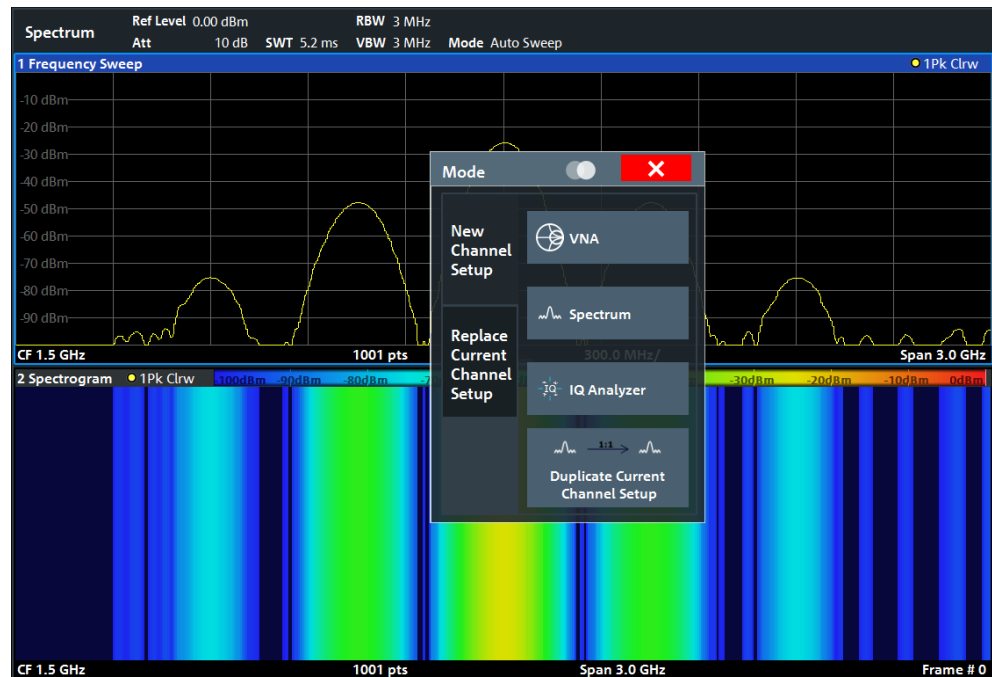

Figure 4-8: Adding a new channel setup

6. Create a new channel setup for I/Q analysis:
 - a) Press the [Mode] key.
 - b) Tap the "IQ Analyzer" button to activate a channel setup for the I/Q Analyzer application.
 - c) Tap the "Display Config" softkey to activate the SmartGrid mode.
 - d) Drag the "Real/Imag (I/Q)" icon from the evaluation bar to the SmartGrid.

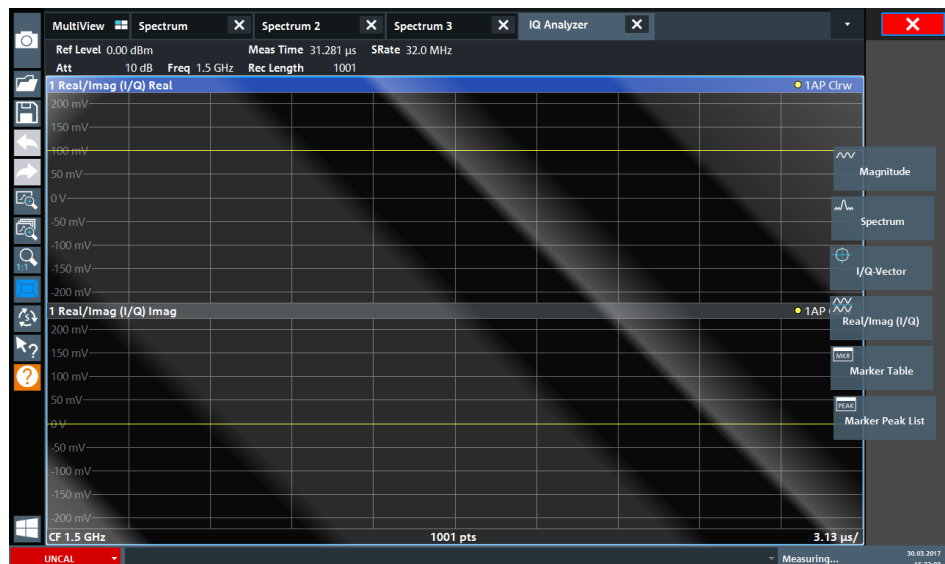

Figure 4-9: Inserting a Real/Imag diagram for I/Q analysis

- e) Close the SmartGrid mode.

The "IQ Analyzer" channel setup displays the real and imaginary signal parts in separate windows.

To display the MultiView tab

An overview of all active channel setups is provided in the "MultiView" tab. This tab is always displayed if more than one channel setup is active and cannot be closed.

- Tap the "MultiView" tab.

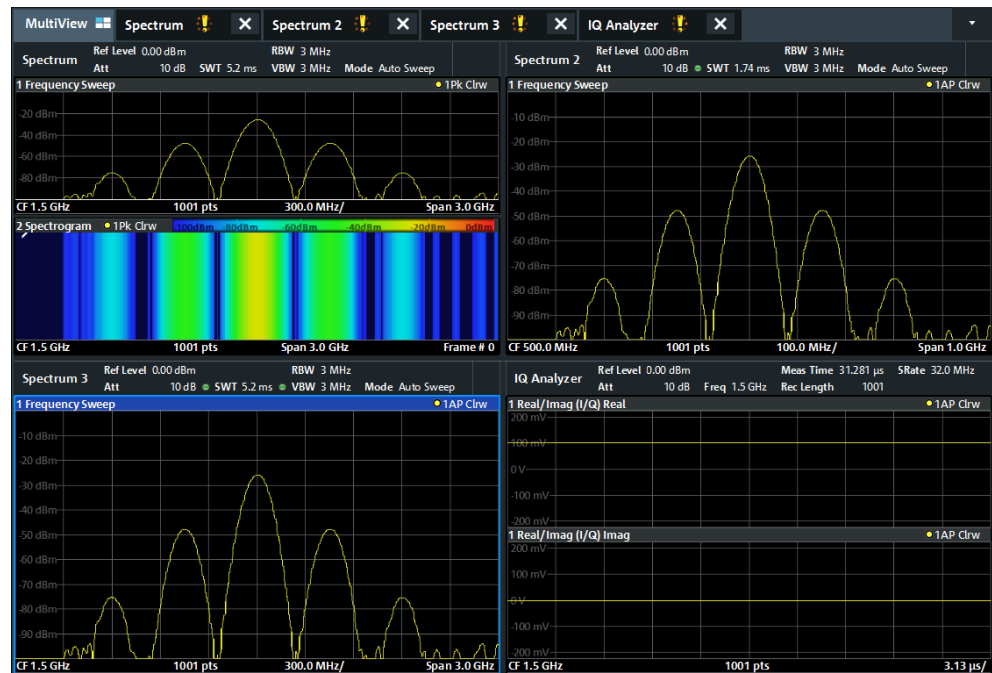

Figure 4-10: The "MultiView" tab

4.3.6 Trying Out Spectrum Mode

If the spectrum analysis option B1 for the R&S ZNL is installed, you can use the instrument for Spectrum measurements. The following chapters describe some basic tasks in spectrum mode.



For the current R&S ZNL14 and R&S ZNL20 models (order nos. 1323.0012.14 and 1323.0012.20), a B1 option and all other dependent options **are not available** and **will not be available** in future.

Successor models, which will support the B1 option and all other dependent options will be available at a later stage.

A spectrum analysis option for the R&S ZNLE is not available.

- [Measuring a Basic Signal](#).....66
- [Displaying a Spectrogram](#).....68
- [Setting and Moving a Marker](#).....70
- [Displaying a Marker Peak List](#).....71

4.3.6.1 Measuring a Basic Signal

We will start out by measuring a simple sinus wave, using the internal calibration signal as the input.

To display the internal 50 MHz calibration signal

1. Press the [Preset] key to start out in a defined instrument configuration.
2. Press
3. Press the [Setup] key.
4. Tap the "Service + Support" softkey.
5. Tap the "Calibration Signal" tab.
6. Tap the "Calibration Frequency RF" option. Leave the frequency at the default 50 MHz.
7. Close the dialog box.

The calibration signal is now sent to the RF input of the R&S ZNL/ZNLE. By default, a continuous frequency sweep is performed, so that the spectrum of the calibration signal is now displayed in the standard level versus frequency diagram.

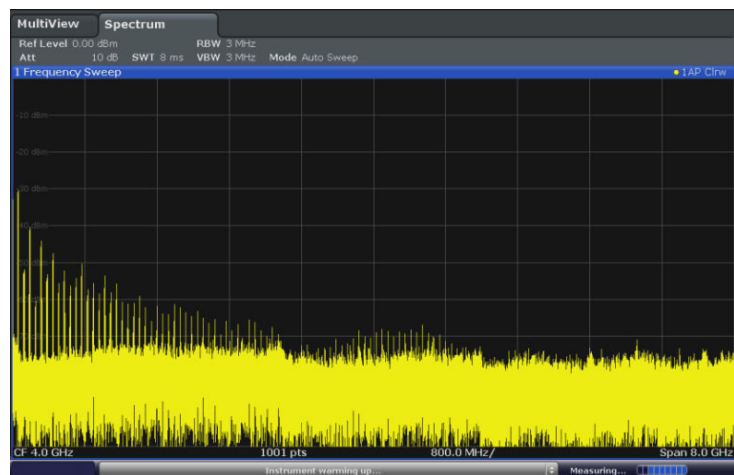

Figure 4-11: Calibration signal as RF input



Instrument warmup time

Note that the instrument requires an initial warmup time after switching it on. A message in the status bar ("Instrument warming up...") indicates that the operating temperature has not yet been reached. Wait until this message is no longer displayed before you start a measurement.

To optimize the display

To optimize the display for the calibration signal, we will adjust the main measurement settings.

1. Set the center frequency to the calibration frequency:
 - a) Tap the "Overview" softkey to display the configuration "Overview".
 - b) Tap the "Frequency" button.
 - c) In the "Center" field, enter *50* on the number pad on the front panel.
 - d) Press the "MHz" key next to the number pad.
2. Reduce the span to 20 MHz:
 - a) In the "Span" field of the "Frequency" dialog box, enter *20 MHz*.
 - b) Close the "Frequency" dialog box.
3. Set the reference level to -25 dBm:
 - a) In the configuration "Overview", tap the "Amplitude" button.
 - b) In the "Value" field of the "Amplitude" dialog box, enter *-25 dBm*.

The display of the calibration signal is now improved. The maximum at the center frequency (=calibration frequency) of 50 MHz becomes visible.

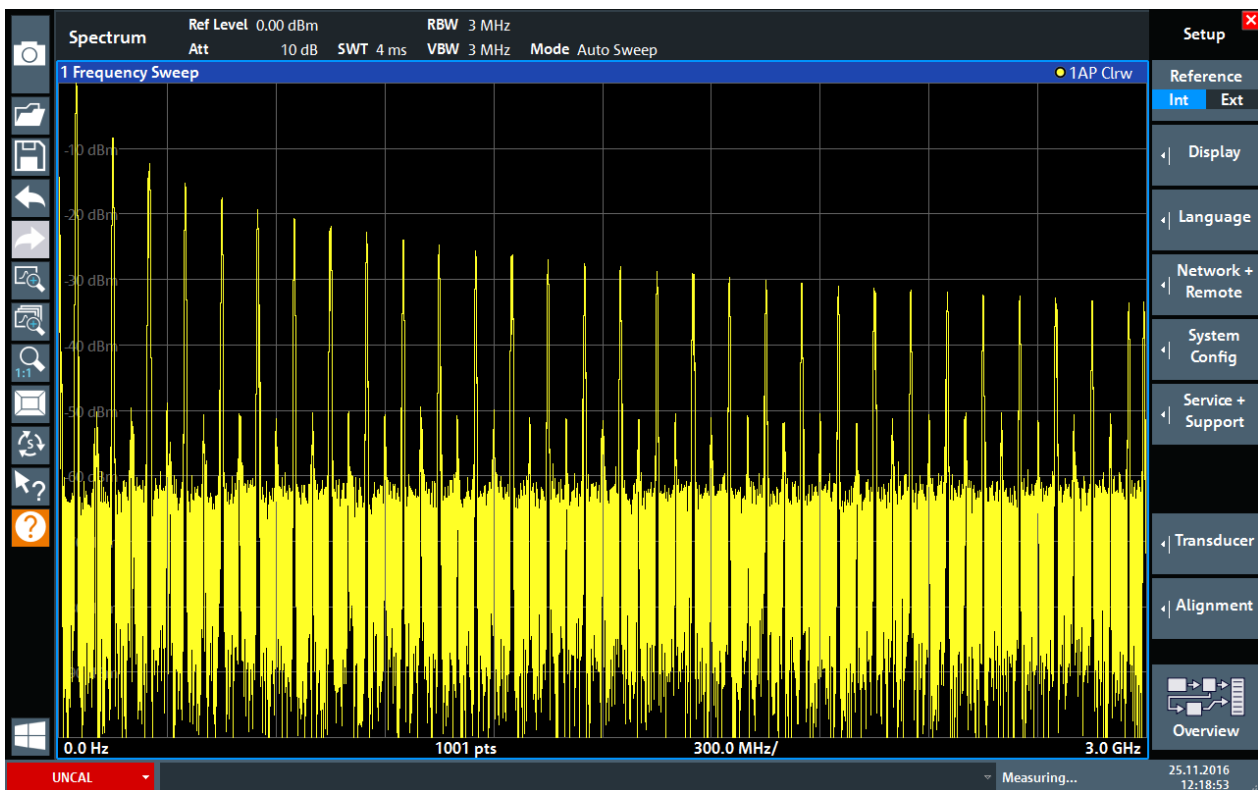



Figure 4-12: Calibration signal with optimized display settings

4.3.6.2 Displaying a Spectrogram

In addition to the standard "level versus frequency" spectrum display, the R&S ZNL/ZNLE also provides a spectrogram display of the measured data. A spectrogram shows how the spectral density of a signal varies over time. The x-axis shows the frequency, the y-axis shows the time. A third dimension, the power level, is indicated by different colors. Thus you can see how the strength of the signal varies over time for different frequencies.

1. Tap the "Overview" softkey to display the general configuration dialog box.
2. Tap the "Display Config" button.

The SmartGrid mode is activated, and the evaluation bar with the available evaluation methods is displayed.

3.  Spectrogram

Drag the "Spectrogram" icon from the evaluation bar to the diagram area. The blue area indicates that the new diagram would replace the previous spectrum display. Since we do not want to replace the spectrum, drag the icon to the lower half of the display to add a window instead.

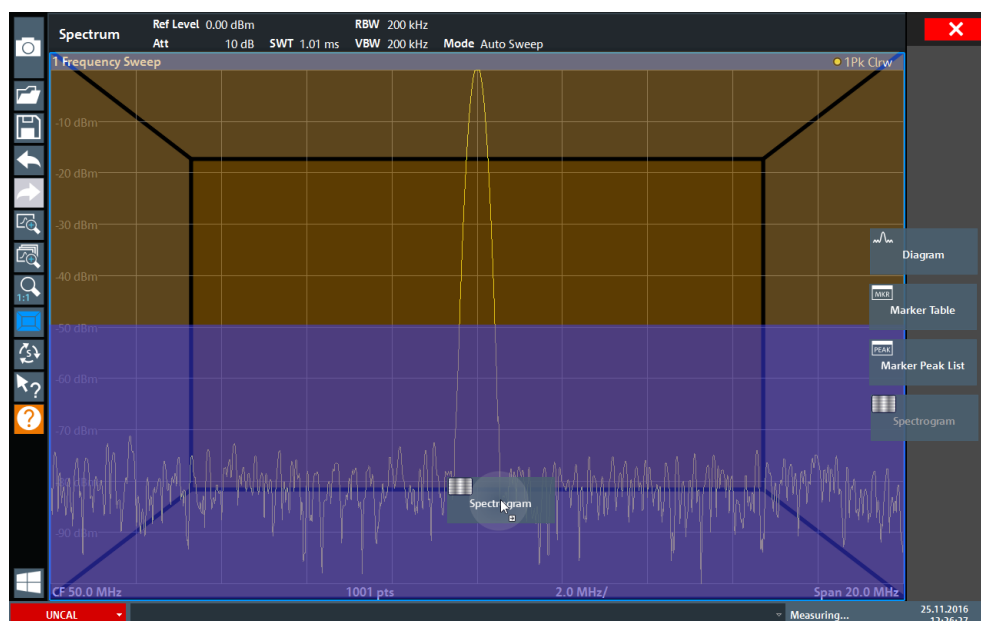

Figure 4-13: Adding a Spectrogram to the display

Drop the icon.

4. Close the SmartGrid mode by tapping the "Close" icon at the top right corner of the toolbar.



You see the spectrogram compared to the standard spectrum display. Since the calibration signal does not change over time, the color of the frequency levels does not change over time, i.e. vertically. The legend at the top of the spectrogram window describes the power levels the colors represent.

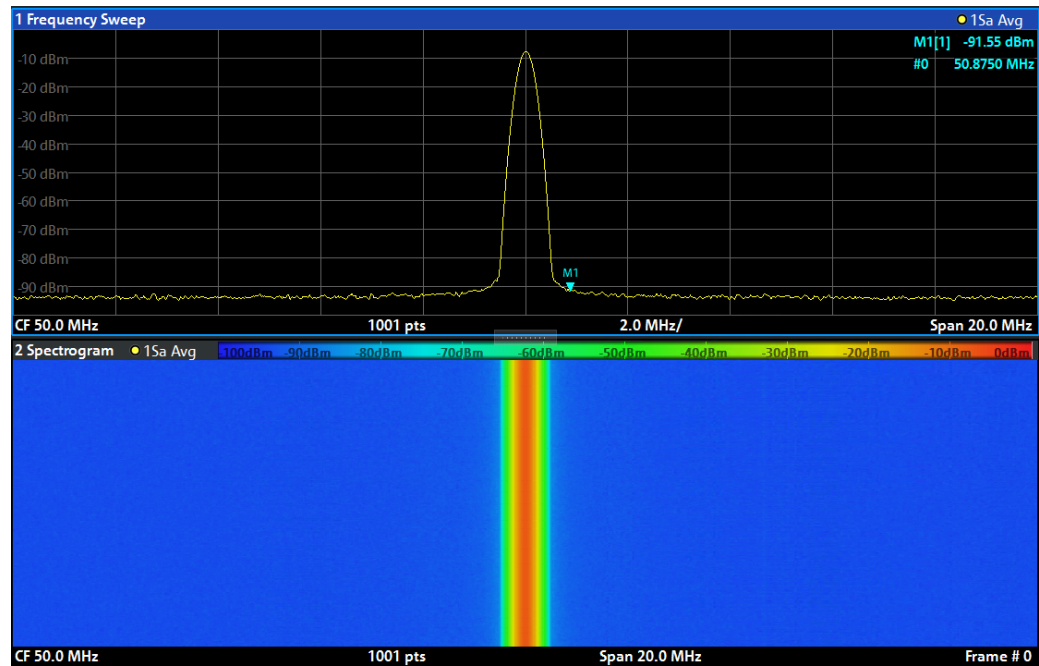

Figure 4-14: Spectrogram of the calibration signal

4.3.6.3 Setting and Moving a Marker

Markers are useful to determine the position of particular effects in the trace. The most common use is to determine a peak, which is the default setting when you activate a marker. We will set a marker on the peak in our first Spectrum measurement.

1. In the "MultiView" tab, double-tap the "Spectrum" window (frequency sweep with spectrogram display) to return to the "Spectrum" channel setup.
2. Tap the spectrum display to set the focus on that window.
3. Double-tap the spectrum window to maximize it, as we currently do not need the spectrogram display.
4. Press the "RUN SINGLE" key on the front panel to perform a single sweep so we have a fixed trace to set a marker on.
5. Press the [MKR] key on the front panel to display the "Marker" menu.

Marker 1 is activated and automatically set to the maximum of trace 1. The marker position and value is indicated in the diagram area as M1[1].

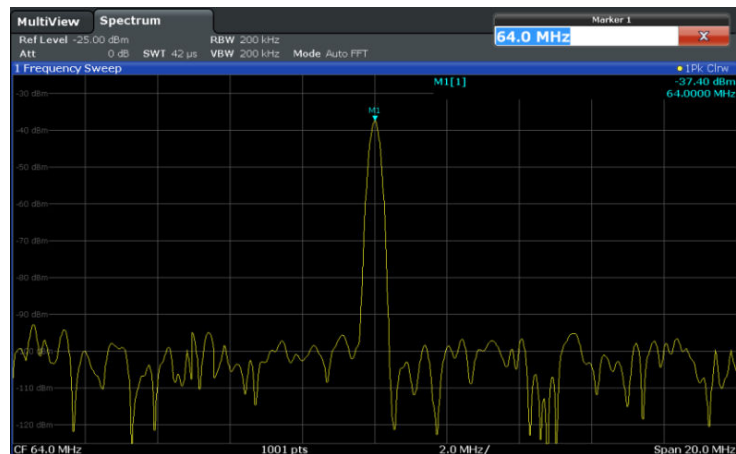

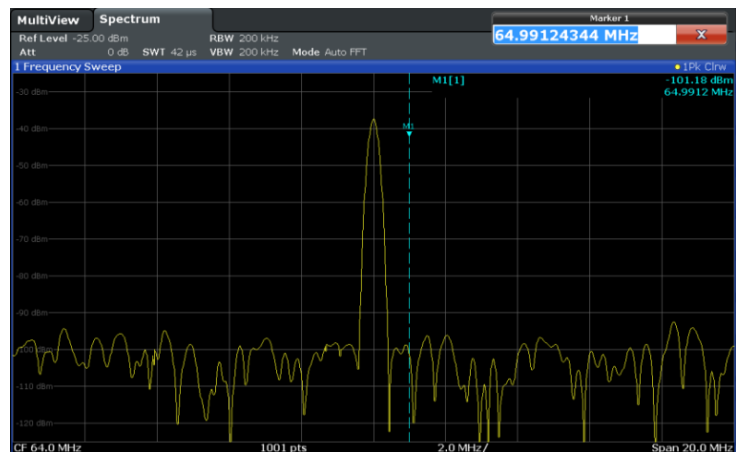

- Now you can move the marker by tapping and dragging it to a different position. The current position is indicated by a dotted blue line. Notice how the position and value change in the marker area of the diagram.



4.3.6.4 Displaying a Marker Peak List

The marker peak list determines the frequencies and levels of peaks in the spectrum automatically. We will display a marker peak list for the Spectrum 2 channel setup.

- Tap the "Spectrum 2" tab.
- Press the "RUN SINGLE" key on the front panel to perform a single sweep for which we will determine the peaks.
-  Tap the "SmartGrid" icon in the toolbar to activate SmartGrid mode.
-  Drag the "Marker Peak List" icon from the evaluation bar to the lower half of the display to add a new window for the peak list.
- Close the SmartGrid mode.

6. To obtain a more conclusive peak list that does not contain noise peaks, for example, define a threshold that is higher than the noise floor:
 - a) Press the [MKR] key on the front panel.
 - b) Tap the "Marker Config" softkey in the "Marker" menu.
 - c) Tap the "Search" tab in the "Marker" dialog box.
 - d) In the "Threshold" field, enter -68 dBm.
 - e) Tap the "State" box for "Threshold" to activate its use.
Only peaks that are larger than -68 dBm will be included in the peak list.

The marker peak list displays the determined peaks that are above the defined threshold.

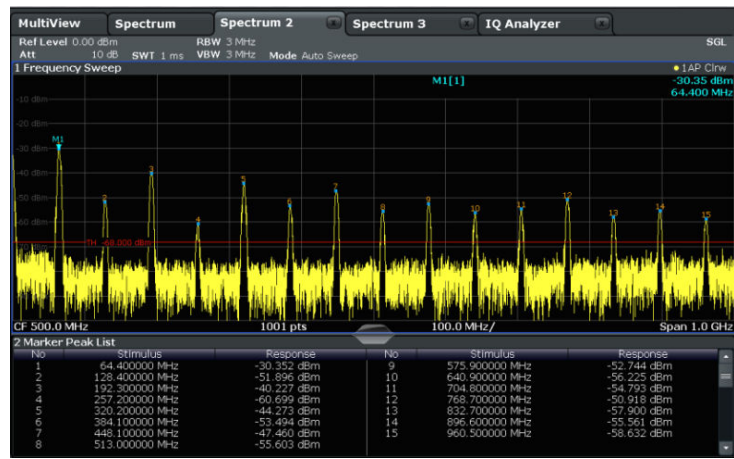

Figure 4-15: Marker Peak List

4.3.7 Performing Sequential Measurements

Although only one measurement can be performed at any one time, the measurements configured in the active channel setups can be performed sequentially, that means: one after the other, automatically, either once or continuously.



1. Tap the "Sequencer" icon in the toolbar.
2. Toggle the "Sequencer" softkey in the "Sequencer" menu to "On".

A continuous sequence is started, i.e. each channel setup measurement is performed one after the other until the Sequencer is stopped.

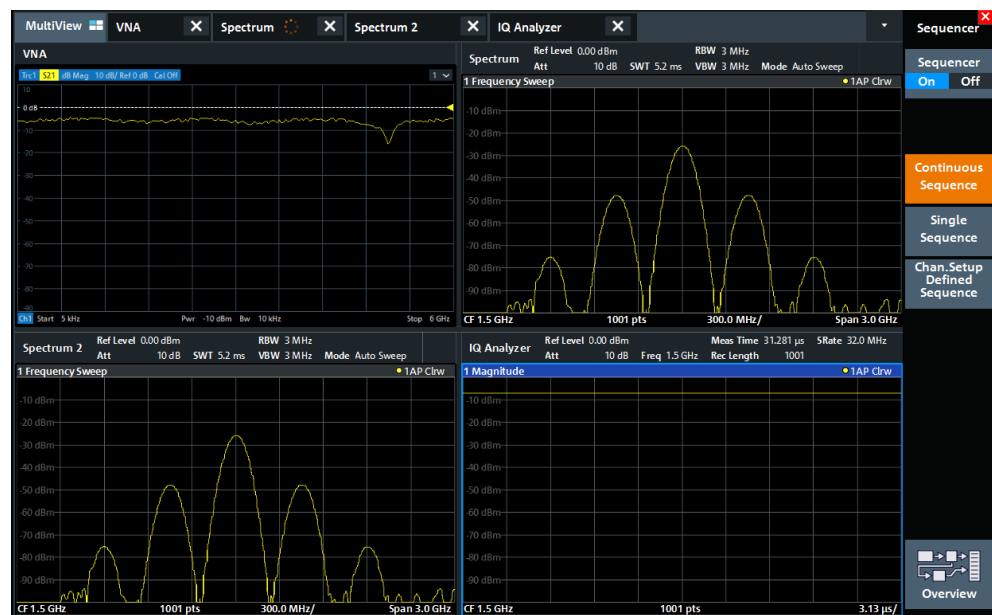

Figure 4-16: "MultiView" tab with active Sequencer



In Figure 4-16, the "Spectrum 2" measurement is currently active (indicated by the "channel active" icon in the tab label).

3. Stop the Sequencer by tapping the "Sequencer" softkey again.

4.4 Operating the Instrument

This chapter provides an overview on how to work with the R&S ZNL/ZNLE.



Remote control

In addition to working with the R&S ZNL/ZNLE interactively, located directly at the instrument, it is also possible to operate and control it from a remote PC. Various methods for remote control are supported:

- Connecting the instrument to a (LAN) network
- Using the web browser interface in a LAN network
- Using the Windows Remote Desktop application in a LAN network
- Connecting a PC via the GPIB interface

How to configure the remote control interfaces is described in the R&S ZNL/ZNLE user manual.

- [Understanding the Display Information \(VNA Mode\)](#)..... 74
- [Accessing the Functionality](#).....75
- [Entering Data](#)..... 80
- [Touchscreen Gestures](#)..... 81
- [Getting Help](#)..... 84

4.4.1 Understanding the Display Information (VNA Mode)

The following figure shows a measurement diagram in VNA mode. All different information areas are labeled. They are explained in more detail in the following sections.

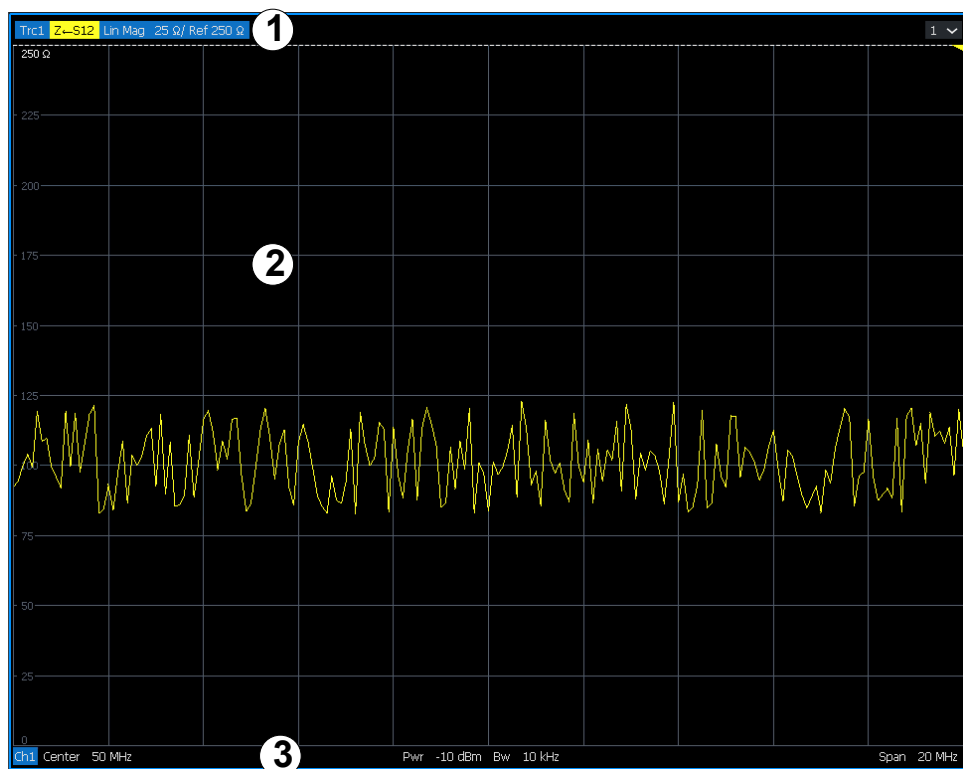

1 = Window title bar with measurement-specific (trace) information

2 = Diagram area with marker information

3 = Diagram footer with diagram-specific information

Window title bar

For each parameter diagram, a window is displayed with the following information in the title bar:



- 1 = Trace name
- 2 = Measured parameter
- 3 = Trace format
- 4 = Scale per division
- 5 = Reference value

Diagram footer

For each parameter diagram, a window is displayed with the following information in the footer:

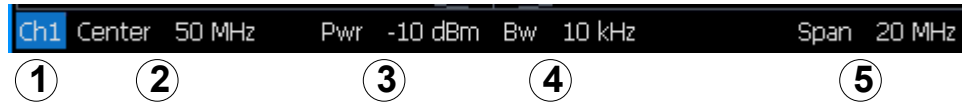

- 1 = Channel
- 2 = Center frequency
- 3 = Power level
- 4 = Measurement bandwidth
- 5 = Span

4.4.2 Accessing the Functionality

All tasks necessary to operate the instrument can be performed using this user interface. Apart from instrument specific keys, all other keys that correspond to an external keyboard (e.g. arrow keys, ENTER key) operate as specified by Microsoft.

For most tasks, there are at least 2 alternative methods to perform them:

- Using the touchscreen
- Using other elements provided by the front panel, e.g. the keypad, rotary knob, or arrow and position keys.

The measurement and instrument functions and settings can be accessed by selecting one of the following elements:

- System and function keys on the front panel of the instrument
- Softkeys on the touchscreen
- Context menus for specific elements on the touchscreen
- Icons on the tool bar in the touchscreen
- Displayed setting on the touchscreen

4.4.2.1 Toolbar Functions

Standard functions can be performed via the icons in the toolbar at the top of the screen.



You can hide the toolbar display, e.g. when using remote control, to enlarge the display area for the measurement results ("Setup" > "Display" > "Displayed Items").

See [Chapter 7.2.1.2, "Displayed Items"](#), on page 122.

Print immediately.....	76
Open.....	76
Save.....	76
Undo.....	76
Redo.....	77
Zoom mode.....	77
Multiple zoom mode.....	77
Zoom off.....	77
SmartGrid.....	77
Sequencer.....	77
Gen On/Off.....	77
Gen Config.....	77
Help (+ Select).....	77
Help.....	77
Windows.....	77



Print immediately

Prints the current display (screenshot) as configured.

See [Chapter 6.3, "Creating Screenshots of Current Measurement Results and Settings"](#), on page 106.



Open

Opens a file from the instrument ("Save/Recall" menu).

See [Chapter 6.2, "Storing and Recalling Instrument Settings and Measurement Data"](#), on page 96.



Save

Stores data on the instrument ("Save/Recall" menu).

See [Chapter 6.2, "Storing and Recalling Instrument Settings and Measurement Data"](#), on page 96.



Undo

Reverts last operation, i.e. the status before the previous action is retrieved.

The undo function is useful, for example, if you are performing a zero span measurement with several markers and a limit line defined and accidentally select a different measurement. In this case, many settings would be lost. However, if you press [UNDO] immediately afterwards, the previous status is retrieved, i.e. the zero span measurement and all settings.

Note: The [UNDO] function is not available after a [PRESET] or "Recall" operation. When these functions are used, the history of previous actions is deleted.



Redo

Repeats previously reverted operation



Zoom mode

Displays a dotted rectangle in the diagram that can be expanded to define the zoom area.



Multiple zoom mode

Multiple zoom areas can be defined for the same diagram.



Zoom off

Displays the diagram in its original size.



SmartGrid

Activates "SmartGrid" mode to configure the screen layout.

For Spectrum mode only, see the R&S ZNL/ZNLE Spectrum Mode user manual.



Sequencer

Opens the "Sequencer" menu to perform consecutive measurements.

See [Chapter 5.4, "Running a Sequence of Measurements"](#), on page 90



Gen On/Off

Enables/disables the independent CW source. Requires the option R&S ZNL/ZNLE-K14.



Gen Config

Opens the dialog box to configure the independent CW source. Requires the option R&S ZNL/ZNLE-K14.



Help (+ Select)

Allows you to select an object for which context-specific help is displayed

See [Chapter 4.4.5, "Getting Help"](#), on page 84



Help

Displays context-sensitive help topic for the most recently selected element

See [Chapter 4.4.5, "Getting Help"](#), on page 84



Windows

Displays the Windows "Start" menu and task bar.

See ["To access the "Start" menu"](#) on page 36.

4.4.2.2 Softtools

Softtools display groups of related settings as a tabbed panel. They can be opened via function keys on the (virtual) front panel, or via context menu items.

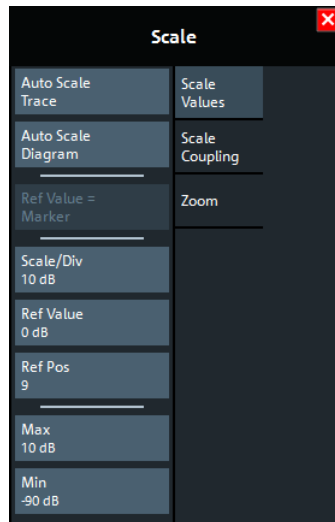

Figure 4-17: Scale softtool

The softtools are displayed in the softkey bar of the instrument. The title area of the softkey bar displays the name of the currently opened softtool.



If you close the softkey bar using its close icon, it is automatically reopened the next time a function key is pressed. You can change this behavior in the "User Interface" tab of the "VNA Setup" dialog.

See "[Pressing Hardkey Reactivates Softkey Bar](#)" on page 144.

Some controls on the softtool tabs allow you to read and modify settings (e.g. "Ref Value" in the screenshot above), some perform actions (e.g. "Auto Scale Trace"), while others open additional dialogs (button label ends with "...").

4.4.2.3 Context Menus

Several items in the diagram area have context menus (for example markers, traces or the channel bar). If you right-click on one of these items (or tap it for about 1 second), a menu is displayed which contains the same functions as the corresponding softkey. This is useful, for example, when the softkey display is hidden.

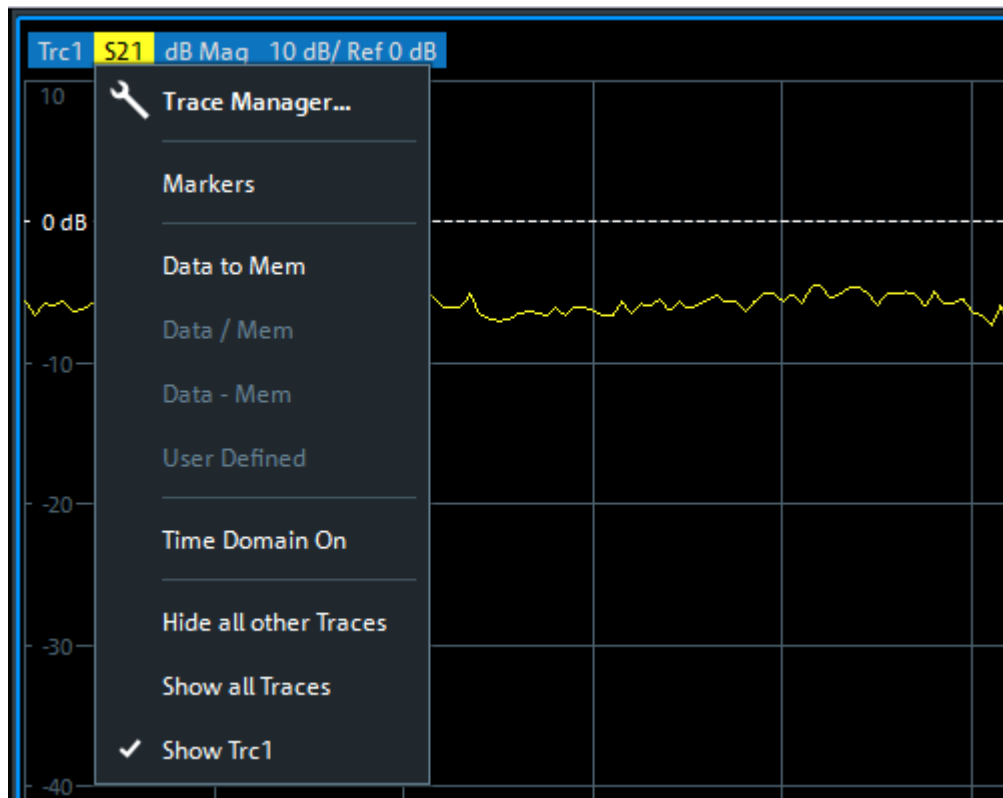

4.4.2.4 On-screen Keyboard

The on-screen keyboard is an additional means of interacting with the instrument without having to connect an external keyboard.

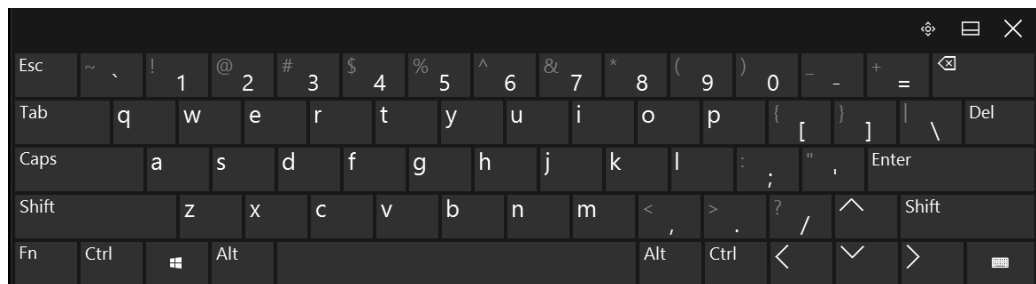

The on-screen keyboard display can be switched on and off as desired using the "On-Screen Keyboard" function key beneath the screen.



When you press this key, the display switches between the following options:

- Keyboard displayed at the top of the screen
- Keyboard displayed at the bottom of the screen
- No keyboard displayed



You can use the TAB key on the on-screen keyboard to move the focus from one field to another in dialog boxes.

4.4.3 Entering Data

Data can be entered in dialog boxes using one of the following methods:

- Using the touchscreen, via the online keyboard
- Using other elements provided by the front panel, e.g. the keypad, rotary knob, or navigation keys
The rotary knob acts like the [ENTER] key when it is pressed.
- Using a connected external keyboard



Transparent dialog boxes

You can change the transparency of the dialog boxes to see the results in the windows behind the dialog box. Thus, you can see the effects that the changes you make to the settings have on the results immediately.

To change the transparency, select the transparency icon at the top of the dialog box. A slider is displayed. To hide the slider, select the transparency icon again.



(The title bar of the dialog box is always slightly transparent and is not affected by the slider.)



Particularities in Windows dialog boxes

In some cases, e.g. if you want to install a printer, original Windows dialog boxes are used. In these dialog boxes, the rotary knob and function keys do not work. Use the touchscreen instead.

Entering Numeric Parameters

If a field requires numeric input, the keypad provides only numbers.

1. Enter the parameter value using the keypad, or change the currently used parameter value by using the rotary knob (small steps) or the [UP] or [DOWN] keys (large steps).
2. After entering the numeric value via keypad, press the corresponding unit key. The unit is added to the entry.
3. If the parameter does not require a unit, confirm the entered value by pressing the [ENTER] key or any of the unit keys. The editing line is highlighted to confirm the entry.

Entering Alphanumeric Parameters

If a field requires alphanumeric input, you can use the on-screen keyboard to enter numbers and (special) characters (see [Chapter 4.4.2.4, "On-screen Keyboard"](#), on page 79).

Correcting an entry

1. Using the arrow keys, move the cursor to the right of the entry you want to delete.
2. Press the [Backspace] key.
The entry to the left of the cursor is deleted.
3. Enter your correction.

Completing the entry

- ▶ Press the [ENTER] key or the rotary knob.

Aborting the entry

- ▶ Press the [ESC] key.
The dialog box is closed without changing the settings.

4.4.4 Touchscreen Gestures

A touchscreen allows you to interact with the software using various finger gestures on the screen. The basic gestures supported by the software and most applications are described here. Further actions using the same gestures may be possible.



Tapping

Touch the screen quickly, usually on a specific element.

You can tap most elements on the screen; in particular, any elements you can also click on with a mouse pointer.

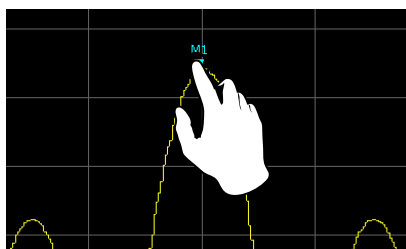
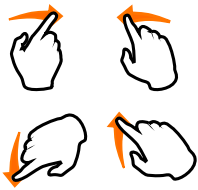

Figure 4-18: Tapping

Double-tapping

Tap the screen twice, in quick succession.

Double-tap a diagram or the window title bar to maximize a window in the display, or to restore the original size.



Dragging

Move your finger from one position to another on the display, keeping your finger on the display the whole time.

By dragging your finger over a table or diagram you can pan the displayed area of the table or diagram to show results that were previously out of view.

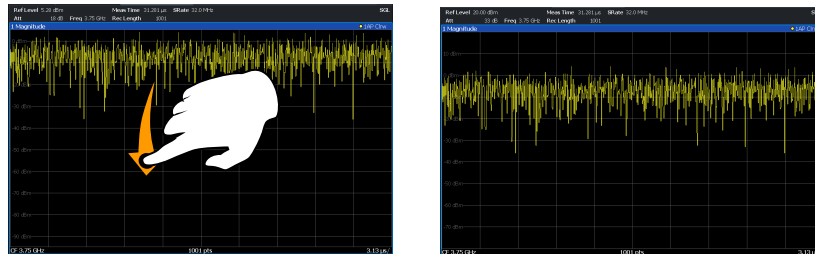
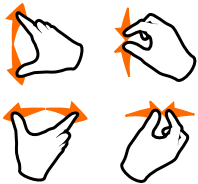

Figure 4-19: Dragging



Pinching and spreading two fingers

Move two fingers together on the display (pinch) or move two fingers apart on the display (spread).

When you pinch two fingers in the display, you decrease the size of the currently displayed area, showing the surrounding areas previously out of view.

When you spread two fingers in the display, you increase the size of the currently displayed area, showing more details.

You can pinch or spread your fingers vertically, horizontally, or diagonally. The direction in which you move your fingers determines which dimension of the display is changed.

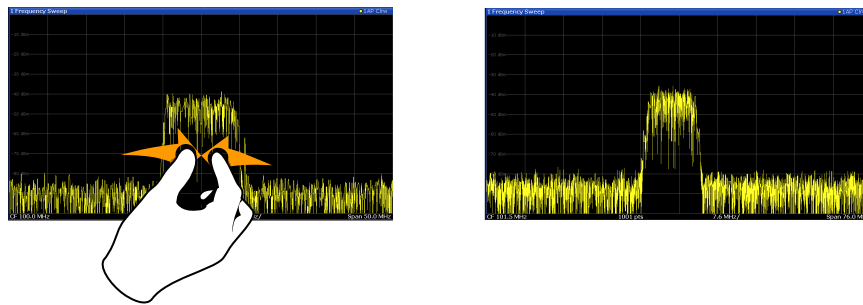

Figure 4-20: Pinching

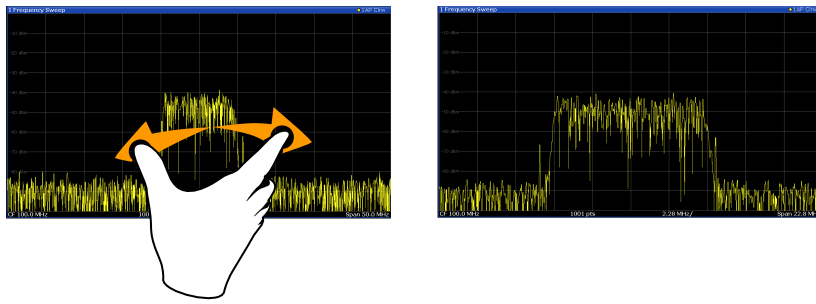

Figure 4-21: Spreading



Touch gestures in diagrams change measurement settings

When you change the display using touch gestures, the corresponding measurement settings are adapted. This is different to selecting an area on the screen in zoom mode, where merely the resolution of the displayed trace points is changed temporarily (graphical zoom).

Mouse vs. touch actions

Any user interface elements that react to actions by a mouse pointer also react to finger gestures on the screen, and vice versa. The following touch actions correspond to mouse actions:

Table 4-5: Correlation of mouse and touch actions

Mouse operation	Touch operation
Click	Tap
Double-click	Double-tap
Click and hold	Touch and hold
Right-click	Touch, hold for 1 second and release
Drag-&-drop (= click and hold, then drag and release)	Touch, then drag and release
n.a. (Change hardware settings)	Spread and pinch two fingers
Mouse wheel to scroll up or down	Swipe
Dragging scrollbars to scroll up or down, left or right	Swipe
In (graphical) Zoom mode only: dragging the borders of the displayed rectangle to change its size	Touch, then drag and release

Example:

You can scroll through a long table in conventional mouse operation by clicking in the table's scrollbar repeatedly. In touch operation, you would scroll through the table by dragging the table up and down with your finger.

4.4.5 Getting Help

If any questions or problems concerning the R&S ZNL/ZNLE arise, an extensive online help system is provided on the instrument and can be consulted at any time. The help system is context-sensitive and provides information specifically for the current operation or setting to be performed. In addition, general topics provide an overview on complete tasks or function groups as well as background information.

The online help can be opened at any time by selecting one of the "Help" icons on the toolbar or by pressing the [F1] key on an external or the on-screen keyboard.

To call context-sensitive help

- ▶ To display the "Help" dialog box for the currently focused screen element, e.g. a softkey or a setting in an opened dialog box, select the "Help" icon on the toolbar.



The "Help" dialog box "View" tab is displayed. A topic containing information about the focused screen element is displayed.

If no context-specific help topic is available, a more general topic or the "Content" tab is displayed.



For standard Windows dialog boxes (e.g. File Properties, Print dialog etc.), no context-sensitive help is available.

To display a help topic for a screen element not currently focused

1. Select the "Help pointer" icon on the toolbar.



The pointer changes its shape to a "?" and an arrow.

2. Select the screen element to change the focus.

A topic containing information about the selected (now focused) screen element is displayed.

5 Operating Modes, Applications, Channel Setups, and Result Displays

If the "Spectrum Analysis" hardware option B1 is installed, the R&S ZNL is actually two instruments in one: a vector network analyzer (VNA) and a spectrum analyzer (SA). The R&S ZNL integrates the functionality of the two as separate operating modes in one instrument. The advantage is that you can perform typical network analyzer tasks on a dedicated network analyzer, and spectrum analyzer tasks on a dedicated spectrum analyzer, without having to buy, maintain, and set up two individual instruments. Furthermore, you can easily and quickly switch between measurement tasks in different operating modes, and hardly notice the difference in operation. Both are just different applications on the same instrument. Internally, however, the data is processed using entirely separate hardware, always optimized to the selected operating mode.



- A spectrum analysis option for the R&S ZNLE is not available.
- For the current R&S ZNL14 and R&S ZNL20 models (order nos. 1323.0012.14 and 1323.0012.20), a B1 option and all other dependent options **are not available** and **will not be available** in future.
Successor models, which will support the B1 option and all other dependent options will be available at a later stage.
- Note that interruptions in analog output may occur if you switch between a VNA and a spectrum application, due to the separate hardware. In particular, if you run a sequence of measurements including both measurement types, switching between both modes can interrupt the signal from the output connector.

The Spectrum operating mode allows you to perform all sorts of different analysis tasks on different types of signals, e.g. Analog Demodulation, I/Q analysis or basic spectrum analysis. Depending on the task or type of signal, a different set of measurement functions and parameters are required. Therefore, the Spectrum operating mode provides various applications - some of which are included in the base unit, others are optional.

The default application when you start the R&S ZNL/ZNLE is "VNA", for basic network analysis.

Channel Setups

When you activate an application, a new channel setup is created which determines the measurement settings for that application. The same application can be activated with different measurement settings by creating several channel setups for the same application.

The number of channel setups that can be configured at the same time depends on the available memory on the instrument.

For more information on creating channel setups, see [Chapter 5.3, "Defining Channel Setups"](#), on page 88.

• Available Applications.....	86
• R&S MultiView.....	87
• Defining Channel Setups.....	88
• Running a Sequence of Measurements.....	90

5.1 Available Applications

Access: [Mode]

Without the spectrum analysis hardware option B1, the R&S ZNL only provides the [VNA](#) application.

- The "Spectrum analysis" hardware option adds the [Spectrum](#) and [I/Q Analyzer](#) applications.
- The "Analog Demodulation" software option software option R&S FPL1-K7 adds the [Analog Demod](#) application.
- The "Noise Figure" software option software option R&S FPL1-K30 adds the [Noise Figure](#) application.

Each application is described in a separate manual.



For the R&S ZNLE and the current R&S ZNL14 and R&S ZNL20 models (order nos.1323.0012.14 and 1323.0012.20) these options are not available and hence there is only the [VNA](#) application.

VNA	86
Spectrum	86
I/Q Analyzer	87
Analog Demod	87
Noise Figure	87

VNA

In the VNA application the provided functions correspond to those of a conventional vector network analyzer.

Remote command:

INST:SEL VNA, see [INSTrument\[:SElect\]](#) on page 529

Spectrum

In the "Spectrum" application the provided functions correspond to those of a conventional spectrum analyzer. The analyzer measures the frequency spectrum of the RF input signal over the selected frequency range with the selected resolution and sweep time. Alternatively, it displays the waveform of the video signal for a fixed frequency.

The "Spectrum" application requires a R&S ZNL equipped with the "Spectrum Analysis" hardware option B1.

Note: For the R&S ZNLE and the current R&S ZNL14 and R&S ZNL20 models (order nos.1323.0012.14 and 1323.0012.20) a "Spectrum Analysis" hardware option is not available.

The "Spectrum" application is described in the R&S ZNL Spectrum Analyzer Mode User Manual.

Remote command:

INST:SEL SAN, see [INSTrument\[:SElect\]](#) on page 529

I/Q Analyzer

The I/Q Analyzer application provides measurement and display functions for I/Q data.

The "I/Q Analyzer" application requires a R&S ZNL equipped with the "Spectrum Analysis" hardware option B1.

Note: For the R&S ZNLE and the current R&S ZNL14 and R&S ZNL20 models (order nos.1323.0012.14 and 1323.0012.20) a "Spectrum Analysis" hardware option is not available.

The "I/Q Analyzer" application is described in the R&S ZNL "I/Q Analyzer" User Manual.

Remote command:

INST:SEL IQ, see [INSTrument\[:SElect\]](#) on page 529

Analog Demod

The Analog Demodulation application provides measurement functions for demodulating AM, FM, or PM signals.

The "Analog Demod" application requires a R&S ZNL equipped with the "Spectrum Analysis" hardware option B1 plus the "Analog Demodulation" software option R&S FPL1-K7.

Note: For the R&S ZNLE and the current R&S ZNL14 and R&S ZNL20 models (order nos.1323.0012.14 and 1323.0012.20) these options are not available.

For details see the Analog Demodulation Mode User Manual.

Remote command:

INST:SEL ADEM, see [INSTrument\[:SElect\]](#) on page 529

Noise Figure

The Noise Figure application provides noise figure measurements.

The "Noise Figure" application requires a R&S ZNL equipped with the "Spectrum Analysis" hardware option B1 plus the "Noise Figure Measurements" software option R&S FPL1-K30.

Note: For the R&S ZNLE and the current R&S ZNL14 and R&S ZNL20 models (order nos.1323.0012.14 and 1323.0012.20) these options are not available.

For details see the Noise Figure Measurements User Manual.

Remote command:

INST:SEL NOISE, see [INSTrument\[:SElect\]](#) on page 529

5.2 R&S MultiView

Each application is displayed in a separate tab. If more than one application is active, an additional tab ("MultiView") provides an overview of all currently active channel

setups at a glance. In the "MultiView" tab, each individual window contains its own channel setup bar. Select the channel setup bar to switch to an application quickly.

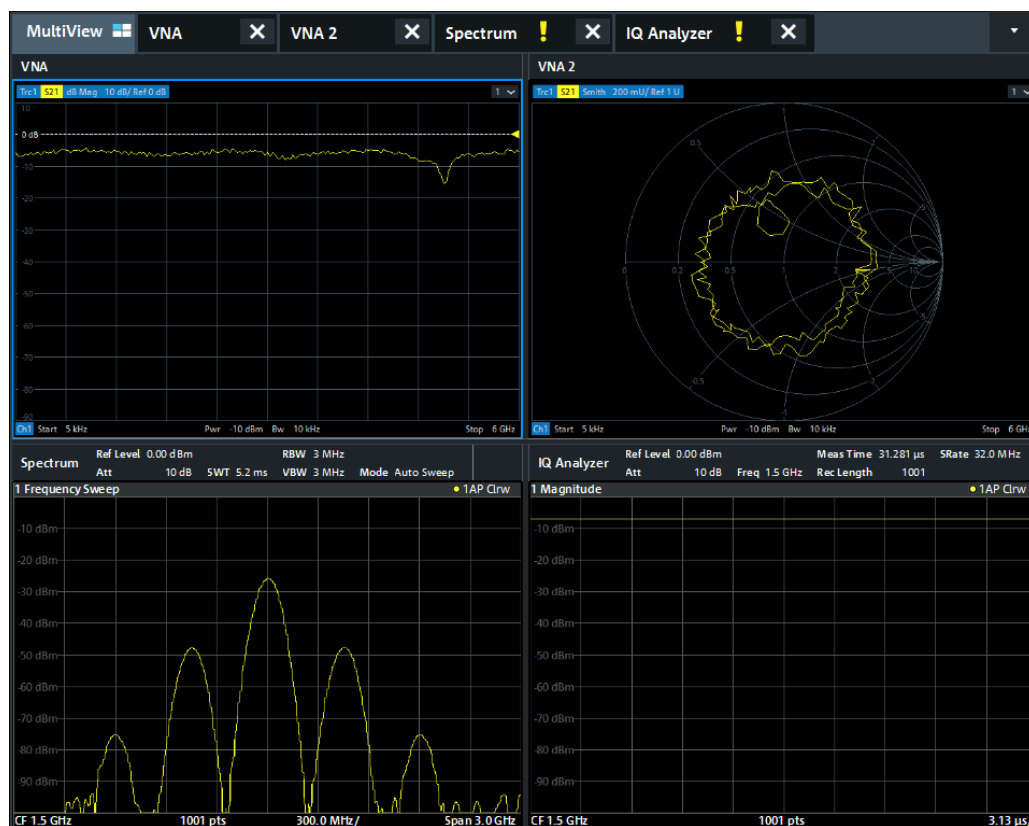

5.3 Defining Channel Setups

Access: [Mode]

For a R&S ZNL with spectrum analysis option B1, the startup/preset channel setup is determined by the [Preset Mode](#). Factory default is "VNA". For the R&S ZNLE this is the only available application.

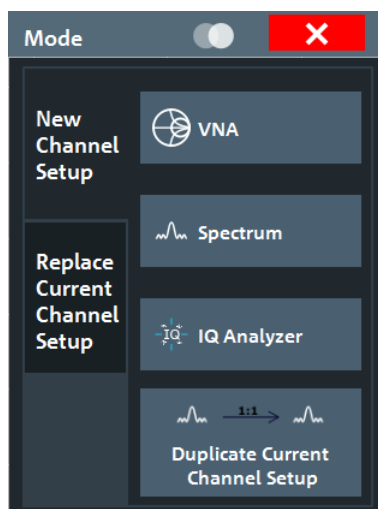

Figure 5-1: Defining Channel Setups (R&S ZNL with Spectrum Analysis option B1)

Switching between channel setups

When you switch to a new channel setup, a set of parameters is passed on from the current channel setup to the new one:

- Center frequency and frequency offset
- Reference level and reference level offset
- Attenuation

After initial setup, the parameters for the channel setup are stored upon exiting and restored upon re-entering the channel setup. Thus, you can switch between measurements quickly and easily.

Defining a channel setup.....	89
L New Channel Setup	89
L Replace Current Channel Setup	90
L Duplicate Current Channel Setup	90
Closing a channel setup.....	90

Defining a channel setup

To start a new channel setup or replace an existing one, select the corresponding application in the "Mode" dialog box.

Note: The channel setups are labeled with the application name. If that name already exists, a sequential number is added. You can change the name of the channel setup by double-tapping the name in the channel setup bar and entering a new name. For an overview of default names see [INSTRUMENT:LIST?](#) on page 528.

Remote command:

[INSTRUMENT\[:SELEct\]](#) on page 529

New Channel Setup ← Defining a channel setup

The application selected on this tab of the dialog box activates a new channel setup, i.e. a new tab in the display.

Note: The channel setups are labeled with the application name. If that name already exists, a sequential number is added. You can change the name of the channel setup by double-tapping the name in the channel setup bar and entering a new name. For an overview of default names see [INSTRUMENT:LIST?](#) on page 528.

Remote command:

[INSTRUMENT:CREATE\[:NEW\]](#) on page 527

[INSTRUMENT\[:SELECT\]](#) on page 529

Replace Current Channel Setup ← Defining a channel setup

The application selected on this tab of the dialog box is started in the currently displayed channel setup, replacing the current measurement.

Remote command:

[INSTRUMENT:CREATE:REPLACE](#) on page 527

Duplicate Current Channel Setup ← Defining a channel setup

The currently active channel setup can be duplicated, i.e. a new channel setup of the same type and with the identical measurement settings is started. The name of the new channel setup is the same as the copied channel setup, extended by a consecutive number (e.g. "Spectrum" -> "Spectrum 2").

Remote command:

[INSTRUMENT:CREATE:DUPLICATE](#) on page 526

Closing a channel setup

To close a channel setup, simply close the corresponding tab by selecting the "x" next to the channel setup name.

Remote command:

[INSTRUMENT:DELETE](#) on page 527

5.4 Running a Sequence of Measurements

Only one measurement can be performed at any time, namely the one in the currently active channel setup. However, in order to perform the configured measurements consecutively, a Sequencer function is provided.

- [The Sequencer Concept](#)..... 90
- [Sequencer Settings](#).....93
- [How to Set Up the Sequencer](#).....93

5.4.1 The Sequencer Concept

The instrument can only activate one specific channel setup at any time. Thus, only one measurement can be performed at any time, namely the one in the currently active channel setup. However, in order to perform the configured measurements consecutively, a Sequencer function is provided, which changes the channel setup of the instrument as required. If activated, the measurements configured in the currently defined "Channel"s are performed one after the other in the order of the tabs.

For each individual measurement, the sweep count is considered. Thus, each measurement may consist of several sweeps. The currently active measurement is indicated by a  symbol in the tab label.

The result displays of the individual channel setups are updated in the tabs as the measurements are performed. Sequential operation itself is independent of the currently *displayed* tab.

Sequencer modes

Three different Sequencer modes are available:

- **Single Sequence**
Similar to single sweep mode; each measurement is performed once, until all measurements in all defined "Channel"s have been performed.
- **Continuous Sequence**
Similar to continuous sweep mode; the measurements in each defined "Channel" are performed one after the other, repeatedly, in the same order, until sequential operation is stopped. This is the default Sequencer mode.
- **Channel-defined Sequence**
First, a single sequence is performed. Then, only "Channel"s in continuous sweep mode are repeated continuously.

Example: Sequencer procedure

Assume the following active channel setup definition:

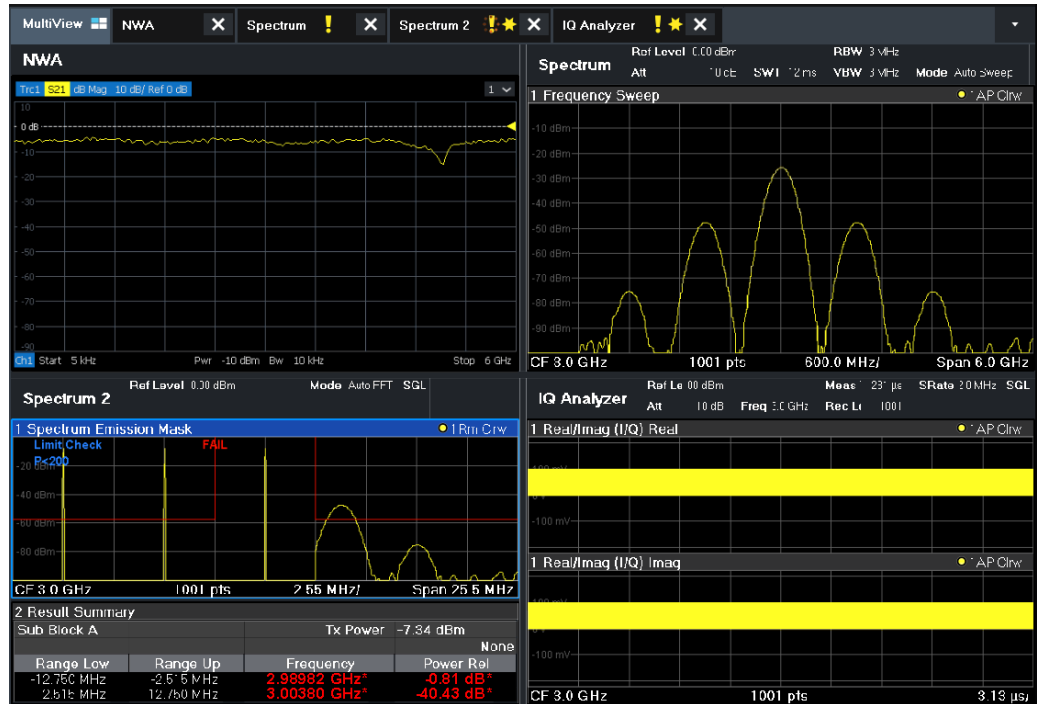

Tab name	Application	Sweep mode	Sweep count
VNA	VNA	Cont. Sweep	2
Spectrum	Spectrum	Cont. Sweep	5
Spectrum 2	Spectrum	Single Sweep	6
IQ Analyzer	IQ Analyzer	Single Sweep	7

For **Single Sequence**, the following sweeps will be performed:

2 x VNA, 5x Spectrum, 6x Spectrum 2, 7x IQ Analyzer

For **Continuous Sequence**, the following sweeps will be performed:

2 x VNA, 5x Spectrum, 6x Spectrum 2, 7x IQ Analyzer,

2 x VNA, 5x Spectrum, 6x Spectrum 2, 7x IQ Analyzer,

...

For **Channel-defined Sequence**, the following sweeps will be performed:

2 x VNA, 5x Spectrum, 6x Spectrum 2, 7x IQ Analyzer,

2 x VNA, 5x Spectrum,

2 x VNA, 5x Spectrum,

...

Run Single/Run Cont and Single Sweep/Sweep Continuous keys

While the Sequencer is active, the [Run Single] and [Run Cont] keys control the Sequencer, not individual sweeps. [Run Single] starts the Sequencer in single mode, while [Run Cont] starts the Sequencer in continuous mode.

The "Single Sweep" and "Continuous Sweep" *softkeys* control the sweep mode for the currently selected channel setup only; the sweep mode only has an effect the next time the Sequencer activates that channel setup, and only for a channel-defined sequence. In this case, a channel setup in single sweep mode is swept only once by the Sequencer. A channel setup in continuous sweep mode is swept repeatedly.

5.4.2 Sequencer Settings



The "Sequencer" menu is available from the toolbar.

Sequencer State	93
Sequencer Mode	93

Sequencer State

Activates or deactivates the Sequencer. If activated, sequential operation according to the selected Sequencer mode is started immediately.

Remote command:

`SYSTEM:SEQuencer` on page 531

`INITiate:SEQuencer:IMMediate` on page 530

`INITiate:SEQuencer:ABORt` on page 529

Sequencer Mode

Defines how often which measurements are performed. The currently selected mode softkey is highlighted blue. During an active Sequencer process, the selected mode softkey is highlighted orange.

"Single Sequence"

Each measurement is performed once, until all measurements in all active channel setups have been performed.

"Continuous Sequence"

The measurements in each active channel setup are performed one after the other, repeatedly, in the same order, until sequential operation is stopped.

This is the default Sequencer mode.

Remote command:

`INITiate:SEQuencer:MODE` on page 530

5.4.3 How to Set Up the Sequencer

In order to perform the configured measurements consecutively, a Sequencer function is provided.

1. Configure a channel setup for each measurement configuration as required, including the sweep mode.
2. In the toolbar, select the "Sequencer" icon.



The "Sequencer" menu is displayed.

3. Toggle the "Sequencer" softkey to "On".

A continuous sequence is started immediately.

4. To change the Sequencer mode and start a new sequence immediately, select the corresponding mode softkey, or press the [Run Single] or [Run Cont] key.

The measurements configured in the currently active channel setups are performed one after the other in the order of the tabs until the Sequencer is stopped. The result displays in the individual channel setups are updated as the measurements are performed.

To stop the Sequencer

- ▶ To stop the Sequencer temporarily, press the highlighted [Run Single] or [Run Cont] key (not for a channel-defined sequence). To continue the Sequencer, press the key again.
To stop the Sequencer permanently, select the "Sequencer" icon in the toolbar and toggle the "Sequencer" softkey to "Off".



Mixed VNA Operation

If the sequencer is running and both a VNA and other channel setups are active, then changing a parameter can cause the measurements to halt. If this happens, turn the sequencer "Off" and then "On" again.

6 Data Management

The R&S ZNL/ZNLE allows you to save and recall measurement settings. Measurement data can be exported and imported for a later analysis, the graphical result display can be stored to a file or printed. In addition, various application-specific data can be saved and/or recalled.

- Functions for saving and recalling measurement settings can be directly accessed via the "Store" and "Open" toolbar icons.
See [Chapter 6.2, "Storing and Recalling Instrument Settings and Measurement Data"](#), on page 96.
 - Hardcopy functions can be easily accessed via the [Print] system key.
See [Chapter 6.3, "Creating Screenshots of Current Measurement Results and Settings"](#), on page 106.
 - Trace import and export functions can be accessed via [File] > "Export" | "Import". In VNA mode this opens the "Trace" > "Trace Data" softtool tab, from where you can control the trace export or import. See [Chapter 10.6.11, "Trace Data Tab"](#), on page 367.
 - Other advanced data management functions, such as the export and import of sweep segments or limit lines, can be accessed via related softtools and dialogs.
- | | |
|--|-----|
| • Restoring the Default Instrument Configuration (Preset) | 95 |
| • Storing and Recalling Instrument Settings and Measurement Data | 96 |
| • Creating Screenshots of Current Measurement Results and Settings | 106 |

6.1 Restoring the Default Instrument Configuration (Preset)

When delivered, the R&S ZNL/ZNLE has a default configuration. You can restore this defined initial state at any time as a known starting point for measurements. This is often recommendable as a first step in troubleshooting when unusual measurement results arise.



Factory default configuration

The factory default configuration is selected such that the RF input is always protected against overload, provided that the applied signal levels are in the allowed range for the instrument.

Alternatively to the factory default settings, you can define user-specific recall settings to be restored after a preset or reboot, see ["To recall settings automatically after preset or reboot"](#) on page 105.

To restore the default instrument configuration for all channel setups at once

- ▶ Press the [PRESET] key.



After you use the [PRESET] function, the history of previous actions is deleted, i.e. any actions performed previously cannot be undone or redone using the [UNDO/REDO] keys.

Remote command:

*RST or SYSTem:PRESet

To restore the default configuration for a single channel setup

The default measurement settings can also be reset for an individual channel setup only, rather than resetting the entire instrument.

- ▶ In the "Overview", select the "Preset Channel" button.

The factory default settings are restored to the current channel setup. Note that a user-defined recall settings file is **NOT** restored.



- The procedure above applies to spectrum mode only (n.a. for R&S ZNLE).
- For the R&S ZNL/ZNLE a single channel setup can only be reset via remote control.

Remote command:

SYSTem:PRESet:CHANnel [:EXEC] on page 543

6.2 Storing and Recalling Instrument Settings and Measurement Data



Access: "Save"/ "Open" icon in the toolbar



Or: [FILE]

Possibly you would like to restore or repeat a measurement you performed under specific conditions on the instrument. Or you want to evaluate imported data in another application on the R&S ZNL/ZNLE and would like to restore the measurement settings applied during measurement. In these cases, you can store and recall instrument and measurement settings, and possibly other related measurement data.

Two different methods are available for managing instrument settings:

- Quick Save/Quick Recall - a defined set of instrument settings or channel setups are stored or recalled quickly in just one step
- Configurable Save/Recall - a user-defined set of instrument settings or channel setups are stored to a definable storage location



Restrictions when recalling measurement settings

When recalling a saved configuration file, the following restrictions apply:

- The R&S ZNL/ZNLE must support the frequency range defined in the configuration file.
- Configuration files created on a R&S ZNL/ZNLE with certain options in use do not work on an R&S ZNL/ZNLE without these options.
- Files created with newer firmware versions may not work with a previous version.
- Files created on an instrument other than the R&S ZNL/ZNLE do not work on the R&S ZNL/ZNLE.

- [Quick Save/Quick Recall](#).....97
- [Configurable Storage and Recall](#)..... 99
- [How to Save and Load Instrument Settings](#)..... 104

6.2.1 Quick Save/Quick Recall

The "Quick Save" and "Quick Recall" functions allow you to store instrument settings or channel setups very easily and quickly in one step. Up to ten different sets of settings can be stored to or recalled from "save sets". Each save set is identified by its storage date and type (instrument or specific "Channel") in the display. The save sets are stored in the C:\ProgramData\Rohde-Schwarz\ZNL-FPL\QuickSave directory, in files named QuickSave1.dfl to QuickSave10.dfl. Only the current measurement settings are stored, not any additional data such as traces, limit line or transducer files (see [Chapter 6.2.2.1, "Stored Data Types"](#), on page 99). Source calibration files for an optional external generator, if available, are included.

During recall, save sets of type "Instrument" replace the settings of the entire instrument. All other save sets start a new channel setup with the stored settings.



If a channel setup with the same name as the "Channel" to be restored is already active, the name for the new channel setup is extended by a consecutive number:



6.2.1.1 Quick Save / Quick Recall Settings



Access: "Save"/ "Open" icon in the toolbar > "Quick Save" / "Quick Recall"



Both dialog boxes are very similar and closely related.

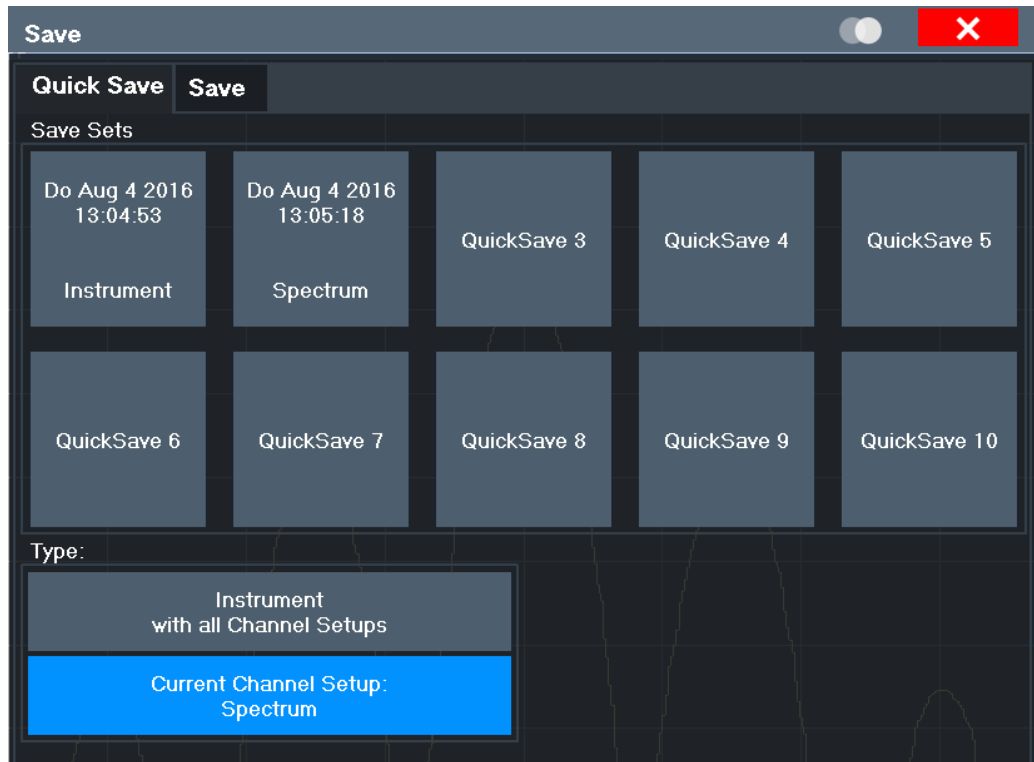

QuickSave 1 / ... / QuickSave 10..... 98

- L Rename..... 99
- L Write Protection..... 99

Storage Type (Save only)..... 99

Recall..... 99

QuickSave 1 / ... / QuickSave 10

Selects one of the save sets to store the current settings in or to be recalled. At the time of storage, the "QuickSave 1 / ... / QuickSave 10" placeholder is replaced by a label indicating the storage date and time and the storage type.

Right-click on one of the QuickSave buttons to display a context menu with additional functions for the save set.

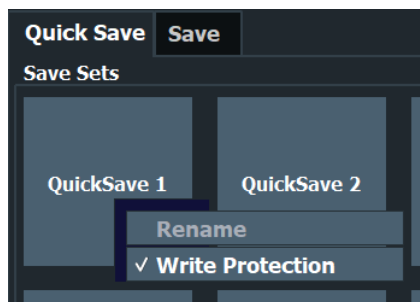

During recall, save sets of type "Instrument" replace the settings of the entire instrument. All other save sets start a new channel setup with the stored settings.

Rename ← **QuickSave 1 / ... / QuickSave 10**

Displays an input field to rename the save set, if write protection is disabled.

Write Protection ← **QuickSave 1 / ... / QuickSave 10**

Enables or disables write protection for the save set. If enabled, the save set cannot be renamed or overwritten.

Storage Type (Save only)

Defines which type of settings are stored in the save set.

"Instrument with all Channels" The instrument settings for all currently active "Channel"s are stored.

"Current Channel" Only the instrument settings for the currently selected measurement "Channel"s are stored.

Recall

Restores the instrument settings as saved in the selected settings file. If the settings file contains settings for a specific "Channel" only, a new channel setup with the stored settings is activated, otherwise all "Channel"s and instrument settings are overwritten with the stored settings.

Note: After you use the "Recall" function, the history of previous actions is deleted, i.e. any actions performed previously cannot be undone or redone using the [UNDO/REDO] keys.

Remote command:

[MMEMory:LOAD:STATe](#) on page 540

6.2.2 Configurable Storage and Recall

The more sophisticated storage and recall functions allow you to define which settings are stored, and where the settings file is stored to. Any settings file can be selected for recall.

- [Stored Data Types](#)..... 99
- [Storage Location and Filename](#)..... 100
- [Save and Recall Dialog Boxes](#)..... 100
- [Startup Recall Settings](#)..... 102

6.2.2.1 Stored Data Types

The following types of data can be stored to and loaded from files via the "Save" dialog box on the R&S ZNL/ZNLE:

Table 6-1: Items that can be stored to files

Item	Description
Current Settings	Current instrument and measurement settings.

6.2.2.2 Storage Location and Filename

The data is stored on the internal flash disk or, if selected, on a memory stick or network drive. The operating system, firmware and stored instrument settings are located on drive C.

The storage location and filename are selected in a file selection dialog box which is displayed when you perform a storage function.

By default, the name of a settings file consists of a base name followed by an underscore and three numbers, e.g. `limit_lines_005`. In the example, the base name is `limit_lines`. The base name can contain characters, numbers and underscores. The file extension `df1` is added automatically. The default folder for settings files is `C:\ProgramData\Rohde-Schwarz\ZNL-FPL\Save`.



File name restrictions

File names must be compatible with the Windows conventions for file names. In particular, they must not contain special characters such as ":", "*", "?".

6.2.2.3 Save and Recall Dialog Boxes



Access: "Save"/ "Open" icon in the toolbar > "Save" / "Recall"



Both dialog boxes are very similar and closely related.

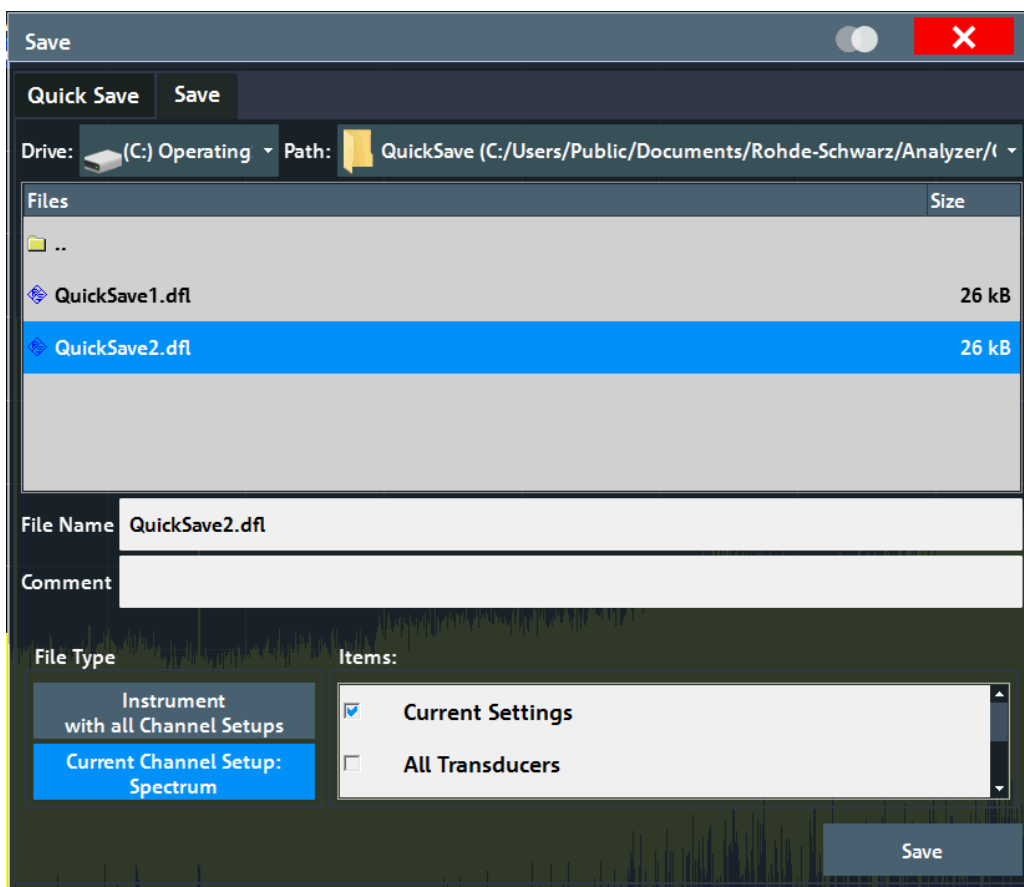

Selecting Storage Location - Drive/ Path/ Files.....	101
File name.....	101
Comment.....	101
File Explorer.....	102
File Type	102
Items:.....	102
Save File.....	102
Recall in New Channel / Recall in Current Channel.....	102

Selecting Storage Location - Drive/ Path/ Files

Select the storage location of the file on the instrument or an external drive.

File name

Contains the name of the data file without the path or extension.

File names must be compatible with the Windows conventions for file names. In particular, they must not contain special characters such as ":", "*", "?".

Comment

An optional description for the data file. A maximum of 60 characters can be displayed.

Remote command:

[MMEMory: COMMEnt](#) on page 535

File Explorer

Opens the Microsoft Windows File Explorer.

Remote command:

not supported

File Type

Determines whether the global instrument settings with all "Channel"s are stored or recalled, or the current "Channel" settings only.

Items:

Defines which data and settings are stored or are recalled. Depending on the "File Type" , either channel setups only, or global settings are available. Which items are available also depends on the installed options (see also [Chapter 6.2.2.1, "Stored Data Types"](#), on page 99).

Save File

Saves the settings file with the defined filename.

Remote command:

[MMEMory:STORe<1|2>:STATe](#) on page 542

[MMEMory:STORe<1|2>:STATe:NEXT](#) on page 542

Recall in New Channel / Recall in Current Channel

Restores the instrument settings as saved in the selected settings file. If the settings file contains settings for a specific "Channel" only, select "Recall in New Channel" to activate a new channel setup with the stored settings. Select "Recall in Current Channel" to replace the current "Channel" settings.

Note: After you use the "Recall" function, the history of previous actions is deleted, i.e. any actions performed previously cannot be undone or redone using the [UNDO/REDO] keys.

Remote command:

[MMEMory:LOAD:STATe](#) on page 540

6.2.2.4 Startup Recall Settings

Access: "Open" icon in the toolbar > "Startup Recall"

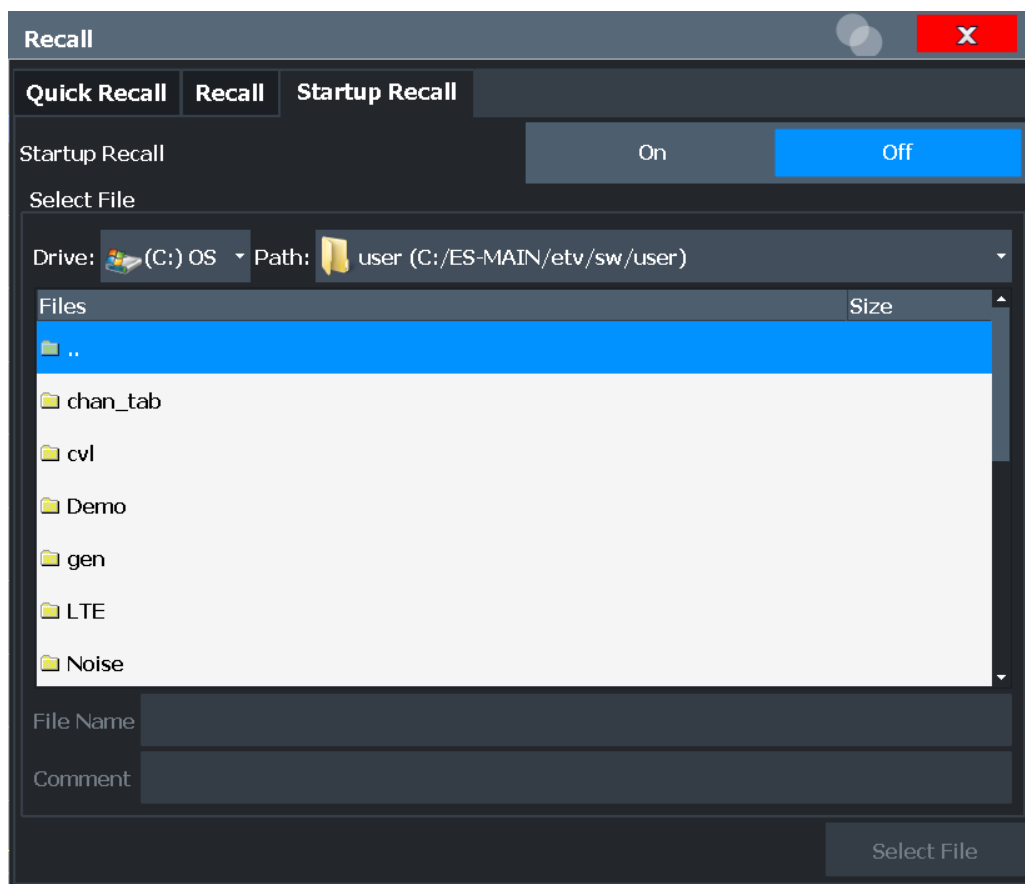

Startup Recall.....	103
Selecting Storage Location - Drive/ Path/ Files.....	103
File name.....	103
Comment.....	104

Startup Recall

Activates or deactivates the startup recall function. If activated, the settings stored in the selected file are loaded each time the instrument is started or preset. If deactivated, the default settings are loaded.

Note that only *instrument* settings files can be selected for the startup recall function, not "Channel" files.

Remote command:

`MMEMoRY:LOAD:AUTO` on page 540

Selecting Storage Location - Drive/ Path/ Files

Select the storage location of the file on the instrument or an external drive.

File name

Contains the name of the data file without the path or extension.

File names must be compatible with the Windows conventions for file names. In particular, they must not contain special characters such as ":", "*", "?".

Comment

An optional description for the data file. A maximum of 60 characters can be displayed.

Remote command:

[MMEMoRY:COMMeNT](#) on page 535

6.2.3 How to Save and Load Instrument Settings

Instrument settings can be saved to a file and loaded again later, so that you can repeat the measurement with the same settings. Optionally, user-defined measurement settings can automatically be restored each time you start or preset the instrument.

To save and recall instrument settings using the Quick Save function

1. Select the "Save" icon from the toolbar.
2. Select whether the instrument settings for **all** "Channel"s are stored, or only those for the **current** "Channel".
3. Select one of the save sets in which the settings are stored ("QuickSaveX").

The selected settings are stored to the file

```
C:\ProgramData\Rohde-Schwarz\ZNL-FPL\QuickSave\
QuickSaveX.dfl.
```

Note: If you make any changes to the settings *after* storing the configuration file, remember to save the settings again. Otherwise those settings cannot be restored and will be overwritten by the stored values when the configuration file is recalled.



4. To restore the settings, select the "Open" icon from the toolbar.
5. Select the save set in which the settings were stored ("QuickSaveX").
The selected settings are restored to the instrument or channel setup.

To save configurable instrument settings

1. Select the "Save" icon from the toolbar.
2. In the "Save" dialog box, switch to the "Save" tab.
3. In the file selection dialog box, select a filename and storage location for the settings file.
4. Optionally, define a comment to describe the stored settings.
5. Select whether the instrument settings for **all** "Channel"s are stored, or only those for the **current** "Channel".
6. Select the items to be saved with the settings. Either the settings for the currently selected "Channel" only, or the settings for all "Channel"s can be stored. Various

other items, such as lines or traces etc., can be stored as well (see [Chapter 6.2.2.1, "Stored Data Types"](#), on page 99).

7. Select "Save".

A file with the defined name and path and the extension `.df1` is created.



If you make any changes to the settings *after* storing the configuration file, remember to save the settings again. Otherwise those settings cannot be restored and will be overwritten by the stored values when the configuration file is recalled.

To recall configurable instrument settings



1. Select the "Open" icon from the toolbar.
2. In the "Recall" dialog box, switch to the "Recall" tab.
3. In the file selection dialog box, select the filename and storage location of the settings file.

Note: The "File Type" indicates whether the file contains instrument settings for **all** "Channel"s, or only those for the current "Channel".
4. If several items were saved, select which items are restored.
5. If a "Channel" was saved, select whether the settings will replace the settings in the current "Channel", or whether a new channel setup with the saved settings will be opened.
6. Select "Recall".

The settings and selected items from the saved measurement are restored and you can repeat the measurement with the same settings.

Note that any changes made to the settings *after* storing the configuration file will be overwritten by the stored values when the configuration file is recalled.



In case the channel setup could only be loaded after adjusting some incompatible VNA settings, the info message **"The setup data changed while loading"** is displayed. This may happen, for example, if you attempt to load a channel setup of a different R&S ZNL/ZNLE model or with different optioning.

To recall settings automatically after preset or reboot

You can define the settings that are restored when you preset or reboot the instrument.

1. Configure the settings as required and save them as described in ["To save configurable instrument settings"](#) on page 104.
2. In the "Save/Recall" menu, select "Startup Recall".
3. From the file selection dialog box, select the recall settings to restore.
4. Select "Select File".

5. Set "Startup Recall" to "On".
Now when you press the [PRESET] key or reboot the instrument, the defined settings will be restored.
6. To restore the factory preset settings, set "Startup Recall" to "Off".

6.3 Creating Screenshots of Current Measurement Results and Settings

To document the graphical results and the most important settings for the currently performed measurement, you can create a screenshot of the current display. Screenshots can either be printed or stored to a file.

- [Print and Screenshot Settings](#).....106
- [How to Store or Print Screenshots of the Display](#)..... 116

6.3.1 Print and Screenshot Settings

Access: [Print]

For step-by-step instructions, see [Chapter 6.3.2, "How to Store or Print Screenshots of the Display"](#), on page 116.

Remote commands for these settings are described in [Chapter 11.3.3.3, "Storing or Printing Screenshots"](#), on page 544.



To print a screenshot of the current display with the current settings immediately, without switching to the "Print" menu, use the "Print immediately" icon in the toolbar.

- [Print Content Settings](#)..... 106
- [Print Preview Functions](#)..... 109
- [Printer Settings](#)..... 111
- [Page Setup](#)..... 114
- [Print Color Settings](#)..... 115

6.3.1.1 Print Content Settings



Access: "Print" > "Print Config" > "Content" tab

The content settings determine which data is included in the printout.

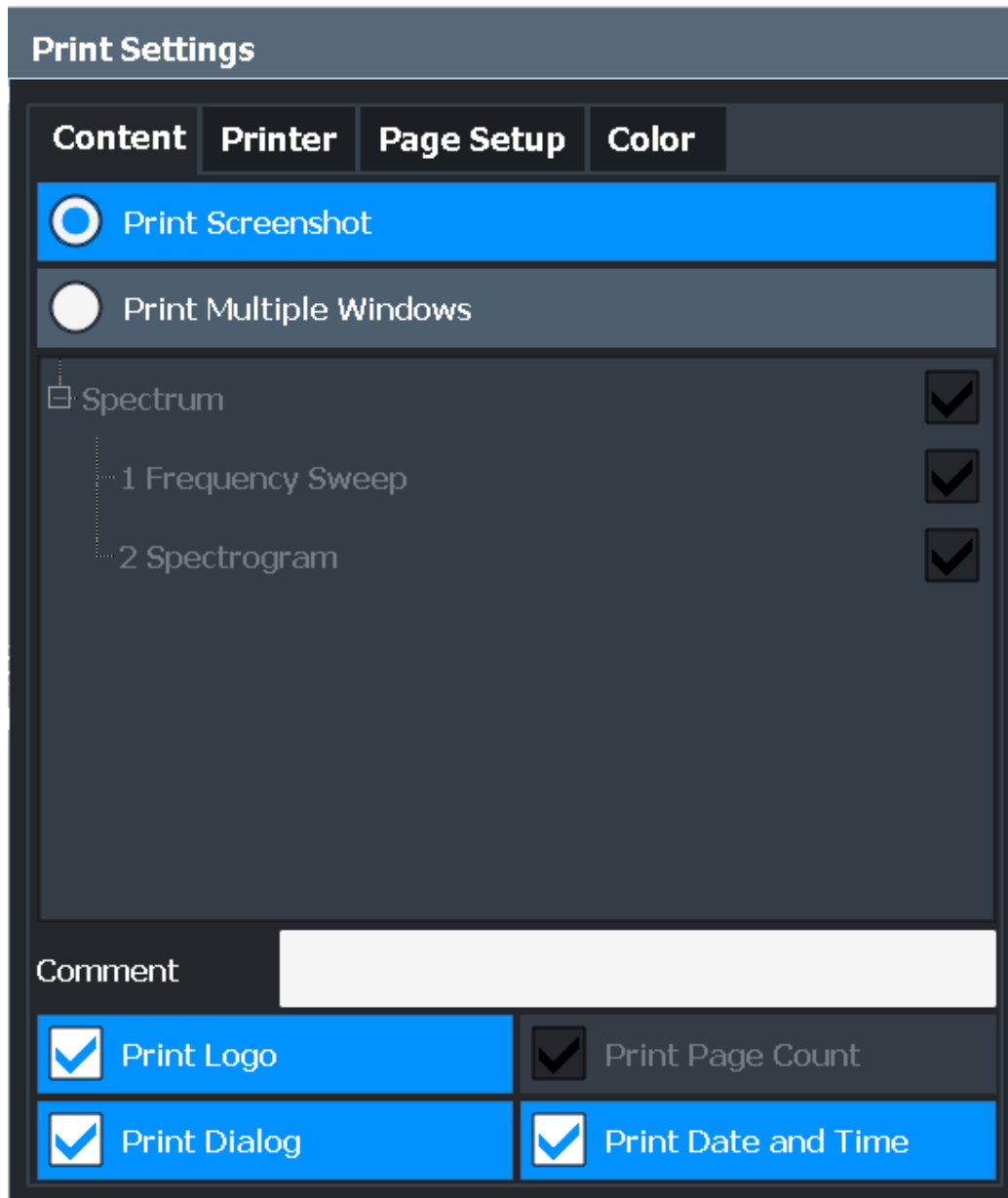

Print Screenshot.....	108
Print Multiple Windows.....	108
Comment.....	108
Print Logo.....	108
Print Page Count.....	108
Print Dialog.....	108
Print Date and Time.....	109

Print Screenshot

Selects all measurement results displayed on the screen for the current channel setup (or "MultiView"): diagrams, traces, markers, marker lists, limit lines, etc., including the channel bar and status bar, for printout on a single page. Displayed items belonging to the software user interface (e.g. softkeys) are not included. The position and size of the elements in the printout is identical to the display.

Remote command:

[HCOPY:CONTent](#) on page 545

Print Multiple Windows

Includes only the selected windows in the printout. All currently active windows for the current channel setup (or "MultiView") are available for selection. How many windows are printed on a single page of the printout is user-definable (see "[Windows Per Page](#)" on page 115).

This option is only available when printing on a printer or to a PDF file (see "[Destination](#)" on page 112). If the [Destination](#) is currently set to an image file or the clipboard, it is automatically changed to be a PDF file.

Remote command:

[HCOPY:CONTent](#) on page 545

[HCOPY:PAGE:WINDow<1|2>:STATe](#) on page 552

[HCOPY:PAGE:WINDow<1|2>:CHANnel:STATe](#) on page 551

Comment

Defines an optional comment to be included in the printout of the display. Maximum 120 characters are allowed. Up to 60 characters fit in one line. In the first line, a manual line-feed can be forced at any point by entering "@".

The comment is printed in the top left corner of each printout page. If a comment should not be printed, it must be deleted.

Tip: The current date and time can be inserted automatically, see "[Print Date and Time](#)" on page 109.

Remote command:

[HCOPY:ITEM:WINDow<1|2>:TEXT](#) on page 548

Print Logo

Activates/deactivates the printout of the Rohde & Schwarz company logo in the upper right corner.

Remote command:

[DISPlay:LOGO](#) on page 544

Print Page Count

Includes the page number for printouts consisting of multiple windows ("[Print Multiple Windows](#)" on page 108).

Remote command:

[HCOPY:PAGE:COUNt:STATe](#) on page 549

Print Dialog

Includes any currently displayed dialog in the screenshot printout.

This setting is only available if [Print Screenshot](#) is selected.

Print Date and Time

Includes or removes the current date and time at the bottom of the printout.

Remote command:

[HCOPY:TDSTamp:STATe<1|2>](#) on page 553

6.3.1.2 Print Preview Functions

Access: "Print"

The "Print Preview" of the printout according to the current configuration is available in all "Print Settings" dialog tabs.



Zoom In / Zoom Out.....	110
Fit Page.....	111
Zoom 1:1.....	111
Page Up / Page Down.....	111
Print.....	111

Zoom In / Zoom Out

Zooms into (enlarges) or zooms out of (decreases) the preview display. Note that the zoom functions affect only the preview, not the printout itself.

Fit Page

Adapts the preview display zoom factor so that one complete page is visible as large as possible in the available display space. Note that the zoom functions affect only the preview, not the printout itself.

Zoom 1:1

Displays the printout in its original size, as it will be printed.

Page Up / Page Down

Depending on the selected contents (see [Chapter 6.3.1.1, "Print Content Settings"](#), on page 106), the printout can consist of multiple pages. Use these functions to scroll within the preview to see the individual pages.

Print

Starts to print or store the selected screen contents to a file (see [Chapter 6.3.1.1, "Print Content Settings"](#), on page 106).

Whether the output is sent to the printer or stored in a file or the clipboard depends on the selected print settings (see [Chapter 6.3.1.3, "Printer Settings"](#), on page 111).

If the output is stored to a file, a file selection dialog box is opened to select the file-name and location. The default path is C:\Users\Public\Documents\Rohde-Schwarz\ZNL\user.

Remote command:

[HCOPY\[:IMMEDIATE<1|2>\]](#) on page 548

[HCOPY\[:IMMEDIATE<1|2>\]:NEXT](#) on page 548

6.3.1.3 Printer Settings

Access: "Print" > "Print Config" > "Printer" tab

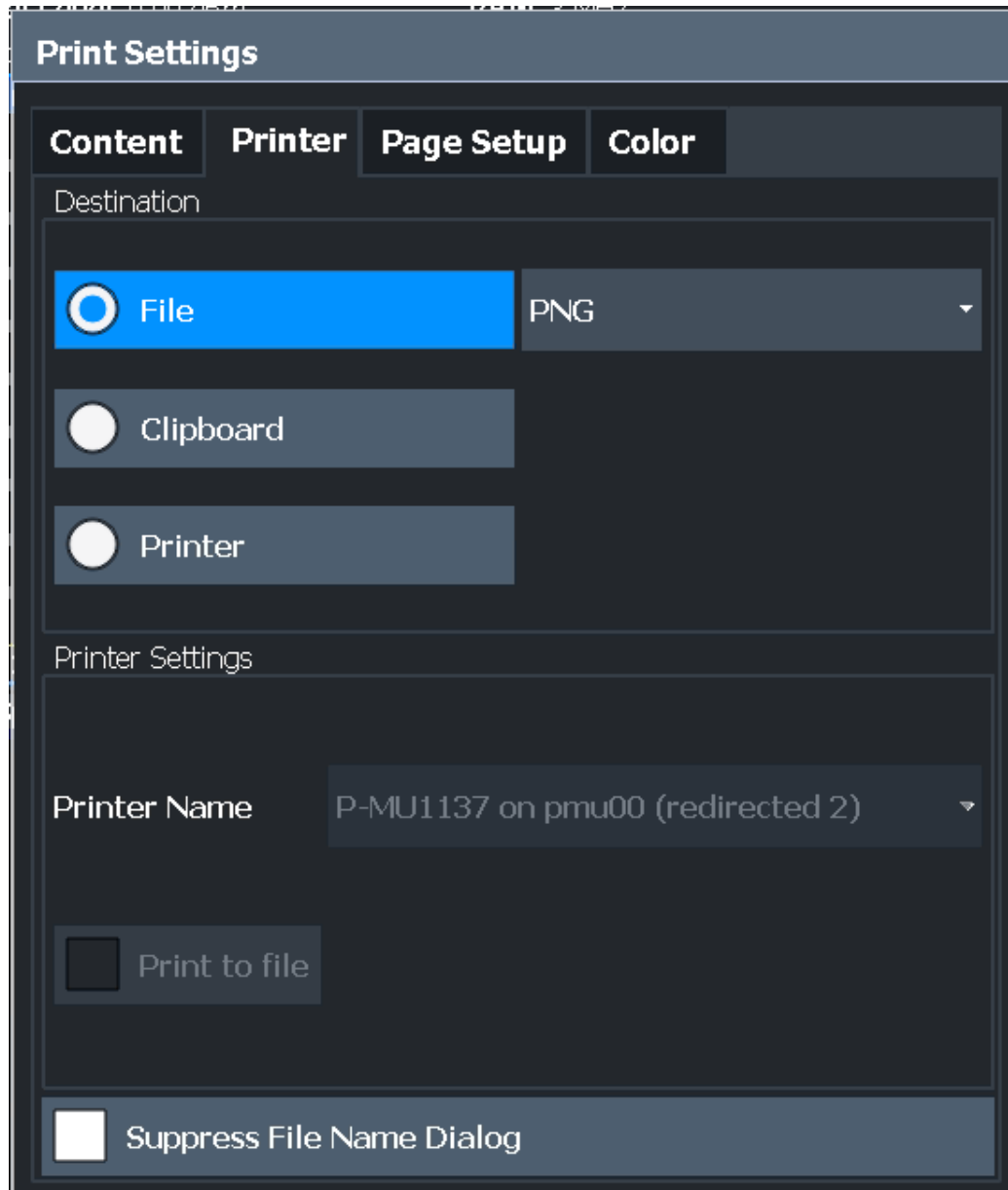

Print Settings

Content **Printer** **Page Setup** **Color**

Destination

File PNG

Clipboard

Printer

Printer Settings

Printer Name P-MU1137 on pmu00 (redirected 2)

Print to file

Suppress File Name Dialog

Destination.....	112
L Destination: File.....	113
L Destination: Clipboard.....	113
L Destination: Printer.....	113
Suppress File Name Dialog.....	113
Printer Name.....	113
Print to file.....	113
Install Printer.....	114

Destination

Defines the medium to which the printout is output.

Creating Screenshots of Current Measurement Results and Settings

Destination: File ← Destination

Stores the printout to a file in the selected format. The filename is queried at the time of storage, or a default name is used (see [Suppress File Name Dialog](#)).

Multiple windows can only be printed to a file in PDF format. If you select an image file format, the content setting is automatically set to [Print Screenshot](#). Page settings are not available for image files; however, you can configure the colors used for the screenshot (see [Chapter 6.3.1.5, "Print Color Settings"](#), on page 115).

Remote command:

`HCOPY:DEVIce:LANGUage<1|2>` on page 547

Destination: Clipboard ← Destination

Copies the printout to the clipboard. Since only single pages can be copied, only screenshots can be copied to this destination, not multiple windows (see [Chapter 6.3.1.1, "Print Content Settings"](#), on page 106). Page settings are not available; however, you can configure the colors used for the screenshot (see [Chapter 6.3.1.5, "Print Color Settings"](#), on page 115).

If you select the clipboard as the printing destination, the content setting is automatically set to [Print Screenshot](#).

Remote command:

`HCOP:DEST1 'SYSTEM:COMMunicate:CLIPboard'`

Destination: Printer ← Destination

Sends the printout to the printer selected from the [Printer Name](#) list.

Remote command:

`HCOP:DEST1 'SYSTEM:COMMunicate:PRINter'`

Suppress File Name Dialog

If the [Destination](#) is a file, the file selection dialog box is not displayed. Instead, the default storage location and filename are used.

`(C:\Users\Public\Documents\Rohde-Schwarz\ZNL\user
\ZNL_ScreenShot_<date and time>).`

Printer Name

Defines the printer to print to if a printer is selected as the [Destination](#).

Any printers detected in the network are listed for selection.

Tip: the printout can also be stored in a print file using the selected printer driver, see ["Print to file"](#) on page 113.

Remote command:

`SYSTEM:COMMunicate:PRINter:ENUMerate[:NEXT]` on page 553

`SYSTEM:COMMunicate:PRINter:ENUMerate:FIRSt` on page 553

`SYSTEM:COMMunicate:PRINter:SElect<1|2>` on page 553

Print to file

If a printer is selected as the [Destination](#), use this option to store the data in a `.prn` file using the selected printer driver.

Remote command:

To enable: `HCOP:DEST1 'MMEM'`

To disable: `HCOP:DEST1 'SYSTEM:COMMunicate:PRINter'`

Install Printer

This softkey opens the standard Windows dialog box to install a new printer. All printers that are already installed are displayed.

Only user accounts with administrator rights can install a printer.

For further information, refer to the Microsoft Windows documentation.

6.3.1.4 Page Setup



Access: "Print" > "Print Config" > "Page Setup" tab

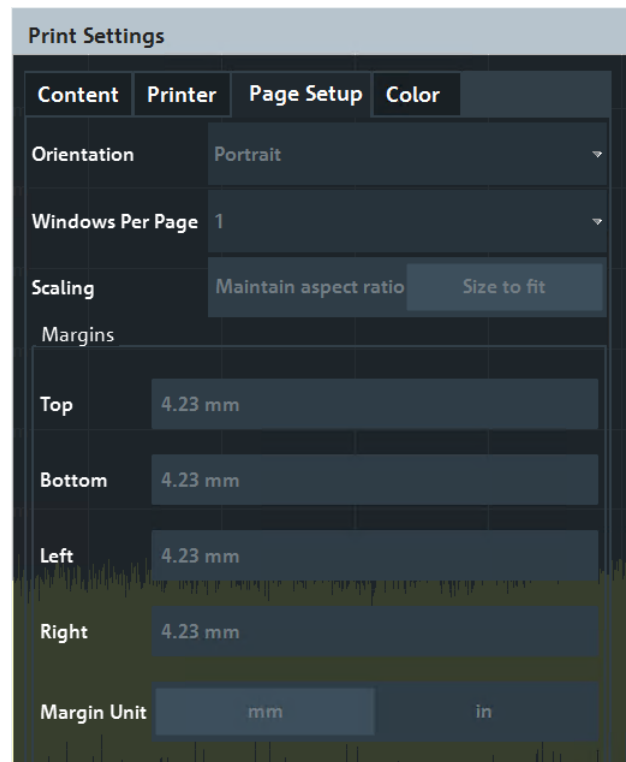

Page settings are only available when printing on a printer or to a PDF file (see "[Destination](#)" on page 112).

Orientation	114
Windows Per Page	115
Scaling	115
Margins	115

Orientation

Selects the page orientation of the printout: portrait or landscape.

Remote command:

`HCOPY:PAGE:ORIENTATION<1|2>` on page 551

Windows Per Page

Defines how many windows are displayed on a single page of the printout. This setting is only available if [Print Multiple Windows](#) is active (see [Chapter 6.3.1.1, "Print Content Settings"](#), on page 106).

If more than one window is printed on one page, each window is printed in equal size.

Remote command:

`HCOPY:PAGE:WINDow<1|2>:COUNT` on page 551

Scaling

Determines the scaling of the windows in the printout if [Print Multiple Windows](#) is active (see [Chapter 6.3.1.1, "Print Content Settings"](#), on page 106).

If more than one window is printed on one page (see [Windows Per Page](#)), each window is printed in equal size.

"Maintain aspect ratio" Each window is printed as large as possible while maintaining the aspect ratio of the original display.

"Size to fit" Each window is scaled to fit the page size optimally, not regarding the aspect ratio of the original display.

Remote command:

`HCOPY:PAGE:WINDow<1|2>:SCALE` on page 552

Margins

Defines margins for the printout page on which no elements are printed. The margins are defined according to the selected unit.

Remote command:

`HCOPY:PAGE:MARGIN<1|2>:BOTTom` on page 549

`HCOPY:PAGE:MARGIN<1|2>:LEFT` on page 549

`HCOPY:PAGE:MARGIN<1|2>:RIGHT` on page 550

`HCOPY:PAGE:MARGIN<1|2>:TOP` on page 550

`HCOPY:PAGE:MARGIN<1|2>:UNIT` on page 550

6.3.1.5 Print Color Settings

Access: "Print" > "Print Config" > "Color" tab

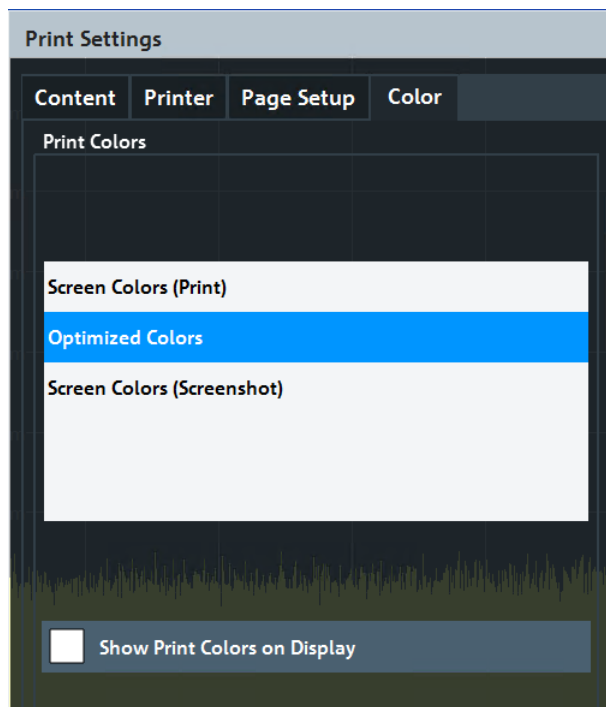

The settings provided here are identical to those in the "Print Colors" section of the "Display" > "Theme + Color" dialog box.

See ["Print Colors"](#) on page 126.

6.3.2 How to Store or Print Screenshots of the Display

The measurement results displayed on the screen can be printed or stored to a file very easily.



For a programming example, see [Chapter 11.3.3.5, "Examples: Managing Data"](#), on page 554.

To start printing or storing results to a file



- ▶ If the R&S ZNL/ZNLE has already been set up according to your current requirements, simply press the "Print immediate" icon at the far right end of the toolbar.
The current measurement display is printed or stored to a file, as configured.

To print a screenshot

This configuration assumes a printer has already been installed. To install a new printer, use the [Install Printer](#) function (common Microsoft Windows procedure).



1. Select the "Printer" tool in the toolbar.
The "Print Settings" dialog box is displayed.

Creating Screenshots of Current Measurement Results and Settings

2. In the "Content" tab, define the elements of the screen and additional information to be included in the printout.
 - a) Select "Print Screenshot" to include all elements displayed on the screen in a single-page printout.
 - b) Optionally, add a comment to be printed at the top of the printout.
 - c) Optionally, activate the date and time or the logo so they are added to the printout.
 - d) Optionally, activate "Print Dialog" to include any dialog boxes currently displayed on the screen in the printout. This is useful, for example, to document the used settings for a particular result.
 - e) Check the "Print Preview" to make sure all relevant elements of the display are visible.
3. In the "Printer" tab, select "Printer" as the "Destination".
4. Select the "Printer Name" to print to from the list of installed printers.
5. In the "Page Setup" tab, configure the layout of the printout page.
 - a) Select the page orientation.
 - b) Define the page margins.
 - c) Check the "Print Preview" to make sure all relevant elements of the display are visible.
6. In the "Color" tab, define the colors to be used for the printout.
 - a) By default, "Optimized Colors" are used to improve the visibility of the colors. The background is always printed in white and the grid in black. For a printout that reflects exactly what you see on the screen, select "Screen Colors (Screenshot)".
 - b) Check the "Print Preview" to find out if the setting is appropriate.
7. Select "Print" to execute the print function.

The screenshot is printed on the printer as configured.
8. To print another screenshot using the same configuration any other time, simply press the "Print immediate" icon at the far right end of the toolbar.

**To store a printout containing multiple windows**

1. Select the "Printer" tool in the toolbar.

The "Print Settings" dialog box is displayed.
2. In the "Content" tab, define the elements of the screen and additional information to be included in the printout.
 - a) Select "Print Selected Windows" to include the selected windows in the printout, possibly on multiple pages.

Creating Screenshots of Current Measurement Results and Settings

- b) Select the result displays in the currently selected channel setup to be included in the printout.
Tip: Select the "MultiView" before configuring the printout to include result displays from any active channel setup.
 - c) Optionally, add a comment to be printed at the top of each page of the printout.
 - d) Optionally, activate the date and time or the logo so they are added to the printout pages.
3. Check the "Print Preview" to make sure all required result displays are included.
 - a) Scroll through the individual pages of the printout using "Page Up" and "Page Down".
 - b) Use the zoom functions to make sure all relevant parts of the result display are visible.
 4. In the "Printer" tab, select "File" as the "Destination".
 5. Select the file format from the selection list.
 6. By default, you define the filename individually for each print operation. To avoid having the "File Selection" dialog box being displayed for each print operation, select "Suppress File Name Dialog". In this case, the previously used or default storage location and filename are used.
 (C:\Users\Public\Documents\Rohde-Schwarz\ZNL\user\
 ZNL_ScreenShot_<date and time>).
 7. In the "Page Setup" tab, configure the layout of the printout page.
 - a) Select the page orientation.
 - b) Define the page margins.
 - c) Check the "Print Preview" to make sure all relevant elements of the display are visible.
 8. In the "Color" tab, define the colors to be used for the printout.
 - a) By default, "Optimized Colors" are used to improve the visibility of the colors. The background is always printed in white and the grid in black. For a printout that reflects the colors you see on the screen, but with a white background, select "Screen Colors (Print)".
 - b) Check the "Print Preview" to find out if the setting is appropriate.
 9. Select "Print" to execute the print function.
 10. If you did not select the option to suppress the dialog, enter a filename in the file selection dialog box.
 The selected data elements are stored to the file as configured.
 11. To store another file using the same configuration any other time, simply press the "Print immediate" icon at the far right end of the toolbar.



7 General Instrument Setup

Access: [SETUP]

Some basic instrument settings can be configured independently of the selected operating mode or application. Usually, you configure most of these settings initially when you set up the instrument according to your personal preferences or requirements. Then you only adapt individual settings to special circumstances when necessary. Some special functions are provided for service and basic system configuration.



Network and remote settings

Settings for network and remote operation are described in [Chapter 8.4, "Network and Remote Control Settings"](#), on page 156.

Settings for the optional "Spectrum" mode are described in the R&S ZNL/ZNLE "Spectrum" mode user manual.

- [Reference Frequency](#)..... 119
- [Display Settings](#)..... 120
- [Language Settings](#)..... 129
- [System Configuration Settings](#)..... 129
- [Service Functions](#)..... 136
- [VNA Setup](#)..... 141
- [Toolbar Configuration](#)..... 147

7.1 Reference Frequency

Access: [Setup] > "Reference Int/Ext"

The R&S ZNL/ZNLE can use the internal reference source or an external reference source as the frequency standard for all internal oscillators. A 10 MHz crystal oscillator is used as the internal reference source. In the external reference setting, all internal oscillators of the R&S ZNL/ZNLE are synchronized to the external reference frequency.

External references are connected to one of the [REF INPUT] connectors on the rear panel. For details see the R&S ZNL/ZNLE "Getting Started" manual.

The default setting is the internal reference. When an external reference is used, "EXT REF" is displayed in the status bar.



OCXO Option

The OCXO (R&S FPL1-B4) option generates a 10 MHz reference signal with a very precise frequency. If installed, and if no external signal is used, this signal is used as an internal reference. It can also be used to synchronize other connected devices via the Ref. Out 10 MHz connector.

This option is not available for the R&S ZNLE

When the instrument is switched on, the OCXO requires an extended warm-up time (see data sheet).

Remote command:

`[SENSe:]ROSCillator:SOURce` on page 558

7.2 Display Settings

7.2.1 Display Settings

Access: [Setup] > "Display"

Some general display settings are available regardless of the current application or operating mode. For information on optimizing your display for measurement results, see the application-specific result configuration descriptions.

- [General Display Settings](#)..... 120
- [Displayed Items](#)..... 122
- [Display Theme and Colors](#)..... 125
- [External Monitor Settings](#)..... 127

7.2.1.1 General Display Settings

Access: [Setup] > "Display" > "General"

This section includes general screen display behavior and date and time display.

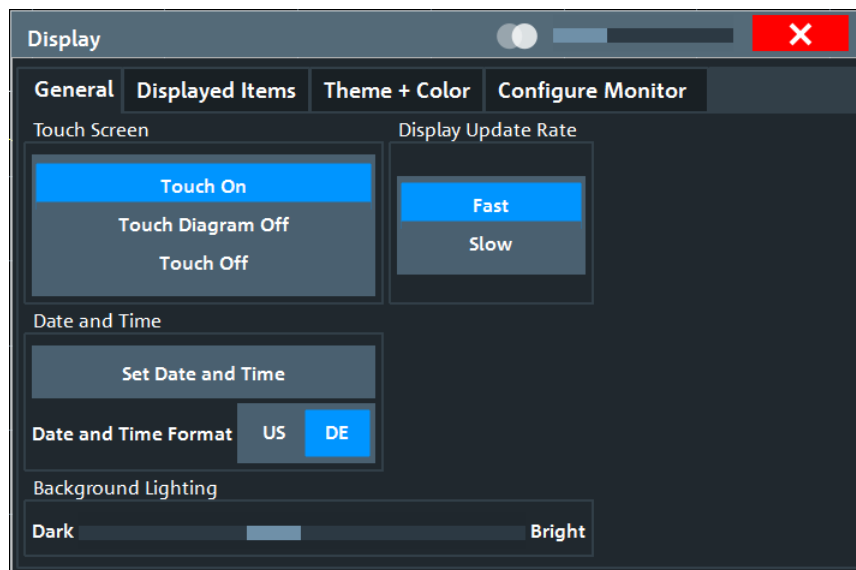

Deactivating and Activating the Touchscreen.....	121
Display Update Rate.....	121
Set Date and Time	121
Date and Time Format	122
Background Lighting.....	122

Deactivating and Activating the Touchscreen

The touchscreen function can be deactivated, e.g. when the instrument is being used for demonstration purposes and tapping the screen must not provoke an action.

To reactivate the touchscreen, simply press the [Setup] key on the front panel. The "Display" dialog box is opened automatically and the "Touch Screen" option is set to "On".

- "Touch On" Touchscreen function is active for the entire screen.
- " Touch Off" Touchscreen is deactivated for the entire screen.
- " Touch Diagram Off"
Touchscreen is deactivated for the diagram area of the screen, but active for the surrounding softkeys, toolbars and menus.

Remote command:

`DISPlay:TOUChscreen[:STATe]` on page 563

Display Update Rate

By default, a fast update rate ensures the most recent measurement results on the display. However, when performance is poor due to slow data transfer (for example during remote control), it can be helpful to decrease the frequency with which the screen display is updated.

Set Date and Time

Sets the current date and time for the internal real-time clock on the instrument. This function uses the standard Windows "Date and Time Properties" dialog box. Setting the clock requires administrator rights.

Select the "Set Date and Time" button in the "Display" dialog box, or select the date and time display in the status bar to open the Windows dialog box.

Remote command:

[SYSTem:DATE](#) on page 564

[SYSTem:TIME](#) on page 565

Date and Time Format

Switches the time and date display on the screen between US and German (DE) format.

Remote command:

[DISPlay\[:WINDow<n>\]:TIME:FORMat](#) on page 564

Background Lighting

Changes the brightness of the display in eight steps.

Remote command:

[DISPlay:BLIGHTing](#) on page 562

7.2.1.2 Displayed Items

Access: [Setup] > "Display" > "Displayed Items"

Several elements on the screen display can be hidden or shown as required, for example to enlarge the display area for the measurement results.

General	Displayed Items	Theme + Color	Configure Monitor	Touch
Toolbar	<input checked="" type="checkbox"/> On <input type="checkbox"/> Off		Status Bar	<input checked="" type="checkbox"/> On <input type="checkbox"/> Off
Softkey Bar	<input checked="" type="checkbox"/> On <input type="checkbox"/> Off		Channel Bar	<input checked="" type="checkbox"/> On <input type="checkbox"/> Off
Annotation	<input checked="" type="checkbox"/> On <input type="checkbox"/> Off		Date and Time	<input checked="" type="checkbox"/> On <input type="checkbox"/> Off
Front Panel	<input checked="" type="checkbox"/> On <input type="checkbox"/> Off		Mini Front Panel	<input type="checkbox"/> On <input checked="" type="checkbox"/> Off
Disconnect RF	<input checked="" type="checkbox"/> On <input type="checkbox"/> Off		Frequency Lock	<input checked="" type="checkbox"/> On <input type="checkbox"/> Off

[Toolbar](#)..... 123

[Status Bar](#)..... 123

[Softkey Bar](#)..... 123

[Channel Bar](#)..... 123

[Diagram Footer \(Annotation\)](#)..... 123

[Date and Time](#)..... 123

[Front Panel](#)..... 124

[Mini Front Panel](#)..... 124

Toolbar

The toolbar provides access to frequently used functions via icons at the top of the screen. Some functions, such as zooming, finding help, printing screenshots or storing and loading files are not accessible at all without the toolbar.

Remote command:

`DISPlay:TBAR[:STATe]` on page 563

Status Bar

The status bar beneath the diagram indicates the global instrument settings, the instrument status and any irregularities during measurement or display.

Some of the information displayed in the status bar can be queried from the status registry via remote commands.

Remote command:

`DISPlay:SBAR[:STATe]` on page 562

Softkey Bar

Softkeys are virtual keys provided by the software. Thus, more functions can be provided than can be accessed directly via the function keys on the device.

The functions provided by the softkeys are often also available via dialog boxes. However, some functions are not accessible at all without the softkey bar.

The softkey bar can be hidden temporarily to provide more space for the result displays on the screen, see [Chapter 7.6.2, "User Interface Tab"](#), on page 143.

Note: The softkey bar is hidden while the SmartGrid is displayed and restored automatically when the SmartGrid is closed.

Remote command:

`DISPlay:SKEYs[:STATe]` on page 563

Channel Bar

The channel setup bar provides information on firmware and measurement settings for a specific channel setup.

Remote command:

`DISPlay:ANNotation:CBAR` on page 562

Diagram Footer (Annotation)

The diagram footer beneath the diagram contains information on the x-axis of the diagram display, such as:

- The current center frequency and span settings
- The displayed span per division
- The number of sweep points

Remote command:

`DISPlay:ANNotation:FREQuency` on page 562

Date and Time

The date and time display can be switched off independently of the status bar.

You can set the current date and time and configure the display format in the "General" tab of the "Display" dialog box.

Remote command:

`DISPlay[:WINDow<n>]:TIME` on page 563

Front Panel

The "Front Panel" display simulates the entire front panel of the device (except for the external connectors) on the screen. Thus, you can interact with the R&S ZNL/ZNLE without the keypad and keys on the front panel of the device. That is useful, for example, when working with an external monitor or operating via remote control from a computer.

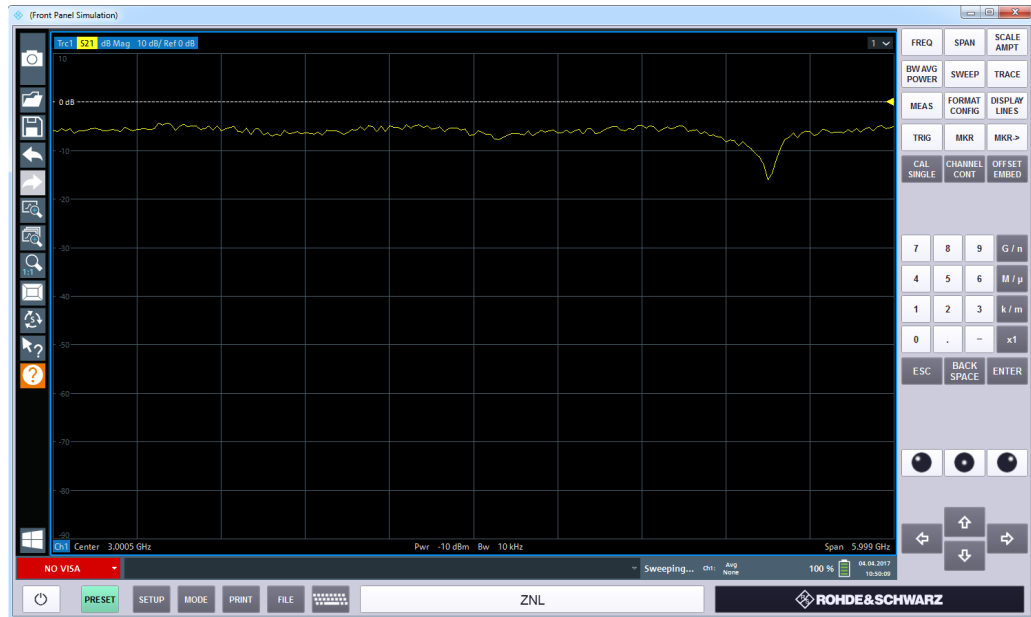

To activate or deactivate the front panel temporarily, press the [F6] key on the external keyboard (if available) or the remote computer.

For more information, see [Chapter 7.2.2, "How to Work with the Soft Front Panels"](#), on page 128.

Remote command:

`SYSTem:DISPlay:FPANel[:STATe]` on page 564

Mini Front Panel

If you require a front panel display but do not want to lose too much space for results in the display area, a mini front panel is available. The mini version displays only the main function keys in a separate window in the display area.

**Note:**

You can also activate the mini front panel using the key combination [ALT + m] (be aware of the keyboard language defined in the operating system!). That is useful when you are working from a remote PC and the front panel function is not active.

Remote command:

[SYSTem:DISPlay:FPANel\[:STATe\]](#) on page 564

7.2.1.3 Display Theme and Colors

Access: [Setup] > "Display" > "Theme + Color"

You can configure the used colors and styles of display elements on the screen.

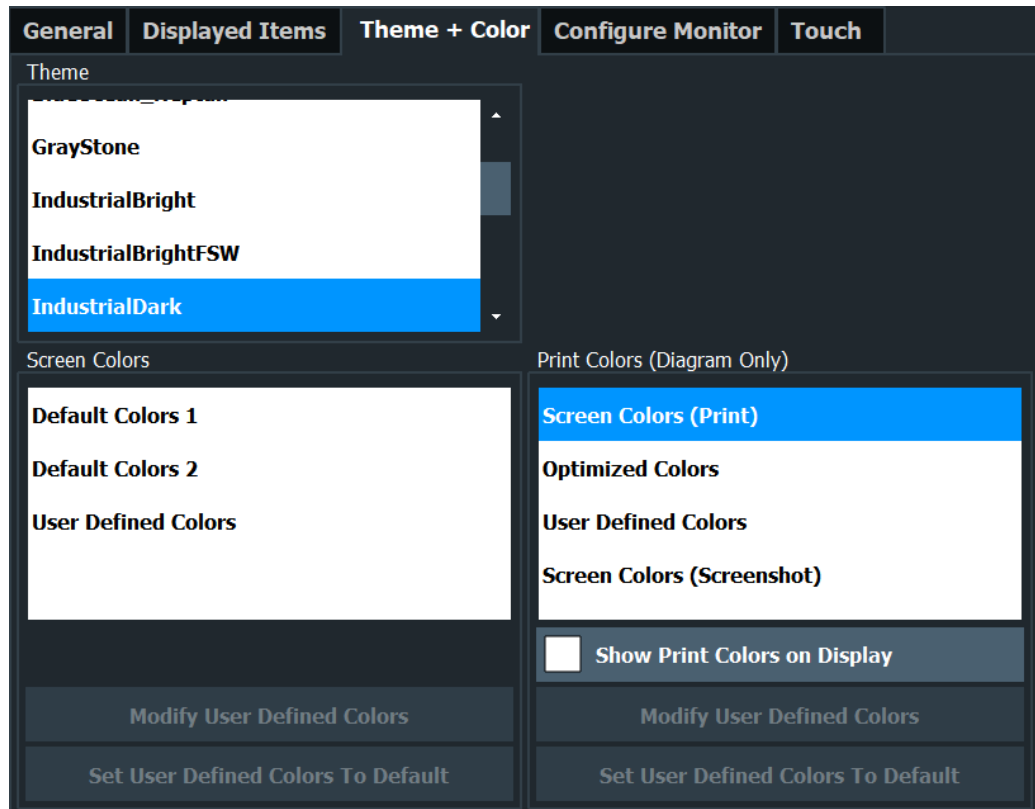

Theme.....	126
Print Colors.....	126
Showing Print Colors on Display.....	127

Theme

The theme defines the colors and style used to display softkeys and other screen objects.

The default theme is "IndustrialDark".

Remote command:

[DISPlay:THEMe:SElect](#) on page 566

Print Colors

Defines the color settings used for printout.

If "Show Print Colors on Display" is activated, the currently selected print colors are displayed as a preview for your selection.

Gui setting	Description	Remote command
"Optimized Colors"	Selects an optimized color setting for the printout to improve the visibility of the colors (default setting). Trace 1 is blue, trace 2 black, trace 3 green, and the markers are turquoise. The background is always printed in white and the grid in black.	HCOP:CMAP:DEF2
"Screen Colors (Print)"	Selects the current screen colors for the printout. The background is always printed in white and the grid in black.	HCOP:CMAP:DEF1
"Screen Colors (Screenshot)"	Selects the current screen colors without any changes for a screenshot.	HCOP:CMAP:DEF4

Remote command:

[HCOPY:CMAP<it>:DEFault<ci>](#) on page 546

Showing Print Colors on Display

Temporarily shows the currently selected print colors on the screen display. This function can be used as a preview for printing.

7.2.1.4 External Monitor Settings

Access: [Setup] > "Display" > "Configure Monitor"

You can connect an external monitor (or projector) to the "DVI" connector on the instrument's rear panel.



Screen resolution and format

The touchscreen of the R&S ZNL/ZNLE is calibrated for a 16:10 format. If you connect a monitor or projector using a different format (e.g. 4:3), the calibration is not correct and the screen does not react to your touch actions properly.

The touchscreen has a screen resolution of 1280x800 pixels. Usually, the display of the external monitor is a duplicate of the instrument's monitor.

If you configure the external monitor to be used as the *only* display in the Windows configuration dialog box ("Show only on 2"), the maximum screen resolution of the monitor is used. In this case, you can maximize the R&S ZNL/ZNLE application window and see even more details. You cannot change the monitor's screen resolution via the standard Windows configuration dialog box.

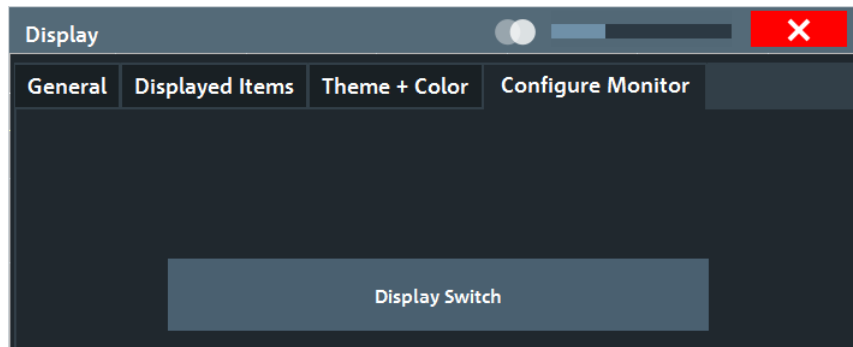

[Setup](#)..... 128

Setup

Opens the standard Windows configuration dialog box to configure the used display devices.

7.2.2 How to Work with the Soft Front Panels

Basic operation with the soft front panels is identical to normal operation, except for the following aspects:

To activate a key, select the key on the touchscreen.

To simulate the use of the rotary knob, use the additional keys displayed between the keypad and the arrow keys:

Icon	Function
●	Turn left
●	Enter
●	Turn right

Mini front panel

The mini front panel provides only the keys on the touchscreen, to operate the R&S ZNL/ZNLE via an external monitor or remote desktop.

By default, the "Auto close" option is activated and the mini front panel window closes automatically after you select a key. This is useful if you only require the mini front panel display occasionally to press a single function key.

If you want the window to remain open, deactivate the "Auto close" option. You can close the window manually by selecting "Close panel" or the key combination [ALT + M] (be aware of the keyboard language defined in the operating system!).

To display the soft front panel or mini front panel

1. Press the [Setup] key and select the "Display" softkey.
2. Select the "Displayed Items" tab.

3. Select "Front Panel": "On" or "Mini Front Panel": "On".



To activate or deactivate the front panel temporarily, press the [F6] key on the external keyboard (if available) or on the remote computer.

If the softkey menu is visible, you can display the "Mini Front Panel" quickly and easily by double-clicking the title of the softkey menu.

To close the mini front panel or the softkey menu, click the "Close" icon at the top of the menu or panel.

7.3 Language Settings

Access: [SETUP] > "Language"

The graphical user interface of the R&S ZNL/ZNLE can be displayed in various languages so you can operate the instrument in your most familiar language.

- ▶ Select the language from the list of available languages.

The software-defined interface elements (such as softkeys, dialog boxes, diagram texts etc.) are displayed in the selected language.

Remote command:

[SYSTem:DISPlay:LANGuage](#) on page 566

7.4 System Configuration Settings

Access: [Setup] > "System Configuration"

- [Hardware Information](#)..... 129
- [Information on Versions and Options](#)..... 130
- [System Messages](#)..... 132
- [Firmware Updates](#)..... 132
- [General Configuration Settings](#)..... 134
- [Additional Interfaces](#)..... 135

7.4.1 Hardware Information

Access: [Setup] > "System Configuration" > "Hardware Info"

An overview of the installed hardware in your R&S ZNL/ZNLE is provided.

Every listed component is described by its serial number, order number, model information, hardware code, and hardware revision.

This information can be useful when problems occur with the instrument and you require support from Rohde & Schwarz.

System Configuration						
Hardware Info	Versions + Options	System Messages	Firmware Update	Config		
COMPONENT	SERIAL #	ORDER #	MODEL	HWC	REV	
FRONTEND	100000	1304.0040	02	00	00.00	
MOTHERBOARD	100000	1323.0041	02	00	01.00	
OCXO	000000	1300.3180	00	00	00.00	
UNKNOWN						
CPU BOARD - SIM	234561/234	1234.5678				
DEFAULT IDENTITY						
NEPTUN DEVICE	100005	1319.2008	40			

Remote command:

[DIAGnostic:SERVice:HWInfo?](#) on page 571

7.4.2 Information on Versions and Options

Access: [Setup] > "System Configuration" > "Versions + Options"

Information on the firmware version and options installed on your instrument is provided. The unique Rohde & Schwarz device ID is also indicated here, as it is required for license and option administration.

You can also install new firmware options in this dialog box.

The table also contains:

- The open source acknowledgements (PDF file) for the firmware and other software packages used by the R&S ZNL/ZNLE
- The European License Agreement (EULA) for LucasFonts RSCorpid



Expired option licenses

If an option is about to expire, a message box is displayed to inform you. You can then use the "Install Option" function to enter a new license key.

If an option has already expired, a message box appears for you to confirm. In this case, all instrument functions are unavailable (including remote control) until the R&S ZNL/ZNLE is rebooted. You must then use the "Install Option" function to enter the new license key.

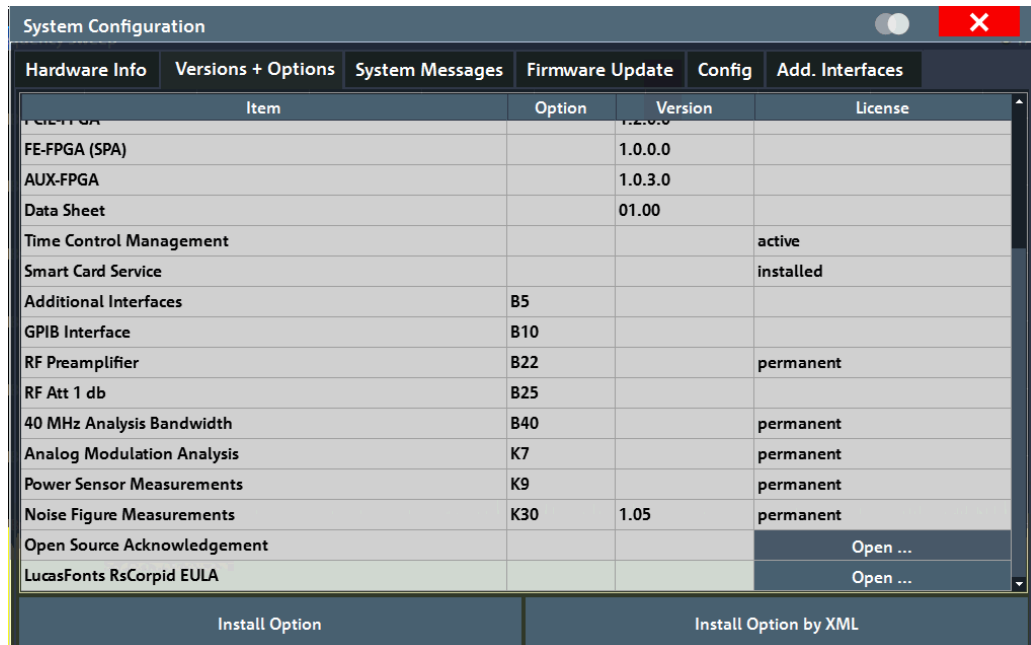

Item	Option	Version	License
FE-FPGA (SPA)		1.0.0.0	
AUX-FPGA		1.0.3.0	
Data Sheet		01.00	
Time Control Management			active
Smart Card Service			installed
Additional Interfaces	B5		
GPIB Interface	B10		
RF Pre-amplifier	B22		permanent
RF Att 1 db	B25		
40 MHz Analysis Bandwidth	B40		permanent
Analog Modulation Analysis	K7		permanent
Power Sensor Measurements	K9		permanent
Noise Figure Measurements	K30	1.05	permanent
Open Source Acknowledgement			Open ...
LucasFonts RsCorpid EULA			Open ...

Buttons at the bottom: Install Option, Install Option by XML

Remote commands:

[SYSTem:FORMat:IDENT](#) on page 573

[DIAGnostic:SERvice:BIOSinfo?](#) on page 571

[DIAGnostic:SERvice:VERSinfo?](#) on page 572

Open Source Acknowledgment: Open

Displays a PDF file containing information on open source code used by the R&S ZNL/ZNLE firmware.

LucasFonts RsCorpid EULA: Open

Displays a PDF file containing copyright information on the RsCorpid font used by the R&S ZNL/ZNLE firmware.

IVI Shared Components EULA: Open

Displays a PDF file containing copyright information on the IVI shared components used by the R&S ZNL/ZNLE firmware.

Install Option

Opens an edit dialog box to enter the license key for the option that you want to install.

Install Option by XML

Opens a file selection dialog box to install an additional option to the R&S ZNL/ZNLE using an XML file. Enter or browse for the name of an XML file that contains the option key and select "Select".

7.4.3 System Messages

Access: [Setup] > "System Configuration" > "System Messages"

The system messages generated by the R&S ZNL/ZNLE are displayed.

The messages are displayed in the order of their occurrence; the most recent messages are placed at the top of the list. Messages that have occurred since you last visited the system messages tab are marked with an asterisk '*'. *

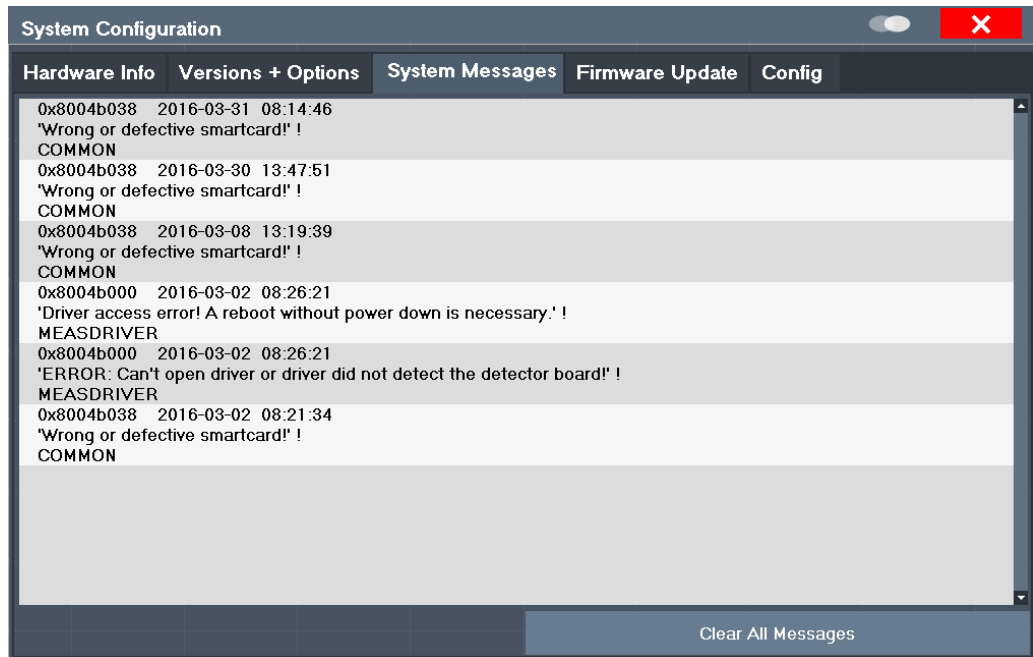

If the number of error messages exceeds the capacity of the error buffer, "Message Buffer Overflow" is displayed. To clear the message buffer use the "Clear All Messages" button.

The following information is available:

No	device-specific error code
Message	brief description of the message
Component	hardware messages: name of the affected module
	software messages: name of the affected software
Date/Time	date and time of the occurrence of the message

Remote command:

[SYSTem:ERRor:LIST?](#) on page 572

7.4.4 Firmware Updates

Access: [Setup] > "System Configuration" > "Firmware Update"

During instrument start, the installed hardware is checked against the current firmware version to ensure the hardware is supported. If not, an error message is displayed ("Wrong Firmware Version") and you are asked to update the firmware. Until the firmware version is updated, self-alignment fails. To see which components are not supported, see the [System Messages](#).

The firmware on your R&S ZNL/ZNLE may also need to be updated in order to enable additional new features or if reasons for improvement come up. Ask your sales representative or check the Rohde&Schwarz website for availability of firmware updates. A firmware update package includes at least a setup file and release notes.



Administrator Rights

By default, Windows® User Account Control is enabled on the instrument to prevent unwanted system-wide changes. Hence you need administrator rights to install a new firmware version. Refer to the Getting Started manual for details.

NOTICE

Before the update

- Carefully read the release notes provided with the firmware.
- Do not perform the firmware update while a spectrum measurement is running (R&S ZNL only).
If a spectrum measurement is running, stop it by activating the corresponding tab, selecting the [Sweep] key and toggling the "Continuous Sweep" or "Single Sweep" softkey, whichever is highlighted.

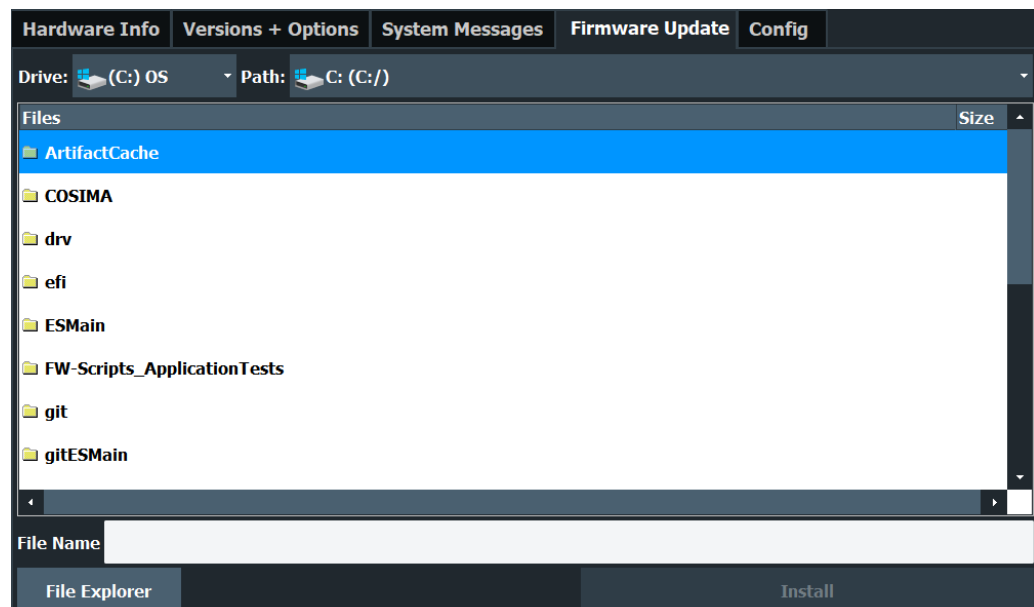

Enter the name or browse for the firmware installation file and press the "Install" button.

Remote command:

[SYSTem:FIRMware:UPDate](#) on page 573

How to Update the Instrument Firmware

1. Download the update package from the Rohde&Schwarz website and store it on a memory stick, on the instrument, or on a server network drive that can be accessed by the instrument.
2. Select the [Setup] key.
3. Select the "System Config" softkey.
4. Select the "Firmware Update" tab.
5. In the file selection dialog box select the ZNLSetup*.exe file.
"File Explorer": Instead of using the file manager of the R&S ZNL/ZNLE firmware, you can also use the Microsoft Windows File Explorer to manage files.
6. Select "Install" to start the update.
7. To start the firmware update, you need to pass a Windows User Account Control dialog. As a standard Windows user, you have to enter an administrator name and password. Select "Yes" to proceed.
8. After the firmware update, the R&S ZNL/ZNLE reboots automatically.
9. Depending on the previous firmware version, a reconfiguration of the hardware might be required during the first startup of the firmware. The reconfiguration starts automatically, and a message box informs you about the process. When the reconfiguration has finished, the instrument again reboots automatically.

Note: Do not switch off the instrument during the reconfiguration process!

Now the firmware update is complete.

7.4.5 General Configuration Settings

Access: [Setup] > "System Configuration" > "Config"

General system settings, for example concerning the initial behaviour of the R&S ZNL/ZNLE after booting, can also be configured.

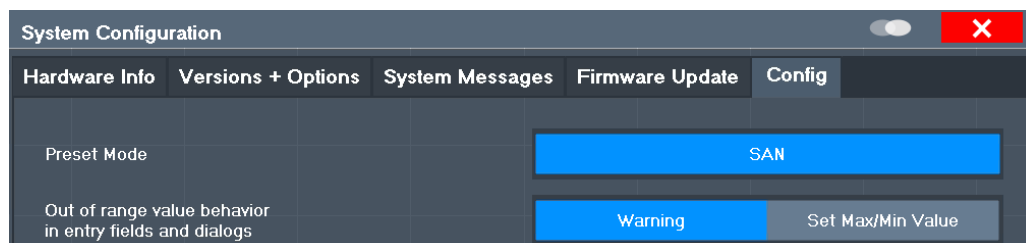

Preset Mode	135
Out-of-range value behavior	135

Preset Mode

The presettings can be defined in the "Config" tab of the "System Configuration" dialog box.

For details on operating modes see [Chapter 5, "Operating Modes, Applications, Channel Setups, and Result Displays"](#), on page 85.

"SAN" Signal and Spectrum Analyzer mode
(Only when the optional Spectrum application has been installed.)

"VNA" Vector Network Analysis

Remote command:

`SYSTem:PRESet:COMPAtible` on page 574

Out-of-range value behavior

By default, if you enter a value that is outside the valid range in an input field for a setting, a warning is displayed and the value is not accepted. Alternatively, entries below the minimum value can automatically be set to the minimum possible entry, and entries above the maximum value set to the maximum possible entry. This behavior avoids errors and facilitates setting correct values.

7.4.6 Additional Interfaces

The following settings are only available if the "Additional interfaces" option R&S FPL1-B5 is installed.

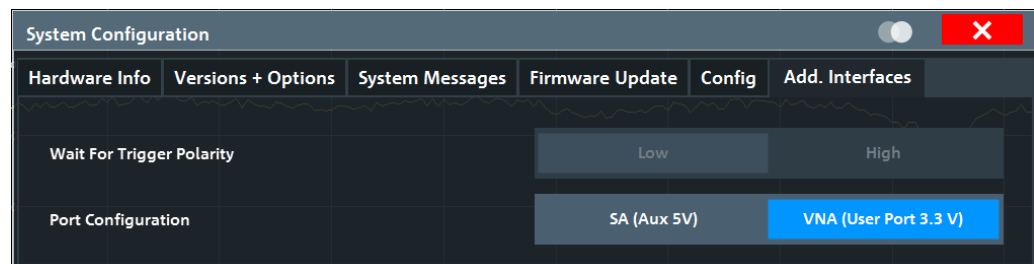

These options are not available for the R&S ZNLE.

**Wait for Trigger Polarity**

In Spectrum operating mode, the optional AUX PORT connector of the R&S ZNL can provide a signal that indicates the instrument is ready to receive a trigger signal.

(For details on the connector see the R&S ZNL Getting Started manual).

The signal polarity that indicates the trigger availability is configurable.

"Low" A low signal (= 0 V) indicates the instrument is ready to receive a trigger.

"High" A high signal (= 5 V) indicates the instrument is ready to receive a trigger.

Port Configuration

The Additional Interfaces provided by option R&S FPL1-B5 can either be used by SA channel setups (SA mode) or by VNA channel setups (VNA mode, default).

"SA (Aux 5 V)" The Additional Interfaces can only be used by SA channel setups. In particular the Aux. Port is configured as SA Auxiliary Port (5 V). In this mode, VNA channel setups can not use the VNA User Port functionality (trigger, channel bits, TTL signals, ...).

"VNA (User Port 3.3 V)" VNA channel setups can use the Aux. Port as VNA User Port (3.3 V). For details on the connector see [Chapter 15.3.1.1, "Aux. Port"](#), on page 1014. In this mode, SA channel setups can't use **any** of the Additional Interfaces.

Remote command:
n.a.

7.5 Service Functions

Access: [Setup] > "Service"

When unexpected problems arise with the R&S ZNL/ZNLE some service functions may help you solve them.

For more helpful information for support, see also [Chapter 12.3, "Collecting Information for Support"](#), on page 1006

- [R&S Support Information](#)..... 136
- [Self-test Settings and Results](#)..... 138
- [Calibration Signal Display](#)..... 138
- [Service Functions](#)..... 140

7.5.1 R&S Support Information

Access: [Setup] > "Service" > "R&S Support"

In case of errors you can store useful information for troubleshooting and send it to your Rohde & Schwarz support center.

Service														
R&S Support	Selftest	Calibration Signal	Service Function	Hardware Diagnostics										
Create R&S Support Information		Location: C:/ES-MAIN/etv/SW/user/												
In case of problems, please write an email with the error description, attach the Support Information file and send the email to the Rohde&Schwarz Support Center.														
Save Device Footprint		Location: C:/ES-MAIN/etv/SW/devicedata/XML/												
Contact Information														
<table border="1"> <tr> <td>Customer Support Europe, Africa, Middle East:</td> <td>Phone#0095ff 4129 12345 customersupport@rohde-schwarz.com</td> </tr> <tr> <td>Customer Support North America:</td> <td>Phone#0095ffTEST-RSA (1-888-837-8772) customer.support@rsa.rohde-schwarz.com</td> </tr> <tr> <td>Customer Support Latin America:</td> <td>Phone#0095ff-910-7988 customersupport.la@rohde-schwarz.com</td> </tr> <tr> <td>Customer Support Asia/Pacific:</td> <td>Phone#0095ff 13 04 88 customersupport.asia@rohde-schwarz.com</td> </tr> <tr> <td>Customer Support China:</td> <td>Phone#0095ff0-810-8228 / +86-400-650-5896 customersupport.china@rohde-schwarz.com</td> </tr> </table>					Customer Support Europe, Africa, Middle East:	Phone#0095ff 4129 12345 customersupport@rohde-schwarz.com	Customer Support North America:	Phone#0095ffTEST-RSA (1-888-837-8772) customer.support@rsa.rohde-schwarz.com	Customer Support Latin America:	Phone#0095ff-910-7988 customersupport.la@rohde-schwarz.com	Customer Support Asia/Pacific:	Phone#0095ff 13 04 88 customersupport.asia@rohde-schwarz.com	Customer Support China:	Phone#0095ff0-810-8228 / +86-400-650-5896 customersupport.china@rohde-schwarz.com
Customer Support Europe, Africa, Middle East:	Phone#0095ff 4129 12345 customersupport@rohde-schwarz.com													
Customer Support North America:	Phone#0095ffTEST-RSA (1-888-837-8772) customer.support@rsa.rohde-schwarz.com													
Customer Support Latin America:	Phone#0095ff-910-7988 customersupport.la@rohde-schwarz.com													
Customer Support Asia/Pacific:	Phone#0095ff 13 04 88 customersupport.asia@rohde-schwarz.com													
Customer Support China:	Phone#0095ff0-810-8228 / +86-400-650-5896 customersupport.china@rohde-schwarz.com													

[Create R&S Support Information](#) 137

[Save Device Footprint](#)..... 137

Create R&S Support Information

Creates a *.zip file with important support information. The *.zip file contains the system configuration information ("Device Footprint"), the current eeprom data and a screenshot of the screen display.

This data is stored to the C:\ProgramData\Rohde-Schwarz\ZNL-FPL directory on the instrument.

The file name consists of the unique device ID and the current date and time of the file creation.

If you contact the Rohde & Schwarz support to get help for a certain problem, send these files to the support in order to identify and solve the problem faster.

Remote command:

[DIAGnostic:SERVice:SINFo?](#) on page 575

Save Device Footprint

Creates an *.xml file with information on installed hardware, software, image and FPGA versions. The *.xml file is stored under

C:\Program Files\Rohde-Schwarz\Vector Network Analyzer\ZNL\devicedata\xml\ on the instrument. It is also included in the service ZIP file (see "[Create R&S Support Information](#)" on page 137).

7.5.2 Self-test Settings and Results

Access: [Setup] > "Service" > "Selftest"

If the R&S ZNL/ZNLE fails you can perform a self-test of the instrument to identify any defective modules.

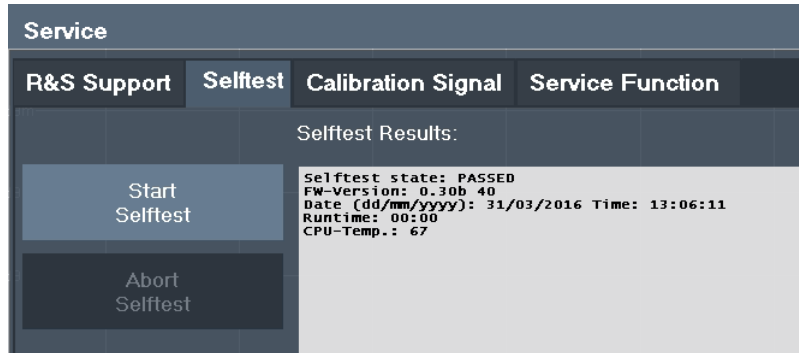

Once the self-test is started, all modules are checked consecutively and the test result is displayed. You can abort a running test.

In case of failure a short description of the failed test, the defective module, the associated value range and the corresponding test results are indicated.



A running Sequencer process is aborted when you start a self-test.

If you start a self-test remotely, then select the "Local" softkey while the test is still running, the instrument only returns to the manual operation state after the test is completed. In this case, the self-test cannot be aborted.

Remote command:

[*TST?](#) on page 524

[DIAGnostic:SERVice:STESt:RESult?](#) on page 560

7.5.3 Calibration Signal Display

Access: [Setup] > "Service" > "Calibration Signal"

Alternatively to the RF input signal from the front panel connector you can use the instrument's calibration signal as the input signal, for example to perform service functions on.

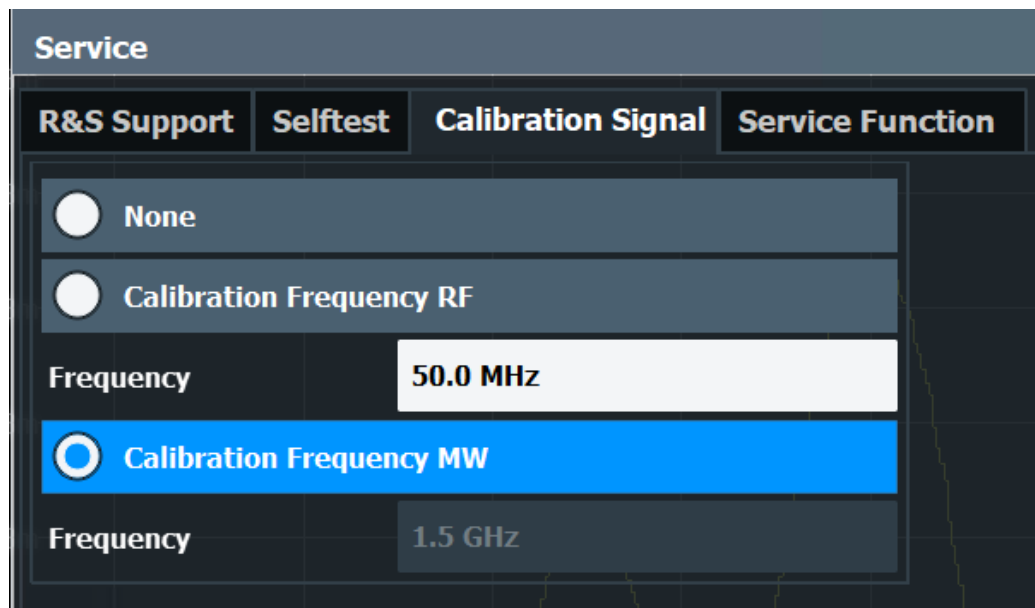

NONE	139
Calibration Frequency RF.....	139
└ Frequency.....	139
Calibration Frequency MW.....	139

NONE

Uses the current RF signal at the input, i.e. no calibration signal (default).

Remote command:

[DIAGnostic:SERVice:INPut\[:SElect\]](#) on page 560

Calibration Frequency RF

Uses the internal calibration signal as the RF input signal.

Remote command:

[DIAGnostic:SERVice:INPut\[:SElect\]](#) on page 560

[DIAGnostic:SERVice:INPut:PULSed:CFrequency](#) on page 559

Frequency ← Calibration Frequency RF

Defines the frequency of the internal broadband calibration signal to be used for IF filter calibration (max. 64 MHz).

Calibration Frequency MW

Uses the microwave calibration signal as the RF input. This function is used to calibrate the YIG-filter on the microwave converter. The microwave calibration signal is pulsed. The microwave calibration signal frequency is fixed at 1.5 GHz.

Remote command:

[DIAGnostic:SERVice:INPut\[:SElect\]](#) on page 560

7.5.4 Service Functions

Access: [Setup] > "Service" > "Service Function"

NOTICE

Using service functions

The service functions are not necessary for normal measurement operation. Incorrect use can affect correct operation and/or data integrity of the R&S ZNL/ZNLE.

Therefore, many of the functions can only be used after entering a password. These functions are described in the instrument service manual.

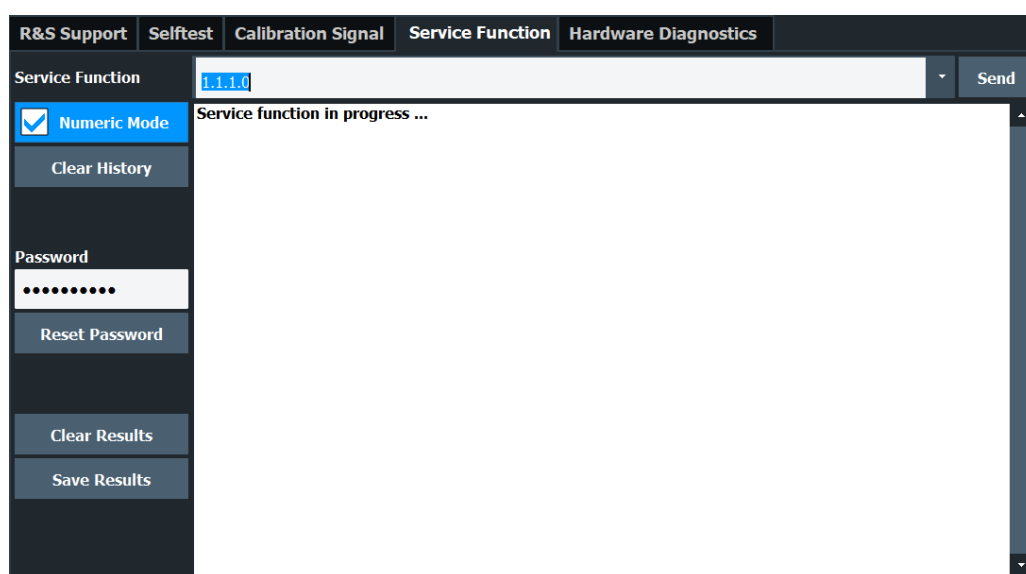

Service Function.....	140
Send	140
Clear History.....	141
Password.....	141
Clear Results.....	141
Save Results.....	141
Result list.....	141

Service Function

Selects the service function by its numeric code or textual name.

The selection list includes all functions previously selected (since the last "Clear History" action).

Remote command:

`DIAGnostic:SERvice:SFUNction` on page 574

Send

Starts the selected service function.

Remote command:

[DIAGnostic:SERvice:SFUNction](#) on page 574

Clear History

Deletes the list of previously selected service functions.

Password

Most service functions require a special password as they may disrupt normal operation of the R&S ZNL/ZNLE. There are different levels of service functions, depending on how restrictive their use is handled. Each service level has a different password.

"Reset Password" clears any previously entered password and returns to the most restrictive service level.

Remote command:

[SYSTem:PASSword\[:CENable\]](#) on page 576

[SYSTem:PASSword:RESet](#) on page 576

Clear Results

Clears the result display for all previously performed service functions.

Remote command:

[DIAGnostic:SERvice:SFUNction:RESults:DELeTe](#) on page 575

Save Results

Opens a file selection dialog box to save the results of all previously performed service functions to a file.

Remote command:

[DIAGnostic:SERvice:SFUNction:RESults:SAVE](#) on page 575

Result list

The Results List indicates the status and results of the executed service functions.

7.6 VNA Setup

The VNA Setup dialog offers instrument settings that are only relevant for the VNA mode.

- [Calibration Tab](#)..... 141
- [User Interface Tab](#)..... 143
- [Advanced Tab](#)..... 145
- [Power Tab](#)..... 146

7.6.1 Calibration Tab

Provides general system error correction (calibration) settings.

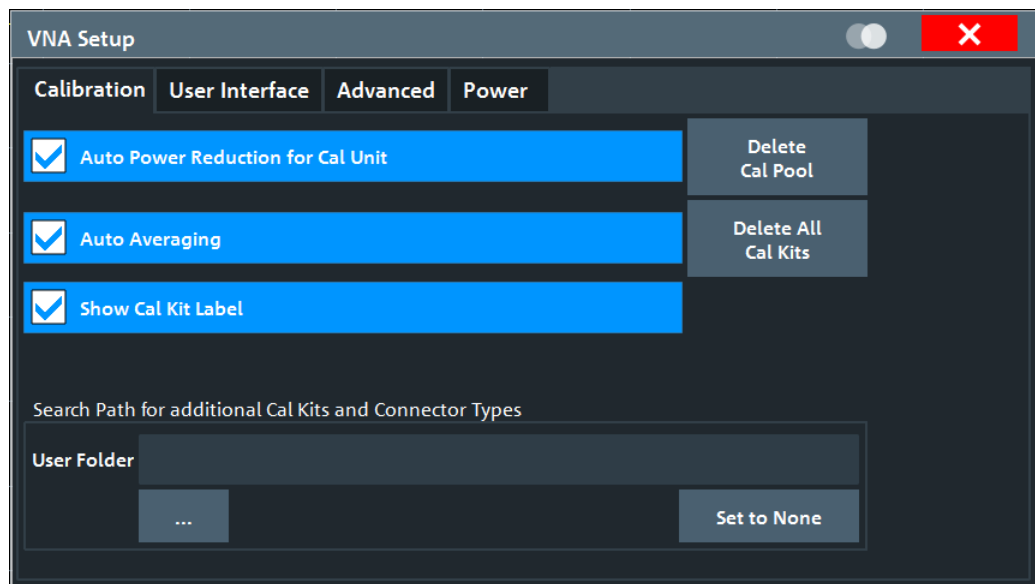

Auto Power Setting for Cal Unit

Sets the source power at all test ports to -10 dBm while an automatic calibration is active. Applying this source power to the ports of the calibration unit ensures best accuracy of the automatic calibration. The source powers are reset to their original values after the calibration is completed. The automatic power reduction can be deactivated in case that the test setup introduces a large attenuation.

Remote command:

```
SYSTem:COMMunicate:RDEvice:AKAL:PREduction[:STATe]
```

Auto Averaging

Activates automatic averaging, which means that the VNA performs multiple calibration sweeps and applies averaging to reduce trace noise. In contrast to regular averaging (see [Chapter 10.4.3, "Average Tab"](#), on page 308), the number of calibration sweeps is calculated automatically.

Remote command:

```
[SENSe:]CORRection:COLLect:AVERAge
```

Show Cal Kit Label

Enables/disables the "Calibration Info" dialog during manual calibration (see ["Start Cal Sweep"](#) on page 465).

Independent of the state of the "Show Cal Kit Label" flag, cal kit labels are displayed in several other manual calibration dialogs.

Delete Cal Pool / Delete All Cal Kits

Deletes all calibration data and all cal kit data. See [Chapter 10.12.3.2, "Calibration Manager Dialog"](#), on page 481.

Remote command:

n/a

Search Path for additional Cal Kits and Connector Types

Contains the name and path of a special directory for cal kit files (*.calkit). All cal kit files in the special directory are loaded automatically as predefined kits (i.e. read-only kits which cannot be modified) every time the VNA application is started. It is possible to select the default cal kit directory

C:\Users\Public\Documents\Rohde-Schwarz\ZNL\Calibration\Kits or any other directory. "None" means that no additional cal kit files are loaded on start-up.

Use the special directory to make sure that you do not have to import kits manually, even after terminating the VNA application improperly. In this case, previously imported cal kit files are not stored in the channel setup file.

Remote command:

MMEMory:LOAD:CKIT:UDIRectory

7.6.2 User Interface Tab

Provides general user interface configurations.

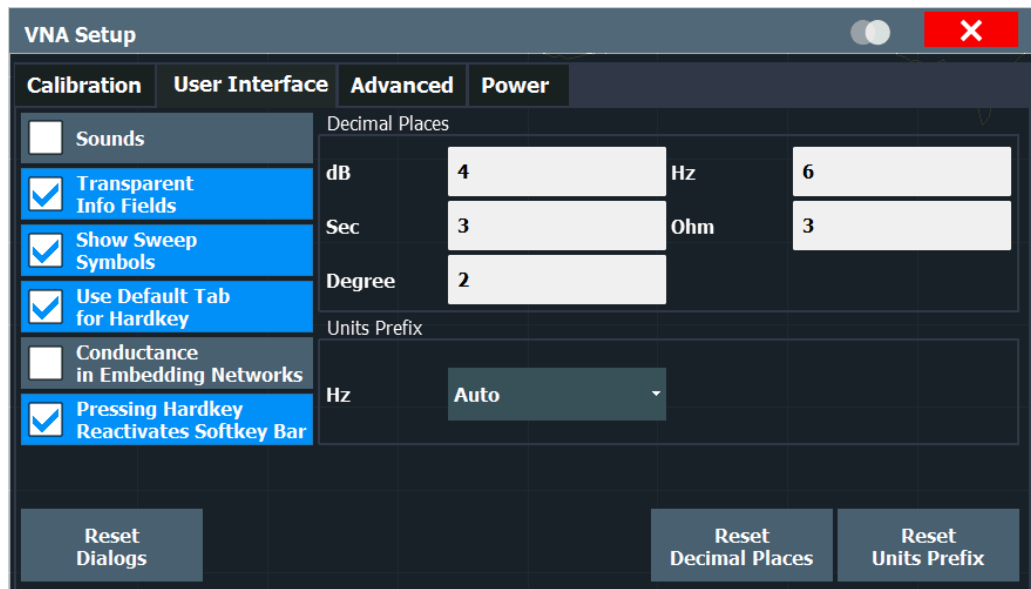

Sounds

Switches the sounds generated by the analyzer GUI on or off. Sounds are generated for certain GUI events, when the analyzer generates a notice, status or warning message (alarm sounds) or during calibration.

Limit fail beeps for [limit tests](#), [ripple tests](#), and [circle tests](#) is not affected by this setting. If enabled, those beeps are generated even if "Sounds" is unchecked.

Note: The R&S ZNL/ZNLE does not have a built-in audio device and loudspeaker. To hear these sounds, connect a USB audio device to the instrument or operate it via remote desktop.

Transparent Info Fields

This checkbox enables or disables transparent info fields for markers and trace statistics.

Transparent info fields do not hide an underlying trace.

Remote command:

n.a.

Show Sweep Symbols

This checkbox turns sweep symbols on or off.

Sweep symbols are arrows pointing downward onto the trace. They are displayed if the sweep time exceeds an upper limit, e.g. if the number of points is high or the measurement bandwidth is low.

Remote command:

n.a.

Use Default Tab for Hardkey

If the checkbox is selected (system default), the [Function Keys](#) activate the first enabled tab of their associated softtool. Otherwise the last used tab is activated.

For background information, see [Chapter 10.1, "Function Keys and Softtools"](#), on page 294.

Remote command:

n/a

Conductance in Embedding Networks

Changes the presentation of "capacitance C<i> in parallel with resistance R<i>" circuit blocks in lumped de/embedding networks (see [Chapter 9.6.2.3, "Circuit Models for 2-Port Networks"](#), on page 273 and [Chapter 9.6.2.4, "Circuit Models for 4-Port Networks"](#), on page 274).

If active, the resistance R<i> is displayed and specified as conductance G<i> ($=1/R<i>$).

Remote command:

`SYSTEM:DISPLAY:CONDUCTANCES`n/a

Pressing Hardkey Reactivates Softkey Bar

If the checkbox is selected (default), then pressing a function key displays the related softtool and keeps the softkey bar open. Otherwise, if the softkey bar is hidden, it appears only for a few seconds.

The softkey bar can be hidden using its close button or via display settings (see [Chapter 7.2.1.2, "Displayed Items"](#), on page 122).

Decimal Places

Defines the number of fractional digits for quantities with different physical units. The settings affect entries and results, e.g. the values in the marker lists.

Remote command:

n/a

Units Prefix

Sets the unit prefix for frequencies (Base unit: Hz) to kilo (k), mega (M), giga (G) or tera (T) or lets the R&S ZNL/ZNLE select the appropriate prefix ("Auto" = default setting).

Remote command:
n/a

Reset Dialogs / Reset Decimal Places / Reset Units Prefix

Resets the dialog properties, the "Decimal Places" and the "Units Prefix" settings. These settings are global and not affected by an instrument preset.

Note: Color settings are configured in [Chapter 7.2.1.3, "Display Theme and Colors"](#), on page 125.

Remote command:
n/a

7.6.3 Advanced Tab

Collects several advanced settings.

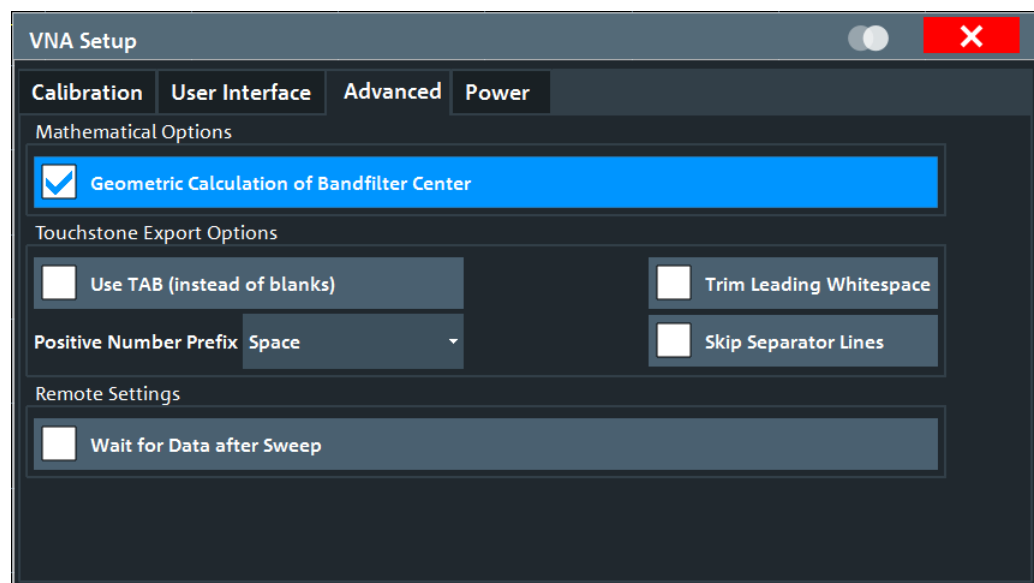
**Geometric Calculation of Bandfilter Center**

Defines how bandfilter searches calculate the center frequency of the passband or stopband (see "[Bandfilter Search](#)" on page 204).

If "Geometric Calculation of Bandfilter Center" is checked, the *geometric mean* of the lower band edge and upper band edge frequencies is used, otherwise their *arithmetic mean*.

Remote command:
`CALCulate:MARKer:FUNction:BWIDth:GMCenter`

Touchstone Export Options

Configures whitespace insertion during legacy [Version 1.1 \(ZNx\)](#) Touchstone file export.

The default export format is explained in [Chapter 9.4.2.1, "Touchstone Files"](#), on page 239:

- logical columns are vertically aligned using spaces
- positive and negative numbers are vertically aligned by prefixing positive numbers with blanks
- the frequencies are horizontally separated from the corresponding S matrices using leading spaces
- the content parts (header, S matrices for different frequencies) are separated by blank lines

Use TAB (instead of blanks) ← Touchstone Export Options

If checked, columns are separated by tabs rather than spaces.

Remote command:

```
MMEMory:STORe:TRACe:OPTion:TABS
```

Trim Leading Whitespace ← Touchstone Export Options

If checked, whitespace at the beginning of each line is removed.

Remote command:

```
MMEMory:STORe:TRACe:OPTion:TRIM
```

Positive Number Prefix ← Touchstone Export Options

Positive numbers can either be prefixed by blanks, by plus signs or not at all.

Remote command:

```
MMEMory:STORe:TRACe:OPTion:PLUS
```

Skip Separator Lines ← Touchstone Export Options

If checked, the content parts are no longer separated by blank lines.

Remote command:

```
MMEMory:STORe:TRACe:OPTion:SSEParator
```

Remote Settings: Wait for Data after Sweep

Determines the execution behavior of `INITiate[:IMMEDIATE]` commands (see [Chapter 11.5.2.7, "INITiate Commands"](#), on page 779).

If enabled, an automatic `*WAI` is added. Disabled by default.

Remote command:

```
SYSTem:COMMunicate:GPIB[:SELF]:INIT:WAIT
```

7.6.4 Power Tab

The settings in this tab define global power settings of the VNA.

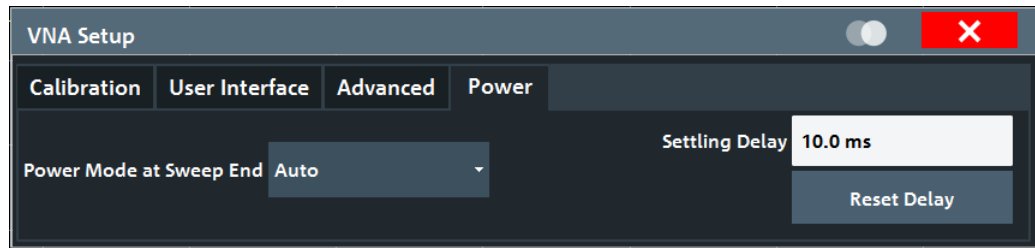

Power Reduction at Sweep End

The power reduction settings apply to all sweep modes but are particularly useful in single sweep mode.

Power Mode at Sweep End ← Power Reduction at Sweep End

The analyzer offers three power modes at sweep end:

- "Auto" results in the shortest measurement time (default setting). If enabled, at sweep end the output power of the first measurement point is restored. The configured [Settling Delay](#) is not applied.
- "Reduce" is intended for measurements on sensitive DUTs. If enabled, at sweep end the output power of the driving port is reduced as if the channel base power was set to its minimum possible value. The configured settling delay is applied.
- If "Keep" is enabled, at sweep end the output power of the last measurement point is kept. The configured settling delay is applied.

Note:

- Compared to "Auto" mode, "Reduce" and "Keep" can result in significantly longer measurement times - in particular if an extended settling delay is used.
- The output power is not altered if there is only a single channel with a single driving port, performing a "Time" or "CW Mode" sweep.
- In triggered mode, the analyzer always uses the settings of the first measurement point while waiting for the trigger signal.

Remote command:

`SOURce:POWer:SWEepend:MODE`

Settling Delay / Reset Delay ← Power Reduction at Sweep End

If [Power Mode at Sweep End](#) is set to "Reduce" or "Keep", the "Settling Delay" defines the time between [Restart Sweep](#) request and sweep start.

Use the "Reset Delay" button to adjust the "Settling Delay" to its default value.

Remote command:

`SOURce:POWer:SWEepend:SDELay`

7.7 Toolbar Configuration

If the list of available icons becomes longer than the height of the screen, an arrow at the bottom of the toolbar indicates that further icons are available.

However, you can configure which icons are displayed in the toolbar, and in which order.



Toolbar configuration is saved when you shut down or preset the R&S ZNL/ZNLE. It is not included in save sets (see [Chapter 6.2, "Storing and Recalling Instrument Settings and Measurement Data"](#), on page 96).

To configure the toolbar

1. From the toolbar, select "More icons" > "Edit Toolbar".
The toolbar is highlighted red to indicate it is in edit mode.
2. Drag and drop the icons in the toolbar to the required position. A blue line indicates the selected position.

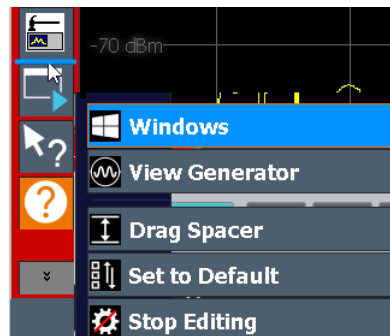



Figure 7-1: Inserting the Windows icon in the toolbar

3. To add an icon that is currently not visible:
 - a) Select "More icons".
All hidden icons are displayed in a menu.
 - b) Drag the icon from the menu to the toolbar.
The added icon is displayed. If the toolbar contains too many icons to display, the icons from the bottom move to the menu.
4. To hide an icon from the toolbar, drag and drop it outside the toolbar.
The icon is moved to the menu of hidden icons ("More icons"). Empty spaces are indicated by a spacer.
 
5. To insert additional spaces between icons, for example to create groups of icons:
 - a) Select "More icons" > "Drag Spacer".
 - b) Drag and drop the "Drag Spacer" at the required position in the toolbar. Multiple spaces can be inserted.
6. To restore the default R&S ZNL/ZNLE toolbar, select "More icons" > "Set to Default".
7. To exit the toolbar edit mode, select "More icons" > "Stop Editing".
The red highlighting is removed. Selecting an icon performs the assigned function as usual.

8 Network and Remote Settings

In addition to working with the R&S ZNL/ZNLE interactively, located directly at the instrument, it is also possible to operate and control it from a remote PC. Various methods for remote control are supported:

- Connecting the instrument to a (LAN) network
- Using the web browser interface in a LAN network
- Using the Windows Remote Desktop application in a LAN network
- Connecting a PC via the GPIB interface

How to configure the remote control interfaces is described in [Chapter 8.5, "How to Set Up a Network and Remote Control"](#), on page 166.

- [Remote Control Interfaces and Protocols](#)..... 149
- [SCPI \(Standard Commands for Programmable Instruments\)](#)..... 156
- [VISA Libraries](#)..... 156
- [Network and Remote Control Settings](#)..... 156
- [How to Set Up a Network and Remote Control](#)..... 166

8.1 Remote Control Interfaces and Protocols

The instrument supports different interfaces and protocols for remote control. The following table gives an overview.

Table 8-1: Remote control interfaces and protocols

Interface	Protocols, VISA ^{*)} address string	Remarks
Local Area Network (LAN)	<ul style="list-style-type: none"> • HiSLIP High-Speed LAN Instrument Protocol (IVI-6.1) TCP/IP::host address::hislip0[::INSTR] • VXI-11 TCP/IP::host address::inst0[::INSTR] Library: VISA • socket communication (Raw Ethernet, simple Telnet) TCP/IP::host address[::LAN device name]::<port>::SOCKET Library: VISA or socket controller 	<p>A LAN connector is located on the rear panel of the instrument.</p> <p>The interface is based on TCP/IP and supports various protocols.</p> <p>For a description of the protocols refer to:</p> <ul style="list-style-type: none"> 8.1.1.1 VXI-11 Protocol 8.1.1.2 HiSLIP Protocol 8.1.1.3 Socket Communication
GPIB (IEC/IEEE Bus Interface)	<p>VISA^{*)} address string:</p> <p>GPIB::primary address[::INSTR] (no secondary address)</p>	<p>An optional GPIB bus interface according to the IEC 625.1/IEEE 488.1 standard is located on the rear panel of the instrument.</p> <p>For a description of the interface refer to 8.1.2 GPIB Interface (IEC 625/IEEE 418 Bus Interface).</p>
<p>^{*)} VISA is a standardized software interface library providing input and output functions to communicate with instruments. A VISA installation on the controller is a prerequisite for remote control using the indicated interfaces. (See also Chapter 8.3, "VISA Libraries", on page 156).</p>		



Within this interface description, the term GPIB is used as a synonym for the IEC/IEEE bus interface.

8.1.1 LAN Interface

To be integrated in a LAN, the instrument is equipped with a LAN interface, consisting of a connector, a network interface card and protocols. The network card can be operated with the following interfaces:

- 10 Mbit/s Ethernet IEEE 802.3
- 100 Mbit/s Ethernet IEEE 802.3u
- 1Gbit/s Ethernet IEEE 802.3ab

For remote control via a network, the PC and the instrument must be connected via the LAN interface to a common network with TCP/IP network protocol. They are connected using a commercial RJ45 cable (shielded or unshielded twisted pair category 5). The TCP/IP network protocol and the associated network services are preconfigured on the instrument. Software for instrument control and the VISA program library must be installed on the controller.

VISA library

Instrument access is usually achieved from high level programming platforms using VISA as an intermediate abstraction layer. VISA encapsulates the low level VXI, GPIB, LAN or USB function calls and thus makes the transport interface transparent for the user. See [Chapter 8.3, "VISA Libraries"](#), on page 156 for details.

The R&S ZNL/ZNLE supports various LAN protocols such as VXI11, RSIB, raw socket or the newer HiSLIP protocol.

IP address

Only the IP address or a valid DNS host name is required to set up the connection. The host address is part of the "VISA resource string" used by the programs to identify and control the instrument.

The VISA resource string has the form:

```
TCPIP::host address[::LAN device name][::INSTR]
```

or

```
TCPIP::host address::port::SOCKET
```

where:

- **TCPIP** designates the network protocol used
- **host address** is the IP address or host name of the device
- **LAN device name** defines the protocol and the instance number of a subinstrument;
 - `inst0` selects the VXI-11 protocol (default)

- `hislip0` selects the newer HiSLIP protocol
- **INSTR** indicates the instrument resource class (optional)
- **port** determines the used port number
- **SOCKET** indicates the raw network socket resource class

Example:

- Instrument has the IP address `192.1.2.3`; the valid resource string using VXI-11 protocol is:
`TCPIP::192.1.2.3::INSTR`
- The DNS host name is `ZNL3-123456`; the valid resource string using HiSLIP is:
`TCPIP::ZNL3-123456::hislip0`
- A raw socket connection can be established using:
`TCPIP::192.1.2.3::5025::SOCKET`

**Identifying instruments in a network**

If several instruments are connected to the network, each instrument has its own IP address and associated resource string. The controller identifies these instruments by the resource string.

For details on configuring the LAN connection, see [Chapter 8.5.1, "How to Configure a Network"](#), on page 166.

- [VXI-11 Protocol](#)..... 151
- [HiSLIP Protocol](#)..... 151
- [Socket Communication](#)..... 152
- [LAN Web Browser Interface](#)..... 152

8.1.1.1 VXI-11 Protocol

The VXI-11 standard is based on the ONC RPC (Open Network Computing Remote Procedure Call) protocol which in turn relies on TCP/IP as the network/transport layer. The TCP/IP network protocol and the associated network services are preconfigured. TCP/IP ensures connection-oriented communication, where the order of the exchanged messages is adhered to and interrupted links are identified. With this protocol, messages cannot be lost.

8.1.1.2 HiSLIP Protocol

The High Speed LAN Instrument Protocol (HiSLIP) is the successor protocol for VXI-11 for TCP-based instruments specified by the IVI foundation. The protocol uses two TCP sockets for a single connection - one for fast data transfer, the other for non-sequential control commands (e.g. `Device Clear` or `SRQ`).

HiSLIP has the following characteristics:

- High performance as with raw socket network connections
- Compatible IEEE 488.2 support for Message Exchange Protocol, Device Clear, Serial Poll, Remote/Local, Trigger, and Service Request

- Uses a single IANA registered port (4880), which simplifies the configuration of firewalls
- Supports simultaneous access of multiple users by providing versatile locking mechanisms
- Usable for IPv6 or IPv4 networks



Using VXI-11, each operation is blocked until a VXI-11 instrument handshake returns. However, using HiSLIP, data is sent to the instrument using the "fire and forget" method with immediate return. Thus, a successful return of a VISA operation such as `viWrite()` guarantees only that the command is delivered to the instrument's TCP/IP buffers. There is no confirmation, that the instrument has started or finished the requested command.

For more information see also the application note:

[1MA208: Fast Remote Instrument Control with HiSLIP](#)

8.1.1.3 Socket Communication

An alternative way for remote control of the product is to establish a simple network communication using sockets. The socket communication, also referred to as "Raw Ethernet communication", does not necessarily require a VISA installation on the remote controller side. It is available by default on all operating systems.

The simplest way to establish socket communication is to use the built-in telnet program. The telnet program is part of every operating system and supports a communication with the software on a command-by-command basis. For more convenience and to enable automation by programs, user-defined sockets can be programmed.

Socket connections are established on a specially defined port. The socket address is a combination of the IP address or the host name of the instrument and the number of the port configured for remote-control. Typically, the products of Rohde & Schwarz use port number 5025 for this purpose. The port is configured for communication on a command-to-command basis and for remote control from a program.

8.1.1.4 LAN Web Browser Interface

The LAN web browser interface allows for easy configuration of the LAN and remote control of the R&S ZNL/ZNLE without additional installation requirements.

The instrument's LAN web browser interface works correctly with all W3C compliant browsers.

Via the web browser interface to the R&S ZNL/ZNLE you can control the instrument remotely from another PC. Manual instrument controls are available via the front panel simulation. File upload and download between the instrument and the remote PC is also available. Using this feature, several users can access *and operate* the R&S ZNL/ZNLE simultaneously. This is useful for troubleshooting or training purposes.

For details, see [Chapter 8.5.1.4, "How to Configure the LAN Using the Web Browser Interface"](#), on page 170 and [Chapter 8.5.5, "How to Control the R&S ZNL/ZNLE via the Web Browser Interface"](#), on page 176.



If you do not want other users in the LAN to be able to access and operate the R&S ZNL/ZNLE you can deactivate this function.

See [Chapter 8.5.6, "How to Deactivate the Web Browser Interface"](#), on page 177.

To display the LAN web browser interface

- ▶ In the address field of the browser on your PC, type the host name or IP address of the instrument, for example: `http://10.113.10.203`.

The instrument home page (welcome page) opens.

The navigation pane of the browser interface contains the following elements:

- "LXI"
 - "Home" opens the instrument home page. The home page displays device information, including the VISA resource string in read-only format. The "Device Indicator" button allows you to physically identify the instrument. This is useful if you have several instruments and want to know which instru-

- ment the LAN home page belongs to. To identify the instrument, activate the "Device Indicator". Then check the "LAN Status" indicator of the instruments.
- "LAN Configuration" allows you to configure LAN parameters and to initiate a ping.
(See ["Ping Client"](#) on page 172.)
 - "Utilities" provides access to an event log.
 - "Instrument Control"
 - "Web Control" provides remote access to the instrument via VNC (no installation required). Manual instrument controls are available via the front panel simulation.
 - "File Download" downloads files from the instrument.
 - "File Upload" uploads files to the instrument.(See [Chapter 8.5.5, "How to Control the R&S ZNL/ZNLE via the Web Browser Interface"](#), on page 176.)
 - "License Manager"
 - "License Manager" allows you to install or uninstall license keys and to activate, register or unregister licenses.
 - "Help"
 - "www.rohde-schwarz.com" opens the Rohde & Schwarz home page.

8.1.2 GPIB Interface (IEC 625/IEEE 418 Bus Interface)

An optional GPIB interface can be integrated on the rear panel of the instrument.

By connecting a PC to the R&S ZNL/ZNLE via the GPIB connection you can send remote commands to control and operate the instrument.

To be able to control the instrument via the GPIB bus, the instrument and the controller must be linked by a GPIB bus cable. A GPIB bus card, the card drivers and the program libraries for the programming language used must be provided in the controller. The controller must address the instrument with the GPIB bus address (see [Chapter 8.5.1.5, "How to Change the GPIB Instrument Address"](#), on page 172). You can set the GPIB address and the ID response string. The GPIB language is set as SCPI by default and cannot be changed for the R&S ZNL/ZNLE.

Notes and Conditions

In connection with the GPIB interface, note the following:

- Up to 15 instruments can be connected
- The total cable length is restricted to a maximum of 15 m or 2 m times the number of devices, whichever is less; the cable length between two instruments should not exceed 2 m.
- A wired "OR"-connection is used if several instruments are connected in parallel.
- Any connected IEC-bus cables should be terminated by an instrument or controller.

8.1.2.1 GPIB Interface Messages

Interface messages are transmitted to the instrument on the data lines, with the attention line (ATN) being active (LOW). They are used for communication between the controller and the instrument and can only be sent by a computer which has the function of a GPIB bus controller. GPIB interface messages can be further subdivided into:

- **Universal commands:** act on all instruments connected to the GPIB bus without previous addressing
- **Addressed commands:** only act on instruments previously addressed as listeners

Universal Commands

Universal commands are encoded in the range 10 through 1F hex. They affect all instruments connected to the bus and do not require addressing.

Command	Effect on the instrument
DCL (Device Clear)	Aborts the processing of the commands just received and sets the command processing software to a defined initial state. Does not change the instrument settings.
IFC (Interface Clear) *)	Resets the interfaces to the default setting.
LLO (Local Lockout)	The "Local" softkey is disabled. Manual operation is no longer available until <i>GTL</i> is executed.
SPE (Serial Poll Enable)	Ready for serial poll.
SPD (Serial Poll Disable)	End of serial poll.
PPU (Parallel Poll Unconfigure)	End of the parallel-poll state.
*) IFC is not a real universal command, it is sent via a separate line; however, it also affects all instruments connected to the bus and does not require addressing	

Addressed Commands

Addressed commands are encoded in the range 00 through 0F hex. They only affect instruments addressed as listeners.

Command	Effect on the instrument
GET (Group Execute Trigger)	Triggers a previously active instrument function (e.g. a sweep). The effect of the command is the same as with that of a pulse at the external trigger signal input.
GTL (Go to Local)	Transition to the "local" state (manual control).
GTR (Go to Remote)	Transition to the "remote" state (remote control).
PPC (Parallel Poll Configure)	Configures the instrument for parallel poll.
SDC (Selected Device Clear)	Aborts the processing of the commands just received and sets the command processing software to a defined initial state. Does not change the instrument setting.

8.2 SCPI (Standard Commands for Programmable Instruments)

SCPI commands - messages - are used for remote control. Commands that are not taken from the SCPI standard follow the SCPI syntax rules. The R&S ZNL/ZNLE supports the SCPI version 1999. The SCPI standard is based on standard IEEE 488.2 and aims at the standardization of device-specific commands, error handling and the status registers. The tutorial "Automatic Measurement Control - A tutorial on SCPI and IEEE 488.2" from John M. Pieper (R&S order number 0002.3536.00) offers detailed information on concepts and definitions of SCPI.

Tables provide a fast overview of the bit assignment in the status registers. The tables are supplemented by a comprehensive description of the status registers.

8.3 VISA Libraries

VISA is a standardized software interface library providing input and output functions to communicate with instruments. The I/O channel (LAN or TCP/IP etc.) is selected at initialization time by one of the following:

- The channel-specific address string ("VISA resource string") indicated in [Table 8-1](#)
- An appropriately defined VISA alias (short name).

A VISA installation is a prerequisite for remote control using the following interfaces:

- [Chapter 8.1.2, "GPIB Interface \(IEC 625/IEEE 418 Bus Interface\)"](#), on page 154
- [Chapter 8.1.1, "LAN Interface"](#), on page 150

For more information about VISA, refer to the user documentation.

8.4 Network and Remote Control Settings

Access: [SETUP] > "Network + Remote"

The remote commands required to define these settings are described in [Chapter 11.3.4.5, "Configuring the Network and Remote Control"](#), on page 567.

Step-by-step instructions are provided in [Chapter 8.5, "How to Set Up a Network and Remote Control"](#), on page 166.

- [General Network Settings](#)..... 157
- [Remote Settings](#)..... 158
- [Compatibility Settings](#)..... 161
- [LAN Settings](#)..... 162
- [Remote Errors](#)..... 163
- [Returning to Manual Mode \("Local"\)](#)..... 165

8.4.1 General Network Settings

Access: [SETUP] > "Network + Remote" > "Network" tab

The R&S ZNL/ZNLE can be operated in a local area network (LAN), for example to control the instrument from a remote PC or use a network printer.



Network settings can only be edited in the firmware if a LAN cable is connected to the R&S ZNL/ZNLE.

NOTICE

Risk of network problems

All parameters can be edited here; however, beware that changing the computer name has major effects in a network.

For details, see [Chapter 8.5, "How to Set Up a Network and Remote Control"](#), on page 166.

Computer Name	158
IP Address	158
Subnet Mask	158
DHCP	158
Network Configuration	158

Computer Name

Each instrument is delivered with an assigned computer name, but this name can be changed. The naming conventions of Windows apply. If too many characters and/or numbers are entered, an error message is displayed in the status line.

The default instrument name is a non-case-sensitive string with the following syntax:

<Type><variant>-<serial_number>

For example FPL1003-123456

The serial number can be found on the rear panel of the instrument. It is the third part of the device ID printed on the bar code sticker:

**IP Address**

Defines the IP address. The TCP/IP protocol is preinstalled with the IP address 10.0.0.10. If the DHCP server is available ("DHCP On"), the setting is read-only.

The IP address consists of four number blocks separated by dots. Each block contains 3 numbers in maximum (e.g. 100.100.100.100), but also one or two numbers are allowed in a block (as an example see the preinstalled address).

Subnet Mask

Defines the subnet mask. The TCP/IP protocol is preinstalled with the subnet mask 255.255.255.0. If the DHCP server is available ("DHCP On"), this setting is read-only.

The subnet mask consists of four number blocks separated by dots. Each block contains 3 numbers in maximum (e.g. 100.100.100.100), but also one or two numbers are allowed in a block (as an example see the preinstalled address).

DHCP

Switches between DHCP server available (On) or not available (Off). If a DHCP server is available in the network, the IP address and subnet mask of the instrument are obtained automatically from the DHCP server.

Network Configuration

Opens the standard Windows "Network Configuration" dialog box for further configuration.

8.4.2 Remote Settings

Access: [Setup] > "Network + Remote" > "Remote" tab



GPIB-specific settings are only available if option R&S FPL1-B10 is installed on the R&S ZNL/ZNLE.

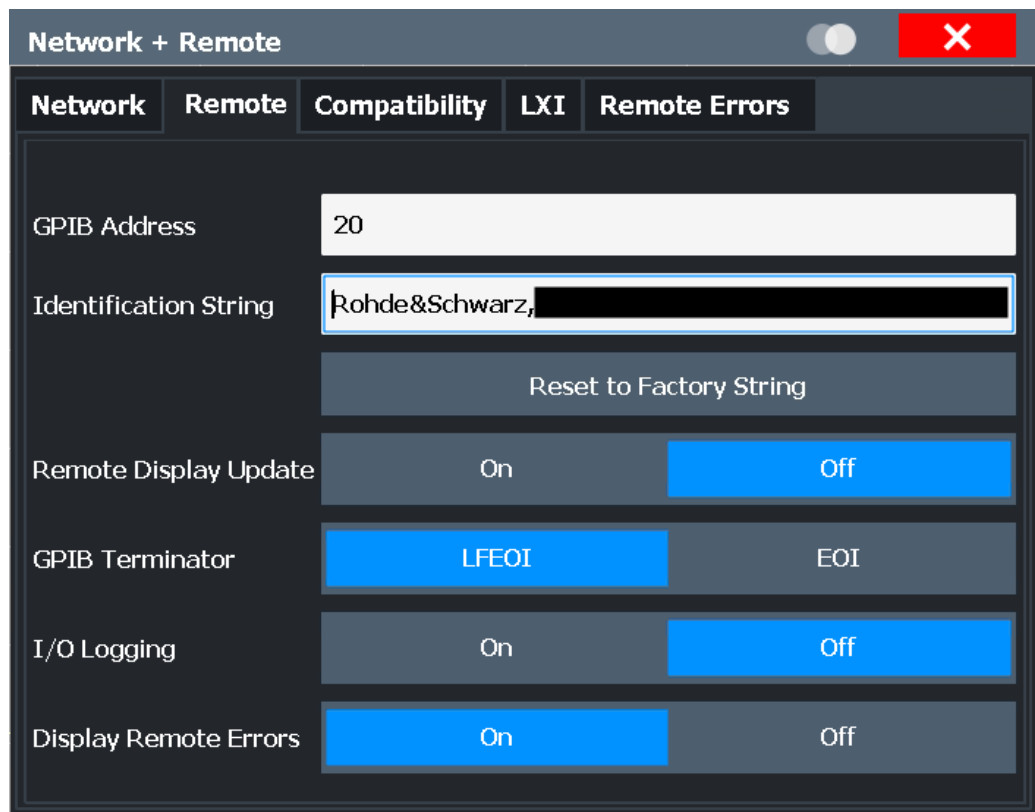

GPIB Address.....	159
Identification String.....	159
Reset to Factory String.....	159
Remote Display Update.....	160
GPIB Terminator.....	160
I/O Logging.....	160
Display Remote Errors.....	160

GPIB Address

Defines the GPIB address. Values from 0 to 30 are allowed. The default address is 20.

Remote command:

[SYSTem:COMMunicate:GPIB\[:SELF\]:ADDRESS](#) on page 567

Identification String

Defines the identification string for the R&S ZNL/ZNLE which is provided as a response to the `*IDN?` query. Maximum 36 characters are allowed.

Remote command:

[SYSTem:IDENTify\[:STRing\]](#) on page 569

Reset to Factory String

Restores the default identification string. Each R&S ZNL/ZNLE has a unique ID according to the following syntax:

Rohde&Schwarz,ZNL3,<Unique number>

Remote command:

`SYSTem:IDENtify:FACTory` on page 569

Remote Display Update

Defines whether the display of the R&S ZNL/ZNLE is updated when changing from manual operation to remote control.

Turning off the display update function improves performance during remote control.

Note: Usually, this function remains available on the display during remote operation. However, it can be disabled remotely. In this case, the display is not updated during remote operation, and cannot be turned on again locally until local operation is resumed.

Remote command:

`SYSTem:DISPlay:UPDate` on page 568

GPIB Terminator

Changes the GPIB receive terminator.

- | | |
|---------|---|
| "LFEOI" | According to the standard, the terminator in ASCII is <LF> and/or <EOI>. |
| "EOI" | For binary data transfers (e.g. trace data) from the control computer to the instrument, the binary code used for <LF> might be included in the binary data block, and therefore should not be interpreted as a terminator in this particular case. This can be avoided by using only the receive terminator <code>EOI</code> . |

Remote command:

`SYSTem:COMMunicate:GPIB[:SELF]:RTERminator` on page 567

I/O Logging

Activates or deactivates the SCPI error log function. All remote control commands received by the R&S ZNL/ZNLE are recorded in a log file. The files are named according to the following syntax:

```
C:\ProgramData\Rohde-Schwarz\ZNL-FPL\ScpiLogging\ScpiLog.<no.>
```

where <no.> is a sequential number

A new log file is started each time logging was stopped and is restarted.

Logging the commands may be extremely useful for debug purposes, e.g. in order to find misspelled keywords in control programs.

Remote command:

`SYSTem:CLOGging` on page 525

Display Remote Errors

Activates and deactivates the display of errors that occur during remote operation of the R&S ZNL/ZNLE. If activated, the R&S ZNL/ZNLE displays a message box at the bottom of the screen that contains the type of error and the command that caused the error.



The error message remains in place when you switch to "Local" mode. To close the message box, select the  "Close" icon.

Only the most recent error is displayed in remote mode. However, in local mode, all errors that occurred during remote operation are listed in a separate tab of the "Network + Remote" dialog box (see [Chapter 8.4.5, "Remote Errors"](#), on page 163).

Remote command:

`SYSTem:ERRor:DISPlay` on page 568

`SYSTem:ERRor:CLEar:REMote` on page 572

8.4.3 Compatibility Settings

Access: [SETUP] > "Network+Remote" > "Compatibility"

The R&S ZNL/ZNLE can emulate the GPIB interface of other signal and spectrum analyzers, e.g. in order to use existing control applications.



Compatibility with former R&S signal and spectrum analyzers

As a rule, the R&S ZNL/ZNLE supports most commands from previous R&S signal and spectrum analyzers such as the FSQ, FSP, FSU, or FSV. However, the default values, in particular the number of sweep points or particular bandwidths, may vary. Therefore, the R&S ZNL/ZNLE can emulate some other devices, including their default values, in order to repeat previous measurements or support existing control applications as in legacy systems.

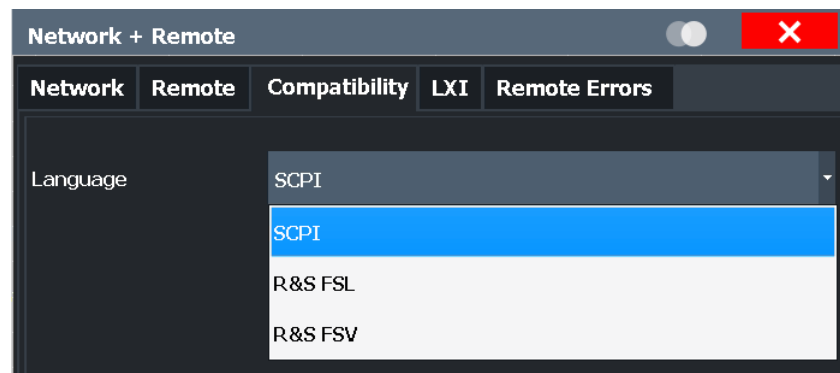

[Language](#)..... 161

Language

Defines the system language used to control the instrument.

Note: Emulating previous R&S signal and spectrum analyzers. This function is also used to emulate previous R&S signal and spectrum analyzers.

As a rule, the R&S ZNL/ZNLE supports most commands from previous R&S signal and spectrum analyzers. However, the default values, in particular the number of sweep points or particular bandwidths, may vary. Therefore, the R&S ZNL/ZNLE can emulate some other devices, including their default values, in order to repeat previous measurements or support existing control applications as in legacy systems.

- "SCPI" (Default) The default R&S ZNL/ZNLE commands are used.
- "FSV" The commands and settings for the R&S FSV instrument are used.
- "FSL" The commands and settings for the R&S FSL instrument are used.

Remote command:

[SYSTem:LANGuage](#) on page 569

8.4.4 LAN Settings

Access: [SETUP] > "Network + Remote" > "LAN" tab

In a LAN network, the R&S ZNL/ZNLE can be accessed via any web browser (e.g. the Microsoft Internet Explorer) to perform the following tasks:

- Modifying network configurations
- Modifying device configurations
- Monitoring connections from the device to other devices

The "LAN" tab of the "Network + Remote" dialog box provides basic LAN configuration functions and information for the R&S ZNL/ZNLE.

Alternatively, you can change the LAN settings using the web browser interface.

For details see [Chapter 8.5.1.4, "How to Configure the LAN Using the Web Browser Interface"](#), on page 170.

Only user accounts with administrator rights are able to use LAN configuration and web browser functionality.

Network	GPIB	Compatibility	LAN	Remote Errors
Current LAN Configuration:				
Computer Name		<input type="text"/>		
MAC Address		<input type="text"/>		
IP Address		<input type="text"/>		
LAN Password		<input type="password"/>		
		<input type="button" value="LAN Reset"/>		

Current LAN Configuration	163
LAN Password	163
LXI Reset	163

Current LAN Configuration

Displays the current LAN information from the R&S ZNL/ZNLE (read-only).

"Computer name"	Name of the R&S ZNL/ZNLE as defined in the operating system (see also " Computer Name " on page 158)
"MAC address"	Media Access Control address (MAC address), a unique identifier for the network card in the R&S ZNL/ZNLE
"IP address"	IP address of the R&S ZNL/ZNLE as defined in the operating system (see also " IP Address " on page 158).

LAN Password

Password for LAN configuration. The default password is *LxiWebIfc*.

Remote command:

[SYSTem:LXI:PASSword](#) on page 570

LXI Reset

Resets the "LXI" configuration to its default settings (LCI function).

Parameter	Value
TCP/IP Mode	DHCP + Auto IP Address
Dynamic DNS	Enabled
ICMP Ping	Enabled
Password for "LXI" configuration	LxiWebIfc

The LAN settings are configured in the "Network" tab of the "Network + Remote" dialog box or using the instrument's "LXI" web browser interface.

Remote command:

[SYSTem:LXI:LANReset](#) on page 570

8.4.5 Remote Errors

Access: [SETUP] > "Network + Remote" > "Remote Errors" tab

The error messages generated by the R&S ZNL/ZNLE during remote operation are displayed here.

The messages are displayed in the order of their occurrence; the most recent messages are placed at the top of the list.

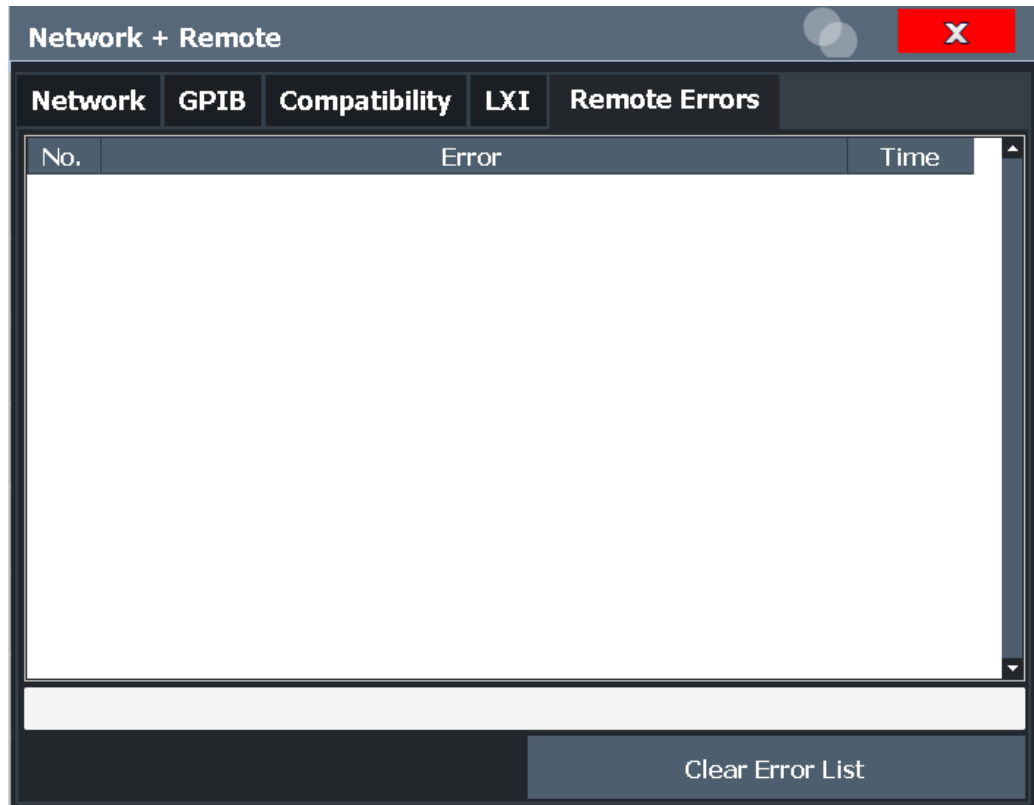

The most recent error message during remote operation can be displayed on the screen, see "[Display Remote Errors](#)" on page 160.

If the number of error messages exceeds the capacity of the error buffer, the oldest error message is removed before the newest one is inserted. To clear the message buffer use the "Clear Error List" button. It is automatically cleared when the R&S ZNL/ZNLE is shut down.

The following information is available:

No	Device-specific error code
Error	Brief description of the error
Date/Time	Time the message occurred

Remote command:

[SYSTem:ERRor:LIST?](#) on page 572

Clear Error List

Deletes the error message buffer for remote operation.

Note: The remote error list is automatically cleared when the R&S ZNL/ZNLE is shut down.

Remote command:

[SYSTem:ERRor:CLEar:REMote](#) on page 572

8.4.6 Returning to Manual Mode ("Local")

When switched on, the instrument is always in the manual measurement mode and can be operated via the front panel. As soon as the instrument receives a remote command, it is switched to the remote control mode.

In remote control mode, all keys of the instrument except the [PRESET] key are disabled. The "LOCAL" softkey and the [Remote Display Update](#) softkey are displayed.

Local

The instrument switches from remote to manual operation.

Note:

- If the local lockout function (LLO) has been activated in the remote control mode, manual operation is no longer available until GTL is executed.
- Before you switch back to manual operation, all remote command processing must be completed. Otherwise, the instrument will switch back to remote control immediately.
- If you select the "Local" softkey while a self-alignment or a self-test is still running (which was started remotely), the instrument only returns to the manual operation state when the alignment or test is completed.

Furthermore, when you return to manual operation, the following happens:

- All front panel keys are enabled.
- The main softkey menu of the current mode is displayed.
- The measurement diagrams, traces and display fields are displayed again.
- If, at the time of pressing the "LOCAL" softkey, the synchronization mechanism via *OPC, *OPC? or *WAI is active, the currently running measurement procedure is aborted and synchronization is achieved by setting the corresponding bits in the registers of the status reporting system.
- Bit 6 (User Request) of the Event Status Register is set.
If the status reporting system is configured accordingly, this bit immediately causes the generation of a service request (SRQ) to inform the control software that the user wishes to return to front panel control. For example, this can be used to interrupt the control program and to correct instrument settings manually. This bit is set each time the "LOCAL" softkey is pressed.

Remote command:

[SYSTem:KLOCK](#) on page 569

8.5 How to Set Up a Network and Remote Control

NOTICE

Risk of network failure

Consult your network administrator before performing the following tasks:

- Connecting the instrument to the network
- Configuring the network
- Changing IP addresses

Errors can affect the entire network.

Remote operation

You can operate the instrument remotely from a connected computer using SCPI commands. Before you send remote commands you must configure the instrument in a LAN network or connect it to a PC via the GPIB interface as described in [Chapter 8.5.1, "How to Configure a Network"](#), on page 166.

Remote Desktop

In production test and measurement, a common requirement is central monitoring of the T&M instruments for remote maintenance and remote diagnostics. Equipped with the Remote Desktop software of Windows, the R&S ZNL/ZNLE ideally meets requirements for use in production. The computer that is used for remote operation is called "controller" here.

The following tasks can be performed using Remote Desktop:

- Access to the control functions via a virtual front panel (soft front panel)
- Printout of measurement results directly from the controller
- Storage of measured data on the controller's hard disk

This documentation provides basic instructions on setting up the Remote Desktop for the R&S ZNL/ZNLE. For details refer to the Windows operating system documentation.

8.5.1 How to Configure a Network

A precondition for operating or monitoring the instrument remotely is that it is connected to a LAN network or a PC connected to the GPIB interface. Setup is described here.



Windows Firewall Settings

A firewall protects an instrument by preventing unauthorized users from gaining access to it through a network. Rohde & Schwarz highly recommends the use of the firewall on your instrument. R&S instruments are shipped with the Windows firewall enabled and preconfigured in such a way that all ports and connections for remote control are enabled. For more details on firewall configuration see the Windows help system and the R&S White Paper (available from the Rohde & Schwarz website):

[1EF96: Malware Protection Windows 10](#)

8.5.1.1 How to Connect the Instrument to the Network

There are two methods to establish a LAN connection to the instrument:

- A non-dedicated network (Ethernet) connection from the instrument to an existing network made with an ordinary RJ-45 network cable. The instrument is assigned an IP address and can coexist with a computer and with other hosts on the same network.
- A dedicated network connection (Point-to-point connection) between the instrument and a single computer made with a (crossover) RJ-45 network cable. The computer must be equipped with a network adapter and is directly connected to the instrument. The use of hubs, switches, or gateways is not required, however, data transfer is still performed using the TCP/IP protocol. An IP address has to be assigned to the instrument and the computer, see [Chapter 8.5.1.2, "How to Assign the IP Address"](#), on page 167.

Note: As the R&S ZNL/ZNLE uses a 1 GBit LAN, a crossover cable is not necessary (due to Auto-MDI(X) functionality).

- ▶ To establish a non-dedicated network connection, connect a commercial RJ-45 cable to one of the LAN ports.
To establish a dedicated connection, connect a (crossover) RJ-45 cable between the instrument and a single PC.

If the instrument is connected to the LAN, Windows automatically detects the network connection and activates the required drivers.

The network card can be operated with a 1 GBit Ethernet IEEE 802.3u interface.

8.5.1.2 How to Assign the IP Address

Depending on the network capacities, the TCP/IP address information for the instrument can be obtained in different ways.

- If the network supports dynamic TCP/IP configuration using the Dynamic Host Configuration Protocol (DHCP), all address information can be assigned automatically.
- If the network does not support DHCP, or if the instrument is set to use alternate TCP/IP configuration, the addresses must be set manually.

By default, the instrument is configured to use dynamic TCP/IP configuration and obtain all address information automatically. This means that it is safe to establish a physical connection to the LAN without any previous instrument configuration.



When a DHCP server is used, a new IP address may be assigned each time the PC is restarted. This address must first be determined on the PC itself. Thus, when using a DHCP server, it is recommended that you use the permanent computer name, which determines the address via the DNS server (see ["Using a DNS server to determine the IP address"](#) on page 169).

NOTICE

Risk of network errors

Connection errors can affect the entire network. If your network does not support DHCP, or if you choose to disable dynamic TCP/IP configuration, you must assign valid address information before connecting the instrument to the LAN. Contact your network administrator to obtain a valid IP address.

Assigning the IP address on the instrument

1. Press the [SETUP] key.
2. Press the "Network + Remote" softkey.
3. Select the "Network" tab.
4. In the "Network + Remote" dialog, toggle the "DHCP On/Off" setting to the required mode.
If DHCP is "Off", you must enter the IP address manually, as described in the following steps.
Note: When DHCP is changed from "On" to "Off", the previously set IP address and subnet mask are retrieved.
If DHCP is "On", the IP address of the DHCP server is obtained automatically. The configuration is saved, and you are prompted to restart the instrument. You can skip the remaining steps.
Note: When a DHCP server is used, a new IP address may be assigned each time the instrument is restarted. This address must first be determined on the instrument itself. Thus, when using a DHCP server, it is recommended that you use the permanent computer name, which determines the address via the DNS server (See ["Using a DNS server to determine the IP address"](#) on page 169 and [Chapter 8.5.1.3, "How to Change the Instrument Name"](#), on page 169).
5. Enter the "IP Address", for example *192.0.2.0*. The IP address consists of four number blocks separated by dots. Every block contains a maximum of 3 numbers.
6. Enter the "Subnet Mask", for example *255.255.255.0*. The subnet mask consists of four number blocks separated by dots. Every block contains a maximum of 3 numbers.
7. Close the dialog box.

If you have entered an invalid IP address or subnet mask, the message "out of range" is displayed in the status line. If the settings are correct, the configuration is saved, and you are prompted to restart the instrument.

8. Confirm the displayed message ("Yes" button) to restart the instrument.

Using a DNS server to determine the IP address

If a DNS server is configured on the R&S ZNL/ZNLE, the server can determine the current IP address for the connection using the permanent computer name.

1. Obtain the name of your DNS domain and the IP addresses of the DNS and WINS servers on your network (see [Chapter 8.5.1.3, "How to Change the Instrument Name"](#), on page 169).
2. Press the [Setup] key and then the "Network + Remote" softkey.
3. In the "Network" tab, select the "Open Dialog 'Network Connections'" button.
4. Double-tap the "Local Area Network" entry.
5. In the "Local Area Connection Status" dialog box, select the "Properties" button. The items used by the LAN connection are displayed.
6. Tap the entry named "Internet Protocol Version 4 (TCP/IPv4)" to highlight it.

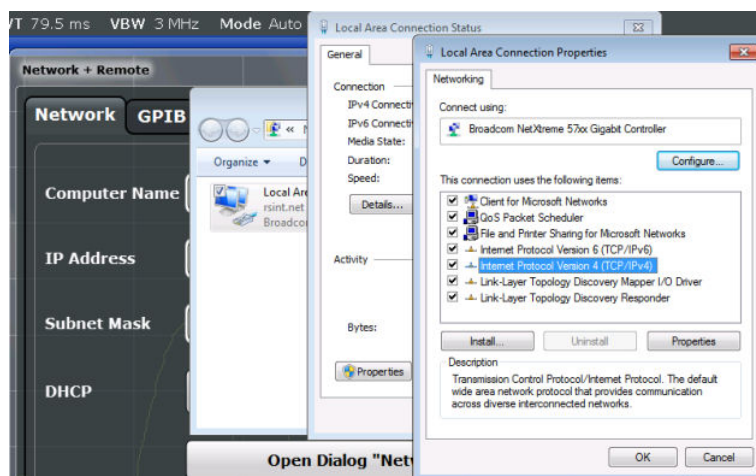

7. Select the "Properties" button.
8. On the "General" tab, select "Use the following DNS server addresses" and enter your own DNS addresses.

For more information refer to the Windows operating system Help.

8.5.1.3 How to Change the Instrument Name

In a LAN that uses a DNS server (Domain Name System server), each PC or instrument connected in the LAN can be accessed via an unambiguous computer name instead of the IP address. The DNS server translates the host name to the IP address.

This is especially useful when a DHCP server is used, as a new IP address may be assigned each time the instrument is restarted.

Each instrument is delivered with an assigned computer name, but this name can be changed.

To change the instrument's computer name

1. Press the [Setup] key and then the "Network + Remote" softkey.
The current "Computer Name" is displayed in the "Network" tab.
2. Enter the new computer name and close the dialog box.
The configuration is saved, and you are prompted to restart the instrument.
3. Confirm the displayed message ("Yes" button) to restart the instrument.

8.5.1.4 How to Configure the LAN Using the Web Browser Interface

The instrument's "LXI" web browser interface works correctly with all W3C compliant browsers.

- In the web browser, open the `http://<instrument-hostname>` or `http://<instrument-ip-address>` page, e.g. `http://10.113.10.203`.
The default password to change "LXI" configurations is *LxiWebIfc*.
The "Instrument Home Page" (welcome page) opens.

The screenshot shows a web browser window with the URL `http://172.23.226.47/web/html/ihp.php`. The page title is "Instrument Home Page". The interface features the Rohde & Schwarz logo and "LXI" branding. A navigation menu on the left includes sections for LXI, Instrument Control, License Manager, and Help. The main content area displays "Instrument Properties" for an R&S FPL1000 Spectrum Analyzer. The properties listed are:

Instrument Model	R&S FPL1000 Spectrum Analyzer
Manufacturer	Rohde & Schwarz GmbH & Co. KG
Serial Number	[REDACTED]
Description	R&S FPL1000-[REDACTED]
LXI Version	1.4 LXI Core 2011
LXI Extended Features	LXI HISLIP
DNS Host Name(s)	[REDACTED]
MAC Address	[REDACTED]
IP Address	172.23.226.47
Firmware Revision	1.20
Current Time	Tuesday, 2018/06/12, 06:53:10
Current Time source	Operating System
VISA resource string	TCPIP::172.23.226.47::inst0::INSTR TCPIP::172.23.226.47::hislip0::INSTR
Device Indicator	INACTIVE (press to toggle) ●

The instrument home page displays device information, including the VISA resource string, in read-only format.

- ▶ Press the "Device Indicator" button on the "Instrument Home Page" to activate or deactivate the "LXI" status LED to the right of the button. A green "LXI" status LED indicates that a LAN connection has been established; a red status LED indicates an error, for example, that no LAN cable is connected. When a device is connecting to the instrument, the "LXI" status LED blinks. The "Device Indicator" setting is not password-protected.

The most important control elements in the navigation pane of the browser interface are the following:

- "LAN Configuration" opens the menu with configuration pages.
- "Status" displays information about the "LXI" status of the instrument.

LAN Configuration

The LAN configuration consists of three parts:

- "IP configuration" provides all mandatory LAN parameters.
- "Advanced LAN Configuration" provides further LAN settings.
- "Ping Client" provides the ping utility to verify the connection between the instrument and other devices.

IP Configuration

The "LAN Configuration > IP configuration" web page displays all mandatory LAN parameters and allows their modification.

The "TCP/IP Mode" configuration field controls how the IP address for the instrument gets assigned (see also [Chapter 8.5.1.2, "How to Assign the IP Address"](#), on page 167).

For the manual configuration mode, the static IP address, subnet mask, and default gateway are used to configure the LAN. The automatic configuration mode uses DHCP server or Dynamic Link Local Addressing (Automatic IP) to obtain the instrument IP address.



Changing the LAN configuration is password-protected. The default password is *Lxi-WebIfc* (notice upper and lower case characters).

You can change the LAN password in the "Network + Remote" dialog box, see [Chapter 8.4.4, "LAN Settings"](#), on page 162.

Advanced LAN Configuration

The "LAN Configuration > Advanced LAN Configuration" parameters are used as follows:

- "mDNS and DNS-SD" are two additional protocols: Multicast DNS and DNS Service Discovery. They are used for device communication in zero configuration networks working without DNS and DHCP

- "ICMP Ping" must be enabled to use the ping utility.
- "VXI-11" is the protocol that is used to detect the instrument in the LAN.

Ping Client

Ping is a utility that verifies the connection between the instrument and another device. The ping command uses the ICMP echo request and echo reply packets to determine whether the LAN connection is functional. Ping is useful for diagnosing IP network or router failures. The ping utility is not password-protected.

To initiate a ping between the instrument and a second connected device:

To initiate a ping between the instrument and a second connected device

1. Enable "ICMP Ping" on the "Advanced LAN Configuration" page (enabled after an LCI).
2. Enter the IP address of the second device **without the ping command and without any further parameters** into the "Destination Address" field (e.g. *10.113.10.203*).
3. Select "Submit".

8.5.1.5 How to Change the GPIB Instrument Address

In order to operate the instrument via remote control, it must be addressed using the GPIB address. The remote control address is factory-set to 20, but it can be changed if it does not fit in the network environment. For remote control, addresses 0 through 30 are allowed. The GPIB address is maintained after a reset of the instrument settings.

Setting the GPIB address

1. On the R&S ZNL/ZNLE, press the [SETUP] key.
2. Press the "Network + Remote" softkey.
3. In the "Network + Remote" dialog box, select the "GPIB" tab.
4. In the "GPIB Address" field, enter a value between 0 and 30.

Remote command:

```
SYST:COMM:GPIB:ADDR 18
```

8.5.2 How to Operate the Instrument Without a Network

To operate the instrument without a network connection either temporarily or permanently, no special measures are necessary. Windows automatically detects the interruption of the network connection and does not set up the connection when the instrument is switched on.

If you are not prompted to enter the user name and password, proceed as described in [Chapter 8.5.3.3, "How to Configure the Automatic Login Mechanism"](#), on page 174.

8.5.3 How to Log on to the Network

Windows requires that users identify themselves by entering a user name and password in a login window. You can set up two types of user accounts, either an administrator account with unrestricted access to the computer/domain or a standard user account with limited access. The instrument provides an auto-login function for the administrator account, i.e. login with unrestricted access is carried out automatically in the background. By default, the user name for the administrator account is "Instrument", and the user name for the standard user account is "NormalUser". In both cases the initial password is "894129". You can change the password in Windows for any user at any time. Some administrative tasks require administrator rights (e.g. firmware updates or the configuration of a LAN network).

Refer to [Chapter 7, "General Instrument Setup"](#), on page 119 to find out which functions are affected.

At the same time you log on to the operating system, you are automatically logged on to the network. As a prerequisite, the user name and the password must be identical on the instrument and on the network.

8.5.3.1 How to Create Users

After the software for the network has been installed, the instrument issues an error message the next time it is switched on because there is no user named "instrument" (= default user ID for Windows auto-login) in the network. Thus, a matching user must be created in the R&S ZNL/ZNLE and in the network, the password must be adapted to the network password, and the auto-login mechanism must then be deactivated.

The network administrator is responsible for creating new users in the network.



Select the "Windows" icon in the toolbar to access the operating system.

2. Select "Start > Settings > Accounts > Other users".
3. Select "Add someone else to this PC".
4. In the "Microsoft account" dialog box, enter the new user name and password.
5. Select "OK".
6. Select "Finish".
The new user is created.

8.5.3.2 How to Change the User Password

After the new user has been created on the instrument, the password must be adapted to the network password.



Select the "Windows" icon in the toolbar to access the operating system.

2. Press [Ctrl + Alt + Delete], then select "Change a password".
3. Enter the user account name.
4. Enter the old password.
5. Enter the new password in the upper text line and repeat it in the following line.
6. Press [Enter].
The new password is now active.

8.5.3.3 How to Configure the Automatic Login Mechanism

Adapting the auto-login function to a new password

If you change the password that is used during auto-login, this function no longer works. Adapt the settings for the auto-login function first.

1. Open the
`C:\Users\Public\Documents\Rohde-Schwarz\ZNL\user\user\AUTOLOGIN.REG` file in any text editor (e.g. Notepad).
2. In the line `"DefaultPassword"="894129"`, replace the default password (894129) by the new password for automatic login.
3. Save the changes to the file.
4. In the Windows "Start" menu, select "Run".
The "Run" dialog box is displayed.
5. Enter the command
`C:\Users\Public\Documents\Rohde-Schwarz\ZNL\user\user\AUTOLOGIN.REG`.
6. Press the [ENTER] key to confirm.
The auto-login function is reactivated with the changed password. It will be applied the next time the instrument is switched on.

Switching users when using the auto-login function

Which user account is used is defined during login. If auto-login is active, the login window is not displayed. However, you can switch the user account to be used even when the auto-login function is active.



1. Select the "Windows" icon in the toolbar to access the operating system of the R&S ZNL/ZNLE (see also "To access the "Start" menu" on page 36).
2. Press [CTRL] + [ALT] + [DEL], then select "Sign out".
The "Login" dialog box is displayed, in which you can enter the different user account name and password.

Deactivating the auto-login function

When shipped, the instrument is already configured to automatically log on the "instrument" user under Windows. To deactivate the auto-login function, perform the following steps:

1. In the "Start" menu, select "Run".
The "Run" dialog box is displayed.
2. Enter the command
`C:\Users\Public\Documents\Rohde-Schwarz\ZNL\user\user\NO_AUTOLOGIN.REG.`
3. Press the [ENTER] key to confirm.
The auto-login function is deactivated. The next time you switch on the instrument, you are prompted to enter your user name and password before the firmware is started.

Reactivating the auto-login function

To reactivate the auto-login function after manually deactivating it, perform the following steps:

1. In the "Start" menu, select "Run".
The "Run" dialog box is displayed.
2. Enter the command
`C:\Users\Public\Documents\Rohde-Schwarz\ZNL\user\user\AUTOLOGIN.REG.`
3. Press the [ENTER] key to confirm.
The auto-login function is reactivated. It will be applied the next time the instrument is switched on.

8.5.4 How to Share Directories (only with Microsoft Networks)

Sharing directories makes data available for other users. This is only possible in Microsoft networks. Sharing is a property of a file or directory.

1. In the "Start" menu, select "Programs", "Accessories" and then select "Windows Explorer".
2. Select the desired folder with the right mouse button.
3. In the context menu, select "Sharing with > Specific people".
The dialog box for sharing a directory is displayed.
4. Select a user from the list or add a new name and select the "Add" button.
5. Select the "Share" button.
6. Select "Done" to close the dialog box.
The drive is shared and can be accessed by the selected users.

8.5.5 How to Control the R&S ZNL/ZNLE via the Web Browser Interface

Via the LAN web browser interface to the R&S ZNL/ZNLE, one or more users can control the instrument remotely from another PC without additional installation. Most instrument controls are available via the front panel simulation. File upload and download between the instrument and the remote PC is also available.

To access the R&S ZNL/ZNLE via the web browser interface

1. Start a web browser that supports html5 (W3C compliant).
2. Enter the IP address of the R&S ZNL/ZNLE in the browser's address bar.
The R&S ZNL/ZNLE's Welcome page is displayed.
3. In the navigation pane, select "Instrument Control > Web Control".
The instrument's display is shown in a new browser window, with a software front panel displayed beside or below it.
4. Use the mouse cursor to access the functionality in the software front panel or in the display as you would directly on the instrument's front panel.

To exchange files with the R&S ZNL/ZNLE

You can download files, for example stored measurement data, from the R&S ZNL/ZNLE to the remote PC, or upload files, for example limit line definitions, from the PC to the R&S ZNL/ZNLE.

1. In the web browser, select the Welcome page window.
2. In the navigation pane, select "Instrument Control" > "File Upload" or "File Download".

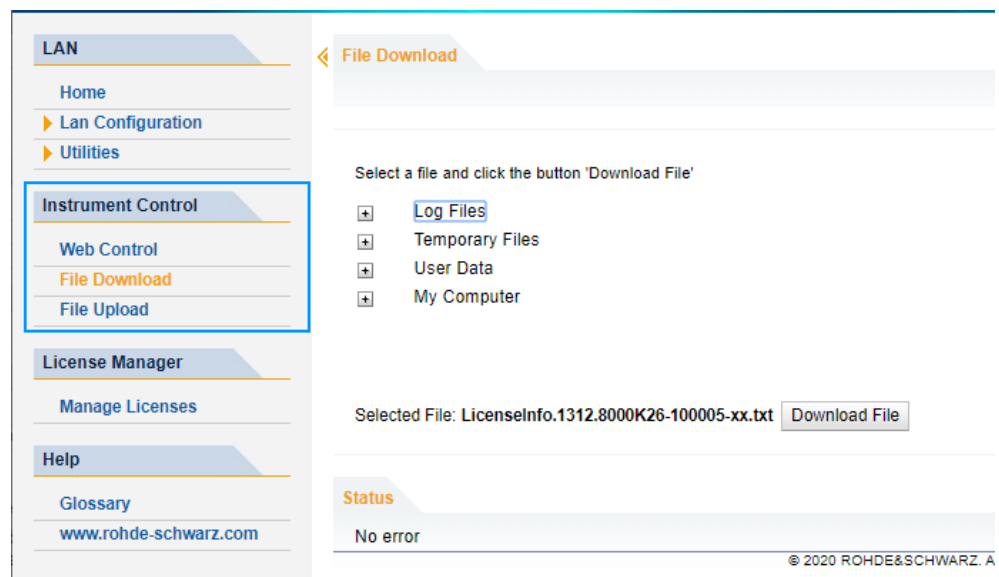

The most commonly used folders on the instrument are displayed, for example those that contain user data, as well as the top-most `My Computer` folder, from which you can access all other folders on the instrument.

3. To download a file from the R&S ZNL/ZNLE, select the file from the displayed folders and then select "Download File".
4. To upload a file to the R&S ZNL/ZNLE:
 - a) From the displayed folders in the web browser window, select the folder on the R&S ZNL/ZNLE to which you want to copy a file.
 - b) Under "File to Upload", select "Browse" to open a file selection dialog box and select the required file on the PC.
 - c) Select "Upload" to copy the file from the PC to the defined folder on the R&S ZNL/ZNLE.

8.5.6 How to Deactivate the Web Browser Interface

If you want to prevent other users in the LAN from accessing or operating the R&S ZNL/ZNLE via its LAN web browser interface, you must deactivate this function. Note that **after a firmware update** the function is **automatically active** again until you deactivate it manually.

To deactivate the LAN web browser interface

1.



Select the "Windows" icon in the toolbar to access the operating system.

2. In the "Start" menu, select "Control Panel".
3. Select "System and Security" > "Administrative Tools".

4. From the list on the right, select "Services".
5. From the list of local services, select "R&S TightVNC Server".

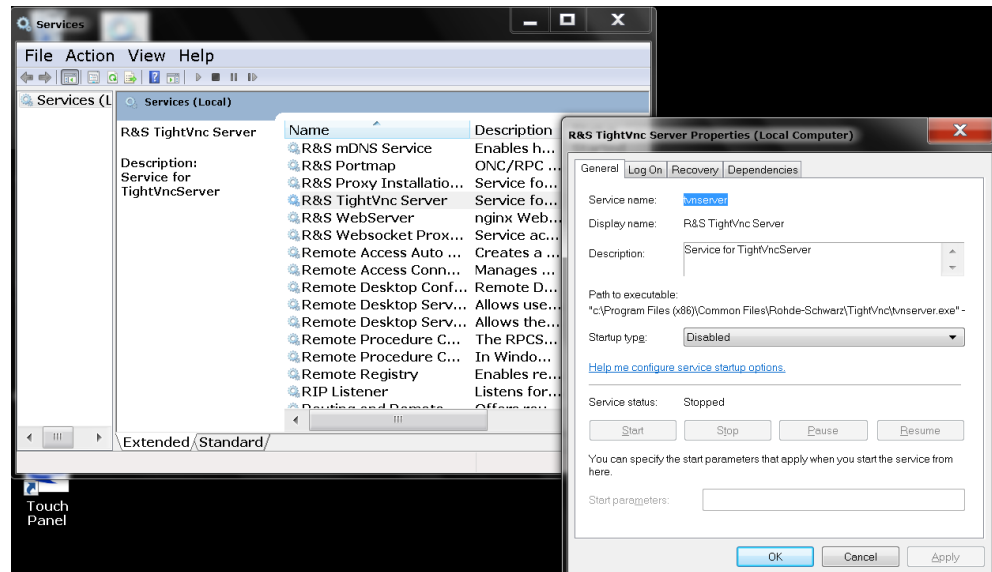

6. Set "Startup type" to "Disabled".
7. Select "Stop".
8. Select "Apply".

The next time a user enters the IP address of the instrument in a web browser, an error message is displayed:

```
Failed to connect to server (code. 1006)
```

8.5.7 How to Set Up Remote Desktop

Remote Desktop is a Windows application which can be used to access and control the instrument from a remote computer through a LAN connection. While the instrument is in operation, the instrument screen contents are displayed on the remote computer, and Remote Desktop provides access to all of the applications, files, and network resources of the instrument. Thus, remote operation of the R&S ZNL/ZNLE is possible.

With Windows, Remote Desktop Client is part of the operating system. For other versions of Windows, Microsoft offers the Remote Desktop Client as an add-on. For details refer to the Windows operating system documentation.

With the factory settings, the default "instrument" user can connect to the R&S ZNL/ZNLE with the Remote Desktop program of the controller immediately. No further configuration is required. However, if the connection fails or other users need to connect, this section provides basic instructions on setting up the Remote Desktop for the R&S ZNL/ZNLE.

8.5.7.1 How to Configure the R&S ZNL/ZNLE for Remote Operation via Remote Desktop

1. Create a fixed IP address for the TCP/IP protocol as described in [Chapter 8.5.1.2, "How to Assign the IP Address"](#), on page 167.

Note: To avoid problems, use a fixed IP address.

When a DHCP server is used, a new IP address is assigned each time the instrument is restarted. This address must first be determined on the instrument itself. Thus, using a DHCP server is not suitable for remote operation of the R&S ZNL/ZNLE via Remote Desktop.

2. 

Select the "Windows" icon in the toolbar to access the operating system.

3. In the Windows "Start" menu, select "Settings > System".
4. Search for "remote access".
5. Select "Allow remote access to your computer".
6. Define which users are to be given access to the R&S ZNL/ZNLE via Remote Desktop.

Note: The user account under which configuration is carried out is automatically enabled for Remote Desktop.

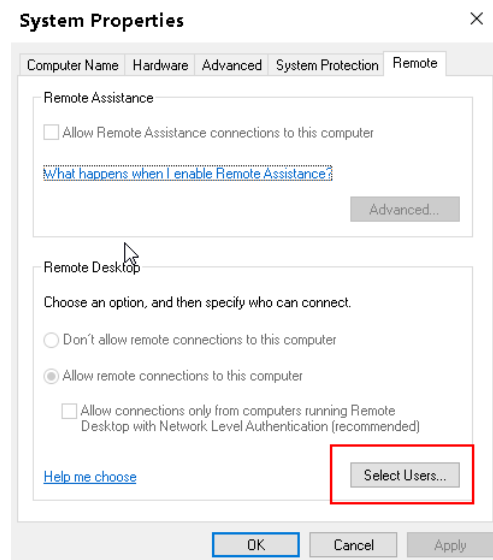

- a) Select the "Select Users" button.
- b) Select the users or create new user accounts as described in [Chapter 8.5.3.1, "How to Create Users"](#), on page 173.
- c) Select "OK" to confirm the settings.

- The R&S ZNL/ZNLE is now ready for connection setup with the Remote Desktop program of the controller.

8.5.7.2 How to Configure the Controller



Remote Desktop Client

With Windows, Remote Desktop Client is part of the operating system and can be accessed via "Start > Programs > Accessories > Remote Desktop Connection".

For other versions of Windows, Microsoft offers the Remote Desktop Client as an add-on.

1.



Select the "Windows" icon in the toolbar to access the operating system.

- From the "Start" menu, select "All Programs > Accessories > Remote Desktop Connection".

The "Remote Desktop Connection" dialog box is displayed.

- Select the "Options >>" button.

The dialog box is expanded to display the configuration data.

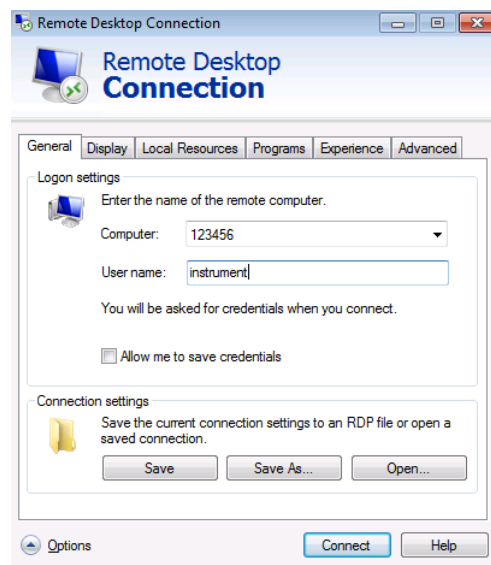

- Open the "Experience" tab.

The settings on this tab are used to select and optimize the connection speed.

- In the list, select the appropriate connection (for example: LAN (10 Mbps or higher)).

Depending on your selection (and how powerful the connection is), the options are activated or deactivated.

6. To improve the performance, you can deactivate the "Desktop background", "Show contents of window while dragging" and "Menu and window animation" options.
7. Open the "Local Resources" tab for enabling printers, local drives and serial interfaces.
8. If you will need to access drives of the controller from the R&S ZNL/ZNLE (e.g. in order to store settings or to copy files from the controller to the R&S ZNL/ZNLE), select "More", then enable the "Drives" option.

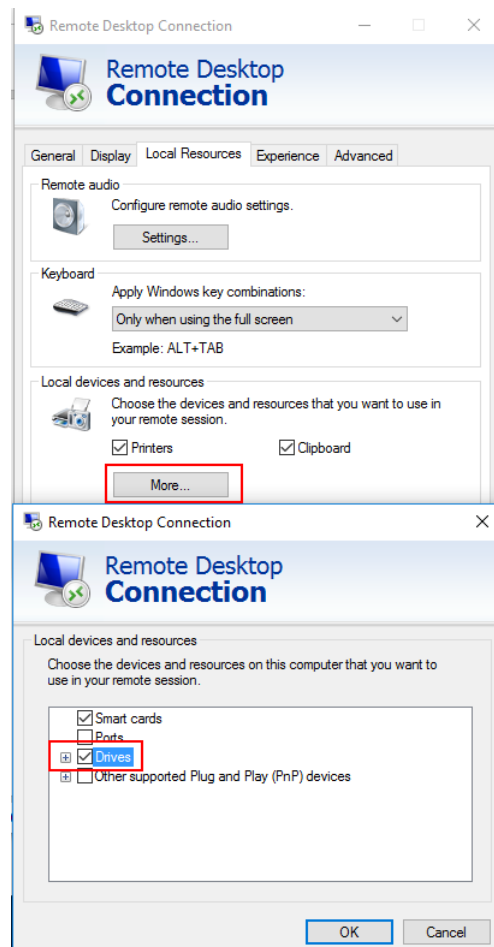

Windows will then map drives of the controller to the corresponding network drives.

9. To use printers connected to the controller while accessing them from the R&S ZNL/ZNLE, activate the "Printers" option. Do not change the remaining settings.
10. Open the "Display" tab.
The options for configuring the R&S ZNL/ZNLE screen display are displayed.
11. Under "Remote desktop size", you can set the size of the R&S ZNL/ZNLE window on the desktop of the controller.
12. Under "Colors", do not change the settings.

13. Set the "Display the connection bar when I use the full screen" option:
 - If activated, a bar showing the network address of the R&S ZNL/ZNLE will appear at the top edge of the screen. You can use this bar to reduce, minimize or close the window.
 - If deactivated, the only way you can return to the controller desktop from the R&S ZNL/ZNLE screen in full screen mode is to select "Disconnect" from the "Start" menu.

8.5.7.3 How to Start and Close the Remote Desktop

To set up a connection to the R&S ZNL/ZNLE

1. In the "Remote Desktop Connection" dialog box (see [Chapter 8.5.7.2, "How to Configure the Controller"](#), on page 180), open the "General" tab.
2. In the "Computer" field, enter the IP address of the R&S ZNL/ZNLE.
In the "User name" field, enter *instrument* to log in as an administrator, or *Normal User* to log in as a standard user.
In the "Password" field, enter *894129*.
3. To save the connection configuration for later use:
 - a) Select the "Save As" button.
The "Save As" dialog box is displayed.
 - b) Enter the name for the connection information (*.RDP).
4. To load an existing connection configuration:
 - a) Select the "Open" button.
The "Open" dialog box is displayed.
 - b) Select the *.RDP file.
5. Select the "Connect" button.
The connection is set up.
6. If the "Disk drives" option is activated on the "Local Resources" tab, a warning is displayed indicating that the drives are enabled for access from the R&S ZNL/ZNLE.
Select "OK" to confirm the warning.
7. After a few moments, the R&S ZNL/ZNLE screen is displayed.
If a dark screen appears or a dark square appears in the upper left-hand corner of the screen, you must restart the R&S ZNL/ZNLE in order to see the modified screen resolution.

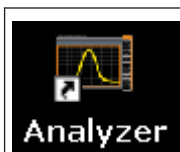

- Press the key combination [ALT] + [F4].
- The R&S ZNL/ZNLE firmware is shut down, which may take a few seconds.
- On the desktop, double-tap the "Analyzer" icon.

The firmware restarts and then automatically opens the "Soft Front Panel", i.e. the user interface on which all front panel controls and the rotary knob are mapped to buttons.

For more information see [Chapter 7.2.2, "How to Work with the Soft Front Panels"](#), on page 128.

- To deactivate or activate the "Softfrontpanel", press the [F6] key. After the connection is established, the R&S ZNL/ZNLE screen is displayed in the "Remote Desktop" application window.

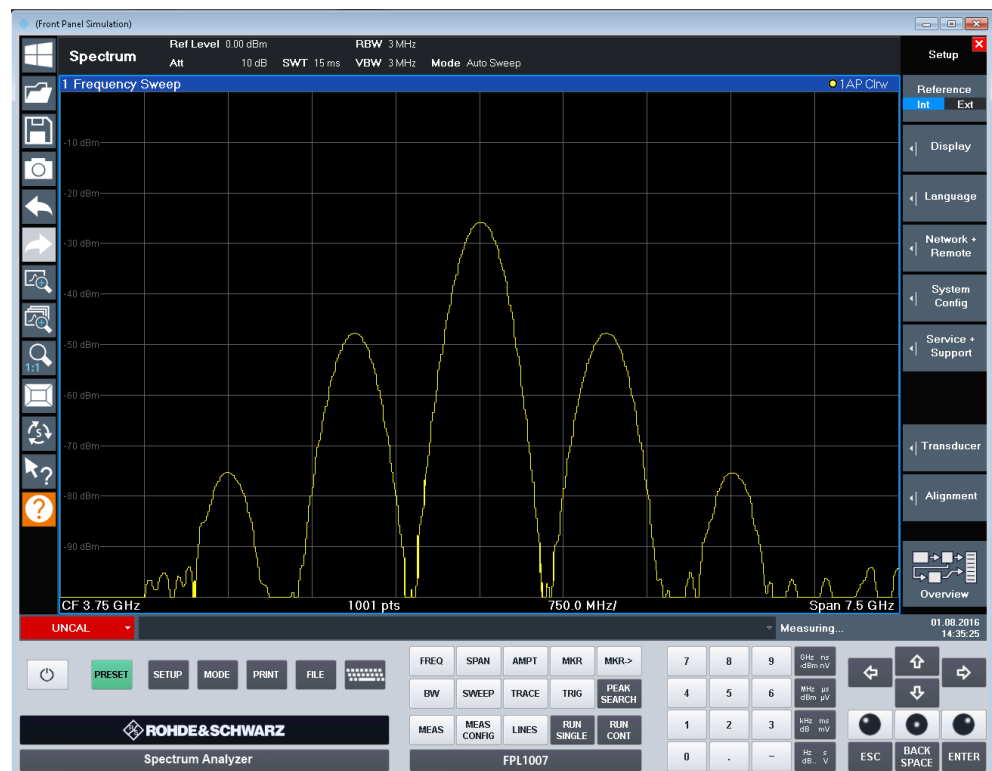

The Windows "Start" menu can be made available by expanding the "Remote Desktop" window to full size.

During the connection with the controller, the login entry is displayed on the R&S ZNL/ZNLE screen.

To terminate Remote Desktop control

The connection can be terminated by the controller or by a user at the R&S ZNL/ZNLE:

- On the controller, close the "Remote Desktop" window at any time. The connection to the R&S ZNL/ZNLE is terminated.
- On the R&S ZNL/ZNLE, a user logs on. The connection to the controller is terminated as a result. A message is displayed on the controller display indicating that another user has assumed control of the instrument.

Restoring the connection to the R&S ZNL/ZNLE

Follow the instructions above for setting up a connection to the R&S ZNL/ZNLE. If the connection is terminated and then restored, the R&S ZNL/ZNLE remains in the same state.

8.5.7.4 How to Shut Down the R&S ZNL/ZNLE via Remote Operation

1. Select the R&S ZNL/ZNLE softfrontpanel and close the application with the key combination [ALT] + [F4].
2. Select the desktop and press the key combination [ALT] + [F4].
A safety query is displayed to warn you that the instrument cannot be reactivated via remote operation and asks you whether you want to continue the shutdown process.
3. Respond to the safety query with "Yes".
The connection with the controller is terminated and the R&S ZNL/ZNLE is shut down.

8.5.8 How to Start a Remote Control Session from a PC

When you switch on the R&S ZNL/ZNLE, it is always in manual operation state ("local" state) and can be operated via the front panel.

To start remote control

1. Send an addressed command (`GTR` - Go to Remote) from a controller to the instrument.

The instrument is switched to remote control ("remote" state). Operation via the front panel is disabled. Only the "Local" softkey is displayed to return to manual operation. The instrument remains in the remote state until it is reset to the manual state via the instrument or via remote control interfaces. Switching from manual operation to remote control and vice versa does not affect the other instrument settings.
2. During program execution, send the `SYSTem:DISPlay:UPDate ON` command to activate the display of results (see `SYSTem:DISPlay:UPDate` on page 568).

The changes in the device settings and the recorded measurement values are displayed on the instrument screen.
3. To obtain optimum performance during remote control, send the `SYSTem:DISPlay:UPDate OFF` command to hide the display of results and diagrams again (default setting in remote control).
4. To prevent unintentional return to manual operation, disable the keys of the instrument using the universal command `LLO`.

Switching to manual mode is only possible via remote control then. This function is only available for the GPIB interface.

5. To enable the keys of the R&S ZNL/ZNLE again, switch the instrument to local mode (GTL - Go to Local), i.e. deactivate the REN line of the remote control interface.



If the instrument is operated exclusively in remote control, it is recommended that you switch off the display. For details see ["Remote Display Update"](#) on page 160.

8.5.9 How to Return to Manual Operation

Before you switch back to manual operation, all remote command processing must be completed. Otherwise, the instrument will switch back to remote control immediately.

- ▶ Select the "Local" softkey, or use the following GPIB command:

```
status = viGpibControlREN(vi, VI_GPIB_REN_ADDRESS_GTL)
```



If you select the "Local" softkey while a self-alignment or a self-test is still running (which was started remotely), the instrument only returns to the manual operation state when the alignment or test is completed.

9 VNA Concepts and Features

The following chapter provides an overview of the instrument's VNA capabilities and their use. It contains a description of the basic concepts that the analyzer uses to organize, process and display measurement data. Also included are descriptions of the screen contents, possible measured quantities, calibration methods and typical test setups.

For a systematic explanation of all softtools, functions and parameters refer to [Chapter 10, "VNA GUI Reference"](#), on page 294.

9.1 Basic Concepts

The VNA mode provides various functions to perform a particular measurement and to customize and optimize the evaluation of results. To ensure that the instrument resources are easily accessible and that user-defined configurations can be conveniently implemented, stored and reused, the instrument uses a hierarchy of structures:

- Global resources can be used for all measurements, irrespective of the current measurement session.
- All non-global settings of the current measurement session (comprising one or more channel setups) can be saved to an instrument settings file (*.df1) and later recalled.
- A channel setup comprises a set of diagrams together with the underlying system, channel, trace and display settings. It can be saved to a channel setup file and later recalled.
- The diagrams show traces which are assigned to channels. See [Chapter 9.1.3, "Traces, Channels and Diagrams"](#), on page 187.

9.1.1 Global (Persistent) Settings

The VNA mode manages global settings that apply to all measurements, irrespective of the current measurement setup. The following list contains examples of global settings:

- Calibration kits
- Connector types
- Cal pool data including system error correction and power correction data
- Directories for trace data, limit lines, calibration data etc.
- Global VNA mode settings, to be accessed via [Setup] > "VNA Setup"

Global settings are not part of an instrument settings or channel setup file, nor are they affected by an instrument [Preset]. Some of them can be "Reset" in the VNA Setup dialog.

Some settings are session-specific, i.e. they are initialized to default when a new measurement session is started (session settings).

9.1.2 Channel Setups

A channel setup comprises a set of diagrams together with the underlying system, channel, trace and display settings. The R&S ZNL/ZNLE can handle multiple channel setups in parallel, each of them displayed in a separate tab.



Either the active channel setup or the set of all open channel setups can be saved to a settings file (*.df1) and recalled at a later point in time or at another instrument. Use [File] > "Save"/"Recall" to organize channel setups.



A channel setup only contains setup instructions, i.e. information on how to measure, how to process the measurement results, and how to display the processed results. It does **not** contain any trace or result data.

9.1.3 Traces, Channels and Diagrams

The analyzer arranges, displays or stores the measured data in traces which are assigned to channels and displayed in diagrams. To understand the functions of the instrument and quickly find the appropriate settings, it is important to understand the exact meaning of the three terms.

- A trace is a set of data points that can be displayed together in a diagram. The trace settings specify the mathematical operations used to obtain traces from the measured or stored data and to display them.
- A channel contains hardware-related settings which specify how the network analyzer collects data.
- A diagram is a rectangular portion of the screen which is used to display traces. Diagrams belonging to the same channel setup are arranged in a common tab. The settings for diagrams are described in [Chapter 9.2.1, "Display Elements of a VNA Diagram"](#), on page 196.

A diagram can contain a practically unlimited number of traces, assigned to different channels. Diagrams and channels are independent from each other.

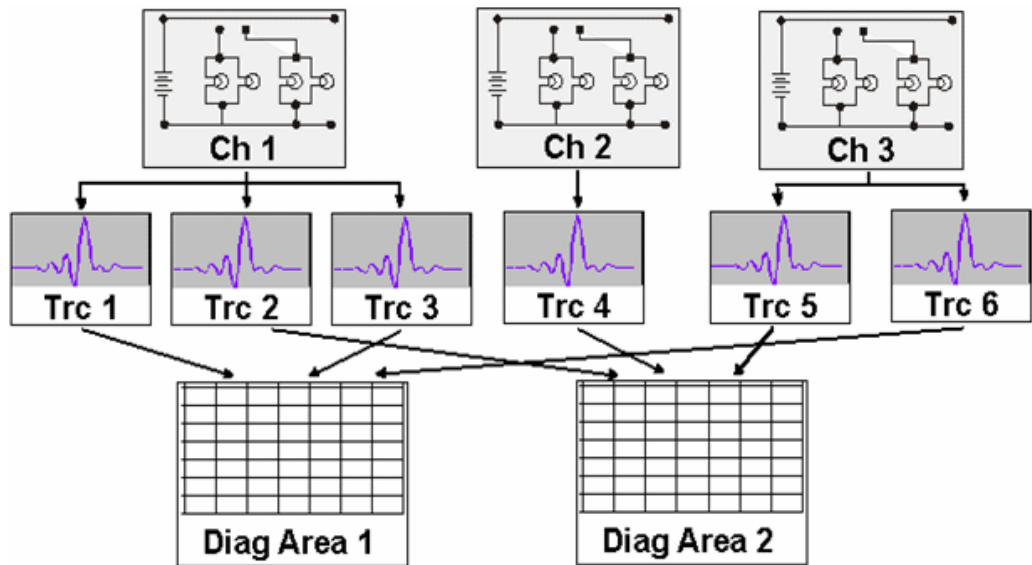

9.1.3.1 Trace Settings

The trace settings specify the mathematical operations used to obtain traces from the measured or stored data. They can be divided into several main groups:

- Selection of the measured quantity (S-parameters, wave quantities, ratios, impedances,...)
- Conversion into the appropriate display format and selection of the diagram type
- Scaling of the diagram and selection of the traces associated to the same channel
- Readout and search of particular values on the trace by means of markers
- Limit check

The trace settings can be accessed via the function keys [Meas], [Format], [Scale], [Trace], [Line], [Mkr] and [Mkr->]. They complement the [Channel Settings](#).

Each trace is assigned to a channel. The channel settings apply to all traces of the channel.

9.1.3.2 Channel Settings

A channel contains hardware-related settings which specify how the network analyzer collects data. The channel settings can be divided into three main groups:

- Description of the test setup (power of the internal source, IF filter bandwidth, port configuration, receiver step attenuators, ...)
- Control of the measurement process (sweep, trigger, averaging, ...)
- Correction data (calibration, offset, ...)



Receiver step attenuators are not available for the R&S ZNLE (see [Chapter 9.7.6](#), "[Receiver Step Attenuators](#)", on page 291).

The channel settings can be accessed via the function keys [Freq], [Span], [Bw Avg Power], [Sweep], [Cal], [Channel], [Trigger] and [Offset Embed].

9.1.3.3 Active and Inactive Traces and Channels

A window can display several diagrams simultaneously, each with a variable number of traces. One of these traces is active at each time. The **active trace** is highlighted in the trace list on top of the active diagram (Trc4 in the figure below):

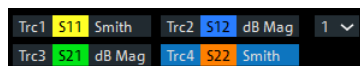

When a trace is selected in the diagram area, it becomes the **active trace**. If a previously inactive area is selected as the active area, the trace that was active last time when the area was active again becomes the active trace.

The **active channel** is the channel which belongs to the active trace. The channels of all traces in a diagram are listed at the bottom of the diagram, together with the "Stimulus" values and the display colors of all traces. The active channel is highlighted.

Ch1	Start	5 kHz	—	Pwr	-10 dBm	Bw	10 kHz	Stop	6 GHz
Ch2	Freq	1 GHz	—	Pwr	-10 dBm	Bw	10 kHz	Stop	201
Ch3	Freq	1 GHz	—	Pwr	-10 dBm	Bw	10 kHz	Stop	1 s
Ch4	Start	5 kHz	—	Pwr	-10 dBm	Bw	10 kHz	Stop	6 GHz
Trc4	Start	-1 ns	—	Time Domain				Stop	4 ns

Channels with no traces are not indicated in the diagrams but can be accessed via the "Channel Manager" dialog.



In manual control, there is always exactly one active trace, irrespective of the number of channels and traces defined. In remote control, each channel contains an active trace.

See also [Chapter 11.4.2, "Basic Remote Control Concepts"](#), on page 576.

9.1.4 Sweep Control

A sweep is a series of consecutive measurements taken over a specified sequence of stimulus values. It represents the basic measurement cycle of the analyzer.

The analyzer can perform:

- sweeps at constant power but variable frequency (frequency sweeps)
- sweeps at constant power and frequency that are repeated in time (Time/CW Mode sweeps)

The sweeps are further specified by the number of measurement points and the total measurement time.

By default, sweeps are repeated continuously. Alternatively, a measurement can also consist of a single sweep or of a specified number of sweeps.



After changing the channel settings or selecting another measured quantity, the analyzer needs some time to initialize the new sweep. This preparation period increases with the number of points and the number of partial measurements involved. It is indicated in the status bar:



All analyzer settings can still be changed during sweep initialization. If necessary, the analyzer terminates the current initialization and starts a new preparation period.

9.1.4.1 Partial Measurements and Driving Mode

Depending on the measurement task and the measured quantities, the measurement at each sweep point can consist of one or several "partial measurements" with definite hardware settings.

- If a single S-parameter is measured (e.g. the reflection coefficient S_{11}), the analyzer can operate at fixed hardware settings. In particular, a fixed source port and receive port is used. Each sweep point requires a single partial measurement. See also [Chapter 9.3.1, "S-Parameters"](#), on page 218.
- For a complete two-port S-parameter measurement (e.g. S_{11} , S_{21} , S_{12} , S_{22}) the analyzer needs to interchange the roles of the source and receive ports. Each sweep point requires two partial measurements.

To improve the accuracy, it is possible to insert a delay time before each partial measurement.

In the default **"Alternated"** driving mode, the R&S ZNL/ZNLE performs a partial measurement at all sweep points (partial sweep) before the hardware settings are changed. The next partial measurement is carried out in an additional sweep. In the **"Chopped"** driving mode, the order is reversed, i.e. the measurement proceeds sweep point per sweep point, with varying hardware settings.

See [Channel] > "Mode" > "Driving Mode".

Advantages of alternated and chopped driving mode

If the settling time between sweep points is smaller than the settling time between hardware settings (which is generally true), then the "Alternated" mode is faster than the "Chopped" mode. On the other hand, the "Chopped" mode builds up traces sweep point per sweep point, whereas in the "Alternated" mode you have to wait for the last partial sweep.



Use the "Alternated" mode to increase the accuracy of measurements on DUTs with long level settling times (e.g. quartzes, SAW filters). To measure DUTs with short settling times and obtain a trace from the beginning of the sweep, use "Chopped" mode. In "Auto" mode, the analyzer optimizes the display update: Fast sweeps are performed in "Alternated" mode, slower sweeps in "Chopped" mode.

As an alternative to activating the "Alternated" mode, it is possible to insert a measurement delay before each partial measurement and thus improve the accuracy.

See [Sweep] > "Sweep Params" > "Meas Delay".

However, the delay slows down the measurement.

Relation to trigger settings

In triggered measurements, "Alternated" has no effect if the triggered measurement sequence is identical to a single sweep point. The following table shows how the analyzer performs a sweep comprising m sweep points, assuming that each of them requires n partial measurements.

Triggered Meas. Sequence	"Alternated" mode	"Chopped" mode
Sweep	Trigger event starts n partial sweeps over all sweep points.	Trigger event starts m complete measurements at consecutive sweep points.
Sweep Segment	Trigger event starts n partial sweeps over the next segment.	Trigger event starts complete measurements at all consecutive sweep points in the segment.
Point	All partial measurements of each sweep point are carried out one after another.	All partial measurements of each sweep point are carried out one after another.
Partial Measurement	Each partial measurement is carried out for all sweep points.	All partial measurements of each sweep point are carried out one after another

9.1.4.2 Stimulus and Sweep Types

The function of the [Freq] and [Span] hardkeys depends on the sweep type.

Table 9-1: Function of [Freq] and [Span] function keys

Sweep type	[Freq] (unit)	[Span] (unit)
"Lin Freq"	"Center Frequency" (Hz)	"Span Frequency" (Hz)
"Log Freq"	"Start Frequency" (Hz)	"Stop Frequency" (Hz)
"Segmented"	–	–
"CW Mode"	"CW Frequency" (Hz)	"Number of Points" (-)
"Time"	"CW Frequency" (Hz)	"Stop Time" (s)

The ranges of numerical values must be compatible with the instrument model. The conditions for the stimulus range depend on the sweep type:

- **"Lin Freq" / "Log Freq" / "Segmented"**
The supported frequency range depends on the instrument type; for an overview refer to [Table 11-18](#).
 - For "Lin Freq" and "Log Freq" sweeps, if the number of sweep points is greater than 1, the stop frequency must be greater than the start frequency and the span must be ≥ 1 Hz. If a stop frequency smaller or equal than the current start frequency is set, then the start frequency is adjusted and vice versa.
 - For "Segmented" sweeps, the start and stop frequency in a sweep segment must not be different. So with a segmented sweep you can measure n_1 points at frequency f_1 (in segment 1), n_2 points at frequency f_2 (in segment 2) etc.
- **"CW Mode"**
The [Freq] and [Span] function keys define the fixed stimulus frequency ("CW Frequency") and the "Number of Points" of the measurement. The other sweep parameters (e.g. the "Sweep Time") are set via [Sweep] > "Sweep Params".
- **"Time"**
The [Freq] and [Span] function keys define the fixed stimulus frequency ("CW Frequency") and the total sweep time ("Stop Time") of the measurement. The other sweep parameters (e.g. the "Number of Points") are set via [Sweep] > "Sweep Params".
The sweep time is entered in seconds and must be positive.



The selected sweep range applies to all source and receive ports of the analyzer.

9.1.5 Data Flow

The analyzer processes the raw measurement data in a sequence of stages to obtain the displayed trace. The following subsections give an overview.

9.1.5.1 Channel Data Flow

The diagram below illustrates the data processing stages for the entire channel. All stages are configurable.

Note that the channel data flow for S-parameters (and quantities derived from S-parameters such as impedances, admittances, stability factors) differs from the channel data flow for wave quantities (and derived quantities such as ratios).

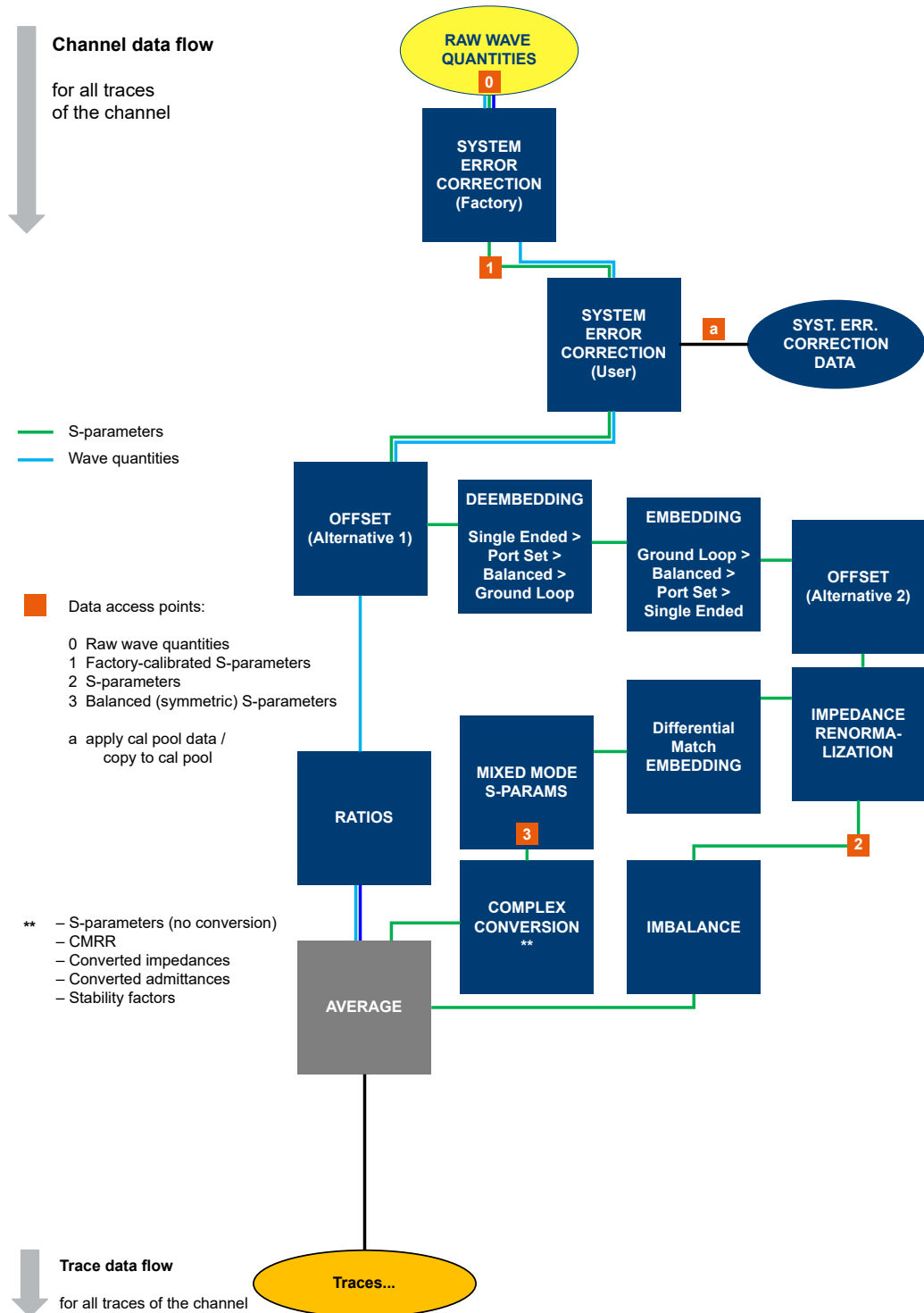
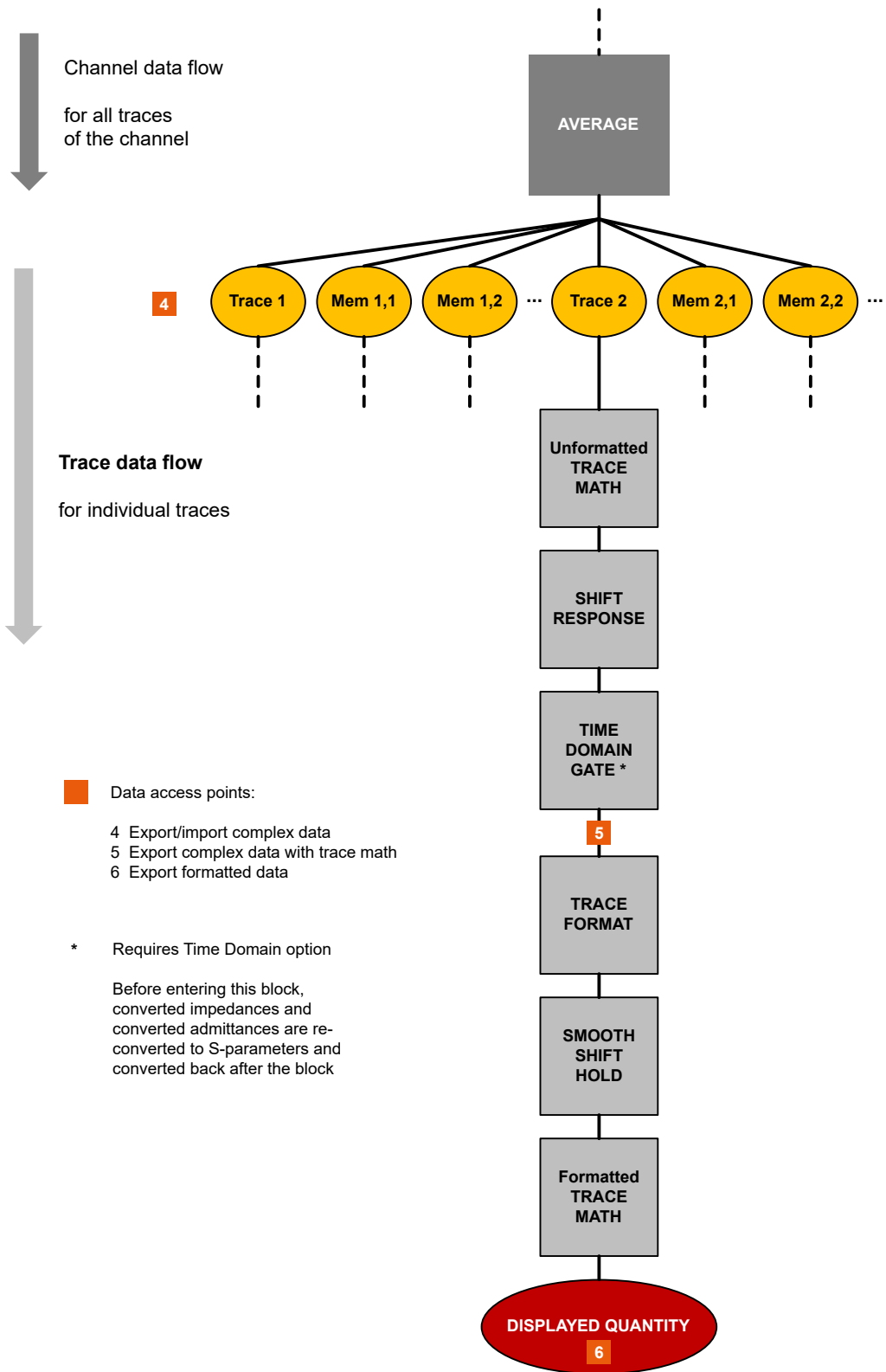

Figure 9-1: Channel data flow

9.1.5.2 Trace Data Flow

The diagram below illustrates the processing stages the channel measurement data run through for each individual trace. Again, all stages are configurable.



9.2 VNA Screen Elements

This section describes manual operation of the VNA mode, including trace settings, markers and diagrams. For a description of the different quantities measured by the instrument, refer to [Chapter 9.3, "Measurement Results"](#), on page 217.

9.2.1 Display Elements of a VNA Diagram

The central part of the screen is occupied by one or more diagrams.

A diagram is simply a rectangular portion of the screen used to display traces. Diagrams are independent of trace and channel settings. A diagram can contain a practically unlimited number of traces which can be assigned to different channels.

Most diagram settings are arranged on the "Diagram" and "Split" tabs of the "Display Lines" softtool. To assign traces and channels to diagrams, use the control elements on the Trace > "Traces" and Channel > "Channels" softtool tabs (hardkeys [Trace] and [Channel]).

Diagrams can contain:

- A title (optional)
- The diagram number (or label)
- Measurement results, in particular traces and marker values (optional)
- An indication of the basic channel and trace settings
- Context menus providing settings which are related to a particular display element



The examples in this section have been taken from Cartesian diagrams. All other diagram types provide the same display elements.

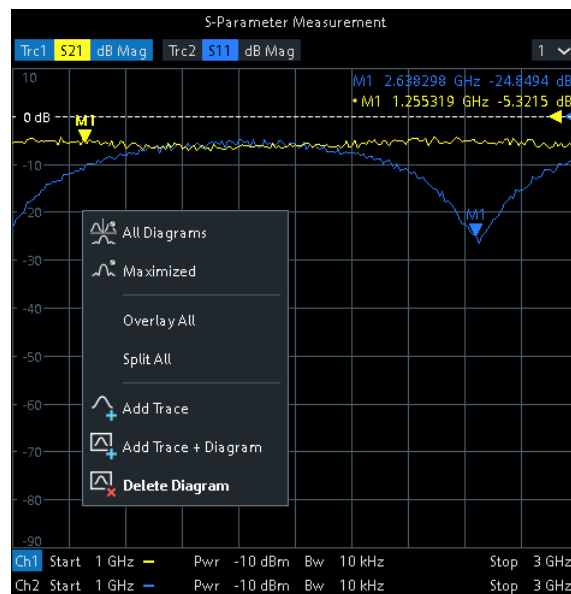

9.2.1.1 Title

An optional title across the top of the diagram can be used for a brief description of the diagram contents.

S-Parameter Measurement



Select [Display Lines] > "Diagram" > "Title" to enter the diagram title and "Show Title" to display or hide it.

9.2.1.2 Traces

A trace is a set of data points displayed together in the diagram. The individual data points are connected so that each trace forms a continuous line.

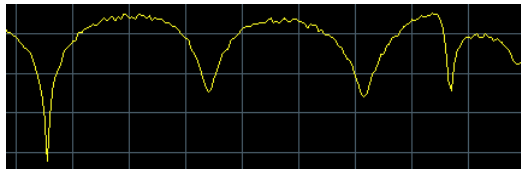

The trace can be complemented by the following display elements, plotted with the same color:

- Reference value (for all traces): The reference value is indicated with a triangle at the right edge of the diagram and a dashed, horizontal line. The value and position of the triangle can be changed to modify the diagram scale and shift the trace vertically.
- Measured quantity (for the active trace): The measured quantity is indicated in the trace list; see ["Trace List and Trace Settings"](#) on page 198.

A trace can be either a data trace, a memory trace, or a mathematical trace; see ["Trace Types"](#) on page 197.

Trace Types

The VNA mode uses traces to display the current measurement result in a diagram. It is also capable of storing traces to the memory, recalling stored traces, and defining mathematical relations between different traces. There are three basic trace types:

- Data traces show the current measurement data and are continuously updated as the measurement goes on. Data traces are dynamic traces.
- Memory traces are generated by storing the data trace to the memory. They represent the state of the data trace at the moment when it was stored. Memory traces are static traces which can be stored to a file and recalled.
- Mathematical traces are calculated according to a mathematical relation between constants and the data or memory traces of the active channel setup. A mathematical trace that is based on the active data trace is dynamic.

It is possible to generate an unlimited number of memory traces from a data trace and display them together. Markers and marker functions are available for all trace types.



The type of each trace in a diagram is indicated in the trace list: "MEM<no>" at the beginning of the trace name indicates a memory trace (with default naming), Math at the end of the trace label indicates a mathematical trace. You can also hide a trace ("Invisible") without deleting it.

Trc1	S11	dB Mag	10 dB/ Ref 0 dB	Ch1	Math	Mem5[Trc1]	S11	dB Mag	10 dB/ Ref 0 dB	Ch1
Trc5	S21	dB Mag	10 dB/ Ref 0 dB	Ch2	Invisible					

Trace List and Trace Settings

The main properties of all traces assigned to the diagram are displayed in the trace list in the upper part of the diagram.

Trc1	S11	dB Mag	10 dB/ Ref 0 dB	Ch1	Math	Mem5[Trc1]	S11	dB Mag	10 dB/ Ref 0 dB	Ch1
Trc5	S21	dB Mag	10 dB/ Ref 0 dB	Ch2	Invisible					

Each line in the trace list describes a single trace. The active trace is highlighted ("Trc5" in the example above). The lines are divided into several sections with the following contents (from left to right):

- The **trace name** appears in the first section. The default names for new traces are Trc<n> with n automatically selected. A "Mem..." at the beginning of the trace name indicates a memory trace (default naming). To change the trace names, open the "Trace Manager" from any trace name segment's context menu.
- The **measured quantity** (e.g. an S-parameter or a ratio) appears on a colored background. The source port for wave quantities and ratios is indicated in brackets.
- The **format** section shows how the measured data is presented in the graphical display. Use the context menu of the format section to change the format of the related trace.
- The next sections show the value of the vertical or radial diagram divisions ("Scale Div.") and the reference value ("Ref").
- The **channel** section shows the channel that each trace is assigned to. It is omitted if the all traces in the diagram are assigned to the same channel.
- The **type** section indicates "Invisible" if a trace is hidden and Math if the trace is a mathematical trace. "Gat" indicates that a time gate is active for the trace. Use the "Mem Math" and "Traces" tabs of the Trace softtool to display and hide data and memory traces, and to define mathematical traces.



- The respective section's context menu (except for the type section) provides access to the most common related tasks.
- If the size of the diagram is too small, some of the sections are hidden. Enlarge or maximize the diagram to display all sections.

Example:

The following context menu is assigned to the measured quantity section in the trace list:

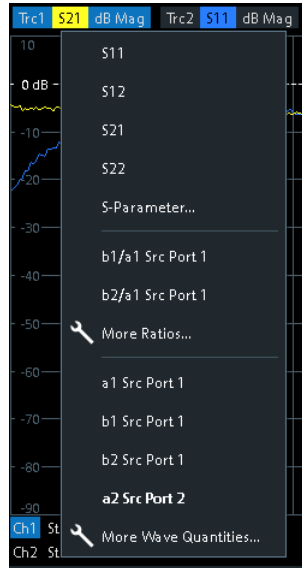

A label "Cal Off" appears at the end of the trace line if the system error correction no longer applies to the trace.

9.2.1.3 Markers

Markers are tools for numerical readout of measured data and for selecting points on the trace, or, in general, in the diagram area. A marker is displayed with a symbol (e.g. a triangle, a crossbar or a line) on the trace, which can be a data trace or a memory trace. At the same time, the coordinates are displayed in a marker info field or in a table. Each marker can be defined as a normal marker (M), reference marker (R), or delta marker (Δ).

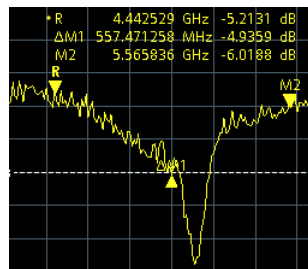

- A normal marker ("M1, M2...") determines the coordinates of a measurement point on the trace.
- The reference marker ("R") defines the reference value for all delta markers.
- A delta marker ("DeltaM1, DeltaM2...") indicates the coordinates relative to the reference marker.

A special set of markers M1 to M4 is provided for bandfilter search mode.

The most common tasks to be performed with markers can be achieved using the "Marker" menu functions:

- Determine the coordinates of a measurement point on the trace. In polar diagrams where no x-axis is displayed, markers can be used to retrieve the stimulus value of specific points.
- Determine the difference between two trace points or the relative measurement result ("Delta Mode").
- Convert a complex measurement result into other formats.

Markers also play an important role in performing the following advanced tasks:

- Change the sweep range and the diagram scale ("Marker Function").
- Search for specific points on the trace ("Marker Search", "Target Search", "Bandfilter").

Activating and Moving Markers

To activate a marker, either select the marker symbol itself or the corresponding line in the marker info field.

To move the active marker on the trace, use one of the following methods:

- Drag the marker symbol to the desired position (Cartesian diagrams only).
- Activate the "Markers" tab of the "Marker Settings" softtool ([Mkr]) and enter the related stimulus value numerically.
- Use the functions on the "Marker Search" softtool (hardkey [Mkr->]) to move the marker to a specific position.



If the marker position is adjusted using the roll key, the mouse or the cursor keys, it always remains within the sweep range. If set explicitly by entering a numeric value, the marker position can be outside the sweep range. In this case, the marker symbol is automatically positioned to the start or stop value of the sweep range, whichever is closer.

Marker Info Field

The coordinates of all markers defined in a diagram can be displayed in the info field, which by default is located in the upper right corner.

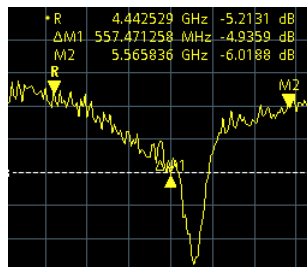

The info field contains the following information:

- "M1, M2..." denote the marker numbers. Markers are displayed with the same color as the associated trace.

- The marker coordinates are expressed in one of the marker formats selected via [Mkr] > "Marker Props" > "Marker Format". The formats of the markers assigned to a trace are independent of each other and of the trace format settings.
- The active marker has a dot placed in front of the marker line.
- "R" denotes the reference marker. A "Δ" sign placed in front of the marker line indicates that the marker is in delta mode.

Open the context menu of the marker info field to access frequently used marker settings.

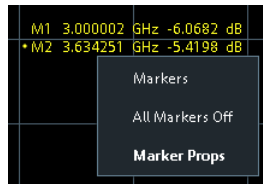

Customizing the marker info field

To change the position, appearance or contents of the marker info field, use one of the following methods:

- The info field can be moved to several positions in the upper and lower part of the active diagram. Drag & drop it to the desired position.
- To change the format of the active marker, select [TRACE] > "Marker" > "Marker Properties" > "Marker Format".
- To express the coordinates of the active marker relative to the reference marker, activate the delta mode [TRACE] > "Marker" > "Marker Properties" > "Delta Mode".



Info Table

If you wish to reserve the full diagram space for traces, you can drag & drop the marker info field to the info table.

M1	Trc1	5.130001	GHz	-15.6388	dB	Bandstop	Trc1	Ref to Max	Track
• M2	Trc1	4.718891	GHz	-7.3323	dB	Bandwidth		535.657892	MHz
M3	Trc1	5.254549	GHz	-7.3323	dB	Center		4.979523	GHz
M4	Trc1	4.979523	GHz	-9.5924	dB	Lower Edge		4.718891	GHz
						Upper Edge		5.254549	GHz
						Quality Factor (3dB)		9.296	U
						Loss		15.6388	dB

The info table is hidden by default. To display it, open the "Display Lines" softtool (hardkey [Display Lines]), activate its "Config" tab and select "Info Table" > "Show".

Marker Format

Marker values can be formatted according to the current trace format, according to the default marker format of the related trace ("Format" > "Dflt Marker Frmt"), or formatted individually ([Mkr] > "Marker Props" > "Marker Format").

The available marker formats are defined for all measured quantities and trace formats (see [Chapter 9.2.3.3, "Measured Quantities and Trace Formats"](#), on page 217). Essentially, a marker format is simply a conversion between points on a complex-valued trace (the raw measurement data) and the respective target format. This must be kept in mind when interpreting the results and physical units displayed.

The following table describes how a complex marker value $z = x + jy$ is converted. It makes use of the polar representation $z = x + jy = |z| e^{j\varphi(z)}$, where

$$|z| = (x^2 + y^2)^{1/2} \text{ and } \varphi(z) = \arctan(y/x)$$

Table 9-2: Marker formats

Marker Format	Description	Formula
Default	<ul style="list-style-type: none"> For an individual marker, this means that the marker is formatted according to the default marker format of the related trace. For a trace's default marker format, this means that the default format is (dynamically) adjusted according to the selected trace format. 	–
Lin Mag	Magnitude of z, unconverted	$ z = \sqrt{x^2 + y^2}$
dB Mag	Magnitude of z in dB	$ z = \sqrt{x^2 + y^2}$ dB Mag(z) = $20 * \log z $ dB
Phase	Phase of z	$\varphi(z) = \arctan(y/x)$
Delay	Group delay, neg. derivative of the phase response ¹⁾	$-\frac{d\varphi(z)}{d\omega}$, where ω denotes the stimulus frequency
Real	Real part of z	$\text{Re}(z) = x$
Imag	Imaginary part of z	$\text{Im}(z) = y$
SWR	(Voltage) Standing Wave Ratio	$\text{SWR} = (1 + z) / (1 - z)$
dB Mag Phase	Magnitude of z in dB and phase in two lines	$20 * \log z $ dB $\arctan(\text{Im}(z) / \text{Re}(z))$
Lin Mag Phase	Magnitude of z (unconverted) and phase in two lines	$ z \arctan(\text{Im}(z) / \text{Re}(z))$
Real Imag	Real and imaginary part of z in two lines	x y
R + j X or R + j X series ^{***)}	(Series) impedance: Unnormalized (series) resistance, reactance, and either inductance or capacitance, in three lines (Smith diagram)	R_s X_s L_s or C_s^{**}
R + j X parallel ^{***)}	Parallel impedance: Unnormalized parallel resistance, reactance, and either inductance or capacitance, in three lines (Smith diagram)	R_p X_p L_p or C_p^{**}
G + j B or G + j B series ^{***)}	(Series) admittance: Unnormalized (series) conductance, susceptance, and either inductance or capacitance, in three lines (Inverted Smith diagram)	G_s B_s L_s or C_s^{**}
G + j B parallel ^{***)}	Parallel admittance: Unnormalized parallel conductance, susceptance, and either inductance or capacitance in three lines (Inverted Smith diagram)	G_p B_p L_p or C_p^{**}
Imp Mag or IMP Mag series ^{***)}	Magnitude of (series) impedance ^{**)}	$ Z_s = (R_s^2 + X_s^2)^{1/2}$

Marker Format	Description	Formula
Imp Mag parallel ^{***})	Magnitude of parallel impedance ^{**})	$ Z_p = (R_p^2 + X_p^2)^{1/2}$
Adm Mag or Adm Mag series ^{***})	Magnitude of (series) admittance ^{**})	$ Y_s = (G_s^2 + B_s^2)^{1/2}$
Adm Mag parallel ^{***})	Magnitude of parallel admittance ^{**})	$ Y_p = (G_p^2 + B_p^2)^{1/2}$
Index	Index of the current sweep point	–

^{*}) The delay aperture is defined in the [Trace] > "Format" softtool.

^{**}) An impedance Z is represented as $Z = R + jX$, the corresponding admittance as $Y = 1/Z = G + jB$. For $X \geq 0$, we have an inductance $L = X/\omega$, for $X < 0$ we have a capacitance $C = 1/(\omega X)$, where ω denotes the stimulus frequency.

^{***}) Only available for transmission measurements (see [Chapter 9.3.3.1, "Converted Impedances"](#), on page 221)

Marker Coupling

It connects the markers of a set of traces.

Marker coupling allows you to compare different measurement results (assigned to different traces) at the same stimulus value. It connects the markers of a set of traces.

Marker coupling can be enabled:

- either for all traces in the active channel setup that have the same stimulus variable as the active trace
- or for all traces in a channel
- or for all traces in a diagram that have the same stimulus variable as the active trace

When marker coupling is enabled, the same markers are activated for all related traces: if a marker was active for some related trace, then it is activated for all related traces.

While marker coupling is active, the marker sets of the related traces are always kept in sync, i.e.:

- If a marker is added to (removed from) one of the related traces, it is also added to (removed from) the other related traces.
- If a marker is moved to a particular stimulus value for one of the related traces, then it is moved to this stimulus value for all related traces.
If the new stimulus value is outside a trace's sweep range, the marker value is invalid for this trace. The corresponding info field only displays the stimulus value.



Only one kind of marker coupling can be enabled. For instance it is not possible to couple markers per channel and per diagram at the same time.

Basic Marker Search Functions

The search functions are tools for searching measurement data according to specific criteria. A search consists of analyzing the measurement points of the current trace (or of a user-defined subrange termed the "Search Range") to find one of the following:

- Absolute or relative (local) maxima and minima (peak search).
- Trace points with a specific response value (target search).
- Trace segments with a shape that is characteristic for bandpass or bandstop filters (bandfilter search); see ["Bandfilter Search"](#) on page 204.

When the search is activated, the active marker is moved to the (next) point that meets the search criteria. If the trace contains no markers, a marker M1 is created and used for the search. The search result is displayed in the marker info field. If no search result can be found, the marker remains at its original position.

Some search functions can be activated repeatedly to find all possible search results. Moreover the VNA mode provides a "Tracking" mode where the search is repeated after each sweep.

Multiple Peak Search

Multiple peak search allows you to find multiple local minima/maxima at once. Markers 1 to 10 are assigned to the peaks detected from the start frequency towards the stop frequency. Multiple peak search uses its own search and tracking settings; search and tracking settings for standard marker search are ignored.

Bandfilter Search

In a bandfilter search, the R&S ZNL/ZNLE locates trace segments with a bandpass or bandstop shape and determines characteristic filter parameters.

Bandpass and bandstop regions can be described with the same parameter set:

- A bandpass region contains a local maximum around which the magnitude of the trace falls off by more than a specified value.
- A bandstop region contains a local minimum around which the magnitude of the trace increases by more than a specified value.

The VNA mode locates bandpass and bandstop regions and determines their position ("Center" frequency) and shape ("Bandwidth", "Lower Edge" and "Upper Edge", quality factor. For a meaningful definition of the bandwidth factor, the trace format must be "dB Mag".

Bandstop	Ref to Max	Track
Bandwidth	473.584123	MHz
Center	5.008818	GHz
Lower Edge	4.777620	GHz
Upper Edge	5.251205	GHz
Quality Factor (3dB)	10.576	U
Loss	14.9467	dB

The info field contains the following search results:

- "Bandwidth" is the n-dB bandwidth of the bandpass/bandstop region, where n is a selectable bandwidth factor. The bandwidth is equal to the difference between the lower and the upper band edge frequency.

- "Center" is calculated as the geometric or arithmetic mean of the lower band edge frequency f_{LBE} and the upper band edge frequency f_{UBE} :

$$f_{Center} = \sqrt{f_{LBE} * f_{UBE}} \quad (\text{geometric mean})$$

$$f_{Center} = 1/2 (f_{LBE} + f_{UBE}) \quad (\text{arithmetic mean})$$
 The arithmetic mean is always higher than the geometric mean. The values are close if the bandwidth is small compared to the geometric mean of the band edges.
- "Lower Edge" is the closest frequency below the maximum (or minimum), where the trace value is equal to the maximum (minimum) value minus (plus) n dB.
- "Upper Edge" is the closest frequency above the maximum (or minimum), where the trace value is equal to the maximum (minimum) value minus (plus) n dB.
- The "Quality Factor (3 dB)" is the ratio between the "Center" frequency and the 3-dB "Bandwidth"; it does not depend on the selected bandwidth factor.
- The "Quality Factor (BW)" is the ratio between the "Center" frequency and the "Bandwidth" displayed above. This result is available only if the selected bandwidth factor is different from 3 dB.
- "Loss" is the loss of the filter at its maximum (or minimum) and is equal to the response value of marker no. 1. For an ideal bandpass filter, the loss is zero (0 dB), for an ideal bandstop filter it is $-\infty$ dB.

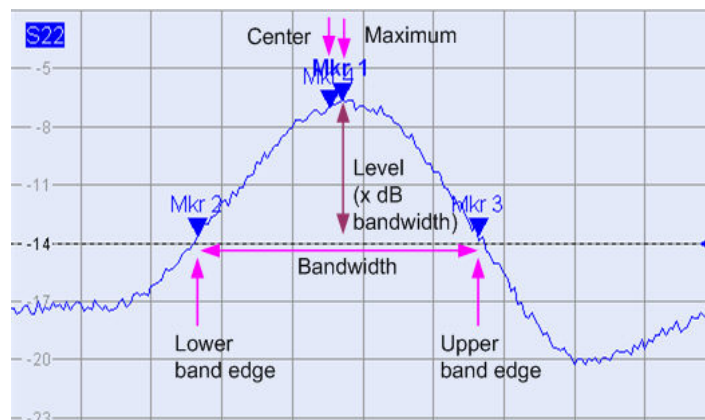

9.2.1.4 Channel List and Channel Settings

The main properties of all channels assigned to the traces in the diagram are displayed in the channel list below the diagram.

Ch1	Start	5 kHz	Pwr	-10 dBm	Bw	10 kHz	Stop	6 GHz
Ch2	Freq	1 GHz	Pwr	-10 dBm	Bw	10 kHz	Stop	201
Ch3	Freq	1 GHz	Pwr	-10 dBm	Bw	10 kHz	Stop	1 s
Ch4	Start	5 kHz	Pwr	-10 dBm	Bw	10 kHz	Stop	6 GHz
Trc4	Start	-1 ns	Time Domain				Stop	4 ns

Each line in the channel list describes a single channel. The channel of the active trace is highlighted. The lines are divided into several sections with the following contents (from left to right):

- The "Channel Name" appears in the first section. The default names for new channels are Ch<n> with an automatically assigned number <n>. If a time domain

transform is active, the R&S ZNL/ZNLE displays an additional line to indicate the stimulus range of the displayed time-domain trace.

Open the "Channel Manager" from the name segment's context menu to change the channel name.

- **Start** indicates the lowest value of the sweep variable (e.g. the lowest frequency measured), corresponding to the left edge of a Cartesian diagram.
- The **color legend** shows the display color of all traces assigned to the channel. The colors are different, so the number of colors is equal to the numbers of traces assigned to the channel.
- The values behind the color legend show the power of the internal signal source, and the measurement bandwidth ("BW").
- **Stop** indicates the highest value of the sweep variable (e.g. the highest frequency measured), corresponding to the right edge of a Cartesian diagram.



Open a segment's context menu to access common related tasks.

Example:

The following context menu is assigned to the channel name section:

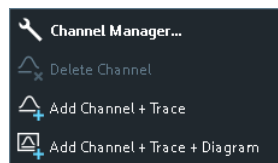

The settings in the context menus correspond to the most common functions in the "Channel" > "Channels" softtool tab (hardkey [Channel]), the "Stimulus" softtool (hardkey [Freq] and [Span]), the "Sweep" > "Sweep Params" softtool tab (hardkey [Sweep]) and the "Bw Avg Power" softtool (hardkey [Bw Avg Power]).

9.2.1.5 Context Menus

To provide access to the most common tasks and speed up the operation, the VNA mode offers context menus (right-click menus) for the following display elements:

- Diagram
- Marker info field
- Trace list (separate context menus for trace name section, measured quantity section, format section, scale section, and channel section)
- Channel list (separate context menus for channel name section, sweep range section, additional parameter section)

To open a context menu associated with a display element, tap and hold the element for some seconds. Right-click the display element if you are using a mouse.

Example:

The following context menu is assigned to the channel name section in the channel list:

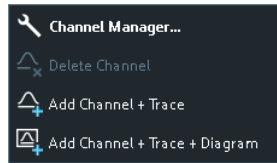

The functions of the context menu can also be called from the related softtool panels. Use whatever method is most convenient.

9.2.2 Dialogs

Dialogs provide groups of related settings and allow to make selections and enter data in an organized way. All softkeys with three dots behind their labeling (as in "Balanced Ports...") call up a dialog. The dialogs of the analyzer have an analogous structure and several common control elements.

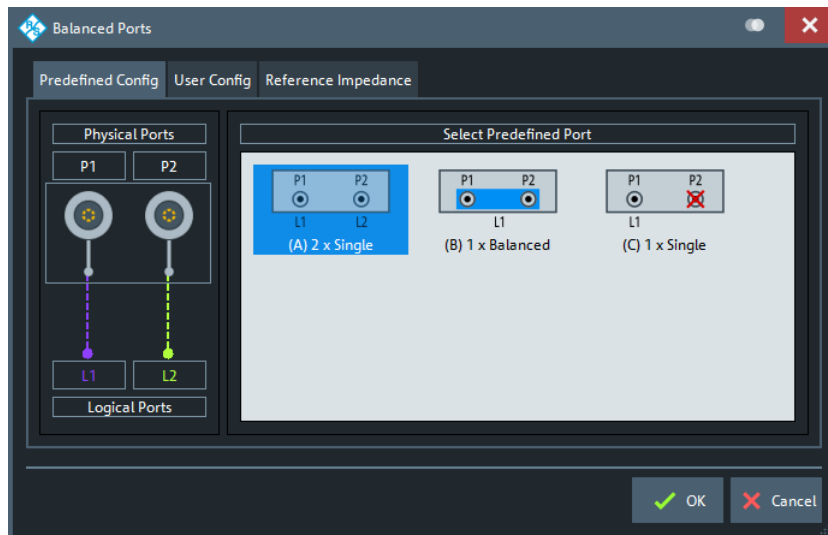

The title bar of each dialog contains some convenience functions:

- Use the "Dialog Transparency" function to make the display elements behind the dialog visible.

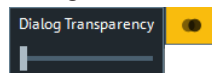

Note: The "Dialog Transparency" is a global setting, i.e. it applies to all dialogs.

- Use the  icon to create a screenshot of the dialog.

9.2.2.1 Immediate vs. Confirmed Settings

In some dialogs settings take effect immediately, so that the effect on the measurement is observable while the dialog is still open. This behavior is particularly useful when a

numeric value is incremented or decremented, or when display elements are added or removed.

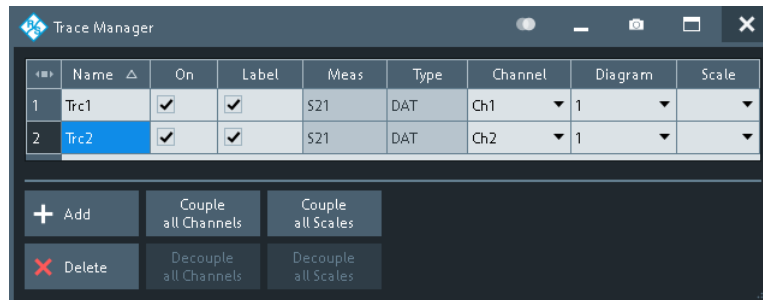

In most dialogs, however, it is possible to cancel an erroneous input before it takes effect. The settings in such dialogs must be confirmed explicitly.

The two types of dialogs are easy to distinguish:

- Dialogs with immediate settings provide a "Close" button but no "OK" button. Example: "Trace Manager" dialog
- Dialogs with confirmed settings provide both an "OK" button and a "Cancel" button. Example: "Balanced Ports" dialog



Immediate settings can be undone using the "Undo" toolbar icon.

9.2.2.2 Common Dialogs

Open Dialog

The "Open File" dialog is used to open various file types (cal kit data, limit lines, sweep segment lists, ...).

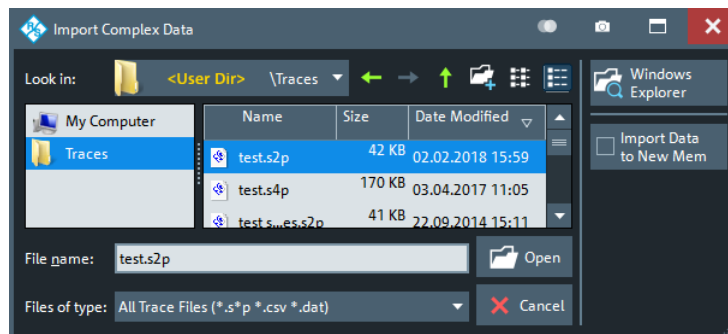

Depending on the context, the dialog is displayed with different caption, default directory ("Traces" in the above screenshot), and file type filters. Context-specific options ("Import Data to New Mem" in the above screenshot) are accessible via controls in the section below the "Windows Explorer" button.

- "Look in:" specifies the directory to be listed. The icons to the right of the pull-down list are provided for easy navigation in the file system (place the cursor on the icons to obtain "Whats this" help).

- "Windows Explorer" opens the selected directory in the Windows Explorer.
- "File name" specifies a filename to save the current data. The analyzer adds the extension in the "Files of type" field.
- "Files of type" filters the displayed files by type.
- "Open" opens selected file and closes the dialog.
- "Cancel" closes the dialog without opening a file.

Save Dialog

The "Save" dialog is used to store various data types (e.g. cal kit data, limit lines, sweep segment lists, ...).

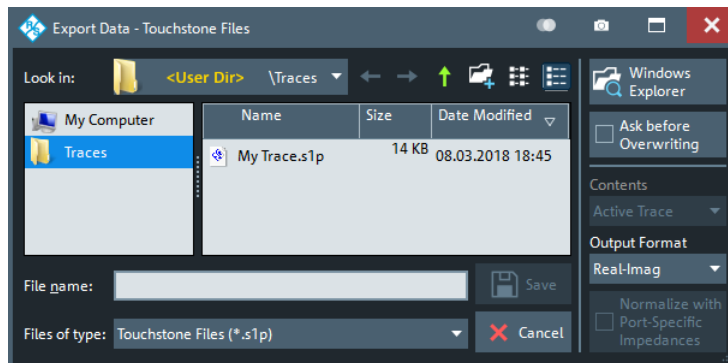

Depending on the context, the dialog is displayed with different caption, default directory ("Traces" in the above screenshot), and file types. Context-specific options (e.g. "Output Format" in the dialog above) are accessible via controls in the section below the "Ask Before Overwriting" toggle button.

- "Look in" specifies the drive and directory in which the data is stored. The icons to the right of the pull-down list are provided for easy navigation in the file system (place the cursor on the icons to obtain "Whats this" help).
- "File name" specifies a filename to save the current data. The analyzer adds the extension in the "Files of type" field.
- "Files of type" selects a particular file type for the created file.
- "Save" saves the data in the selected file and directory and closes the dialog.
- "Cancel" closes the dialog without saving the data.
- "Windows Explorer" opens the selected directory in Windows Explorer.
- If "Ask Before Overwriting" is enabled, overwriting an existing file has to be confirmed.

9.2.3 Trace Formats

A trace format defines how a trace is represented in a diagram.

The R&S ZNL/ZNLE supports the following trace formats:

- **Cartesian Trace Formats** "dB Mag", "Phase", "SWR", "Unwr Phase", "Lin Mag", "Log Mag", "Real", "Imag" and "Delay".
- Complex trace formats "Polar", "Smith" and "Inv Smith"



The VNA firmware allows arbitrary combinations of trace formats and measured quantities. However, to extract useful information from the measured data, it is important to select a trace format which is appropriate for the analysis of a particular measured quantity; see [Chapter 9.2.3.3, "Measured Quantities and Trace Formats"](#), on page 217.

9.2.3.1 Cartesian Trace Formats

Cartesian trace formats assign a scalar response to the stimulus value (frequency, power, or time). The response can be calculated from the measured quantity at the related stimulus value, but it can also be the result of some mathematical transformation of the original (unformatted) trace.

Diagram Representation

When a Cartesian trace is assigned to a diagram, the stimulus variable appears on the horizontal axis (x-axis), the response values appear on the vertical axis (y-axis).

Graph Scaling

- Except for the "Log Mag" format, the y-axis scale is always linear.
- The x-axis scaling depends on the sweep type of the channel to which the trace is assigned:
 - For sweep types "Lin Freq", "Power", "CW Mode" and "Time" it is scaled linearly.
 - For sweep type "Log Freq", it is scaled logarithmically.

The resulting linear or lin-log grid is plotted with the formatted trace.

The following examples show "dB Mag" Cartesian traces for the same measured quantity and sweep range, but with "Lin Freq" and "Log Freq" sweep types.

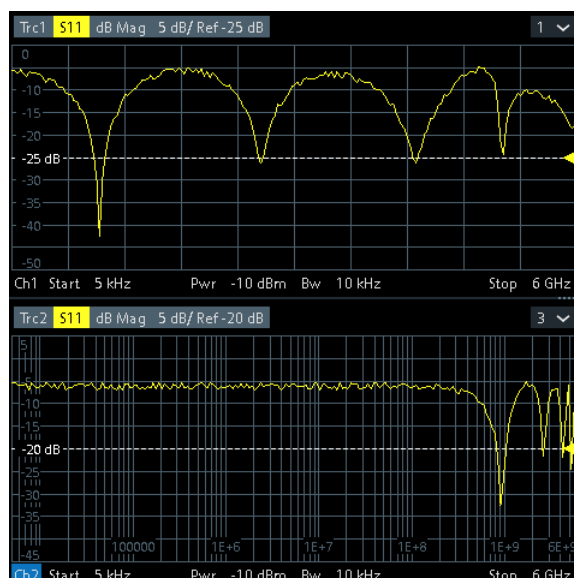

Figure 9-2: S11 trace in dB Mag format: sweep type Lin Freq (top) and Log Freq (bottom)

Conversion of Complex to Real Quantities

Among the measured quantities the R&S ZNL/ZNLE supports, only "Stability" factors and "Power Sensor" results are real. All other measured quantities are complex.



Power sensor measurements require option R&S FPL1-K9. This option is not available for the R&S ZNLE.

The following table shows how "real" response values are calculated from complex measurement values $z = x + j y$ (where x , y , z are functions of the sweep variable). The formulas also hold for real measurement values ($y = 0$).

Trace Format	Description	Formula
"dB Mag"	Magnitude of z in dB	$\text{dB Mag}(z) = 20 * \log z \text{ dB}$
"Phase"	Phase of z	$\varphi(z) = \arctan(y/x)$
"SWR"	(Voltage) Standing Wave Ratio	$\text{SWR} = (1 + z) / (1 - z)$
"Lin Mag"	Magnitude of z , unconverted	$ z = \text{sqrt}(x^2 + y^2)$
"Real"	Real part of z	$\text{Re}(z) = x$
"Imag"	Imaginary part of z	$\text{Im}(z) = y$
"Delay"	Group delay, neg. derivative of the phase response	$-\text{d} \varphi(z) / \text{d} \Omega \quad (\Omega = 2\pi * f)$



An extended range of formats and conversion formulas is available for markers. To convert any point on a trace, create a marker and select the appropriate marker format. Marker and trace formats can be selected independently.

9.2.3.2 Complex Trace Formats

Complex trace formats assign a complex response to the stimulus value (frequency, power, or time).

In diagrams, the response values are always represented as points in the two-dimensional complex plane:

- The complex 0 is located at the center of the diagram.
- The real part is drawn in horizontal direction, the imaginary part in vertical direction.

Result values for consecutive stimulus values are interconnected by straight lines, so the trace is represented as a polygonal chain in the complex plane.

The stimulus axis is not visible. However, the stimulus value for a given trace point can be displayed using a marker.

The difference between the different complex trace formats ([Polar](#), [Smith](#) and [Inv Smith](#)) is the coordinate system that is used for the representation of the response values and that is graphically overlaid to the formatted trace.

Polar

For "Polar" traces the complex response values are represented in polar coordinates: magnitude and phase.

In a diagram the grid lines overlaid to the trace correspond to points of equal magnitude and phase:

- Points with equal magnitude are located on circles around the complex 0 that is located at the center of the diagram.
- Points with the equal phase are located on straight lines originating at the center.

The following example shows a polar diagram with a marker used to display a pair of stimulus and response values.

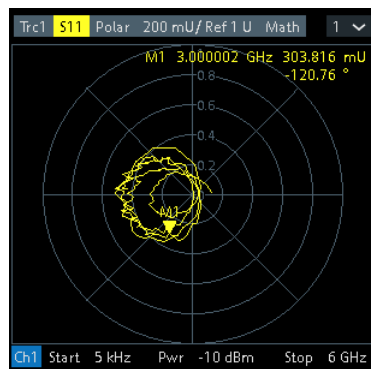

Example: Reflection coefficients in polar diagrams

If the measured quantity is a complex reflection coefficient (S_{11} , S_{22} etc.), then the center of the polar diagram corresponds to a perfect load Z_0 at the input test port of the DUT (no reflection, matched input). The outer circumference ($|S_{ij}| = 1$) represents a totally reflected signal.

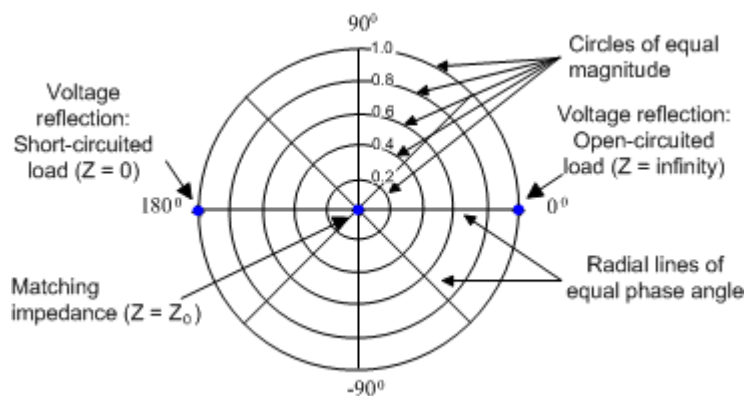

Examples for definite magnitudes and phase angles:

- The magnitude of the reflection coefficient of an open circuit ($Z = \text{infinity}$, $I = 0$) is one, its phase is zero.
- The magnitude of the reflection coefficient of a short circuit ($Z = 0$, $U = 0$) is one, its phase is -180 deg.

Smith

For "Smith" traces the response values are interpreted as reflection coefficients S_{ii} and represented in terms of their corresponding complex impedance $Z(S_{ii}) = R(S_{ii}) + j X(S_{ii})$.

In a diagram, the grid lines overlaid to a "Smith" trace correspond to points of equal resistance R and reactance X :

- Points with the same resistance are located on circles.
- Points with the same reactance produce arcs.

The following example shows a Smith chart with a marker used to display the stimulus value, the complex impedance $Z = R + j X$ and the equivalent inductance L .

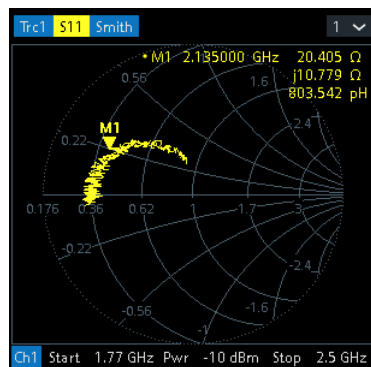

Smith chart construction

In a Smith chart, the impedance plane is reshaped so that the area with positive resistance is mapped into a unit circle.

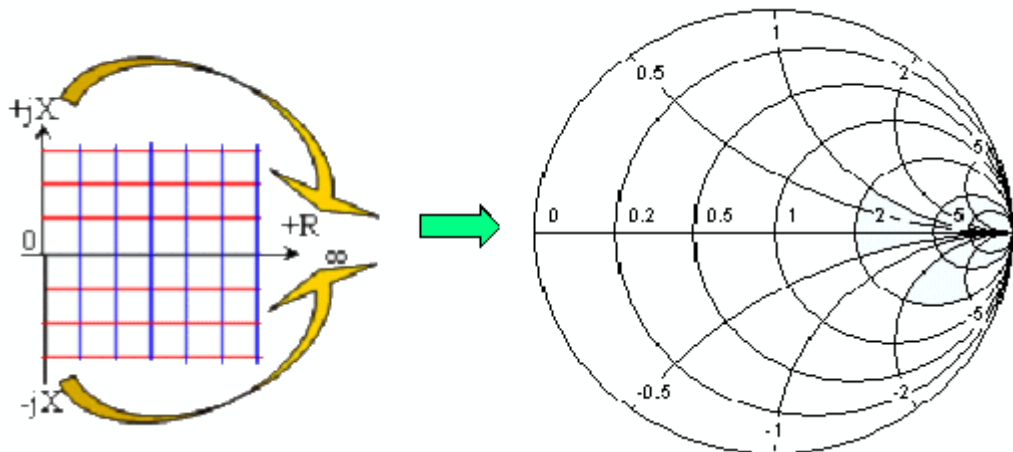

The basic properties of the Smith chart follow from this construction:

- The central horizontal axis corresponds to zero reactance (real impedance). The center of the diagram represents $Z/Z_0 = 1$ which is the reference impedance of the system (zero reflection). At the left and right intersection points between the horizontal axis and the outer circle, the impedance is zero (short) and infinity (open).
- The outer circle corresponds to zero resistance (purely imaginary impedance). Points outside the outer circle indicate an active component.

- The upper and lower half of the diagram correspond to positive (inductive) and negative (capacitive) reactive components of the impedance, respectively.

Example: Reflection coefficients in the Smith chart

If the measured quantity is a complex reflection coefficient Γ (e.g. S_{11} , S_{22}), then the unit Smith chart can be used to read the normalized impedance of the DUT. The coordinates in the normalized impedance plane and in the reflection coefficient plane are related as follows (see also: definition of matched-circuit (converted) impedances):

$$Z/Z_0 = \frac{1 + \Gamma}{1 - \Gamma}$$

From this equation, it is easy to relate the real and imaginary components of the complex resistance to the real and imaginary parts of Γ :

$$R = \text{Re}(Z/Z_0) = \frac{1 - \text{Re}(\Gamma)^2 - \text{Im}(\Gamma)^2}{[1 - \text{Re}(\Gamma)]^2 + \text{Im}(\Gamma)^2}$$

$$X = \text{Im}(Z/Z_0) = \frac{2 \text{Im}(\Gamma)}{[1 - \text{Re}(\Gamma)]^2 + \text{Im}(\Gamma)^2}$$

According to the two equations above, the graphical representation in a Smith chart has the following properties:

- Real reflection coefficients are mapped to real impedances (resistances).
- The center of the Γ plane ($\Gamma = 0$) is mapped to the reference impedance Z_0 , whereas the circle with $|\Gamma| = 1$ is mapped to the imaginary axis of the Z plane.
- The circles for the points of equal resistance are centered on the real axis and intersect at $Z = \text{infinity}$. The arcs for the points of equal reactance also belong to circles intersecting at $Z = \text{infinity}$ (open circuit point $(1, 0)$), centered on a straight vertical line.

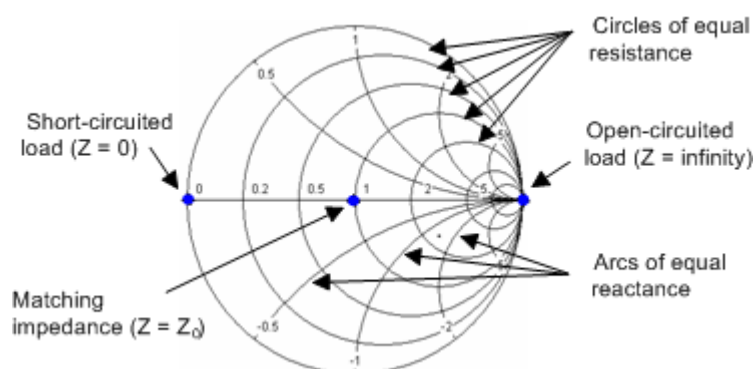

Examples for special points in the Smith chart:

- The magnitude of the reflection coefficient of an open circuit ($Z = \text{infinity}$, $\Gamma = 0$) is one, its phase is zero.
- The magnitude of the reflection coefficient of a short circuit ($Z = 0$, $\Gamma = 0$) is one, its phase is -180 deg.

Inv Smith

For "Inv Smith" formatted traces, the response values are interpreted as complex reflection coefficients S_{ii} and represented in terms of their corresponding complex admittance $Y(S_{ii}) = G(S_{ii}) + j B(S_{ii})$.

In a diagram, the grid lines overlaid to a "Smith" trace correspond to points of equal conductance G and susceptance B :

- Points with the same conductance are located on circles.
- Points with the same susceptance produce arcs.

The following example shows an inverted Smith chart with a marker used to display the stimulus value, the complex admittance $Y = G + j B$ and the equivalent inductance L .

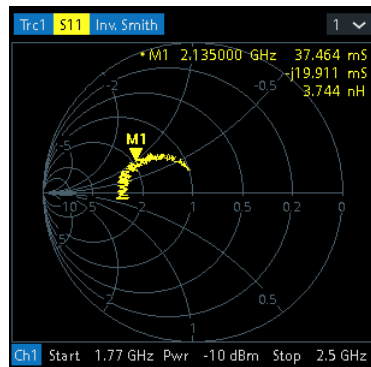

Inverted Smith chart construction

The inverted Smith chart is point-symmetric to the Smith chart:

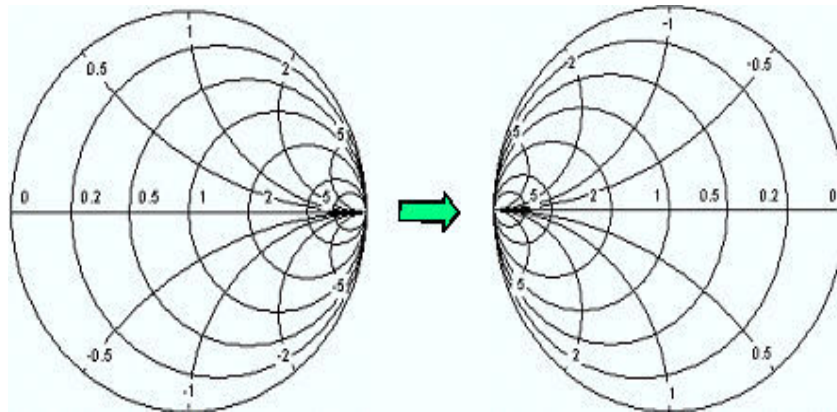

The basic properties of the inverted Smith chart follow from this construction:

- The central horizontal axis corresponds to zero susceptance (real admittance). The center of the diagram represents $Y/Y_0 = 1$, where Y_0 is the reference admittance of the system (zero reflection). At the left and right intersection points between the horizontal axis and the outer circle, the admittance is infinity (short) and zero (open).
- The outer circle corresponds to zero conductance (purely imaginary admittance). Points outside the outer circle indicate an active component.

- The upper and lower half of the diagram correspond to negative (inductive) and positive (capacitive) susceptive components of the admittance, respectively.

Example: Reflection coefficients in the inverted Smith chart

If the measured quantity is a complex reflection coefficient Γ (e.g. S_{11} , S_{22}), then the inverted Smith chart can be used to read the normalized admittance of the DUT. The coordinates in the normalized admittance plane and in the reflection coefficient plane are related as follows (see also: definition of matched-circuit (converted) admittances):

$$Y/Y_0 = \frac{1 - \Gamma}{1 + \Gamma}$$

From this equation, it is easy to relate the real and imaginary components of the complex admittance to the real and imaginary parts of Γ :

$$G = \text{Re}(Y/Y_0) = \frac{1 - \text{Re}(\Gamma)^2 - \text{Im}(\Gamma)^2}{[1 + \text{Re}(\Gamma)]^2 + \text{Im}(\Gamma)^2}$$

$$B = \text{Im}(Y/Y_0) = \frac{-2 \text{Im}(\Gamma)}{[1 + \text{Re}(\Gamma)]^2 + \text{Im}(\Gamma)^2}$$

According to the two equations above, the graphical representation in an inverted Smith chart has the following properties:

- Real reflection coefficients are mapped to real admittances (conductances).
- The center of the Γ plane ($\Gamma = 0$) is mapped to the reference admittance Y_0 , whereas the circle with $|\Gamma| = 1$ is mapped to the imaginary axis of the Y plane.
- The circles for the points of equal conductance are centered on the real axis and intersect at $Y = \text{infinity}$. The arcs for the points of equal susceptance also belong to circles intersecting at $Y = \text{infinity}$ (short circuit point $(-1, 0)$), centered on a straight vertical line.

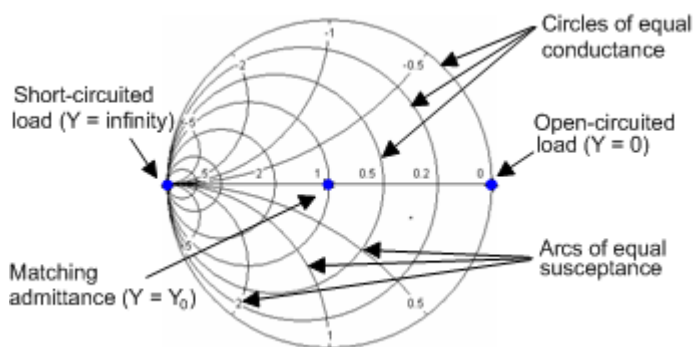

Examples for special points in the inverted Smith chart:

- The magnitude of the reflection coefficient of a short circuit ($Y = \text{infinity}$, $U = 0$) is one, its phase is -180 deg.
- The magnitude of the reflection coefficient of an open circuit ($Y = 0$, $I = 0$) is one, its phase is zero.

9.2.3.3 Measured Quantities and Trace Formats

The analyzer allows any combination of a display format and a measured quantity. The following rules can help to avoid inappropriate formats and find the format that is ideally suited to the measurement task.

- All formats are suitable for the analysis of reflection coefficients S_{ij} . The formats "SWR", "Smith" and "Inv Smith" lose their original meaning (standing wave ratio, normalized impedance or admittance) if they are used for transmission S-parameters, ratios and other quantities.
- For complex "Impedances", "Admittances", "Z-parameters", and "Y-parameters" generally a Cartesian format or the polar format is suitable.
- For the real valued [Stability Factors](#), one of the Cartesian formats "Lin Mag" or "Real" should be used. In complex formats, real numbers represent complex numbers with zero imaginary part.

The following table gives an overview of recommended display formats.

	Complex dimensionless quantities: S-parameters and ratios	Complex quantities with dimensions: Wave quantities, Z-parameters, Y-parameters, impedances, admittances	Real quantities: Stability Factors
Lin Mag	ON	ON (default for Z-parameters, Y-parameters, impedances, admittances)	ON (default)
dB Mag	ON (default)	ON (default for wave quantities)	–
Phase	ON	ON	–
Real	ON	ON	ON
Imag	ON	ON	–
Unwrapped Phase	ON	ON	–
Smith	ON (reflection coefficients S_{ij})	–	–
Polar	ON	–	–
Inverted Smith	ON (reflection coefficients S_{ij})	–	–
SWR	ON (reflection coefficients S_{ij})	–	–
Delay	ON (transmission coefficients S_{ij})	–	–

The default formats are activated automatically when the measured quantity is changed.

9.3 Measurement Results

This section gives an overview of the measurement results of the network analyzer and the meaning of the different measured quantities. All quantities can be selected in the "Meas" softtool (function key [Meas]).

9.3.1 S-Parameters

S-parameters are the basic measured quantities of a network analyzer. They describe how the DUT modifies a signal that is transmitted or reflected in forward or reverse direction. For a 2-port measurement, the signal flow is as follows.

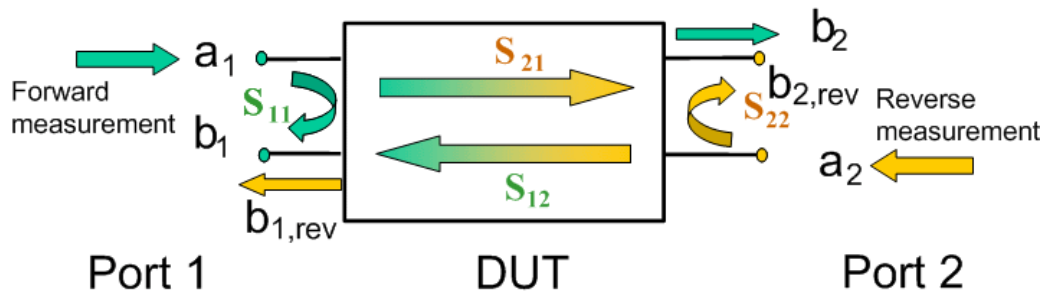

The figure above is sufficient for the definition of S-parameters but does not necessarily show the complete signal flow. In fact, if the source and load ports are not ideally matched, part of the transmitted waves are reflected off the receiver ports. An additional a_2 contribution occurs in forward measurements, and an a_1 contribution occurs in reverse measurements. The 7-term calibration types Txx take these additional contributions into account.

The scattering matrix links the incident waves a_1, a_2 to the outgoing waves b_1, b_2 according to the following linear equation:

$$\begin{bmatrix} b_1 \\ b_2 \end{bmatrix} = \begin{bmatrix} S_{11} & S_{12} \\ S_{21} & S_{22} \end{bmatrix} \begin{bmatrix} a_1 \\ a_2 \end{bmatrix}$$

Meaning of 2-port S-parameters

The four 2-port S-parameters can be interpreted as follows:

- S_{11} is the reflection coefficient of DUT port 1, i.e. the ratio between outgoing wave b_1 and incident wave a_1 in a forward measurement with matched DUT port 2:
 $S_{11} = b_1 / a_1$, if $|a_1| > 0$ and $a_2 = 0$
- S_{21} is the forward transmission coefficient, defined as the ratio between outgoing wave b_2 and incident wave a_1 in a forward measurement with matched DUT port 2:
 $S_{21} = b_2 / a_1$, if $|a_1| > 0$ and $a_2 = 0$
- S_{12} is the reverse transmission coefficient, defined as the ratio between outgoing wave b_1 and incident wave a_2 in a forward measurement with matched DUT port 1:
 $S_{12} = b_1 / a_2$, if $|a_2| > 0$ and $a_1 = 0$
- S_{22} is the reflection coefficient of port 2, i.e. the ratio between outgoing wave b_2 and incident wave a_2 in a forward measurement with matched DUT port 1:
 $S_{22} = b_2 / a_2$, if $|a_2| > 0$ and $a_1 = 0$

Meaning of squared amplitudes

The squared amplitudes of the incident and outgoing waves and of the matrix elements have a simple meaning:

Table 9-3: Squared S-parameters

$ a_i ^2$	Available incident power (= the power provided by a generator with a source impedance equal to the reference impedance Z_0) at DUT port $i=1,2$
$ b_i ^2$	Reflected power at DUT port $i=1,2$
$10 \log S_{ii} ^2 = 20 \log S_{ii} $	Reflection loss at DUT port $i=1,2$
$10 \log S_{21} ^2 = 20 \log S_{21} $	Insertion loss of forward transmission
$10 \log S_{12} ^2 = 20 \log S_{12} $	Insertion loss of reverse transmission

9.3.2 Reference Impedances

Changing the reference impedances of the analyzer ports is often referred to as renormalization of port impedances. Renormalization means that the measurement results measured at 50 Ω (75 Ω) are converted into results at arbitrary port impedance.

- Renormalization of the physical port impedances affects, e.g., S-parameters and wave quantities in "Power" representation.
- Renormalization of the balanced port impedances affects all measured quantities that the analyzer provides for balanced ports.

The default reference impedance of a physical port is equal to the reference impedance of the connector type assigned to the port (50 Ω or 75 Ω). It can be defined as a complex value. For balanced ports, it is possible to define separate complex reference impedances for differential and for common mode.

The default values for the balanced port reference impedances are derived from the default reference impedance of the physical analyzer ports ($Z_0 = 50 \Omega$):

- The default value for the differential mode is $Z_{0d} = 100 \Omega = 2 \cdot Z_0$.
- The default value for the common mode is $Z_{0c} = 25 \Omega = Z_0/2$

Renormalization can be based on two alternative waveguide circuit theories whose conversion formulas may yield different results if the reference impedance of at least one test port has a non-zero imaginary part.

Conversion formula for wave quantities and S-parameters

Renormalization transforms the "raw" S-matrix S_0 for the default reference impedances Z_{0i} (with physical port number index $i = 1, 2, \dots, n$) into a "renormalized" S-matrix S_1 for the modified reference impedances Z_{1i} . In terms of raw and renormalized wave quantities a_{0i} , b_{0i} and a_{1i} , b_{1i} , S_0 and S_1 are defined as follows:

$$\begin{pmatrix} b_{01} \\ b_{02} \\ \dots \\ b_{0n} \end{pmatrix} = S_0 \cdot \begin{pmatrix} a_{01} \\ a_{02} \\ \dots \\ a_{0n} \end{pmatrix}; \quad \begin{pmatrix} b_{11} \\ b_{12} \\ \dots \\ b_{1n} \end{pmatrix} = S_1 \cdot \begin{pmatrix} a_{11} \\ a_{12} \\ \dots \\ a_{1n} \end{pmatrix}.$$

The renormalized wave quantities (a_1 and b_1) and the S-matrix S_1 can be calculated from S_0 and the reference impedances Z_{0i} , Z_{1i} according to two alternative waveguide circuit theories.

1. Traveling waves

In the model of Marks and Williams ("A General Waveguide Circuit Theory"), the wave quantities a and b are transformed as follows:

$$\begin{pmatrix} a_{1i} \\ b_{1i} \end{pmatrix} = \frac{1}{2Z_{0i}} \begin{vmatrix} Z_{0i} & \\ & Z_{1i} \end{vmatrix} \sqrt{\frac{\operatorname{Re}(Z_{1i})}{\operatorname{Re}(Z_{0i})}} \cdot \begin{pmatrix} Z_{0i} + Z_{1i} & Z_{0i} - Z_{1i} \\ Z_{0i} - Z_{1i} & Z_{0i} + Z_{1i} \end{pmatrix} \cdot \begin{pmatrix} a_{0i} \\ b_{0i} \end{pmatrix}$$

The renormalized S-matrix S_1 is calculated as:

$$S_1 = P^{-1}(S_0 - \gamma)(E - \gamma S_0)^{-1} P$$

with the unit matrix E and two additional matrices with the elements

$$\gamma_{ii} = \frac{Z_{1i} - Z_{0i}}{Z_{1i} + Z_{0i}}$$

$$P_{ii} = \frac{Z_{0i}}{Z_{0i} + Z_{1i}} \begin{vmatrix} Z_{1i} & \\ & Z_{0i} \end{vmatrix} \sqrt{\frac{\operatorname{Re}(Z_{0i})}{\operatorname{Re}(Z_{1i})}}$$

2. Power waves

In the model of Kurokawa ("Power Waves and the Scattering Matrix"), the wave quantities a and b are transformed as follows:

$$\begin{pmatrix} a_{1i} \\ b_{1i} \end{pmatrix} = \frac{1}{2\sqrt{\operatorname{Re}(Z_{0i})\operatorname{Re}(Z_{1i})}} \cdot \begin{pmatrix} \overline{Z_{0i}} + Z_{1i} & Z_{0i} - \overline{Z_{1i}} \\ \overline{Z_{0i}} - \overline{Z_{1i}} & Z_{0i} + \overline{Z_{1i}} \end{pmatrix} \cdot \begin{pmatrix} a_{0i} \\ b_{0i} \end{pmatrix}$$

The renormalized S-matrix S_1 is calculated as:

$$S_1 = A^{-1}(S_0 - \overline{\Gamma})(E - \Gamma S_0)^{-1} \overline{A}$$

with the unit matrix E and two additional matrices with the elements

$$\Gamma_{ii} = \frac{Z_{1i} - Z_{0i}}{Z_{1i} + Z_{0i}}$$

$$A_{ii} = \frac{1 - \overline{\Gamma_{ii}}}{|1 - \Gamma_{ii}|} \sqrt{|1 - \Gamma_{ii}\overline{\Gamma_{ii}}|}$$

9.3.3 Impedance Parameters

An impedance is the complex ratio between a voltage and a current. The analyzer provides two independent sets of impedance parameters:

- Converted impedances (each impedance parameter is obtained from a single S-parameter)
- Z-parameters (complete description of an n-port DUT)

9.3.3.1 Converted Impedances

The converted impedance parameters Z_{ij} ($1 \leq i, j \leq n$) describe the input impedances of an n-port DUT with fully matched outputs. The analyzer converts a single measured S-parameter S_{ij} to determine the corresponding converted impedance, under the assumption that each of the other ports is terminated with its respective reference impedance Z_{0k} (matched-circuit parameters). As a result, converted impedances cannot completely describe general n-port DUTs.

The [Converted Admittances](#) are defined as the inverse of the converted impedances.

Reflection Impedance

The converted impedance Z_{ii} ($1 \leq i \leq n$) describes the input impedance at port i of the DUT.

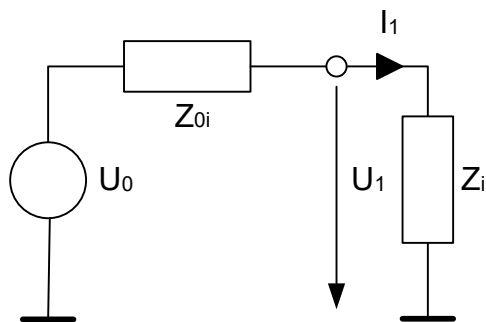

Example:

For a 2-port DUT that is terminated at its output with the reference impedance Z_{02} , Z_{11} is the input impedance (matched-circuit impedance measured in a forward reflection measurement).

A converted impedance Z_{11} completely describes a one-port DUT.

The calculation formula of the converted reflection impedances Z_{ii} depends on the waveguide circuit theory according to which [Reference Impedances](#) are calculated.

Table 9-4: Calculation of Converted Reflection Impedances

Traveling Waves	Power Waves
$Z_{ii} = Z_{0i} \frac{1 + S_{ii}}{1 - S_{ii}}$	$Z_{ii} = \frac{\overline{Z_{0i}} + S_{ii} Z_{0i}}{1 - S_{ii}}$

Series Transmission Impedance

A two-port transmission parameter Z_{ij} ($i \neq j$) can describe a pure serial impedance between the two ports.

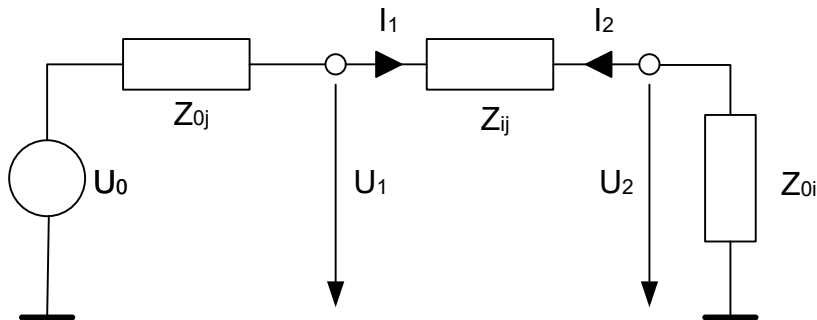

The calculation formula of a converted serial transmission impedance Z_{ij} depends on the waveguide circuit theory according to which [Reference Impedances](#) are calculated.

Table 9-5: Calculation of Converted Series Transmission Impedances

Traveling Waves	Power Waves
$Z = 2e^{j\varphi(Z_{0i})} \sqrt{\frac{\text{Re}(Z_{0i})}{\text{Re}(Z_{0j})}} \frac{ Z_{0j} }{S_{ij}} - (Z_{0i} + Z_{0j})$	$Z = 2 \text{sgn}(\text{Re}(Z_{0i})) \frac{\sqrt{ \text{Re}(Z_{0i})\text{Re}(Z_{0j}) }}{S_{ij}} - (Z_{0i} + Z_{0j})$

Parallel Transmission Impedance

A two-port transmission parameter Z_{ij} ($i \neq j$) can also describe a parallel impedance between the two ports.

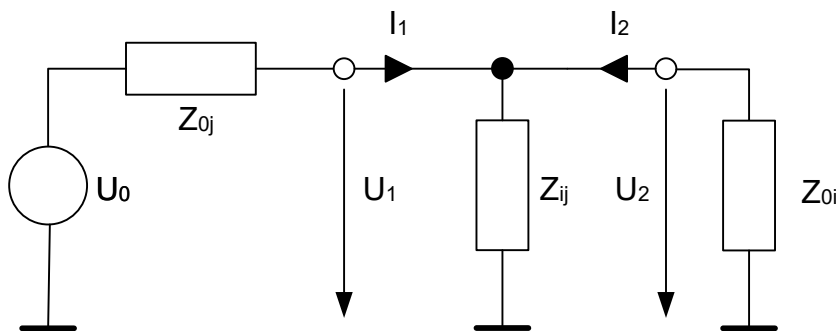

The calculation formula of a converted parallel transmission impedance Z_{ij} depends on the waveguide circuit theory according to which [Reference Impedances](#) are calculated.

Table 9-6: Calculation of Converted Parallel Transmission Impedances

Traveling Waves	Power Waves
$Z = \frac{Z_{0i}Z_{0j}S_{ij}}{2 \left(Z_{0i} \left \frac{Z_{0j}}{Z_{0i}} \right \sqrt{\left \frac{\text{Re}(Z_{0i})}{\text{Re}(Z_{0j})} \right } - S_{ij} \frac{Z_{0i}+Z_{0j}}{2} \right)}$	$Z = \frac{Z_{0j}S_{ij}}{\sqrt{\left \frac{\text{Re}(Z_{0j})}{\text{Re}(Z_{0i})} \right } (1 + e^{-2\varphi(Z_{0i})}) - S_{ij} \left(1 + \frac{Z_{0j}}{Z_{0i}} \right)}$

Shunt-thru Measurements

The shunt-thru method is used for measuring very low impedances. A typical application are measurements on power distribution network (PDN) components, such as bypass capacitors and DC-DC converters.

The R&S ZNL/ZNLE uses S_{ij} ($i \neq j$) to calculate the DUT impedance using the formula:

$$Z = \frac{50 \Omega}{2} \cdot \frac{S_{ij}}{1 - S_{ij}}$$

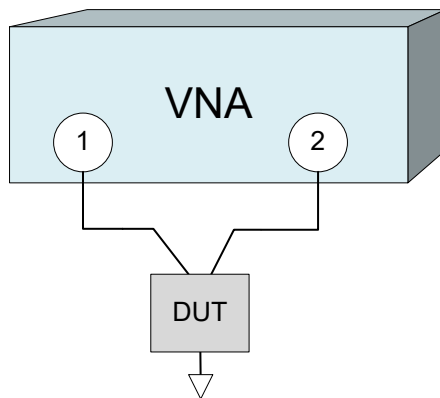

9.3.3.2 Z-Parameters

The Z-parameters describe the impedances of a DUT with open output ports (impedance = 0). The analyzer provides the full set of Z-parameters including the transfer impedances (i.e. the complete $n \times n$ Z-matrix for an n port DUT).

This means that Z-parameters can be used as an alternative to S-parameters (or Y-parameters) to characterize a linear n -port network completely.

2-Port Z-Parameters

In analogy to S-parameters, Z-parameters are expressed as Z_{ij} , where i denotes the measured and j the stimulated port.

The Z-parameters for a two-port are based on a circuit model that can be expressed with two linear equations:

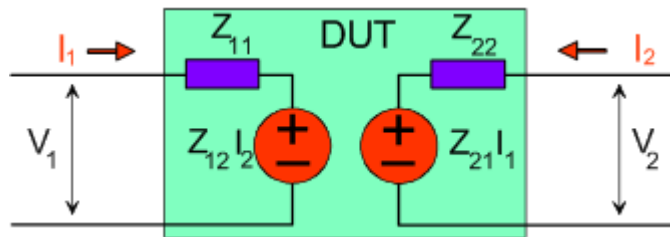

$$V_1 = Z_{11}I_1 + Z_{12}I_2$$

$$V_2 = Z_{21}I_1 + Z_{22}I_2$$

Meaning of Z-parameters

The four 2-port Z-parameters can be interpreted as follows:

- Z_{11} is the input impedance, defined as the ratio of the voltage V_1 to the current I_1 , measured at port 1 (forward measurement with open output, $I_2 = 0$).
- Z_{21} is the forward transfer impedance, defined as the ratio of the voltage V_2 to the current I_1 (forward measurement with open output, $I_2 = 0$).
- Z_{12} is the reverse transfer impedance, defined as the ratio of the voltage V_1 to the current I_2 (reverse measurement with open input, $I_1 = 0$).
- Z_{22} is the output impedance, defined as the ratio of the voltage V_2 to the current I_2 , measured at port 2 (reverse measurement with open input, $I_1 = 0$).

Z-parameters can be easily extended to describe circuits with more than two ports or several modes of propagation.

9.3.4 Admittance Parameters

An admittance is the complex ratio between a current and a voltage. The analyzer provides two independent sets of admittance parameters:

- Converted admittances (each admittance parameter is obtained from a single S-parameter)
- Y-parameters (complete description of the n-port DUT)

9.3.4.1 Converted Admittances

The converted admittance parameters describe the input admittances of a DUT with fully matched outputs. The converted admittances are the inverse of the [Converted Impedances](#).

9.3.4.2 Y-Parameters

The Y-parameters describe the admittances of a DUT with output ports terminated in a short circuit (voltage = 0). The analyzer provides the full set of Y-parameters including the transfer admittances (i.e. the complete $n \times n$ Y-matrix for an n port DUT).

This means that Y-parameters can be used as an alternative to S-parameters (or Z-parameters) to characterize a linear n-port network completely.

2-Port Y-Parameters

In analogy to S-parameters, Y-parameters are expressed as $Y_{\langle out \rangle \langle in \rangle}$, where $\langle out \rangle$ and $\langle in \rangle$ denote the output and input port numbers of the DUT. In analogy to Z-parameters, the Y-parameters for a two-port are based on a circuit model that can be expressed with two linear equations:

$$I_1 = Y_{11}V_1 + Y_{12}V_2$$

$$I_2 = Y_{21}V_1 + Y_{22}V_2$$

Meaning of Y-parameters

The four 2-port Y-parameters can be interpreted as follows:

- Y_{11} is the input admittance, defined as the ratio of the current I_1 to the voltage V_1 , measured at port 1 (forward measurement with output terminated in a short circuit, $V_2 = 0$).
- Y_{21} is the forward transfer admittance, defined as the ratio of the current I_2 to the voltage V_1 (forward measurement with output terminated in a short circuit, $V_2 = 0$).
- Y_{12} is the reverse transfer admittance, defined as the ratio of the current I_1 to the voltage V_2 (reverse measurement with input terminated in a short circuit, $V_1 = 0$).
- Y_{22} is the output admittance, defined as the ratio of the current I_2 to the voltage V_2 , measured at port 2 (reverse measurement with input terminated in a short circuit, $V_1 = 0$).

Y-parameters can be easily extended to describe circuits with more than two ports or several modes of propagation.

9.3.5 Wave Quantities and Ratios

The elements of the S-, Z- and Y-matrices represent fixed ratios of complex wave amplitudes. As long as the assumption of linearity holds, the S-, Z- and Y-parameters are independent of the source power.

The network analyzer provides two additional sets of measurement parameters which have an unambiguous meaning even if the DUT is measured outside its linear range:

- *Wave quantities* provide the power of any of the transmitted or received waves.
- *Ratios* provide the complex ratio of any combination of transmitted or received wave quantities.



In contrast to S-, Z- and Y-parameters, wave quantities and ratios are not system-error corrected.

9.3.5.1 Wave Quantities

A wave quantity measurement provides the power of any of the transmitted or received waves. The power can be displayed in voltage units (e.g. V or dBmV) or equivalent power units (e.g. W or dBm).



Examples for using wave quantities

The wave quantities provide the power at the different receive ports of the analyzer. This is different from an S-parameter measurement, where the absolute power of a linear device is canceled. Wave quantities are therefore suitable for the following measurement tasks:

- Analysis of nonlinearities of the DUT.
- Use of the analyzer as a selective power meter.

The notation for wave quantities is as follows:

- "a_i Src Port j" denotes the wave incoming at DUT port i, when DUT port j is stimulated.
a_i is detected at the reference receiver of the VNA port connected to DUT port i.
- "b_i Src Port j" denotes the wave outgoing at DUT port i, when DUT port j is stimulated.
b_i is detected at the measurement receiver of the VNA port connected to DUT port i.

In a standard forward S-parameter measurement, a₁ Src Port 1 is the incident wave and b₁ Src Port 1 is the reflected wave at DUT port 1.

9.3.5.2 Ratios

A ratio measurement provides the complex ratio of any combination of transmitted or received wave amplitudes. Ratios complement the S-parameter measurements, where only ratios of the form b_i/a_j (ratios between outgoing and incoming waves at the DUT ports) are considered.



Examples for using ratios

A measurement of ratios is particularly suitable for the following test scenarios:

- The test setup or some of its components (e.g. active components or non-reciprocal devices) do not allow a system error correction so that a complete S-parameter measurement is not possible.
- The test setup contains frequency-converting components so that the transmitted and the received waves are at different frequencies.
- A ratio of two arbitrary waves that is not an element of the S-matrix (e.g. a ratio of the form a_i/a_j) is needed.

The notation for ratios is similar to the notation for wave quantities (see [Chapter 9.3.5.1, "Wave Quantities"](#), on page 226). Given a source port k , any ratio between wave quantities " a_i Src Port k " and " b_j Src Port k " can be measured.

Examples:

- " b_2/a_1 Src Port 1" is the ratio of the outgoing wave at DUT port 2 and the incident wave at DUT port 1 (i.e. DUT port 1 is stimulated). This corresponds to the forward transmission coefficient S_{21} .
- " b_1/a_1 Src Port 1" is the ratio of the outgoing wave at DUT port 1 and the incident wave at DUT port 1 (i.e. DUT port 1 is stimulated). This corresponds to the forward reflection coefficient S_{11} .

9.3.6 Unbalance-Balance Conversion

Unbalance-balance conversion is the simulation of one or more unbalance-balance transformers (baluns) integrated in the measurement circuit. It converts the DUT ports from an unbalanced state into a balanced state and virtually separates the differential and common mode signals. The analyzer measures the unbalanced state but converts the results and calculates mixed mode parameters, e.g. mixed mode S-parameters. No physical transformer is needed.

To perform balanced measurements, a pair of physical analyzer ports is combined to form a logical port. The balanced port of the DUT is directly connected to the analyzer ports. For a two-port analyzer, a single balanced port can be defined.

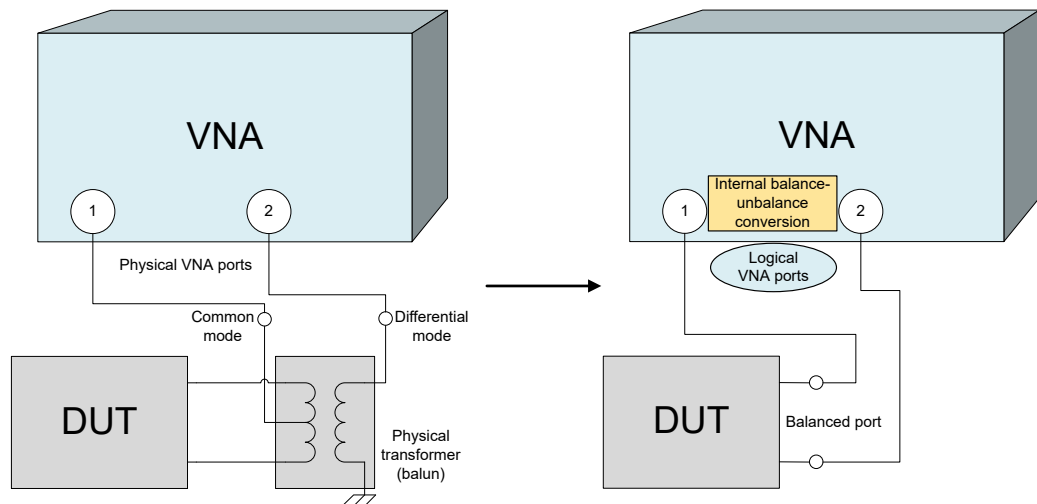

Unbalance-balance conversion avoids the disadvantages of real transformers:

- There is no need to fabricate test fixtures with integrated baluns for each type of DUT.
- The measurement is not impaired by the non-ideal characteristics of the balun (e.g. error tolerances, limited frequency range).
- Calibration can be performed at the DUT's ports. If necessary (e.g. to compensate for the effect of a test fixture), it is possible to shift the calibration plane using length offset parameters.

- Differential and common mode parameters can be evaluated with a single test setup.

9.3.6.1 Balanced Port Configurations

Defining a balanced logical port requires two physical ports.

You can combine the two physical VNA ports to a single balanced (logical) port and then assign arbitrary, independent reference impedance values to its differential and common mode.

Example:

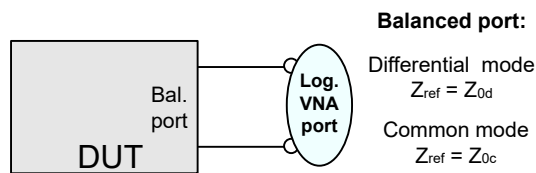

The "Balanced Ports" dialog allows you to switch to balanced operation and to define the reference impedances the differential and common mode.

Depending on the test setup, the analyzer provides different types of mixed mode parameters; refer to the following sections for details.

9.3.6.2 Mixed Mode Parameters

Mixed mode parameters are an extension of normal mode parameters (e.g. S-parameters, impedances and admittances) for balanced measurements. The analyzer can measure mixed mode parameters once a balanced port configuration is selected.

Mixed mode parameters are used to distinguish the following three port modes:

- s: Single-ended (for unbalanced ports)
- d: Differential mode (for balanced ports)
- c: Common mode (for balanced ports)

The notation of a general S-parameter is $S_{<out><min><out><in>}$, where <out> and <min> denote the output and input port modes, <out> and <in> denote the output and input port numbers.

Meaning of 2-port mixed mode S-parameters

The mixed mode 2-port S-parameters can be interpreted as follows:

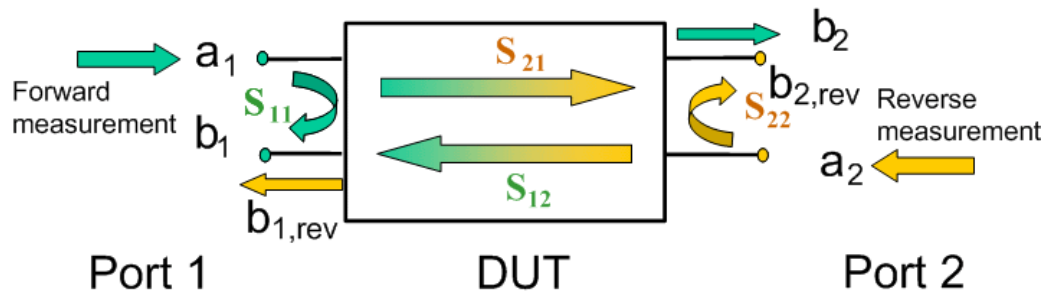

- $S_{\langle \text{mout} \rangle \langle \text{min} \rangle 11}$ is the mixed mode input reflection coefficient, defined as the ratio of the wave quantities b_1 (mode mout) to a_1 (mode min), measured at PORT 1 (forward measurement with matched output and $a_2 = 0$).
- $S_{\langle \text{mout} \rangle \langle \text{min} \rangle 21}$ is the mixed mode forward transmission coefficient, defined as the ratio of the wave quantities b_2 (mode mout) to a_1 (mode min) (forward measurement with matched output and $a_2 = 0$).
- $S_{\langle \text{mout} \rangle \langle \text{min} \rangle 12}$ is the mixed mode reverse transmission coefficient, defined as the ratio of the wave quantities b_1 (mode mout) (reverse measurement with matched input, b_1' in the figure above and $a_1 = 0$) to a_2 (mode min).
- $S_{\langle \text{mout} \rangle \langle \text{min} \rangle 22}$ is the mixed mode output reflection coefficient, defined as the ratio of the wave quantities b_2 (mode mout) (reverse measurement with matched input, b_2' in the figure above and $a_1 = 0$) to a_2 (mode min), measured at PORT 2.

If $\langle \text{mout} \rangle$ is different from $\langle \text{min} \rangle$, the S-parameters are called mode conversion factors.

Mixed Mode Parameters for Different Test Setups

Which types of mixed mode parameter are available depends on the measured device and the port configuration of the analyzer. The following examples of mixed mode parameters can be measured with a 2-port analyzer.

1. DUT with only single-ended ports: No balanced port definition necessary, the analyzer provides single-ended multiport parameters.
2. DUT with one balanced port: Only reflection and mode conversion measurements with differential and common mode parameters.

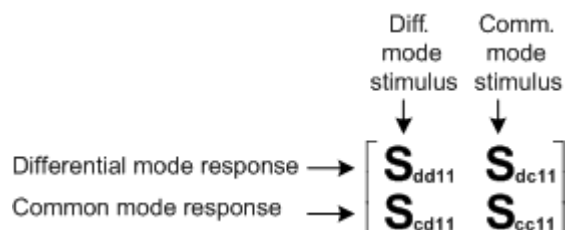

9.3.7 Stability Factors

The stability factors K , μ_1 and μ_2 are real functions of the (complex) S-parameters, defined as follows:

$$K := \frac{1 - |S_{11}|^2 - |S_{22}|^2 + |S_{11} \cdot S_{22} - S_{12} \cdot S_{21}|^2}{2 \cdot |S_{12} \cdot S_{21}|}$$

$$\mu_1 := \frac{1 - |S_{11}|^2}{|S_{22} - \overline{S_{11}} \cdot (S_{11} \cdot S_{22} - S_{12} \cdot S_{21})| + |S_{12} \cdot S_{21}|}$$

$$\mu_2 := \frac{1 - |S_{22}|^2}{|S_{11} - \overline{S_{22}} \cdot (S_{11} \cdot S_{22} - S_{12} \cdot S_{21})| + |S_{12} \cdot S_{21}|}$$

where \bar{S} denotes the complex conjugate of S.

Stability factors are calculated as functions of the frequency or another stimulus parameter. They provide criteria for linear stability of two-ports such as amplifiers. A linear circuit is said to be unconditionally stable if no combination of passive source or load can cause the circuit to oscillate.

- The K-factor provides a necessary condition for unconditional stability: A circuit is unconditionally stable if $K > 1$ and an additional condition is met. The additional condition can be tested with the stability factors μ_1 and μ_2 .
- The μ_1 and μ_2 factors both provide a necessary and sufficient condition for unconditional stability: The conditions $\mu_1 > 1$ or $\mu_2 > 1$ are both equivalent to unconditional stability. This means that μ_1 and μ_2 provide direct insight into the degree of stability or potential instability of linear circuits.

References: Marion Lee Edwards and Jeffrey H. Sinsky, "A New Criterion for Linear 2-Port Stability Using a Single Geometrically Derived Parameter", IEEE Trans. MTT, vol. 40, No. 12, pp. 2303-2311, Dec. 1992.

9.3.8 Delay, Aperture, Electrical Length

The group delay τ_g represents the propagation time of wave through a device. τ_g is a real quantity and is calculated as the negative of the derivative of its phase response. A non-dispersive DUT shows a linear phase response, which produces a constant delay (a constant ratio of phase difference to frequency difference).

The group delay is defined as:

$$\tau_g = -\frac{d\phi_{rad}}{d\omega} = -\frac{d\phi_{deg}}{360^\circ df}$$

where

Φ_{rad} , Φ_{deg} = phase response in radians or degrees

ω = angular velocity in radians/s

f = frequency in Hz

In practice, the analyzer calculates an approximation to the derivative of the phase response, taking a small frequency interval Δf and determining the corresponding phase change $\Delta\Phi$. The delay is thus computed as:

$$\tau_{g,meas} = -\frac{\Delta\phi_{deg}}{360^\circ \cdot \Delta f}$$

The aperture Δf must be adjusted to the conditions of the measurement.

If the delay is constant over the considered frequency range (non-dispersive DUT, e.g. a cable), then τ_g and $\tau_{g,meas}$ are identical and:

$$\tau_g = \frac{d(360^\circ f \cdot \Delta t)}{360^\circ d f} = \Delta t = \frac{L_{mech} \cdot \sqrt{\epsilon}}{c}$$

where Δt is the propagation time of the wave across the DUT, which often can be expressed in terms of its mechanical length L_{mech} , the permittivity ϵ , and the velocity of light c . The product $L_{mech} \cdot \sqrt{\epsilon}$ is termed the electrical length of the DUT and is always larger or equal than the mechanical length ($\epsilon > 1$ for all dielectrics and $\epsilon = 1$ for the vacuum).

9.4 Operations on Traces

The R&S ZNL/ZNLE can perform more complex operations on the measured traces. Some of the operations, e.g. the time domain transform, require additional software options; see [Chapter 9.7, "Optional Extensions and Accessories"](#), on page 281.

The R&S ZNL/ZNLE can also check whether the measured values comply with specified limits and export trace data, using different file formats.

9.4.1 Limit Check

A limit line restricts the allowed range for some or all points of a trace, i.e. for a certain range of stimulus values. Typically, limit lines are used to check whether a DUT conforms to the rated specifications (conformance testing).

- An upper limit line defines the maximum allowed values for the related stimulus range.
- A lower limit line defines the minimum allowed values for the related stimulus range.
- A ripple limit defines the maximum difference between the largest and the smallest response value for the related stimulus range. A ripple limit test is suitable, e.g., to check whether the passband ripple of a filter is within acceptable limits, irrespective of the actual transmitted power in the passband.
- A circle limit defines the acceptable values as a circular area within a complex diagram.

A limit check consists of comparing the measurement results to the limit lines and display a pass/fail indication. An acoustic warning and a TTL signal at the Aux. Port on the rear panel (for test automation) can be generated in addition if a limit is violated.

Upper and lower limit lines are both defined as a combination of segments with a linear or logarithmic dependence between the measured quantity and the sweep variable (stimulus variable). Similar to this segmentation, ripple limits can be defined in several ranges. The limit lines (except circle limits) can be stored to a file and recalled. Data or memory traces can be used to define the segments of an upper or lower limit line. Moreover it is possible to modify the upper and lower limit lines globally by adding an offset to the stimulus or response values.

9.4.1.1 Rules for Limit Line Definition

The analyzer places few restrictions on the definition of limit line segments.

The following rules ensure a maximum of flexibility:

- Segments do not have to be sorted in ascending or descending order (e.g. the "Start Stimulus" value of segment no. n does not have to be smaller than the "Start Stimulus" value of segment no. $n+1$).
- Overlapping segments are allowed. The limit check in the overlapping area is related to the tighter limit (the pass test involves a logical AND operation).
- Gaps between segments are allowed and equivalent to switching off an intermediate limit line segment.
- Limit lines can be partially or entirely outside the sweep range, however, the limits are only checked at the measurement points.

The following figure shows a limit line consisting of 3 upper and 2 lower limit line segments. To pass the limit check, the trace must be confined to the shaded area.

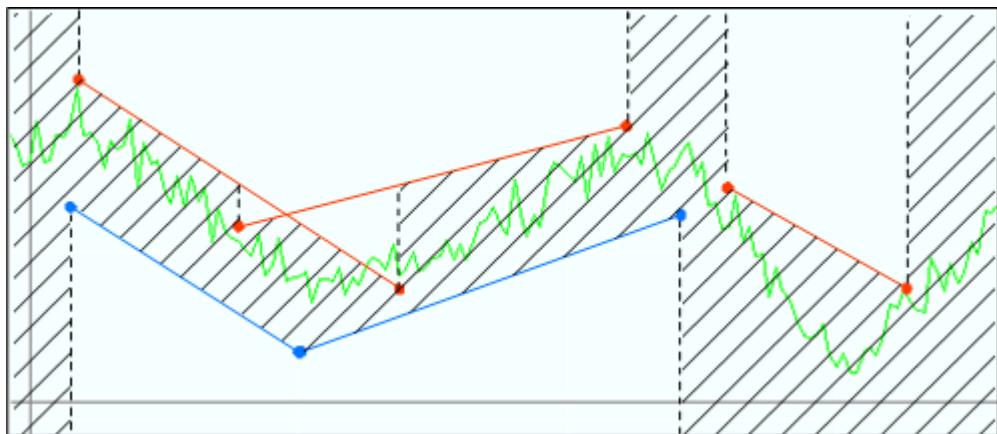

As a consequence of the limit line rules, a DUT always passes the limit check if no limit lines are defined.



Formula-defined limit lines

A limit line doesn't have to be straight. You can also use a custom formula to define it.

When the sweep axis is changed from linear frequency sweep to logarithmic sweeps, straight limit lines are transformed into exponential curves. The sweep points are redistributed along the x-axis, so the number of failed points can change.

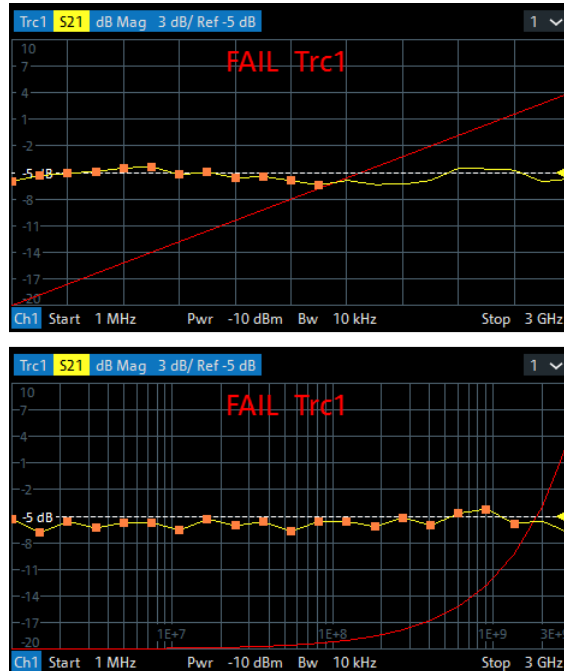

Logarithmic interpolation

The analyzer offers a logarithmic interpolation mode that allows you to carry over the limit line definition to logarithmic sweeps.

While "Show Limit Line" is active, the diagrams display all limit line segments.

Exception: In a segmented frequency sweep with point-based x-axis, gaps between the segments are minimized. To facilitate the interpretation, the R&S ZNL/ZNLE displays only the limit line segments which provide the limit check criterion (the "tighter" limit line at each point). In the example below, this rule results in a single, continuous lower limit line.



9.4.1.2 Rules for Ripple Test Definition

The analyzer places few restrictions on the definition of ripple limit ranges.

The following rules ensure a maximum of flexibility:

- Ranges do not have to be sorted in ascending or descending order (e.g. the "Start Stimulus" value of range no. n does not have to be smaller than the "Start Stimulus" value of range no. n+1).
- Overlapping ranges are allowed. The limit check in the overlapping area is related to the tighter limit (the pass test involves a logical AND operation).
- Gaps between ranges are allowed and equivalent to switching off an intermediate ripple limit range.
- Ripple limit ranges can be partially or entirely outside the sweep range, however, the limits are only checked at the measurement points.

The following figure shows a ripple limit test involving 3 active ranges.

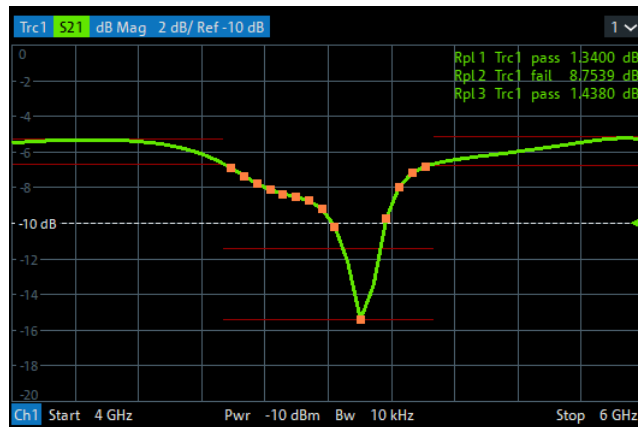

The limit line rules for logarithmic sweeps and segmented frequency sweeps with point-based x-axis also apply to ripple limit lines (see [Chapter 9.4.1.1, "Rules for Limit Line Definition"](#), on page 232).

9.4.1.3 Circle Limits

A circle limit is a special type of **upper** limit line which is defined by its center coordinate in the diagram and its radius. Depending on the diagram type, circle limit can serve different purposes:

- With a circle limit line centered on the origin of a polar diagram, you can check whether the magnitude of the measurement results exceeds a limit, defined by the radius of the limit line.

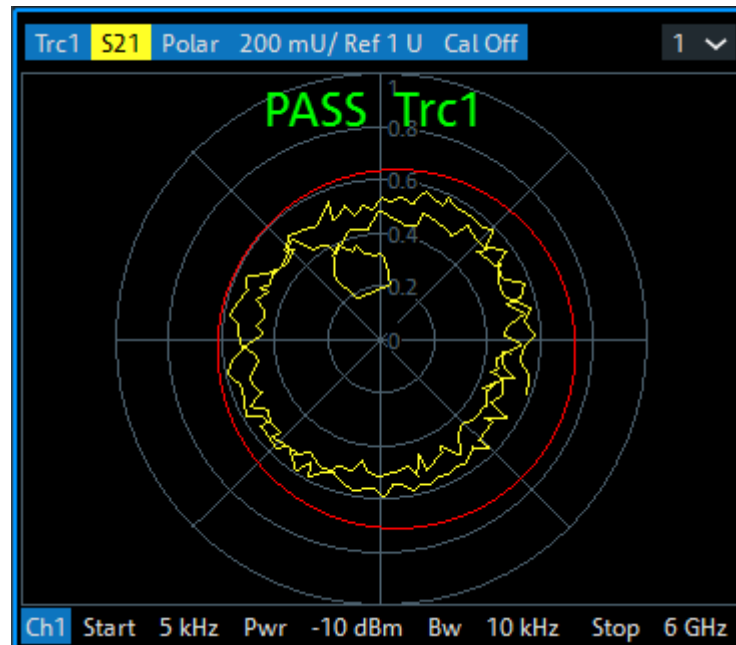

- With a circle limit line adjusted to the right border of a Smith diagram ($Z = \text{infinity}$), you can check whether the imaginary part of the impedance ($\text{Im}(Z)$, reactance) falls below a limit.

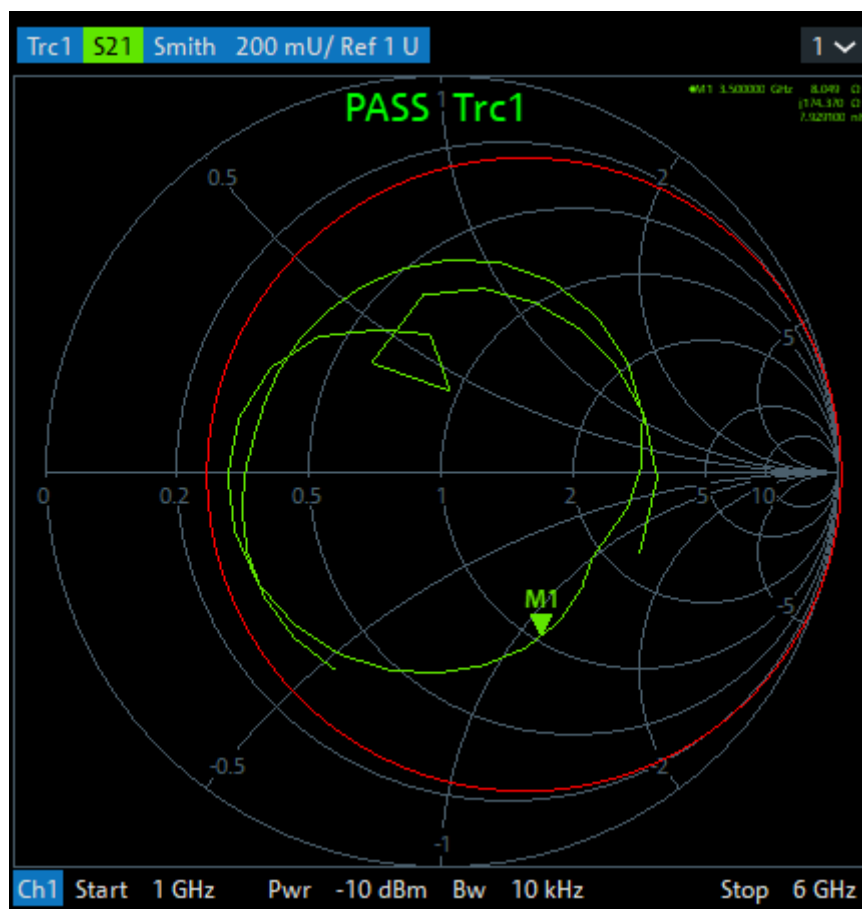

- With a circle limit line centered on the left border of an inverted Smith diagram ($Y = \infty$), you can check whether the imaginary part of the admittance ($\text{Im}(Y)$, susceptance) falls below a limit.

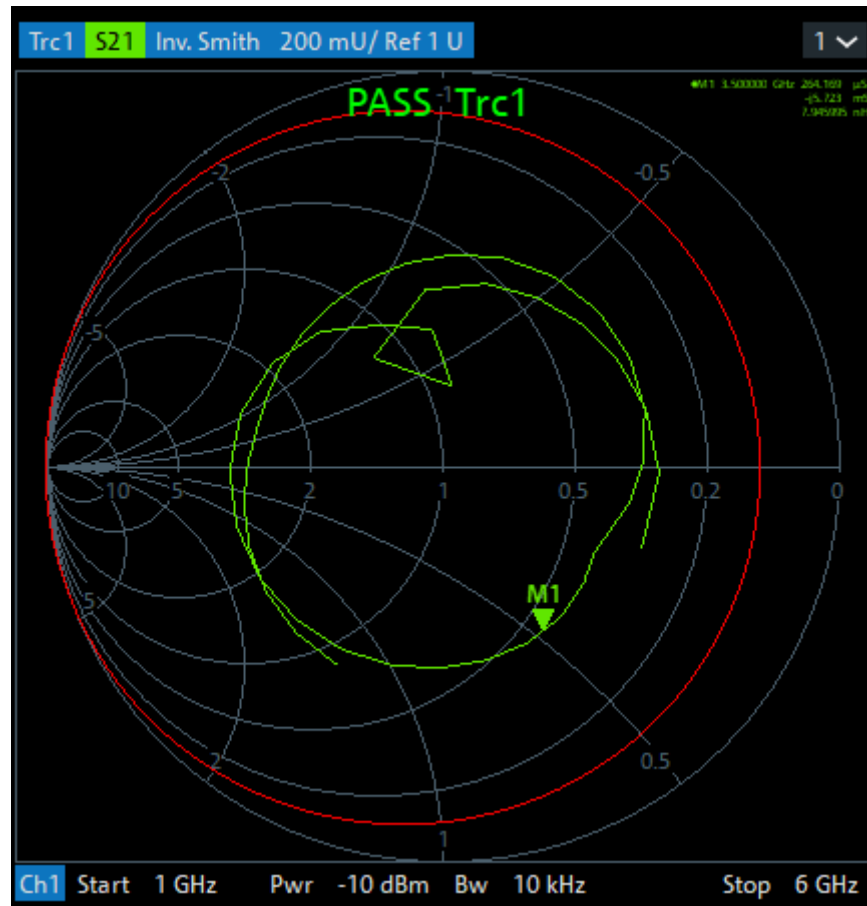

9.4.1.4 File Format for Limit Lines

The analyzer uses a simple ASCII format to export limit line data. By default, the limit line file has the extension *.limit and is stored in the directory shown in the "Save Limit Line" and "Recall Limit Line" dialogs. The file starts with a preamble containing the channel and trace name and the header of the segment list. The following lines contain the entries of all editable columns of the list.

Example of a limit line file

The limit line:

#	Type	Start Stimulus	Stop Stimulus	Start Response	Stop Response
1	Upper	9 kHz	8.5 GHz	0 dB	0 dB
2	Lower	9 kHz	6 GHz	-20 dB	-10 dB
3	Off	6 GHz	8.5 GHz	-10 dB	-10 dB

is described by the limit line file:

```
# Version 1.00
# Channel 1
# Trace 1
en:Type,Start Stimulus[MHz],Stop Stimulus[MHz],Start Response[dB],Stop Response[dB],
Upper,8.999999999999999E-003,8.500000000000000E+003,0.000000000000000E+000,0.000000000000000E+000,
Lower,8.999999999999999E-003,6.000000000000000E+003,-2.000000000000000E+001,-1.000000000000000E+001,
Off,6.000000000000000E+003,8.500000000000000E+003,-1.000000000000000E+001,-1.000000000000000E+001,
```



Compatibility with other instruments

The VNAs of the R&S ZNx and R&S ZVx families use the same file format. Limit line files can be interchanged without restriction.

9.4.1.5 File Format for Ripple Limits

The analyzer uses a simple ASCII format to export ripple limits. By default, the ripple limit file has the extension *.ripple and is stored in the directory shown in the "Save Ripple Limits" and "Recall Ripple Limits" dialogs. The file starts with a preamble containing the channel and trace name and the header of the range list. The following lines contain the entries of all editable columns of the list.

Example of a ripple limit file

The ripple limit list:

	Range On/Off	Start Stimulus	Stop Stimulus	Ripple Limit
1	<input checked="" type="checkbox"/>	3 GHz	5 GHz	12 dB
2	<input checked="" type="checkbox"/>	4.5 GHz	5.5 GHz	5 dB
3	<input type="checkbox"/>	5.5 GHz	6 GHz	4.3826 dB

is described by the ripple limit file:

```
# version 1.00
#
# Channel 1
# Trace 1
bo:Range on/off,start stimulus[MHZ],stop stimulus[MHZ],Ripple Limit[dB],
true,3.000000000000000E+003,5.000000000000000E+003,1.200000000000000E+001,
true,4.500000000000000E+003,5.500000000000000E+003,5.000000000000000E+000,
false,5.500000000000000E+003,6.000000000000000E+003,4.382581058243317E+000,
```



Compatibility with other instruments

The VNAs of the R&S ZNx and R&S ZVx families use the same file format. Ripple limit files can be interchanged without restriction.

9.4.2 Trace Files

The R&S ZNL/ZNLE can store one or several data or memory traces to a file or load a memory trace from a file.

Trace files are ASCII files with selectable file format. The analyzer provides several types of trace files:

- Touchstone (*.s<n>p) files
- ASCII (*.csv) files
- Matlab (*.dat) files are ASCII files which can be imported and processed in Matlab.

The trace file formats complement each other; see [Chapter 9.4.2.3, "Finding the Best File Format"](#), on page 246.



- When exporting traces to a file, it is recommended to set the analyzer to single sweep mode ([Sweep] > ""Sweep Control"" > "All Channels on Hold"). This mode ensures that a complete sweep is exported.
- The number of decimal places of stimulus and data values in export files is configurable.

9.4.2.1 Touchstone Files

The Touchstone file format is a standard for the transfer of frequency-dependent network data. Based on information from Agilent Corporation (the originator of Touchstone), formal specifications were produced by the EIA/IBIS Open Forum.

- [Touchstone File Format Specification Rev 1.1](#)
- [Touchstone File Format Specification Version 2.0](#)

The R&S ZNL/ZNLE supports Touchstone file versions 1.1 and 2.0.

By convention, Touchstone files use file extensions `.snp`, where `n` is the number of network ports. The following displays an `s1p` export file in "Version 1.1 (ZNx)" format:

```

1 # HZ S RI R 50.00
2 ! Rohde & Schwarz Vector Network Analyzer
3 ! Rohde-Schwarz,ZNL6-2Port,1323001206100005,1.37
4 ! Created: UTC 12/24/2020, 5:20:26 PM
5 ! My Comment
6 ! freq[Hz] re:S11 im:S11
5.000000000000000E3 -4.609351754188538E-1 4.146673157811165E-2
3.000497500000000E7 -4.751487076282501E-1 3.597813099622726E-2
6.000495000000000E7 -5.026257038116455E-1 4.391665756702423E-2
...

```

- 1 = option line
- 2 = VNA identification comment
- 3 = timestamp comment
- 4 = user-defined comment
- 5 = network data table header comment
- 6 = network data table

General Syntax Rules

Among others, the following general syntax rules apply:

- Touchstone files are ASCII files, 8-bit encoded using ISO/IEC 8859-1:1998. Only the graphical characters 0x20 to 0x7E, the tab character 0x09, and the three line termination sequences LF (0x0A), CR+LF (0x0D + 0x0A), and CR (0x0Dh) are allowed.
- Touchstone files are case-insensitive.
- Blank lines are permitted.

Option Line

Each Touchstone file must contain an option line with the following structure:

```
# <frequency unit> <parameter> <data format> R <reference
resistance>
```

- # indicates the beginning of the option line
- <frequency unit> can be either Hz, kHz, MHz or GHz. Default is GHz. The R&S ZNL/ZNLE always uses HZ for exported data.
- <parameter> specifies what kind of network parameter data is contained in the file. Default is S for S-parameters, which is the only parameter type the R&S ZNL/ZNLE supports.
- <data format> specifies how the complex network parameter data are formatted. Possible values are RI for "Real-Imag", MA for "Lin Mag-Phase", and DB for "dB Mag-Phase". Default is MA.
According to the Touchstone file standards, dB Mag = $20 \times \log_{10} \text{Mag}$, and the phase is always represented in degrees.
During data export, the analyzer allows you to select the suitable <data format>.
- <reference resistance> specifies the impedance system underlying the network data, given as a real, positive resistance. Its value is given in Ω (default 50). During export, if the impedances of all involved ports are identical, the analyzer sets the <reference resistance> to the real part of this impedance. Otherwise it sets it to 50.

With the exception of the opening # symbol and the value following R, option line parameters can appear in any order. If a parameter is missing, the default value is assumed.

Comments

Comments can be used for any kind of documentation purpose, e.g. to describe the network parameter data and how they were generated.

Syntactically, comments are preceded by an exclamation mark and terminated by a line termination sequence (see "[General Syntax Rules](#)" on page 239). They can appear anywhere in the file, either on a separate line, or after the parsed content of a line. Any number of comment lines can be inserted.

The content of the comments is not standardized in any way. The following sections describe the comments the R&S ZNL/ZNLE inserts into a Touchstone file during export.



During import, the R&S ZNL/ZNLE ignores all comments.

VNA identification

These comment lines identify the VNA that was used to generate the file.

```
! Rohde & Schwarz Vector Network Analyzer
! Rohde-Schwarz,ZNL6-2Port,1323001206100005,1.37
```

The first line is fixed, the second reflects the configurable identification string of the instrument.

Timestamp

The timestamp comment line reflects the time at which the Touchstone file was created. For "Version 1.1 (ZNx)" export format, it is represented as Coordinated Universal Time (UTC):

```
! Created: UTC 12/24/2020, 5:20:26 PM
```

The other export formats "Version 1.1" and "Version 2.0" use local time (Greenwich Mean Time + offset):

```
! Created: GMT+1 2020-12-24 18:20:26
```

Renormalization information

If, during export, the S-parameter data were renormalized with port-specific impedances, these impedances are written to the output file as a comment. In case the port-specific impedances are different, a note points out that the impedance system underlying the data is not interpreted correctly during import:

```
! The following Port Impedance Renormalization has been used when saving the data.
! PortZ Port1:100+j0 Port2:50+j0
!
! Note: The Port Impedances differ from the reference impedance of this file.
!       While reading the file the reference impedance value of the option line above
!       is always used.
```

For more information, see ["Renormalization of S-Parameters"](#) on page 245.



For the "Version 2.0" export format, the port impedances are currently not written to the renormalization information comment. Instead, the real parts of the port impedances appear as arguments of the `[Reference]` keyword.

Network data table header

These comment lines indicate the content of the [Network Parameter Data](#) table right below it.

As the first column of the data table is always designated to the frequency points, the first table header comment always starts with `! freq[Hz]`.

- **"Version 1.1 (ZNx)" export format**

For this format, the header explicitly specifies the exported parameters and their data format. The port numbers of single-ended S-parameters in the header are the "real" (physical) port numbers:

```
! freq[Hz] re:S22 im:S22 re:S12 im:S12 re:S21 im:S21 re:
S11 im:S11
```

Up to port reordering, which is possible via "snp free config" export and via logical port assignment, the order in which the parameter data occur is the one described in the Touchstone 1.1 standard. See ["Network Parameter Data"](#) on page 243.

If balanced parameters are exported, the assigned logical port number is used:

```
! freq[Hz] re:Sdd11 im:Sdd22 re:Scd22 im:Scd22 re:Sdc22 im:
Sdc22 re:Scd22 im:Scd22
```

- **"Version 1.1" and "Version 2.0" export formats**

These export formats always use single-ended identifiers S_{ij} and port numbers 1 to n in the table header.

```
! freq[Hz] S11[Re] S11[Im] ...
```

The mapping between nominal (single-ended) and actual – possibly balanced – ports is given in the [port assignments](#) comments.

Port assignments (Version 1.1 and Version 2.0)

For export format "Version 1.1 (ZNX)", the assignments are given in the [Network data table header](#) comment lines. For export formats "Version 1.1" and "Version 2.0", they are declared in a dedicated comments section:

```
! Port Assignments:
! Nominal Port -> Actual Test Port
! -----
!   1 -> 2
!   2 -> 1
```

For balanced ports, the port assignment looks like in the following example:

```
! Port Assignments:
! Nominal Port -> Actual Test Port
! -----
!   1 -> D1,2
!   2 -> C1,2
```

The "s1p Active Trace" export, which allows to dump an arbitrary S-parameter trace to an s1p file, explicitly mentions the exported parameter:

```
! Trace info:
! Nominal Param -> Actual Exported Buffer
! -----
! S11 -> S21
```

User comment

The analyzer's trace export function allows you to insert a custom comment line into the export file.

```
! My Comment
```

Keywords (Version 2.0 Only)

Keywords are enclosed in square brackets, “[” and “]”, and start at the beginning of a line. Arguments after keywords (if any) are separated from the closing bracket and from each other by at least one blank (or tab).

```
[Keyword] argument1 argument2 ...
```



Keywords are new in Touchstone standard version 2.0. They are not allowed in version 1.1 files.

The purpose of the keywords is to give more details about the file contents in a standardized way. During "Version 2.0" export, the R&S ZNL/ZNLE writes the following keywords to the generated Touchstone file:

Keyword	Example	Description
[Version]	[Version] 2.0	Specification version, typically the first line in the file Currently only 2.0 is allowed
[Number of Ports]	[Number of Ports] 2	The <i>n</i> in the generated <i>snp</i> file. Except for the "s1p Active Trace" export, <i>n</i> equals the number of physical ports involved in the export.
[Two-Port Data Order]	[Two-Port Data Order] 21_12	Specifies the data order in <i>s2p</i> files. <ul style="list-style-type: none"> • 21_12 indicates data order f N11 N21 N12 N22 • 12_21 indicates data order f N11 N12 N21 N22 (see "Data arrangement" on page 244) The R&S ZNL/ZNLE generates <i>s2p</i> files with fixed data order 21_12 (according to the TS1.1 standard).
[Number of Frequencies]	[Number of Frequencies] 201	Number of exported frequency sweep points; can also be derived from the Network Parameter Data block.
[Reference]	[Reference] 50 75	If the exported S-parameter data were renormalized with port-specific impedances, the real parts of these impedances are listed as arguments of the [Reference] keyword. Overrides the common reference impedance of the "Option Line" on page 239 Note: currently ignored during import
[Mixed-Mode Order]	[Mixed-Mode Order] D1,2 C1,2	Required if a balanced port is involved. In the example to the left, nominal port 1 is the differential mode and nominal port 2 is the common mode of balanced port (1,2). Conveys the same information as the Port assignments (Version 1.1 and Version 2.0) comment
[Network Data]	[Network Data] ! no args	Marks the begin of the Network Parameter Data block
[End]	[End] ! no args	Marks the end of the network parameter data section and is typically placed in the last line of the export file

For details and more keywords, see the Touchstone File Format Specification Version 2.0 (http://www.ibis.org/touchstone_ver2.0/touchstone_ver2_0.pdf).



During import, the R&S ZNL/ZNLE currently only considers the [Two-Port Data Order].

Network Parameter Data

The network parameter data section contains one block of network parameters per frequency point. Each block is preceded by a frequency value, i.e. the first entry in the

first (or only) data line of a data block is a frequency value. The complex network parameter data is formatted as pairs of values. The following general rules apply

- Individual entries in a network data line are separated by whitespace
- In version 1.1 files, no more than four parameters are allowed per network data line. No restriction exists on the number of data pairs on a line in version 2.0 files.
- The network data blocks are arranged in ascending order of frequency



For segmented sweeps, the R&S ZNL/ZNLE makes an exception to the strict "ascending order" principle. During export, the segments are always kept together, which can result in downward "frequency jumps" at segment borders.

Data arrangement

During export, for each block the R&S ZNL/ZNLE arranges the frequency value f and network parameter data $(N_{i,j})_{1 \leq i,j \leq n}$ as described in the Touchstone 1.1 standard.

- **n = 1**
f N11
- **n = 2**
f N11 N21 N12 N22

The data blocks are arranged in ascending order of frequency.

Data format

Frequencies are represented as single positive numbers, network parameter data as pairs of numbers. The <frequency unit> and <data format> are specified in the [Option Line](#). Numbers can be represented as decimal integers or floating point numbers, with "." used as decimal separator. Scientific notation is allowed (e.g., $1.2345e-12$). No minimum or maximum limits are placed on numerical precision.

For Touchstone export, the R&S ZNL/ZNLE uses the normalized scientific notation, with a significand (mantissa) of length 17 (+1 for the minus sign) and an exponent with maximum length 2 (+1 for the minus sign).

1.0000000000000000e+09	-2.375070438098596e-01	-4.533104459856211e-01
1.0100000000000000e+09	-3.132740349817996e-01	-5.874596585157938e-01
1.0200000000000000e+09	-3.062444919836442e-01	-4.587379501906624e-01

Conditions for Touchstone File Export

- One-port Touchstone files with data from a single trace
Typically, Touchstone files contain a complete set of S-parameter traces of an n-port network. The only exceptions are s_{1p} files created from arbitrary S-parameter traces using the "s1p Active Trace" export function in the [Trace Data Tab](#) or the remote command `MMEMoRY:STORe:TRACe`.
- Touchstone files containing S-matrices
 - For a one-port Touchstone file, the reflection coefficient for the specified port (S_{ii} for port i) must be measured. If a full one-port (Refl OSM) or a full n-port (TOSM, ...) calibration is available for the specified port, it is possible to export the data even when the trace is not displayed.

- For a multiport Touchstone file *.s<n>p, either a full multiport system error correction or a complete set of n^2 S-parameter traces must be available. If the port configuration contains balanced ports, the exported Touchstone file contains the converted single-ended S-parameters unless you enable "Balanced Params" during export.
- Export of balanced (symmetric) S-parameters must be enabled. If you want to export balanced S-parameters, make sure that all these parameters are measured, and that for each involved balanced port both physical ports are part of the export.

This type of export can be initiated from the GUI by using the "s<n>p Port ..." or "snp Free Config. ..." functions of the [Trace Data Tab](#) or by the remote command `MMEMory:STORe:TRACe:PORTs` on page 809.

Renormalization of S-Parameters

Renormalization means that the S-parameters at connector impedances are converted to S-parameters at certain target impedances.

During Touchstone export, the S-parameters can be renormalized in two ways:

- **Common target impedance**
The `<reference resistance>` of the [Option Line](#) is taken as common target impedance and the data is renormalized to the common target impedance, regardless of the reference impedances of the involved ports. If the impedances of all involved ports are identical, the analyzer sets the `<reference resistance>` in the [Option Line](#) to the real part of this impedance. Otherwise it sets it to 50 (Ω).
- **Port-specific Reference Impedances**
In this case, the reference impedances of the individual ports are used for the renormalization and these impedances are documented in the [Renormalization information](#) comment. If the port-specific reference impedances are different, an additional warning is added to this comment, indicating that the option line contains a non-matching reference resistance.
Note that when reimporting this type of file into standard applications (including the R&S ZNL/ZNLE itself), the `<reference resistance>` of the Touchstone option line is used and the impedance system underlying the data is not interpreted correctly.

9.4.2.2 ASCII (*.csv) Files

An ASCII file contains a header and the actual trace data:

```
freq;reTrc1_S21;imTrc1_S21;reMem2[Trc1]_S21;imMem2[Trc1]_S21;
300000.000000;0.000000;0.000000;0.000000;0.000000;
40499497.487437;0.000000;0.000000;0.000000;0.000000;
80698994.974874;0.494927;-0.065174;0.500833;-0.074866;
120898492.462312;0.497959;-0.111724;0.488029;-0.107375;
...
```

The header consists of the following data elements:

- <Stimulus> stimulus variable: freq for Frequency sweep, time for Time sweep, trigger for CW Mode sweep.
- <reTrace1> first response value of first trace: re<Trace_Name>, mag<Trace_Name> or db<Trace_Name> for output format Re/Im, lin. Mag-Phase or dB Mag-Phase, respectively. The data format for export files can be selected in the Export Data dialog.
- <imTrace1> second response value of first trace: im<Trace_Name> for output format Re/Im, ang<Trace_Name> for output formats lin. Mag-Phase or dB Mag-Phase. The data format for export files can be selected in the Export Data dialog.
- <reTrace2> first response value of second trace: re<Trace_Name>, mag<Trace_Name> or db<Trace_Name> for output format Re/Im, lin. Mag-Phase or dB Mag-Phase, respectively. The data format for export files can be selected in the Export Data dialog.
- <imTrace2>... second response value of second trace: im<Trace_Name> for output format Re/Im, ang<Trace_Name> for output formats lin. Mag-Phase or dB Mag-Phase. The data format for export files can be selected in the Export Data dialog. first response value of second trace. HZ / KHZ / MHZ / GHZ allowed for imported files. The analyzer always uses HZ for exported data. second response value of first trace: im<Trace_Name> for output format Re/Im, ang<Trace_Name> for output formats lin. Mag-Phase or dB Mag-Phase. The data format for export files can be selected in the Export Data dialog.

The trace data is arranged as described in the header. Different values are separated by semicolons, commas or other characters, depending on the selected "Decimal Separator" in the "Export ... Data" dialogs. A semicolon is inserted before the end of each line.

The stimulus values are arranged in ascending order.

9.4.2.3 Finding the Best File Format

The file format depends on how you want to use the exported data.

Use a **Touchstone** file format to export S-parameter data traces to a file that can be evaluated with applications such as Keysight's Advanced Design System (the former Microwave Design System), and to convert mixed mode parameters back to single-ended parameters. The data must be acquired in a frequency sweep. Note the "[Conditions for Touchstone File Export](#)" on page 244.



Touchstone files cannot be used to export mathematical traces.

Use the **ASCII (*.csv)** format if you want to do one of the following:

- Import the created file into a spreadsheet application such as Microsoft Excel.
- Export an arbitrary number of traces, multiple traces with the same parameter or memory traces.
- Export traces acquired in a CW sweep.

- Use export options.

Use the **Matlab (*.dat)** format if you want to import and process the trace data in Matlab.

9.4.3 Memory-Mapped Trace Data Transfer

The VNA firmware uses the *Named Shared Memory Windows* feature to share trace data with other processes running on the instrument. Such processes or applications can read trace data directly from the shared memory, which is much faster than using SCPI commands.

Multiple traces can be written to the same shared memory buffer. For each of these traces, the firmware stores a configurable number of formatted or unformatted trace values to a contiguous part of the shared memory.

- A formatted (real) trace value takes up 8 bytes of memory.
- An unformatted (complex) trace value takes up 16 bytes: 8 bytes for the real part, 8 bytes for the imaginary part.

Memory-mapped trace data transfer is a pure remote control feature. Once set up, the VNA firmware refreshes the shared memory trace data with every sweep. Other processes can read these data via standard APIs for Windows *Named Shared Memory* that are available for various programming languages.



You can create multiple shared memory buffers, e.g. with different intended life span.

Set up a shared memory buffer

The setup of a shared memory buffer and the allocation of trace data is performed by a sequence of `SYSTEM:DATA:MEMory...` commands, starting with an `INITialize` and finished by a `COMMit`.

1. Initialize the shared memory buffer:
`SYSTEM:DATA:MEMory:INITialize`

2. Add traces:

- a) `SYSTEM:DATA:MEMory:ADD '<TrName1>', FDATA|SDATa, #Values1`
Select an existing trace name, choose whether to use formatted trace data (FDATa) or unformatted trace data (SDATa), and define how many trace values the firmware writes to the buffer per sweep.
The data block of the first trace has an offset of 0 bytes relative to the start of the shared memory buffer.
- b) `SYSTEM:DATA:MEMory:ADD '<TrName2>', FDATA|SDATa, #Values2`
Use `SYSTEM:DATA:MEMory:OFFSet?` to query the offset in bytes of the second trace data block. Processes that want to read the trace data from the buffer need to know this offset. Its size depends on whether the first trace data block contains formatted (real) or unformatted (complex) values.

c) ...

Use `SYSTem:DATA:MEMory:OFFSet?` to query the offset of the last added trace.

3. Create the named shared memory buffer:

```
SYSTem:DATA:MEMory:COMMit '<ShMemName>'
```

The name must be unique. Before the `COMMit` you can use `SYSTem:DATA:MEMory:CATalog?` to query the names of existing shared memory buffers.

The size of the last created shared memory buffer can be queried using `SYSTem:DATA:MEMory:SIZE?`.

Use a shared memory buffer

After you have created a named shared memory buffer, you can access it – from the instrument – using your favorite programming language and API. With Python, for instance, you can use the `mmap` module for this purpose.

Delete a shared memory buffer

To delete a shared memory buffer and free the occupied memory, you can use one of the following commands.

1. `SYSTem:DATA:MEMory:DELeTe '<ShMemName>'`
deletes a single shared memory buffer by name.
2. `SYSTem:DATA:MEMory:RESet`
deletes all shared memory buffers created using `SYSTem:DATA:MEMory:COMMit`.

9.5 Calibration

Calibration or system error correction is the process of eliminating systematic, reproducible errors from the measurement results (S-parameters and derived quantities). The process involves the following stages:

1. A set of calibration standards is selected and measured over the required sweep range.
For many calibration types, the magnitude and phase response of each calibration standard (i.e. its S-parameters if no system errors occur) must be known within the entire sweep range.
2. The analyzer compares the measurement data of the standards with their known, ideal response. The difference is used to calculate the system errors using a particular error model (calibration type) and derive a set of system error correction data.
3. The system error correction data is used to correct the measurement results of a DUT that is measured instead of the standards.

Calibration is always channel-specific because it depends on the hardware settings, in particular on the sweep range. This means that a system error correction data set is stored with the calibrated channel.

The analyzer provides a wide range of sophisticated calibration methods for all types of measurements. Which calibration method is selected depends on the expected system errors, the accuracy requirements of the measurement, on the test setup and on the types of calibration standards available.

Due to the analyzer's calibration wizard, calibration is a straightforward, menu-guided process. Moreover, it is possible to perform the entire calibration process automatically using a Calibration Unit (e.g. R&S ZN-Z5x or R&S ZN-Z15x).



The system error correction data determined in a calibration procedure are stored on the analyzer. You can read these correction data using the remote control command `[SENSe<Ch>:]CORRection:CDATa`. You can also replace the correction data of the analyzer by your own correction data sets.



Cal Off label

A label "Cal Off" appears in the trace line if the system error correction no longer applies to the trace:

Trc1 S21 dB Mag 10 dB/ Ref 0 dB Cal Off

This can happen for one of the following reasons:

- The sweep range is outside the calibrated frequency range.
- The channel calibration is not sufficient for the measured quantity (e.g. a one-port calibration has been performed, but the measured quantity is a transmission parameter).
- The system error correction has been switched off deliberately ("User Cal Active" is disabled).

The analyzer provides other labels to indicate the status of the current calibration; see [Chapter 9.5.4, "Calibration Labels"](#), on page 260.



Calibration and port de-/activation

The analyzer firmware automatically activates/deactivates ports during/after a (successful) calibration:

- Calibrated ports that were previously disabled, are automatically enabled as single-ended logical ports.
- An uncalibrated port that is not used by a measurement (i.e. the port is not required by any trace of the related channel) is disabled.

9.5.1 Calibration Types

The analyzer provides a wide range of calibration types for one, two or more ports. The calibration types differ in the number and types of standards used, the error terms, i.e.

the type of systematic errors corrected and the general accuracy. The following table gives an overview.

Table 9-7: Overview of calibration types

Calibration Type	Standards	Parameters	Error Terms	General Accuracy	Application
Reflection Normalization	Open or Short	S_{ii} for Port i	Reflection tracking	Low to medium	Reflection measurements on any port.
Transmission Normalization	Through	S_{ij} for port pair (i,j) , $i \neq j$	Transmission tracking	Medium	Transmission measurements in any direction and between any combination of ports.
Reflection OSM	Open, Short, Match ¹⁾	S_{ii} for Port i	Reflection tracking, Source match, Directivity,	High	Reflection measurements on any port.
One Path Two Ports	Open, Short, Match ¹⁾ (at source port), Through ²⁾ between the source port and all target ports	S_{tj} for fixed source port j and target ports t	Reflection tracking, Source match, Directivity, Transmission tracking	Medium to high	Unidirectional transmission measurements in any direction and between any combination of ports.
TOSM or UOSM (2-port)	Open, Short, Match ¹⁾ (at each port), Through ²⁾ (between all port pairs)	All	Reflection tracking, Source match, Directivity, Load match, Transmission tracking,	High	Reflection and transmission measurements; classical 12-term error correction model.

¹⁾ Or any other 3 known one-port standards. To be used in a guided calibration, the known standards must be declared to be Open, Short, and Match irrespective of their properties.

²⁾ Or any other known two-port standard. To be used in a guided calibration, the known standard must be declared to be Through, irrespective of its properties.



The calibration type must be selected in accordance with the test setup. Select the calibration type for which you can obtain or design the most accurate standards and for which you can measure the required parameters with best accuracy.

- [Normalization \(Refl Norm..., Trans Norm...\)](#).....251
- [Reflection OSM Calibration](#).....251
- [One Path Two Ports Calibration](#).....251
- [TOSM and UOSM Calibration](#).....252
- [Complementary Isolation Measurement](#).....253

9.5.1.1 Normalization (Refl Norm..., Trans Norm...)

A normalization is the simplest calibration type since it requires the measurement of only one standard for each calibrated S-parameter:

- One-port (reflection) S-parameters (S_{11} , S_{22} , ...) are calibrated with an Open or a Short standard providing the reflection tracking error term.
- Two-port (transmission) S-parameters (S_{12} , S_{21} , ...) are calibrated with a Through standard providing the transmission tracking error term.

Normalization means that the measured S-parameter at each sweep point is divided by the corresponding S-parameter of the standard. A normalization eliminates the frequency-dependent attenuation and phase shift in the measurement path (reflection or transmission tracking error). It does not compensate for directivity or mismatch errors. This limits the accuracy of a normalization.



- Manual reflection normalizations offer [Complementary Match Standard Measurements](#)
- Manual transmission normalizations support [Complementary Isolation Measurement](#) (optional).

Complementary Match Standard Measurements

For reflection normalizations, the mandatory Open or Short measurements can be complemented by optional Match measurements. Additionally, measuring a Match standard allows you to eliminate errors due to the directivity of the internal couplers, which improves the accuracy of reflection measurements on well-matched DUTs (high return loss).



For reflection measurements on DUTs with low return loss, accuracy may be degraded compared to a simple reflection normalization.

9.5.1.2 Reflection OSM Calibration

A reflection OSM (full one-port) calibration requires a Short, an Open and a Match standard to be connected to a single test port. The three standard measurements are used to derive all three reflection error terms:

- The Short and Open standards are used to derive the source match and the reflection tracking error terms.
- The Match standard is used to derive the directivity error.

A reflection OSM calibration is more accurate than a normalization but is only applicable for reflection measurements.

9.5.1.3 One Path Two Ports Calibration

A one path two ports calibration combines a reflection OSM (full one-port) calibration with a transmission normalization. The fully calibrated port is termed the node port.

This calibration type requires a Short, an Open and a Match standard to be connected to a single test port plus a Through standard between this calibrated source port and the other load ports. The four standard measurements are used to derive the following error terms:

- The Short and Open standards are used to derive the source match and the reflection tracking error terms at the source port.
- The Match standard is used to derive the directivity error at the source port.
- The Through standard provides the transmission tracking error terms.

For calibration of two ports, a one-path two-port calibration requires only four standards to be connected (instead of 7 for a full two-port TOSM calibration). It is suitable when only the forward (e.g. S_{11} and S_{21}) or reverse S-parameters (e.g. S_{22} and S_{12}) are needed, and if the DUT is well matched, especially at the load port.

A one-path two-port calibration is also the best calibration method for test setups with unidirectional signal flow.

9.5.1.4 TOSM and UOSM Calibration

TOSM

A TOSM (Through – Open – Short – Match) calibration requires the same standards as the one path two ports calibration, however, all measurements are performed in the forward and reverse direction. TOSM is also referred to as SOLT (Short – Open – Load = Match – Through) calibration. The four standards are used to derive 6 error terms for each signal direction:

- In addition to the source match and reflection tracking error terms provided by the one-path two-port calibration, TOSM also provides the load match.
- The directivity error is determined at all source ports.
- The transmission tracking is determined for each direction.

TOSM calibration is provided for 2-port measurements. A 2-port TOSM calibration requires 7 standard measurements (3 one-port standards at each port and a Through between the two ports). The Through must be measured in both directions, so the number of standard measurements (calibration sweeps) is 8. The calibration provides 10 error terms (no isolation terms are available).



Manual TOSM calibration supports [Complementary Isolation Measurement](#) (optional).

UOSM: TOSM with unknown Through

The analyzer can perform a TOSM calibration with any 2-port network serving as through connection, as long as it fulfills the reciprocity condition $S_{21} = S_{12}$. The modified TOSM calibration is referred to as UOSM (Unknown through – Open – Short – Match) calibration. It can be selected as follows:

- If different connector types are assigned to the test ports, the analyzer automatically replaces TOSM by UOSM.

[The network analyzer supports different connector types at its test ports to measure DUTs with different port connectors.]

- If the same connector types are used but an appropriate Through standard is not defined, the analyzer also replaces TOSM by UOSM.

After acquiring the calibration sweep data for the unknown through, the analyzer automatically determines its delay time/transmission phase.



A R&S ZNL with VNA board 1323.2967 and firmware version 1.35 or higher supports manual and **automatic** UOSM calibration.

For all other R&S ZNL and all R&S ZNLE only automatic UOSM calibration is supported.

9.5.1.5 Complementary Isolation Measurement

For each port pair in a manual transmission normalization or TOSM calibration, the Through measurement can be complemented by an isolation measurement. This measurement accounts for possible crosstalk between the related test ports (e.g. on a test fixture).

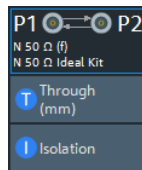

If isolation is measured, the corrected transmission coefficient of the DUT is calculated as:

$$\frac{(Transmission\ coefficient\ DUT - Isolation)}{(Transmission\ coefficient\ Through - Isolation)}$$

There is no dedicated physical standard for isolation measurement; it is recommended to terminate the test ports suitably (e.g. with 50 Ω loads).

9.5.2 Calibration Standards and Calibration Kits

A calibration kit is a set of physical calibration standards for a particular connector type. The magnitude and phase response of the calibration standards (i.e. their S-parameters) must be known or predictable within a given frequency range.

The standards are grouped into several types (Open, Through, Match,...) corresponding to the different input quantities for the analyzer's error models. The standard type also determines the equivalent circuit model used to describe its properties. The circuit model depends on several parameters that are stored in the cal kit file associated with the calibration kit.

As an alternative to using circuit models, it is possible to describe the standards with S-parameter tables stored in a file.

The analyzer provides many predefined cal kits but can also import cal kit files and create kits:

- A selection of predefined kits is available for all connector types. The parameters of these kits are displayed in the "View / Modify Cal Kit Standards" dialog, however, it is not possible to change or delete the kits.
- Imported and user-defined kits can be changed in the "Calibration Kits" dialog and its various subdialogs.

Calibration kits and connector types are global resources; the parameters are stored independently and are available irrespective of the current channel setup.

9.5.2.1 Calibration Standard Types

The following table gives an overview of the different standards and their circuit models (offset and load models).

Table 9-8: Calibration standard types

Standard Type	Characteristics	Ideal Standard	Offset Model	Load Model
Open	Open circuit (one-port)	$\infty \Omega$	<input checked="" type="checkbox"/>	<input checked="" type="checkbox"/>
Short	Short circuit (one-port)	0Ω	<input checked="" type="checkbox"/>	<input checked="" type="checkbox"/>
Offset short	Short circuit with added electrical length offset, for waveguide calibration (one-port)	0Ω	<input checked="" type="checkbox"/>	<input checked="" type="checkbox"/>
Match	Matched broadband termination (one-port)	Z_0 (characteristic impedance of the connector type)	<input checked="" type="checkbox"/>	<input checked="" type="checkbox"/>
Sliding match	One-port standard consisting of an air line with a movable, low-reflection load element (sliding load)	–	–	–
Reflect	Unknown mismatched standard (one-port)	$\infty \Omega$	<input checked="" type="checkbox"/>	<input checked="" type="checkbox"/>
Through	Through-connection with minimum loss (two-port)	–	<input checked="" type="checkbox"/>	–
Line1, Line 2	Line(s) for TRL calibration with minimum loss (two-port)	–	<input checked="" type="checkbox"/>	–
Attenuation	Fully matched standard in both directions (two-port; the reflection factor at both ports is zero)	–	–	–
Symm. network	Unknown mismatched reflection-symmetric standard (two-port)	–	<input checked="" type="checkbox"/>	<input checked="" type="checkbox"/>

Offset parameters

The offset parameters have the following physical meaning:

- The *delay* is the propagation time of a wave traveling through the standard. The *electrical length* is equal to the delay times the speed of light in the vacuum. It is a measure for the length of transmission line between the standard and the actual calibration plane. For a waveguide with permittivity ϵ_r and mechanical length L_{mech} , the following relations hold:

$$\text{Delay} = \frac{L_{mech} \cdot \sqrt{\epsilon_r}}{c}; \quad \text{Electrical Length} = L_{mech} \cdot \sqrt{\epsilon_r}$$

The default delay is 0 s, the default step width is 1 ns, corresponding to a step width of 299.792 mm for the electrical length. The relations hold for one-port and 2-port standards.

- Z_0 is the characteristic impedance of the standard. If the standard is terminated with Z_0 , then its input impedance is also equal to Z_0 . Z_0 is not necessarily equal to the reference impedance of the system (depending on the connector type) or the terminal impedance of the standard. The characteristic impedance of the standard is only used in the context of calibration.

The default characteristic impedance is equal to the reference impedance of the system.

- The *loss* is the energy loss along the transmission line due to the skin effect. For resistive lines and at RF frequencies, the loss is approximately proportional to the square root of the frequency.

In Keysight mode, the *offset loss* is expressed in units of Ω/s at a frequency of 1 GHz. The following formula holds for two-port standards:

$$\text{Offset Loss} / [\Omega / s] = \frac{\text{Loss} / [dB] \cdot Z_0 / [\Omega]}{4.3429 / [dB] \cdot \text{delay} / [s]}$$

The conversion formula for one-port standards has an additional factor $\frac{1}{2}$ on the right-hand side. The reason for this factor is that the Loss in dB accounts for the attenuation along the forward **and** the reverse path. It does not depend on how often the wave actually propagates through the line, whereas the offset loss is proportional to the attenuation of the line.

To determine an offset loss value experimentally, measure the delay in seconds and the loss in dB at 1 GHz and use the formula above.

The default loss or offset loss is zero.



The impedance for waveguides is frequency-dependent. If a waveguide line type is selected in the "Cal Connector Types" dialog, the "Char. Imp." field is disabled and indicates "varies" instead of a definite impedance value. Moreover no loss or offset loss can be set.

Offset parameters and standard types

Offset parameters are used to describe all types of standards except the Sliding Match and the Attenuation.

- The Sliding Match is a one-port standard with variable load parameters (sliding load) and unspecified length. The reference impedance is fixed and equal to the characteristic impedance of the connector type. No load and offset parameters need to be set.
- The Attenuation is a two-port standard which is fully matched in both directions (the reflection factor at both ports is zero). No load and offset parameters need to be set.

Load parameters and standard types

Load parameters are used to describe all types of standards except a Through, a Sliding Match, a Line, and an Attenuation.

- The Through standard is a through-connection between two ports with minimum loss which is taken into account by the offset parameters.
- The Sliding Match is a one-port standard with variable load parameters (sliding load), so there is no fixed load model.
- The Line standard is a line of variable length with minimum loss which is taken into account by the offset parameters.
- The Attenuation is a two-port standard which is fully matched in both directions (the reflection factor at both ports is zero). No load and offset parameters need to be set.

9.5.2.2 Cal Kit Parameter Types

Available Cal Kits	
	Kit Name
1	N 50 Ω Ideal Kit
2	3653
3	85054D
4	ZV-Z121
5	ZV-Z170
6	ZCAN 50 Ω
7	ZV-Z21 typical
8	85032R/F

The analyzer uses three types of parameters to describe the calibration standards. The parameter type is the same for all standards in a kit and therefore appended to the kit name:

- **Universal** parameters (no suffix) describe calibration kit models with highly standardized components so that the parameters are valid for all calibration kits of the model.
- **Typical** parameters (suffix "typical") approximately describe a calibration kit model. To correct for deviations between the standards, each kit of the model is individually measured and delivered with an additional, kit-specific parameter set. Therefore each typical parameter set "<kit_name> typical" is complemented by an additional parameter set "<kit_name>" containing optimized parameters for an individual kit.
- **Ideal** parameters (suffix "Ideal Kit") describe an idealized calibration kit for each connector type; see below.



Make sure to use universal or individual parameter sets if you need to obtain high-precision results. The precision of the calibration kit parameters determines the accuracy of the system error correction and of the measurements. The R&S ZNL/ZNLE displays a warning if you use a typical or ideal parameter set to calibrate a channel.

Calibration kits can be obtained as network analyzer accessories; refer to the data sheet for the relevant ordering information. The name of all parameter sets is equal to the name of the corresponding calibration kit model.

Ideal parameters

All ideal kits contain the standards listed below.

Table 9-9: Ideal standard parameters

Standard (Gender)	R (Load)	Electrical Length (Offset)
Open (f, m)	$\infty \Omega$	0 mm (Delay: 0 s)
Short (f, m)	0 Ω	0 mm
Offset Short (f, m)	0 Ω	10 mm

Standard (Gender)	R (Load)	Electrical Length (Offset)
Match (f, m)	Z_0 (characteristic impedance of the connector type)	0 mm
Sliding Match (f, m)	–	0 mm
Reflect (f, m)	$\infty \Omega$	0 mm
Through (ff, mm, mf)	–	0 mm
Line (ff, mm, mf)	–	10 mm
Attenuation (ff, mm, mf)	–	0 mm
Symm. Network (ff, mm, mf)	–	0 mm

The following additional parameters are used:

- Characteristic impedance: Z_0 (characteristic impedance of the connector type)
- Loss: 0 dB / sqrt(GHz) or (0 G Ω / s) in Keysight mode
- All inductance and capacitance parameters are set to zero.

9.5.2.3 Sliding Match Standards

The Sliding Match is a one-port standard consisting of an air line with a movable, low-reflection load element (sliding load). This standard is used because a no perfect Match is available over a wide frequency range. However, a series of measurements at a given frequency with equal mismatch and varying phase yields reflection factors that are located on a circle in the Smith chart. The center of this circle corresponds to perfect match. The network analyzer determines and further corrects this match point following I. Kása's circle-fitting algorithm.

To obtain the reflection coefficient for a perfectly matched calibration standard, the Sliding Match must be measured at least at 3 positions which should be unequally spaced to avoid overlapping data points. Increasing the number of positions to 4 to 6 can improve the accuracy. Moreover, using the predefined load positions of the standard is recommended.

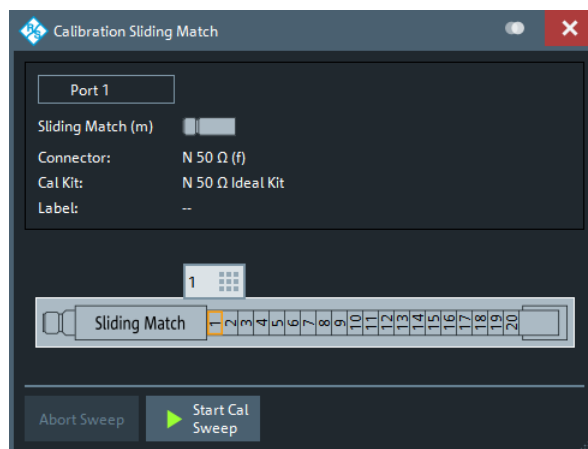

Figure 9-3: Sliding Match: GUI representation

A calibration is valid (and can be applied to the calibrated channel) if either the Match or three positions of the Sliding Match have been measured. However, it is often desirable to acquire calibration data from both standards.



The R&S ZNL/ZNLE can acquire correction data for up to 20 positions.

The analyzer combines the data in an appropriate manner:

- The Match results are used up to the lower edge of the specified frequency range of the Sliding Match (Min Freq).
- The Sliding Match results are used for frequencies above the Min Freq. In general, the Sliding Match provides better results than the Match within its specified frequency range.

9.5.2.4 Cal Kit Files

Calibration kit files can be used to store the parameters of a particular calibration kit, to reload the data and to exchange calibration kits from one network analyzer to another.

Cal kit file contents

Cal kit files are independent of the current channel setup and contain the following information:

- Name and label of the calibration kit
- Connector type including all connector type parameters (name, polarity, offset model, reference impedance)
- Type, gender and label of all standards in the kit together with the circuit model parameters (offsets, load) or S-parameter tables (.s<n>p file) that are necessary to determine its magnitude and phase response.

By default cal kit files are stored in the

C:\Users\Public\Documents\Rohde-Schwarz\ZNL\Calibration directory.

- To **export** cal kit data, the analyzer uses a specific binary file format *.calkit.
- Three different **import** file formats are supported: R&S ZVA-specific binary cal kit files (*.calkit), R&S ZVR-specific binary cal kit files (*.ck), cal kit files in Keysight-specific ASCII formats (*.csv, *.prn).



Importing older R&S ZVR cal kit files

On loading some older R&S ZVR-specific *.ck files, e.g. the R&S ZV-Z23 cal kit file, the R&S ZNL/ZNLE generates the message "File does not comply with instrument calibration kit file format". The files must be converted using an R&S ZVR network analyzer equipped with a firmware version V3.52 or later.

Proceed as follows:

- On the R&S ZVR, press "CAL > CAL KITS > MODIFY KITS > INSTALL NEW KIT" to import the *.ck file.
- Press "CREATE INST FILE" in the same submenu to export the *.ck file in a R&S ZNL/ZNLE-compatible format.
- Import the converted file into the R&S ZNL/ZNLE.

*.csv cal kit files: VNA Cal Kit Manager V2.1

The VNA Cal Kit Manager is a free, Windows®-based software tool intended to import, edit, and export *.csv cal kit files. The software is available for download at <http://na.support.keysight.com/vnahelp/products.html>. The decimal separator used by the VNA Cal Kit Manager V2.1 depends on the language version of the Windows® operating system: Cal kit files generated on an English operating system contain dots, the ones generated on a German system contain commas.

The network analyzer expects the dot as a separator and displays an error message when a *.csv file with commas is loaded. Please install the VNA Cal Kit Manager V2.1 on an appropriate (e.g. English) Windows® version to avoid trouble.

*.prn cal kit files: PNA Cal Kit Editor

The network analyzer can import and process cal kit files created with the PNA Cal Kit Editor. The files use the extension *.prn; the data format is identical to the *.csv format. The software is available for download at <http://na.support.keysight.com/pna/apps/#calkiteditor>.

The decimal separator used by the PNA Cal Kit Editor depends on the language version of the Windows® operating system: Cal kit files generated on an English operating system contain dots, the ones generated on a German system contain commas.

The network analyzer expects the dot as a separator and displays an error message when a *.prn file with commas is loaded. Please install the PNA Cal Kit Editor on an appropriate (e.g. English) Windows® version to avoid trouble.

9.5.3 Calibration Pool

The calibration "Pool" is a collection of correction data sets (cal groups) that the analyzer stores in a common directory

C:\Users\Public\Documents\Rohde-Schwarz\ZNL\Calibration\Data. Cal groups in the pool can be applied to different channels and channel setups. Each cal group is stored in a separate file named <CalGroup_name>.cal. The cal group name can be changed in the "Calibration Manager" dialog.

One of the available cal groups can be set as "Preset User Cal", i.e. the user correction data that should be restored after a user-defined preset.

If a new channel is created, the channel calibration of the active channel is also applied to the new channel. See also [Calibration Labels](#).

9.5.4 Calibration Labels

The following labels in the trace list inform you about the status or type of the current system error correction.

Table 9-10: Calibration labels (system error correction)

Label	Meaning
Cal	The system error correction is applied without interpolation. This means that a set of measured correction data is available at each sweep point.
Cal int	The system error correction is applied, however, the correction data for at least one sweep point is interpolated from the measured values. This means that the channel settings have been changed so that a current sweep point is different from the calibrated sweep points. It is not possible to disable interpolation.
Cal Off	The system error correction is no longer applied (e.g. "User Cal Active" is disabled). See also " Cal Off label " on page 249.

9.5.5 Automatic Calibration

A calibration unit is an integrated solution for automatic system error correction of vector network analyzers. Rohde & Schwarz offers a wide range of calibration units for different frequency ranges and connector types. The connector types of the calibration unit should be selected according to the connector types of the DUT.

The calibration units contain calibration standards that are electronically switched when a calibration is performed. The calibration kit data for the internal standards is also stored in the calibration unit, so that the analyzer can calculate the error terms and apply the calibration without any further input.



Advantages of automatic calibration

Automatic calibration is faster and more secure than manual calibration, because:

- There is no need to connect several standards manually. The number of connections to be performed quickly increases with the number of ports.
- Invalid calibrations due to operator errors (e.g. wrong standards or improper connections) are almost excluded.
- No need to handle calibration kit data.
- The internal standards do not wear out because they are switched electronically.

Limitations of automatic calibration

Calibration units do not contain characterized Through standards, so calibration types TOM, TSM, TRM, TRL, TNA are not available.

NOTICE

Safety instructions

Please observe the safety instructions provided with the calibration unit to avoid any damage to the unit and the network analyzer. Safety-related aspects of the connection and operation of the units are also reported in the following sections.

9.5.5.1 Connecting the Calibration Unit

The calibration units provide the following connectors:

- USB type B connector at the rear, which is used to power-supply and control the unit. A USB cable for connection to the network analyzer is provided with the calibration unit.
- RF connectors, which are connected to the test ports. For all Rohde & Schwarz calibration units except a customized R&S ZN-Z51, the connector types are equal for all ports.

To connect the unit,

1. Switch on and power up your network analyzer.
2. To protect your equipment against ESD damage, use the wrist strap and grounding cord supplied with the instrument and connect yourself to the GND connector at the front panel.
3. Connect the USB type A connector of the USB cable to any of the USB type A connectors of the analyzer. Connect the USB type B connector of the USB cable to the USB type B connector of the calibration unit.
4. Wait until the operating system has recognized and initialized the new hardware. When the unit is connected for the first time, this may take longer than in normal use.

The unit is ready to be used, see [Chapter 9.5.5.2, "Performing an Automatic Calibration"](#), on page 263.



Safety aspects

- The calibration unit is intended for direct connection to R&S ZNL/ZNLE network analyzers following the procedure described above. You can also connect the unit before switching on the analyzer. Do not connect the unit to other USB hosts, e.g. a PC, or insert any USB hubs between the analyzer and the unit, as this may damage the unit or the host.
- You can connect several calibration units to the different USB ports of the analyzer. You can also connect cal units and other devices (mouse, USB memory stick etc.) simultaneously.
- An unused calibration unit may remain connected to the USB port while the network analyzer is performing measurements. It must be disconnected during a firmware update.
- It is safe to connect or disconnect the calibration unit while the network analyzer is operating. Never connect or disconnect the unit while data is being transferred between the analyzer and the unit. Never connect the unit during a firmware update.

9.5.5.2 Performing an Automatic Calibration

After connection and initialization of the calibration unit, perform the automatic calibration of the related test ports using the "Calibration Unit" wizard ([Cal] > "Start... (Cal Unit)"; see [Chapter 10.12.1.3, "Calibration Unit Wizard"](#), on page 454). The wizard indicates the required port (re-)connections.



The assignment between the analyzer ports and the cal unit ports can be detected automatically. If auto-detection fails (e.g. because of a high attenuation in the signal path), you can either enter the port assignment manually or connect matching port numbers and select "Default Port Assignment".

When finished, remove the test cables from the unit, connect your DUT instead and perform calibrated measurements.



Accuracy considerations

To ensure an accurate calibration, please observe the following items:

- Unused ports of the calibration unit must be terminated with a 50 Ω match.
- No adapters must be inserted between the calibration unit and the test ports of the analyzer.
- Allow for a sufficient warm-up time before starting the calibration. Refer to the specifications of the calibration unit for details.
- To ensure best accuracy, the analyzer automatically reduces the source power to -10 dBm. If the test setup contains a large attenuation, deactivate "Auto Power Setting for Cal Unit" in the "Calibration" tab of the VNA Setup dialog. Ensure an input power of -10 dBm at the ports of the calibration unit (please also refer to the specifications of the calibration unit).

NOTICE

Maximum RF input power

The maximum RF input power of the calibration unit is beyond the RF output power range of the analyzer, so there is no risk of damage if the device is directly connected to the test ports. If you use an external power amplifier, make sure that the maximum RF input power of the calibration unit quoted in the data sheet is never exceeded.

The available calibration types depend on the number of ports to be calibrated. For a single calibrated port, the reflection calibration types are available ("Refl Norm Open", "Refl Norm Short", "Refl OSM").

If 2 ports should be calibrated, the analyzer provides the following additional calibration types:

- A single full 2-port (TOSM or UOSM) calibration.
A single full 2-port (TOSM or UOSM) calibration.
- Two full one-port calibrations for the two calibrated ports.

- A one path two port calibration. The node port is the source port for the one path two port calibration (fully calibrated port).
- A transmission normalization (bidirectional, forward or reverse). "Forward" transmission normalization means that the signal direction is from port 1 to port 2.

9.5.5.3 Characterization of Calibration Units

Each calibration unit is delivered with factory characterization data which ensure an accurate calibration for all standard applications. For specific modifications of the test setup, e.g. the connection of additional adapters to a calibration unit, a modified set of characterization data (suitable for the cal unit with adapters) may be desirable. The R&S ZNL/ZNLE provides a characterization wizard which you can use to generate your own characterization data sets for (modified) R&S cal units. The characterization data can be stored in the cal unit and used for automatic calibration whenever needed.

A cal unit characterization can be performed in a frequency sweep. The network analyzer must be properly calibrated, with the reference plane at the input ports of the (modified) cal unit to be characterized.

The procedure involves the following steps:

1. Perform a calibration of your network analyzer, using the test setup and the calibration type you wish to perform with your calibration unit.
2. Connect the calibration unit to the network analyzer.
3. Access the "Characterize Cal Unit" dialog ([Cal] > "Cal Devices" > "Characterize Cal Unit...") and select "Start Characterization...".
4. Step through the "Characterization" wizard, following the instructions in the dialogs.

Dependency between calibration types and characterization data

A cal unit characterization provides full one-port (OSM) data at the selected ports plus two-port (Through) data between any pair of selected ports. The measurement of Through data is optional, however, it is required for some calibration types. The following table gives an overview.

Calibration type	Characterization data required
Refl Norm Open Refl Norm Short Refl OSM UOSM TOSM	OSM CalPort 1, OSM CalPort2 ... (all calibrated ports)
Trans Norm Both Trans Norm Forward One Path Two Ports	OSM CalPort 1, OSM CalPort2 ... (all calibrated ports), Through (between all pairs of ports)

9.5.6 Parallel Calibration of Multiple Channels

If multiple channels are configured in the active channel setup, clearly they can be calibrated one after the other, but this can be inefficient in terms of necessary reconnections of calibration standards (or calibration units).

The R&S ZNL/ZNLE offers multiple possibilities to calibrate several channels in parallel:

- Calibrate multiple channels in one go, using the same calibration type on the same ports for all channels
In this case, for each port to be calibrated the same calibration standards have to be connected. After connecting one of these standards, a calibration sweep has to be performed for each channel.
This simple mode of parallel calibration is supported from the analyzer GUI ("Calibrate all Channels" checkbox in all calibration wizards) and via remote control (see [\[SENSe:\]CORRection:COLLect:CHANnels:ALL](#) on page 841).
- Calibrate a subset of the available channels, possibly using different ports and calibration types, using **remote control**.
In this case, for each port to be calibrated a different set of calibration standards might be required. For each of these standards only a subset of the available channels might have to be swept. See [\[SENSe:\]CORRection:COLLect:CHANnels:MCTypes](#) on page 841.
This advanced mode of parallel calibration is available via **remote control only**.

9.6 Offset Parameters and De-/Embedding

The R&S ZNL/ZNLE functionality described in this section complements the calibration, compensating for the effect of known transmission lines or matching networks between the calibrated reference plane and the DUT.

9.6.1 Offset Parameters

Offset parameters compensate for the known length and loss of a (non-dispersive and perfectly matched) transmission line between the calibrated reference plane and the DUT.

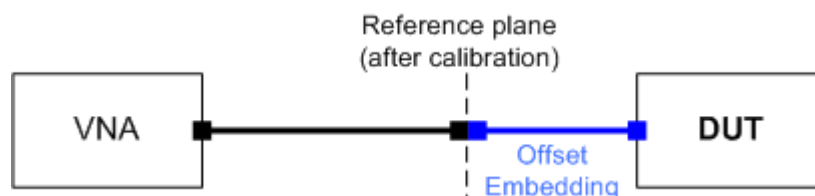

The analyzer can also auto-determine length and loss parameters, assuming that the actual values should minimize the group delay and loss across a configurable frequency range.

9.6.1.1 Definition of Offset Parameters

The *delay* is the propagation time of a wave traveling through the transmission line. The *electrical length* is equal to the delay times the speed of light in the vacuum. It is a measure for the length of the transmission line between the standard and the actual calibration plane. For a line with permittivity ϵ_r and *mechanical length* L_{mech} the delay and the electrical length are calculated as follows:

$$Delay = \frac{L_{mech} \cdot \sqrt{\epsilon_r}}{c}; \quad Electrical\ Length = L_{mech} \cdot \sqrt{\epsilon_r}$$

In the [OffsetEmbed] > "Offset" softtool tab, "Delay", "Electrical Length" and "Mech. Length" are coupled parameters. When one of them is changed, the other two are adjusted accordingly.

For a non-dispersive DUT, the delay defined above is constant over the considered frequency range and equal to the negative derivative of the phase response for the frequency (see mathematical relations). The length offset parameters compensate for a constant delay, which is equivalent to a linear phase response.

9.6.1.2 Definition of Loss Parameters

The loss is the attenuation a wave experiences when traveling through the transmission line. In logarithmic representation, it can be modeled as the sum of a constant and a frequency-dependent part, where the frequency dependence is due to the skin effect.

In the limit case, where the length of the transmission line is considered to be "almost zero", the loss is considered constant:

$$Loss(f) = Loss_{DC}$$

Otherwise, if the loss at DC and one additional frequency f_1 is known (or measured), the loss at frequency f is approximated by:

$$Loss(f) = Loss_{DC} + (Loss(f_1) - Loss_{DC}) \cdot \sqrt{\frac{f}{f_1}}$$

If in addition the loss at a second frequency f_2 is known (or measured), then the loss can be approximated by:

$$Loss(f) = Loss_{DC} + (Loss(f_1) - Loss_{DC}) \cdot \left(\frac{f}{f_1}\right)^b, \quad \text{where } b = \frac{\log_{10}\left(\left|\frac{Loss(f_1)}{Loss(f_2)}\right|\right)}{\log_{10}\left(\frac{f_1}{f_2}\right)}$$

In practice, the frequency-dependent part is often dominant, so that $Loss_{DC}$ can be set to zero. Experimentally, the loss value at DC can be determined in a separate measurement at a very low frequency ($f \rightarrow 0$).

9.6.1.3 Auto Length

The "Auto Length" function adds an electrical length offset to the active trace's receive port, such that the residual delay of the active trace (defined as the negative derivative of the phase response) is minimized across a configurable frequency range. If "Delay" is the selected trace format, the entire trace is shifted in vertical direction and centered on zero. In phase format, the "Auto Length" corrected trace shows the deviation from linear phase.

Length and delay measurement, related settings

"Auto Length" is suited for length and delay measurements on transmission lines.

1. Connect a (non-dispersive) cable to a single analyzer port no. n and measure the reflection factor S_{nn} .
2. In the [Offset Embed] > "Offset" softtool tab, select "Auto Length".

The delay is displayed in the "Delay" field, the cable length (depending on the "Velocity Factor") in the "Mech. Length" field.

It is also possible to determine cable lengths using a transmission measurement. Note that "Auto Length" always provides the **single** cable length and the delay for propagation in **one** direction.

The analyzer provides alternative ways for delay measurements:

1. Measure the reflection factor and select [Format] > "Delay".
This yields the delay for propagation in forward and reverse direction and should be approx. twice the "Auto Length" result. For transmission measurements, both results should be approx. equal.
2. Measure the reflection factor and select [Format] > "Phase". Place a marker to the trace and activate [Trace] > "Trace Statistics" > "Phase/EI Length".
This yields the delay in one direction and should be approx. equal to the "Auto Length" result.

The measurement results using trace formats and trace statistics functions depend on the selected delay aperture and evaluation range. "Auto Length" is particularly accurate because it uses all sweep points. For non-dispersive cables, aperture and evaluation range effects are expected to vanish.

Use [Mkr] > "Set by Marker" > Zero Delay at Marker to set the delay at a special trace point to zero.

Preconditions for Auto Length, effect on measured quantities and exceptions

"Auto Length" is enabled if the measured quantity contains the necessary phase information as a function of frequency, and if the interpretation of the results is unambiguous:

- A frequency sweep must be active.

- The measured quantity must be an S-parameter, ratio, wave quantity, a converted impedance or a converted admittance.

The effect of "Auto Length" on S-parameters, wave quantities and ratios is to eliminate a linear phase response as described above. The magnitude of the measured quantity is not affected. Converted admittances or impedances are calculated from the corresponding "Auto Length" corrected S-parameters. Y-parameters, Z-parameters and stability factors are not derived from a single S-parameter, therefore "Auto Length" is disabled.

Auto Length for logical ports

The "Auto Length" function can be used for balanced port configurations as well. If the active test port is a logical port, then the same length offset must be assigned to both physical ports that are combined to form the logical port. If different length offsets have been assigned to the physical ports before, they are both corrected by the same amount.

9.6.1.4 Auto Length and Loss

The "Auto Length and Loss" function determines all offset parameters at the active trace's receive port such that the residual group delay of the active trace (defined as the negative derivative of the phase response) is minimized **and** the measured loss is minimized as far as possible across a configurable frequency range.

"Auto Length and Loss" involves a two-step procedure:

- An "Auto Length" correction modifies the phase of the measured quantity, minimizing the residual group delay. The magnitude of the measured quantity is not affected.
- The automatic loss correction modifies the magnitude of the measured quantity, leaving the (auto length-corrected) phase unchanged.

Preconditions for Auto Length and Loss, effect on measured quantities and exceptions

"Auto Length and Loss" is enabled if the measured quantity contains the necessary phase information as a function of the frequency, and if the interpretation of the results is unambiguous:

- A frequency sweep must be active.
- The measured quantity must be an S-parameter, ratio, wave quantity, a converted impedance or a converted admittance.

The effect of "Auto Length and Loss" on S-parameters, wave quantities and ratios is to eliminate a linear phase response and account for a loss as described above. Converted admittances or impedances are calculated from the corresponding "Auto Length and Loss" corrected S-parameters. Y-parameters, Z-parameters and stability factors are not derived from a single S-parameter, therefore "Auto Length and Loss" is disabled.

Calculation of loss parameters

The loss is assumed to be given in terms of the DC loss Loss_{DC} , the reference frequency f_{ref} , and the loss at the reference frequency $\text{Loss}(f_{\text{ref}})$. The formula used in the Auto Loss algorithm is similar to the formula for manual entry of the loss parameters (see [Chapter 9.6.1.2, "Definition of Loss Parameters"](#), on page 266).

The result is calculated according to the following rules:

- The reference frequency f_{ref} is kept at its previously defined value (default: 1 GHz).
- The DC loss c is zero except for wave quantities and for S-parameters and ratios with maximum dB magnitude larger than -0.01 dB.
- "Auto Length and Loss" for a wave quantity centers the corrected dB magnitude as close as possible around 0 dBm.
- "Auto Length and Loss" for S-parameters and ratios centers the corrected dB magnitude as close as possible around 0 dB.

The resulting offset parameters are displayed in the [Offset Embed] > "Offset" softtool tab.

Auto Length and Loss for balanced ports

The "Auto Length and Loss" function can be used for balanced port configurations as well. If the active test port is a balanced (logical) port, then the same offset parameters must be assigned to both physical ports that are combined to form the logical port. If different offset parameters have been assigned to the physical ports before, they are both corrected by the same amount.

9.6.1.5 Fixture Compensation

"Fixture Compensation" is an automated length offset and loss compensation for test fixtures. The analyzer performs a one-port reflection measurement at each port, assuming the inner contacts of the test fixtures to be terminated with an open or short circuit.

"Fixture Compensation" complements a previous system error correction and replaces a possible manual length offset and loss correction. For maximum accuracy, it is recommended to place the reference plane as close as possible towards the outer test fixture connectors using a full n-port calibration. The "Fixture Compensation" is then carried out in a second step, it only has to compensate for the effect of the test fixture connections.

The following features can further improve the accuracy of the fixture compensation:

- "Direct Compensation" provides a frequency-dependent transmission factor (instead of a global electrical length and loss).
- "Open and Short" causes the analyzer to calculate the correction data from two subsequent sweeps. The results are averaged to compensate for errors due to non-ideal terminations.

Auto Length and Loss vs. Direct Compensation

"Auto Length and Loss" compensation is a descriptive correction type: The effects of the test fixture connection are traced back to quantities that are commonly used to characterize transmission lines.

Use this correction type if your test fixture connections have suitable properties in the considered frequency range:

- The electrical length is approximately constant.
- The loss varies due to the skin effect.

"Direct Compensation" provides a frequency-dependent transmission factor. The phase of the transmission factor is calculated from the square root of the measured reflection factor, assuming a reciprocal test fixture. The sign ambiguity of this calculated transmission factor is resolved by a comparison with the phase obtained in an Auto Length calculation. This compensation type is recommended for test fixture connections that do not have the properties described above.

A "Direct Compensation" resets the offset parameters to zero.

Open/Short vs. Open and Short compensation

A non-ideal "Open" or "Short" termination of the test fixture connections during fixture compensation impairs subsequent measurements, causing an artificial ripple in the measured reflection factor of the DUT. If you observe this effect, an "Open and Short" compensation may improve the accuracy.

"Open and Short" compensation is more time-consuming because it requires two consecutive fixture compensation sweeps for each port, the first with an open, the second with a short circuit. The analyzer automatically calculates suitable averages from both fixture compensation sweeps to compensate for the inaccuracies of the individual "Open and Short" compensations.

9.6.1.6 Application and Effect of Offset Parameters

Offset and loss parameters can be particularly useful if the reference plane of the calibration cannot be placed directly at the DUT ports, e.g. because the DUT has non-coaxial ports and can only be measured in a test fixture. Offset parameters can also help to avoid a new complete system error correction if a cable with known properties has to be included in the test setup.

- A positive length offset moves the reference plane of the port towards the DUT, which is equivalent to deembedding the DUT by numerically removing a (perfectly matched) transmission line at that port.
- A negative offset moves the reference plane away from the DUT, which is equivalent to embedding the DUT by numerically adding a (perfectly matched) transmission line at that port.

The offset parameters are also suited for length and delay measurements; see [Chapter 9.6.1.3, "Auto Length"](#), on page 267. In contrast to the embedding/deembedding functions (see [Chapter 9.6.2, "Embedding and Deembedding"](#), on page 271) the parameters cannot compensate for a possible mismatch in the test setup.

Each offset parameter is assigned to a particular port. The delay parameters affect the phase of all measured quantities related to this port; the loss parameters affect their magnitude. An offset at port 1 affects the S-parameters S_{11} , S_{21} , S_{12} , S_{31} ... Some quantities (like the Z-parameters) depend on the whole of all S-parameters, so they are all more or less affected when one S-parameter changes due to the addition of an offset length.



To account for the propagation in both directions, the phase shift of a reflection parameter due to a given length offset is twice the phase shift of a transmission parameter. If, at a frequency of 300 MHz, the electrical length is increased by 250 mm ($\lambda/4$), then the phase of S_{21} increases by 90 deg, whereas the phase of S_{11} increases by 180 deg.

Equivalent relations hold for the loss.

If the trace is displayed in "Delay" format, changing the offset parameters simply shifts the whole trace in vertical direction.

The sign of the phase shift is determined as follows:

- A positive offset parameter causes a positive phase shift of the measured parameter and therefore reduces the calculated group delay.
- A negative offset parameter causes a negative phase shift of the measured parameter and therefore increases the calculated group delay.

9.6.1.7 Offset Parameters for Balanced Ports

The offset parameters can be used for balanced port configurations:

- Offset parameters must be assigned to both physical ports of a logical port.
- "Auto Length" corrects the length offset of both physical ports of a logical port by the same amount.

9.6.2 Embedding and Deembedding

The R&S ZNL/ZNLE allows you to define virtual networks to be added to/removed from the measurement circuit for a DUT with single ended or balanced ports. This concept is referred to as embedding/deembedding.

The embedding/deembedding function has the following characteristics:

- Embedding and deembedding can be combined with balanced port conversion: the (de-)embedding function is available for single ended and balanced ports.
- A combination of four-port and two-port networks (not necessarily both) can be applied to balanced ports; two-port networks can be applied to single ended ports.
- A combination of four-port and two-port networks can be applied to any pair of single-ended ports. Moreover it is possible to combine several port pairs in an arbitrary order (port pair de-/embedding).
- Single-ended and/or balanced port (de-)embedding can be combined with ground loop (de-)embedding. A ground loop models the effect of a non-ideal ground connection of the DUT.

- Transformation networks can be defined by a set of S-parameters stored in a Touchstone file or by an equivalent circuit with lumped elements.
- The same networks are available for embedding and deembedding.

9.6.2.1 Embedding a DUT

To be integrated in application circuits, high-impedance components like Surface Acoustic Wave (SAW) filters are often combined with a matching network. To obtain the characteristics of a component with an added matching network, both must be integrated in the measurement circuit of the network analyzer.

The idea of virtual embedding is to simulate the matching network and avoid using physical circuitry so that the analyzer ports can be directly connected to the input and output ports of the DUT. The matching circuit is taken into account numerically. The analyzer measures the DUT alone but provides the characteristics of the DUT, including the desired matching circuit.

This method provides a number of advantages:

- The measurement uncertainty is not impaired by the tolerances of real test fixtures.
- There is no need to fabricate test fixtures with integrated matching circuits for each type of DUT.
- Calibration can be performed at the DUT's ports. If necessary, (e.g. for compensating for the effect of a test fixture) it is possible to shift the calibration plane using length offset parameters.

9.6.2.2 Deembedding a DUT

Deembedding and embedding are inverse operations: A deembedding problem is given if an arbitrary real network connected to the DUT is to be virtually removed to obtain the characteristics of the DUT alone. Deembedding is typically used for DUTs which are not directly accessible because they are inseparably connected to other components, e.g. for MMICs in a package or connectors soldered to an adapter board.

To be numerically removed, the real network must be described by a set of S-parameters or by an equivalent circuit of lumped elements. Deembedding the DUT effectively extends the calibration plane towards the DUT ports, enabling a realistic evaluation of the DUT without the distorting network. Deembedding can be combined with length offset parameters; see [Chapter 9.6.1, "Offset Parameters"](#), on page 265.

The simplest case of single port deembedding can be depicted as follows:

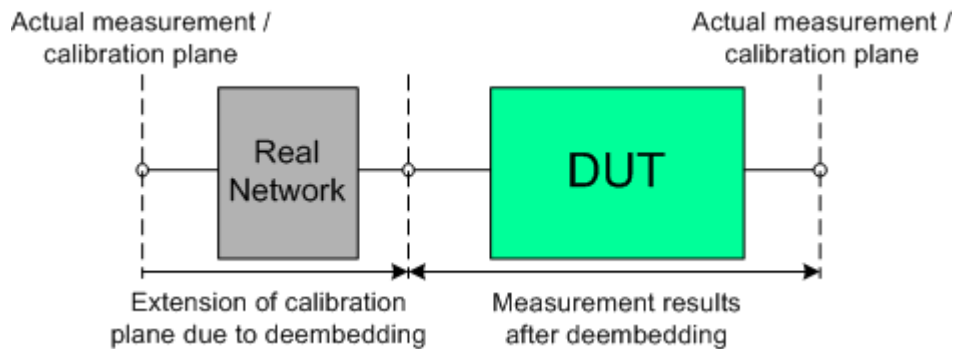

9.6.2.3 Circuit Models for 2-Port Networks

The lumped element 2-port transformation networks for (de-)embedding consist of the following two basic circuit blocks:

- a capacitor connected in parallel with a resistor
- an inductor connected in series with a resistor

The 2-port transformation networks comprise all possible combinations of 2 basic blocks, where either one block represents a serial and the other a shunt element or both represent shunt elements. In the default setting the resistors are not effective, since the serial resistances are set to 0Ω , the shunt resistances are set to $10 \text{ M}\Omega$ and the shunt inductances are set to 0 Siemens .

The first network is defined by its S-parameters stored in an imported two-port Touchstone file (*.s2p). No additional parameters are required.

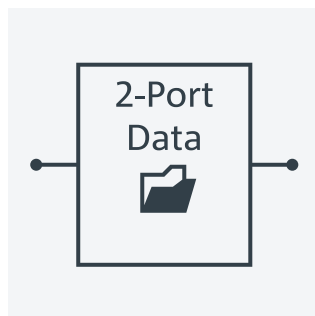

The following networks are composed of a serial capacitance C or inductance L (as seen from the test port), followed by a shunt L or C. They are named Serial C, Shunt L / Serial L, Shunt C / Serial C, Shunt C / Serial L, Shunt L.

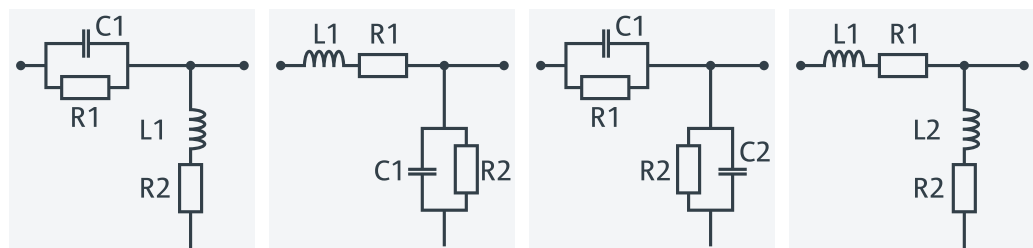

The following networks are composed of a shunt C or L (as seen from the analyzer port), followed by a serial C or L. They are named *Shunt C*, *Serial L / Shunt L*, *Serial C / Shunt C*, *Serial C / Shunt L*, *Serial L*.

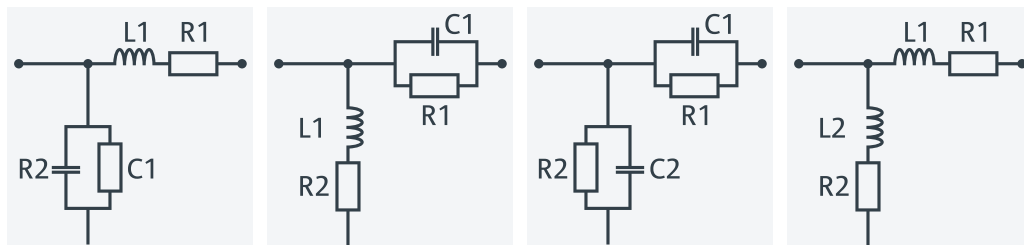

At the GUI, the "capacitance $C_{<i>i</i>}$ in parallel with resistance $R_{<i>i</i>}$ " circuit blocks can be replaced by equivalent "capacitance $C_{<i>i</i>}$ in parallel with conductance $G_{<i>i</i>}$ " circuit blocks.

In addition, there is also a *Shunt L*, *Shunt C* circuit model available, where the shunt C is defined as a capacitance C in parallel with a conductance G:

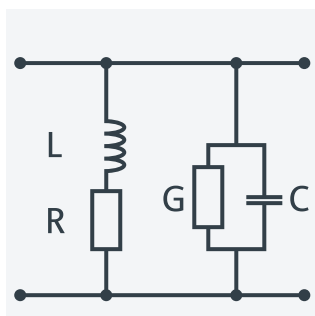

9.6.2.4 Circuit Models for 4-Port Networks

The lumped element 4-port transformation networks for (de-)embedding consist of the following two basic circuit blocks:

- A capacitor C connected in parallel with a resistor.
- An inductor L connected in series with a resistor.

The transformation networks comprise various combinations of 3 basic circuit blocks, where two blocks represent serial elements, the third a shunt element. In the default setting the resistors are not effective, since the serial R_s are set to 0Ω , the shunt R_s are set to $10 \text{ M}\Omega$. Moreover, the serial elements can be replaced by imported 2-port S-parameters, or the entire transformation network can be described by imported 4-port S-parameters.

The first network is defined by its S-parameters stored in an imported four-port Touchstone file (* .s4p). No additional parameters are required.

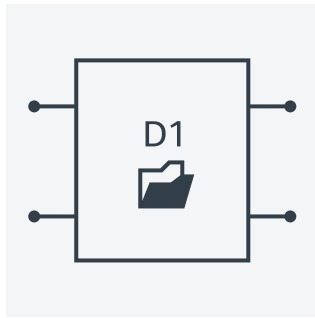

The following networks are composed of a shunt C or L and two serial elements, described by imported 2-port S-parameters. They are named Serial 2-port, Shunt C / Serial 2-port, Shunt L / Shunt L, Serial 2-port / Shunt C, Serial 2-port.

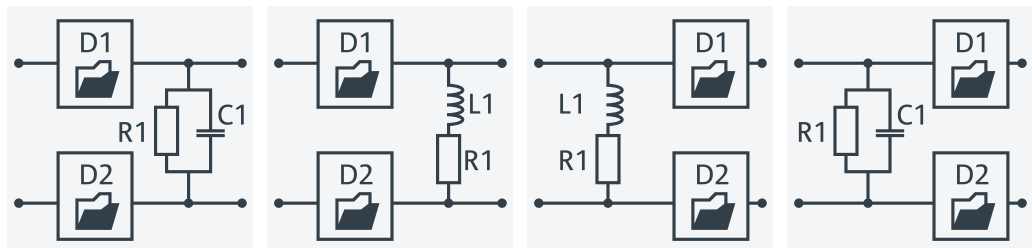

The following networks are composed of two serial Cs or Ls (as seen from the analyzer test port), followed by a shunt C or L. They are named Serial Cs, Shunt L / Serial Ls, Shunt C / Serial Cs, Shunt C / Serial Ls, Shunt L.

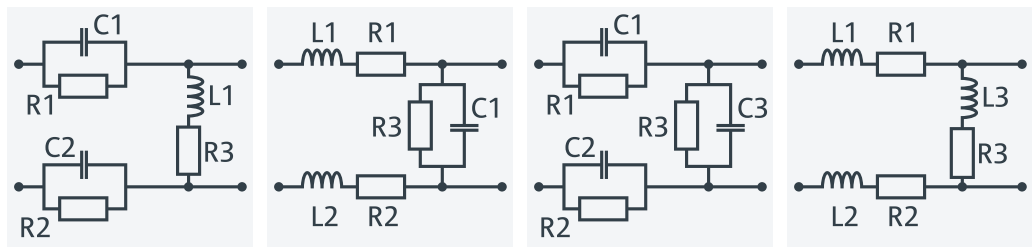

The following networks are composed of a shunt C or L (as seen from the analyzer test port), followed by two serial Cs or Ls. They are named Shunt L, Serial Cs / Shunt C, Serial Ls / Shunt C, Serial Cs / Shunt L, Serial Ls.

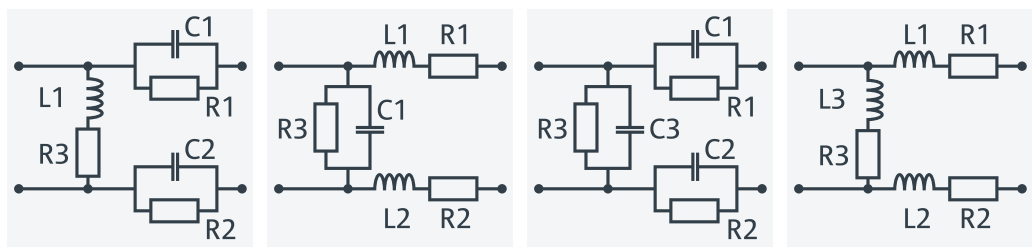



Since FW version 1.93, the "capacitance $C_{i>}$ in parallel with resistance $R_{i>}$ " circuit blocks can alternatively be represented as "capacitance $C_{i>}$ in parallel with conductance $G_{i>}$ " circuit blocks.

9.6.2.5 Port Pair De-/Embedding

Port pair de-/embedding extends the functionality of balanced port de-/embedding to pairs of single-ended physical ports. The analyzer uses the 4-port transformation networks known from balanced port de-/embedding, however, each transformation network is assigned to an arbitrary pair of (single-ended) physical ports.

A simple circuit which can be modeled using port pair (de-)embedding is a circuit (e.g. a resistance) between two ports of a DUT. To obtain the circuit in the following figure, select port pair 1,2 and the Serial Ls, Shunt L transformation network with all inductances set to zero ($L1 = L2 = L3 = 0$ H) and $R1 = R2 = 0$ Ω .

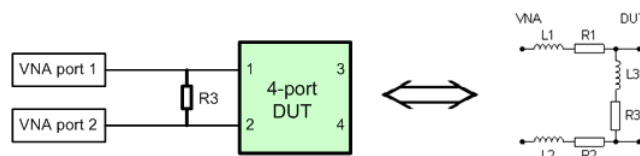

To model a general (de-)embedding network for ports 1 and 2, select port pair 1, 2 and a 4-Port Touchstone file.

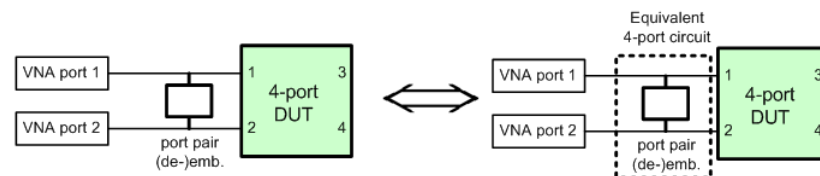

The R&S ZNL/ZNLE FW handles Port Pair De-/Embedding as a special case of [Port Set De-/Embedding](#).

9.6.2.6 Port Set De-/Embedding

The port set de-/embedding feature allows de-/embedding a linear $2m$ -port network connecting m physical VNA ports to m physical DUT ports ($m \geq 2$).

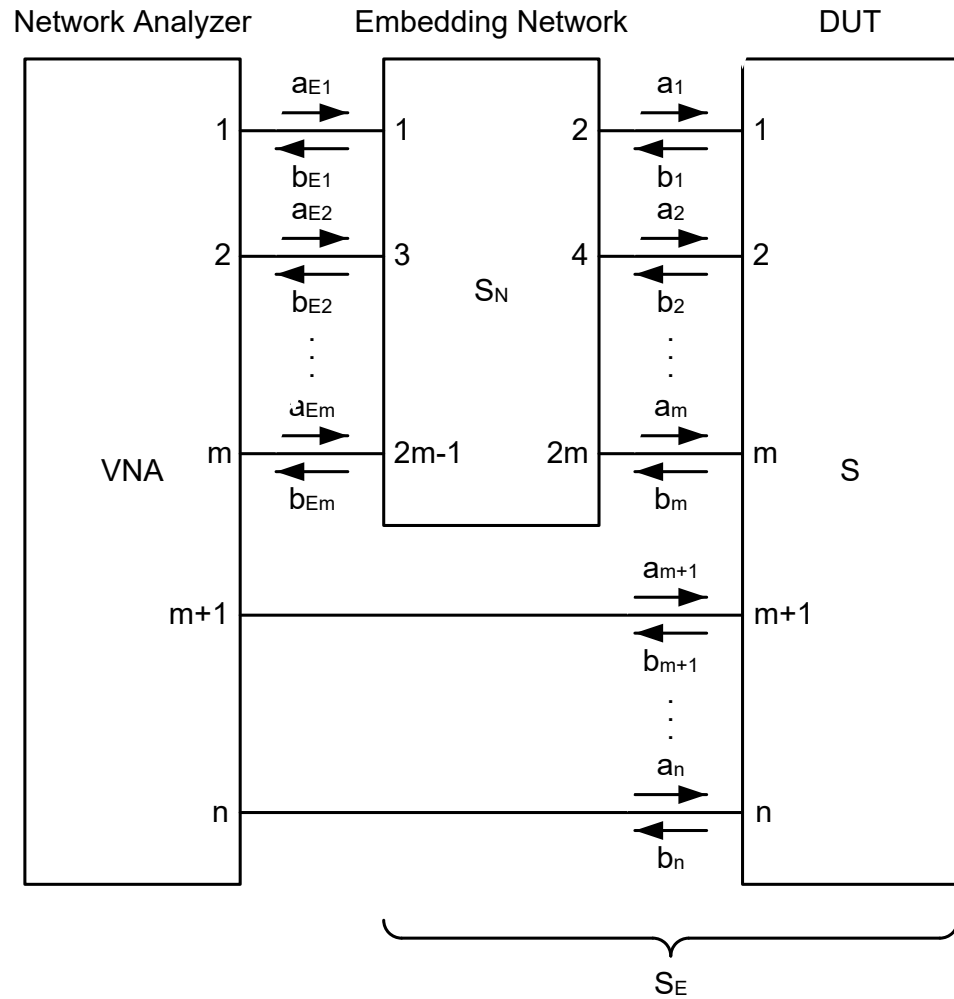
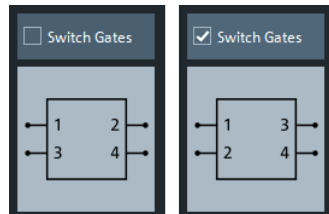

Figure 9-4: Port Set De-/Embedding

As shown in section [Combining Several De-/Embedding Networks](#), port set deembedding is calculated after single-ended deembedding, and the port set embedding step precedes single ended embedding. It is possible to combine a sequence of port sets for deembedding (embedding), each port set having its own transformation network. The effect of port set de-/embedding depends on the port sets themselves but also on their order. The same physical ports can be used repeatedly in different port sets; it is also possible to use the same port set repeatedly.



- For the R&S ZNL/ZNLE, each port set can consist of $m = 2$ ports
- For these port pairs, the de-/embedding network can be defined either via lumped element model (possibly in combination with s2p Touchstone files) or via a s4p Touchstone file, see [Chapter 9.6.2.5, "Port Pair De-/Embedding"](#), on page 276.
- In case the port number conventions of the loaded Touchstone file differ from the numbering scheme depicted in [Figure 9-4](#), it is possible to "Switch Gates". The analyzer interchanges the port numbers when loading the file.



9.6.2.7 Ground Loop De-/Embedding

A ground loop models the effect of a non-ideal ground connection of the DUT causing a difference in potential between the analyzer's and the DUT's ground reference. A typical and often unavoidable source of ground loops is the parasitic inductance of the ground contacts.

In contrast to the 2-port de-/embedding networks, the ground loop represents a single-wire connection that can be described by a one-port S-matrix. On the other hand, the ground loop de-/embedding algorithm for an n-port DUT involves matrix operations which are based on the complete uncorrected single-ended $n \times n$ S-matrix.

The Ground Loop De-/Embedding can be specified via Touchstone s1p file or by parametrizing one of the lumped element models "Shunt L", "Shunt C".

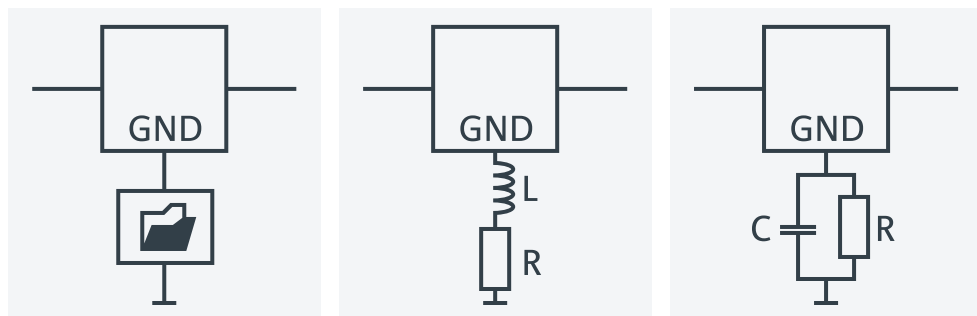

9.6.2.8 Differential Match Embedding

Differential Match Embedding allows you to simulate the characteristics of balanced DUT ports whose differential mode is balance-unbalance converted and then connected to a port-specific matching circuit.

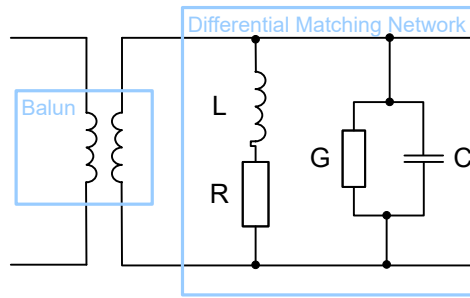

In contrast to standard balanced embedding (4-port), the matching circuit is only applied to the differential mode port (2-port). It can be specified via a Touchstone s2p file or by parametrizing a lumped "Shunt L, Shunt C" element model.

9.6.2.9 Combining Several De-/Embedding Networks

The R&S ZNL/ZNLE allows you to select a combination of networks to be numerically added/removed at different layers

- 2-port networks at single ended physical ports
- 4-port networks at pairs of single ended physical ports
- 4-port networks at balanced logical ports
- 1-port ground loop networks
- 2-port differential match embedding networks at balanced logical ports

The different steps for deembedding and embedding are carried out in the following order:

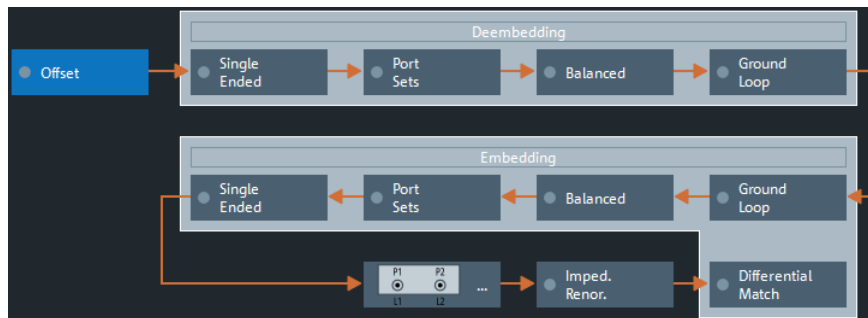

Figure 9-5: De-/Embedding calculation flow

This means that the real networks are removed before virtual networks are added.

The (de-)embedding steps are carried out in the following order:

1. Single Ended Deembedding: every physical port can be deembedded from a single 2-port network
2. Port Set Deembedding: every port pair can be deembedded from a sequence of 4-port networks.

3. Balanced Deembedding: every balanced logical port can be deembedded from a single 4-port network
4. Ground Loop Deembedding: the DUT's ground connection can be deembedded from a single 1-port network
5. Ground Loop Embedding: the DUT's ground connection can be embedded in a single 1-port network
6. Balanced Embedding: every balanced logical port can be embedded in a single 4-port network
7. Port Set Embedding: every port set can be embedded in a sequence of 4-port networks.
8. Single Ended Embedding: every physical port can be embedded in a single 2-port network
9. Differential Match Embedding: the differential mode of a balanced logical port can be embedded in a single 2-port network

1. Initial situation: DUT embedded in 2-port and 4-port networks (only 1 port shown)

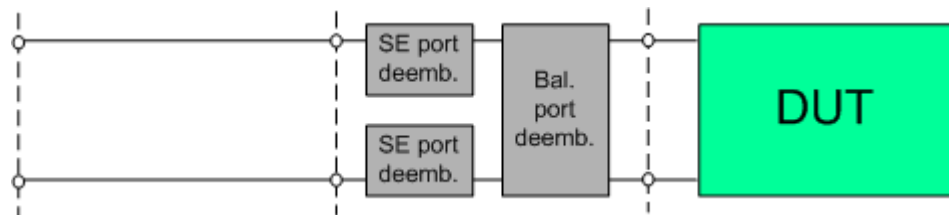

2. Single ended deembedding

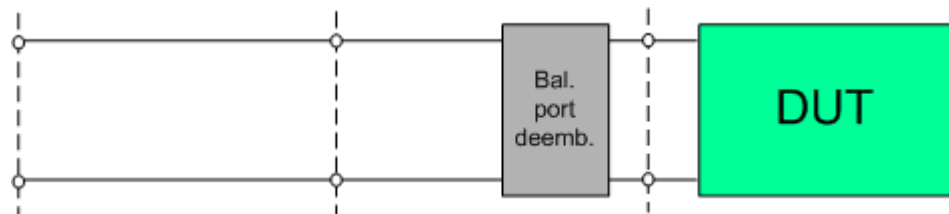

3. Balanced port deembedding



4. Balanced port embedding



5. Single ended port embedding



9.7 Optional Extensions and Accessories

The instrument can be upgraded with various hardware and software options, providing enhanced flexibility and an extended measurement functionality. The equipped options are listed in the "System Configuration" dialog ([Setup] > "System Config").

For a complete list of options, accessories, and extras refer to the product brochure or to the "Options" section of the R&S ZNL/ZNLE product pages on the Internet.

The following sections provide an introduction to the software and hardware options described in this documentation.



- For the R&S ZNL, some hardware and software options depend on the [Spectrum Analyzer Function](#), i.e. these options are only available if the R&S ZNL is equipped with the spectrum analysis hardware option B1. For a description of these options, refer to the Spectrum Mode user manual.
For the R&S ZNLE and the current R&S ZNL14 and R&S ZNL20 models (order nos. 1323.0012.14 and 1323.0012.20), a spectrum analysis option is **not available**.
- The additional hardware options are a subset of the hardware options of the identically constructed spectrum analyzer R&S FPL100x. For this reason, they are prefixed by R&S FPL1 (instead of R&S ZNL/ZNLE).
- For the R&S ZNLE, there are only a few software and hardware options available. See:
 - [Chapter 9.7.1, "Time Domain Analysis"](#), on page 282
 - [Chapter 9.7.2, "Distance-to-Fault Measurements"](#), on page 288
 - [Chapter 9.7.10, "GPIB Interface"](#), on page 292
 - [Chapter 9.7.11, "Broadband Limiter"](#), on page 293
 - [Chapter 9.7.7, "Lower Start Frequency for R&S ZNLE"](#), on page 291

9.7.1 Time Domain Analysis

Option R&S ZNL-K2

The network analyzer measures and displays complex S-parameters and other quantities as a function of the frequency. The measurement results can be filtered and mathematically transformed to obtain the time domain representation, which often gives a clearer insight into the characteristics of the DUT.

Time domain transforms can be calculated in band pass or low pass mode. For the latter, the analyzer offers the impulse and step response as two alternative transformation types. A wide selection of windows can be used to optimize the time domain response and suppress side lobes due to the finite sweep range. Moreover, it is possible to eliminate unwanted responses using a time gate and transform the gated result back into the frequency domain.

For a detailed discussion of the time domain transformation including many examples, refer to the application note 1EP83 which is available on the R&S internet at <http://www.rohde-schwarz.com/appnotes/1EP83>.



This option is also available for the R&S ZNLE.

Trace selection

Select a reflection parameter S_{ii} to perform a time domain reflectometry (TDR) measurement, e.g. to detect cable faults. To measure the impedance of a network, you can select a [converted impedance parameter](#) $Z_{\leftarrow S_{ii}}$.

Select a transmission parameters S_{ij} ($i \neq j$) to perform a time domain transmission (TDT) measurement, e.g. for measuring antennas.



For TDR traces and if distance is used as the x axis, the x value indicates the **one-way** path to the reflection.

9.7.1.1 Chirp z-Transformation

The Chirp z-transformation that the analyzer uses to compute the time domain response is an extension of the (inverse) Fast Fourier Transform (FFT). Compared to the FFT, the number of sweep points is arbitrary (not necessarily an integer power of 2), but the computation time is increased by approx. a factor of 2. This increased computation time is usually negligible compared to the sweep times of the analyzer.

The following properties of the Chirp z-transformation are relevant for the analyzer settings:

- The frequency points must be equidistant.
- The time domain response is repeated after a time interval which is equal to $\Delta t = 1/\Delta f$, where Δf is the spacing between two consecutive sweep points in the frequency domain. For a sweep span of 4 GHz and 201 equidistant sweep points, $\Delta f = 4$

$\text{GHz}/200 = 2 * 10^7 \text{ Hz}$, so that $\Delta t = 50 \text{ ns}$. Δt is termed measurement range (in time domain) or unambiguous range.

Additional constraints apply if the selected Chirp z-transformation is a lowpass transformation.

9.7.1.2 Band Pass and Low Pass Mode

The analyzer provides two different types of time domain transforms:

- **Band pass mode:** The time domain transform is based on the measurement results obtained in the sweep range between any set of positive start and stop values. The sweep points must be equidistant. No assumption is made about the measurement point at zero frequency (DC value). The time domain result is complex, with an undetermined phase depending on the delay of the signal.
- **Low pass mode:** The measurement results are continued towards $f = 0$ (DC value) and mirrored at the frequency origin so that the effective sweep range (and thus the response resolution) is more than doubled. Together with the DC value, the condition of equidistant sweep points implies that the frequency grid must be harmonic. Due to the symmetry of the trace in the frequency domain, the time domain result is harmonic.

See also [Chapter 9.7.1.4, "Harmonic Grid"](#), on page 284.

Two different types of response are available in low pass mode; see below.

Table 9-11: Comparison of band pass and low pass modes

Transform type	Band pass	Low pass
Advantages	Easiest to use: works with any set of equidistant sweep points	Higher response resolution (doubled) Includes information about DC value Real result Impulse and step response
Restrictions	No step response Undetermined phase	Needs harmonic grid
Use for...	Scalar measurements where the phase is not needed DUTs that do not operate down to $f = 0$ (e.g. pass band or high pass filters)	Scalar measurements where the sign is of interest DUTs with known DC value

Impulse and step response

In low pass mode, the analyzer can calculate two different types of responses:

- The impulse response corresponds to the response of a DUT that is stimulated with a short pulse.
- The step response corresponds to the response of a DUT that is stimulated with a voltage waveform that transitions from zero to unity.

The two alternative responses are mathematically equivalent; the step response can be obtained by integrating the impulse response:

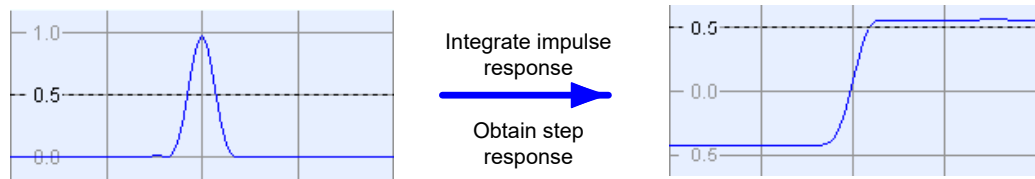

The step response is recommended for impedance measurements and for the analysis of discontinuities (especially inductive and capacitive discontinuities). The impulse response has an unambiguous magnitude and is therefore recommended for most other applications.

9.7.1.3 Windows in the Frequency Domain

The finite sweep range in a frequency domain measurement with the discontinuous transitions at the start and stop frequency broadens the impulses and causes side lobes (ringing) in the time domain response. The windows offered in the "Define Transform" dialog can reduce this effect and optimize the time domain response. The windows have the following characteristics:

Table 9-12: Properties of frequency windows

Window	Side lobe suppression	Relative impulse width	Best for...
No Profiling (Rectangle)	13 dB	1	–
Low First Side lobe (Hamming)	43 dB	1.4	Response resolution: separation of closely spaced responses with comparable amplitude
Normal Profile (Hann)	32 dB	1.6	Good compromise between pulse width and side lobe suppression
Steep Falloff (Bohman)	46 dB	1.9	Dynamic range: separation of distant responses with different amplitude
Arbitrary Side lobes (Dolph-Chebyshev)	User defined between 10 dB and 120 dB	1.2 (at 32 dB side lobe suppression)	Adjustment to individual needs; tradeoff between side lobe suppression and impulse width

9.7.1.4 Harmonic Grid

A harmonic grid is formed by a set of equidistant frequency points f_i ($i = 1 \dots n$) with spacing Δf and the additional condition that $f_1 = \Delta f$. In other words, all frequencies f_i are set to harmonics of the start frequency f_1 .

If a harmonic grid, including the DC value ($f = 0$), is mirrored to the negative frequency range, the result is again an equidistant grid.

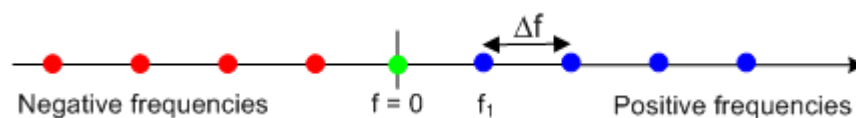

The point symmetry with respect to the DC value makes harmonic grids suitable for lowpass time domain transformations.

Visualization of the harmonic grid algorithms

The R&S ZNL provides three different algorithms for harmonic grid calculation. The three harmonic grids have the following characteristics:

- Keep "Stop Frequency and Number of Points" means that the stop frequency and the number of sweep points is maintained. The sweep points are redistributed across the range between the minimum frequency of the analyzer and the stop frequency; the step width can be increased.

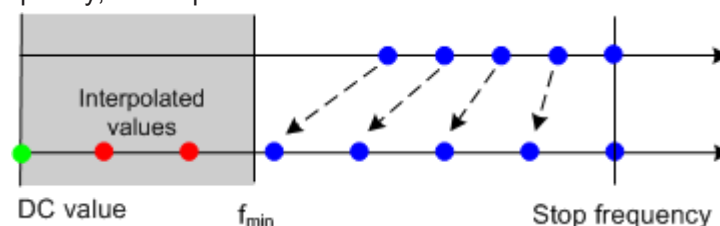

- Keep "Frequency Gap and Number of Points" means that the number of sweep points and their relative spacing is maintained. If the start frequency of the sweep is sufficiently above the f_{min} , the entire set of sweep points is shifted towards lower frequencies so that the stop frequency is decreased.

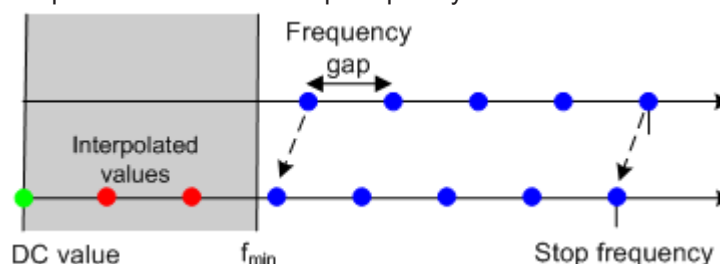

If the start frequency of the sweep is close to f_{min} , then the sweep points can have to be shifted towards higher frequencies. If the last sweep point of the calculated harmonic grid exceeds the maximum frequency of the analyzer, then an error message is displayed, and another harmonic grid algorithm must be used.

- Keep "Stop Frequency and Approximate Frequency Gap" means that the stop frequency is maintained and the number of sweep points is increased until the range between f_{min} and the stop frequency is filled. The frequency gap is approximately maintained.

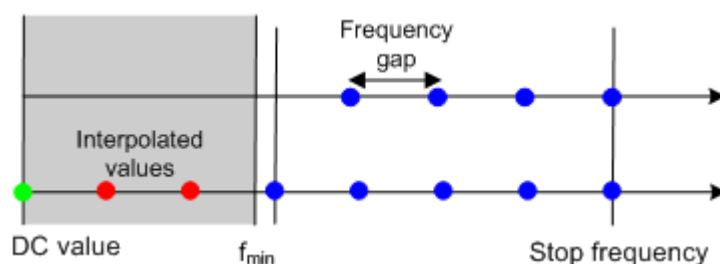

The figures above are schematic and do not comply with the conditions placed on the number of sweep points and interpolated/extrapolated values.



The harmonic grids cannot be calculated for any set of sweep points. If the minimum number of sweep points is smaller than 5, then the interpolation/extrapolation algorithm for additional sweep points does not work. The same is true if the number of sweep points or stop frequency exceeds the upper limit. Besides, the ratio between the sweep range and the interpolation range between $f = 0$ and $f = f_{\min}$ must be large enough to ensure accurate results. If the sweep range for the harmonic grid exceeds the frequency range of the current system error correction, a warning is displayed.

Finding the appropriate algorithm

The three types of harmonic grids have different advantages and drawbacks. Note that for a bandpass transformation the grid parameters have the following effect:

- A wider sweep range (i.e. a larger bandwidth) increases the time domain resolution.
- A smaller frequency gap extends the unambiguous range.
- A larger number of points increases the sweep time.

With default analyzer settings, the differences between the grid types are small. The following table helps you find the appropriate grid.

Table 9-13: Properties of grid types

Grid type: Keep	Sweep time	Time domain resolution	Unambiguous range	Algorithm fails if...
Stop freq. and no. of points	→	↑	↓	–
Freq. gap and no. of points	→	→	→	Stop frequency beyond upper frequency limit
Stop freq. and approx. freq. gap	↑	↑	→	Number of sweep points beyond limit

9.7.1.5 Time Gates

A time gate is used to eliminate unwanted responses that appear on the time domain transform. An active time gate acts on the trace in time domain and in frequency domain representation.

The properties of the time gates are analogous to the properties of the frequency domain windows. The following table gives an overview:

Table 9-14: Properties of time gates

Window	Side lobe suppression	Passband ripple	Best for...
Steepest Edges (Rectangle)	13 dB	0.547 dB	Eliminate small distortions in the vicinity of the useful signal, if demands on amplitude accuracy are low
Steep Edges (Hamming)	43 dB	0.019 dB	Good compromise between edge steepness and side lobe suppression

Window	Side lobe suppression	Passband ripple	Best for...
Normal Gate (Hann)	32 dB	0.032 dB	Good compromise between edge steepness and side lobe suppression
Maximum Flatness (Bohman)	46 dB	0 dB	Maximum attenuation of responses outside the gate span
Arbitrary Gate Shape (Dolph-Chebyshev)	User defined between 10 dB and 120 dB	0.071 dB	Adjustment to individual needs; tradeoff between side lobe suppression and edge steepness

Time-Gated Frequency Domain Trace

The trace in the frequency domain depends on the state of the "Time Gate":

- If the gate is disabled, the frequency domain (FD) trace corresponds to the measured sweep results before the time-domain transformation.
- If the gate is enabled, the displayed frequency domain trace is calculated from the time domain (TD) trace which is gated and transformed back into the frequency domain.

The analyzer uses fixed "No Profiling (Rectangle)" window settings to transform the measured trace into time domain. The TD trace is gated using the selected time gate. The gated trace is transformed back into frequency domain using a "No Profiling (Rectangle)" window.

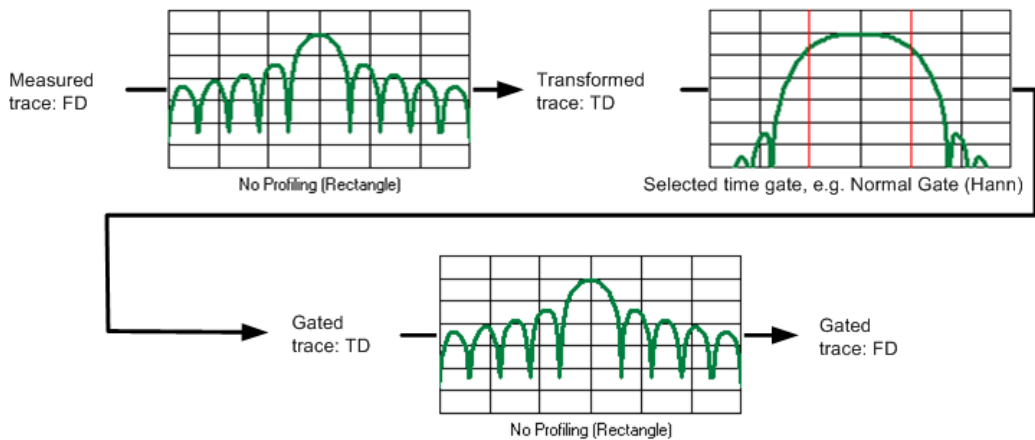

The shape, width and position of the time gate affect the gated frequency domain trace. The window type selection in the "Define Transform" dialog is ignored. The selected window is used again when the TD trace is displayed ("Time Domain: On").

The rectangular "No Profiling (Rectangle)" windows minimize numerical inaccuracies near the boundaries of the measured frequency span. In the limit where the effect of the time gate vanishes (e.g. a gate of type "Notch" and a very small width), the time gated trace is equal to the original measured trace.

9.7.2 Distance-to-Fault Measurements

Option R&S ZNL-K3

With option K3 "Distance-to-Fault", the R&S ZNL/ZNLE can locate faults and discontinuities on cables and transmission lines.



This option is also available for the R&S ZNLE.

Faults produce peaks on the impulse response (in the time domain) that is calculated from the measured reflection S-parameter trace via inverse Fourier transformation. The distance between the reference plane and the fault can then be calculated from the propagation time, accounting for the electrical properties of the transmission line. Moreover it is possible to define the peaks to be considered as being caused by a fault.

The following example shows the reflection at the end of a faultless open cable connected to test port 2. A full one-port calibration ensures that the distance is measured from the test port position (reference plane = distance zero). The horizontal position of marker "M2" corresponds to the cable length of 1417 mm, the additional peak at position "M1" is due to a bad connection between the cable and the test port.

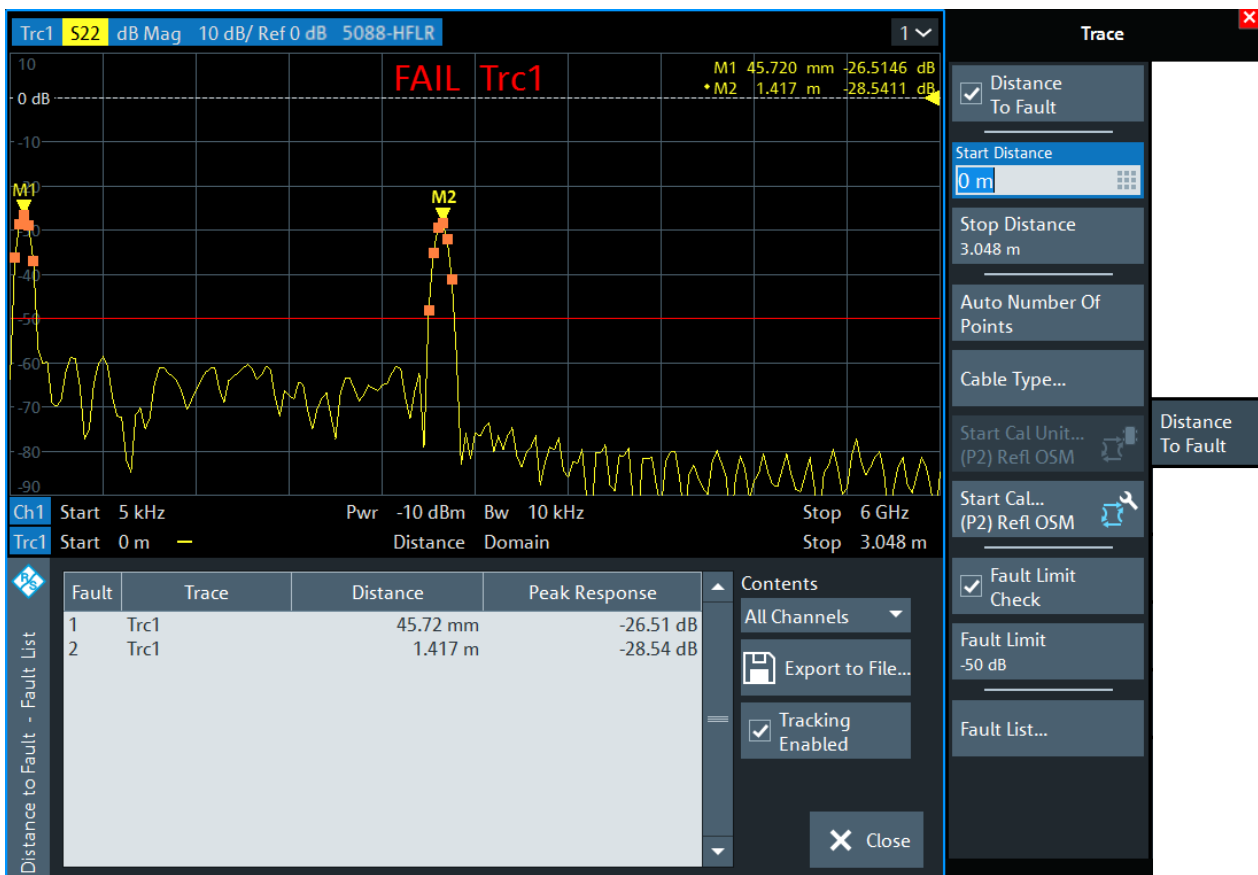

Adjust the frequency sweep to the length of the transmission line and the expected distance to fault:

- The maximum distance that can be measured is proportional to the number of sweep points. The larger the number of sweep points, the longer the maximum distance between the calibrated reference plane and the fault to be located.
- The maximum distance that can be measured is inversely proportional to the frequency span. The smaller the frequency span, the longer the maximum distance between the calibrated reference plane and the fault to be located. However, a smaller frequency span comes at the cost of a coarser distance resolution.

The R&S ZNL/ZNLE can automatically determine a suitable number of sweep points for a given maximum distance to fault ("Auto Number of Points"). Moreover it is possible to define which of the peaks are considered as being due to a fault, and to draw up and export a list of the detected faults.



A more flexible approach with additional configuration possibilities is available with time domain option R&S ZNL-K2 (see [Chapter 9.7.1, "Time Domain Analysis"](#), on page 282).

9.7.3 Spectrum Analyzer Function

Option R&S ZNL3|4|6-B1

If the "Spectrum Analyzer" hardware option R&S ZNL3|4|6-B1 is installed, you can use the R&S ZNL3|4|6 to perform signal and spectrum analysis measurements in the instrument's respective frequency range. See the data sheet and the "Spectrum Analysis" user manual for further information.



- This hardware option is not available for the R&S ZNLE. For the R&S ZNL, it can be retrofitted at Rohde&Schwarz service.
- The following additional options are only available if the R&S ZNL is equipped with the spectrum analysis option:
 - R&S FPL1-B40 "40 MHz Analysis Bandwidth" (keycode option; applies to spectrum measurements only)
 - R&S FPL1-K7 "Analog Demodulation AM/FM/PM" (software license)
 - R&S FPL1-K30 "Noise Figure Measurements" (software license)
- For the current R&S ZNL14 and R&S ZNL20 models (order nos.1323.0012.14 and 1323.0012.20), a B1 option and all other dependent options **are not available** and **will not be available** in future.
Successor models, which will support the B1 option and all other dependent options will be available at a later stage.
- The following R&S FPL1 options can also be used without the spectrum analysis option:
 - R&S FPL1-B4 [OCXO Frequency Reference](#)
 - R&S FPL1-B5 [Additional Interfaces](#)
 - R&S FPL1-B10 [GPIB Interface](#)
 - R&S FPL1-B30 [DC Power Supply 12/24 V](#)
 - R&S FPL1-B31 [Internal Li-Ion Batteries](#)

Options R&S FPL1-B19, R&S FPL1-B22 and R&S FPL1-B25 are available for the R&S FPL100x only. They are **not** supported on the R&S ZNL/ZNLE.

9.7.4 Additional Removable PC Board with SSD

Option R&S ZNL-B19

Option R&S ZNL/ZNLE-B19 provides an additional removable PC board for the R&S ZNL, including an SSD with operating system and VNA firmware.



For the R&S ZNLE, this option is not available.

9.7.5 Extended Power Range

Option R&S ZNL3|4|6|14|20-B22

For the R&S ZNL3|4|6|14|20, hardware option R&S ZNL3|4|6|14|20-B22 reduces the minimum receive power down to -40 dBm.



This option is not available for the R&S ZNLE.

9.7.6 Receiver Step Attenuators

Options R&S ZNL3|4|6|14|20-B31 and R&S ZNL3|4|6|14|20-B32

Receiver step attenuators are used to adjust the received signal levels to the input level range of the analyzer to avoid damage to the instrument, e.g. if the DUT is a power amplifier.

The attenuation values can be set between 0 dB and 30 dB (in 10 dB steps); see "[Step Attenuators](#)" on page 298. The following step attenuators are available:

Table 9-15: R&S ZNL

Analyzer type	Port 1	Port 2
R&S ZNL3	R&S ZNL3-B31	R&S ZNL3-B32
R&S ZNL4	R&S ZNL4-B31	R&S ZNL4-B32
R&S ZNL6	R&S ZNL6-B31	R&S ZNL6-B32
R&S ZNL14	R&S ZNL14-B31	R&S ZNL14-B32
R&S ZNL20	R&S ZNL20-B31	R&S ZNL20-B32



- Receiver step attenuators are not available for the R&S ZNLE.
- Receiver step attenuators for the R&S ZNL can be retrofitted at Rohde & Schwarz service.

9.7.7 Lower Start Frequency for R&S ZNLE

Option R&S ZNLE-B100

Hardware option R&S ZNLE-B100 reduces the lower frequency bound of a R&S ZNLE from 1 MHz down to 100 kHz.



- The frequency range of a R&S ZNL always starts at 5 kHz
- Option R&S ZNLE-B100 can be retrofitted at Rohde & Schwarz service.

9.7.8 OCXO Frequency Reference

Option R&S FPL1-B4

An optional OCXO improves the static frequency accuracy of the R&S ZNL. For details, refer to the data sheet.



This option is not available for the R&S ZNLE. For the R&S ZNL, it can be retrofitted by Rohde&Schwarz service.

9.7.9 Additional Interfaces

Option R&S FPL1-B5

This user-retrofitable plugin-unit provides the following additional interfaces:

- IF/Video/Demod out (usable in "Spectrum Mode" only)
- [Aux. Port](#) ("VNA Mode") / Aux port ("Spectrum Mode")
- Noise source control ("Spectrum Mode" only)
- Power sensor
- AF output ("Spectrum Mode" only)



- This option is not available for the R&S ZNLE.
- The VNA-/Spectrum specific interfaces can only be used in the respective mode and if the [Port Configuration](#) is set accordingly.
- For the current R&S ZNL14 and R&S ZNL20 models (order nos.1323.0012.14 and 1323.0012.20), the [spectrum analysis option](#) is **not available** and hence the "Spectrum Mode" functions cannot be used at all.

9.7.10 GPIB Interface

Option R&S FPL1-B10

This user-retrofitable plugin-unit provides a GPIB bus connector according to standard IEEE 488 / IEC 625. The GPIB bus interface is primarily intended for remote control of the R&S ZNL/ZNLE from a controller. For details, refer to [Chapter 15.3.2, "GPIB Interface"](#), on page 1016.

9.7.11 Broadband Limiter

R&S ZN-B13

If not properly discharged, even a passive DUT can build thousands of volts of static electricity between its armor and inner conductor. If you are working in an environment where electrostatic discharges are possible, or if you are not discharging your DUT before measuring it, make sure that the instrument is properly grounded. You can use any screw on the VNA chassis to connect it to the ground.

For additional protection, Rohde & Schwarz recommends using broadband limiters R&S ZN-B13 (stock number 1303.7840.02) at each port of your R&S ZNL/ZNLE3|4|6.

9.7.12 DC Power Supply 12/24 V

R&S FPL1-B30

A R&S ZNL that is equipped with this user-retrofitable plugin-unit can be connected to DC power supplies from +12 V to +24 V and from 13 A to 6.5 A.



This option is not available for the R&S ZNLE.

9.7.13 Internal Li-Ion Batteries

R&S FPL1-B31

With the Li-ion battery pack (option R&S FPL1-B31), the R&S ZNL can be operated independently of an AC or DC power supply. The instrument can house 2 Li-ion batteries which can be charged both via AC or DC power supply.



This option is not available for the R&S ZNLE. For the R&S ZNL, it can be retrofitted by Rohde&Schwarz service.

10 VNA GUI Reference

This chapter describes the Graphical User Interface (GUI) of the VNA mode of the R&S ZNL/ZNLE. For the R&S ZNLE, only this mode is available.

The most convenient way to access the GUI functions is via [Softtools](#). Hence the GUI reference is structured accordingly.

The softtools, in turn, can be opened via the keys on the (virtual) front panel of the instrument. For details, see [Chapter 10.1, "Function Keys and Softtools"](#), on page 294.

In case a GUI function can also be performed via remote control, one or more links at the end of the function description point to the related remote control commands.



For a general overview of the analyzer's capabilities and their use, refer to [Chapter 9, "VNA Concepts and Features"](#), on page 186.

10.1 Function Keys and Softtools

Most of the [Function Keys](#) serve as "openers" for an associated softtool in the analyzer GUI.

By default, the following "opener logic" is applied:

- If the associated softtool is not displayed, pressing the hardkey
 - opens the associated softtool
 - activates its first enabled tab (default) or the last used tab (see ["Use Default Tab for Hardkey"](#) on page 144)
 - activates the first enabled input control on this tab (if any)
- If the associated softtool is already displayed, pressing the hardkey
 - activates the next enabled tab on the associated softtool (cyclically)
 - activates the first enabled input control on this tab (if any)

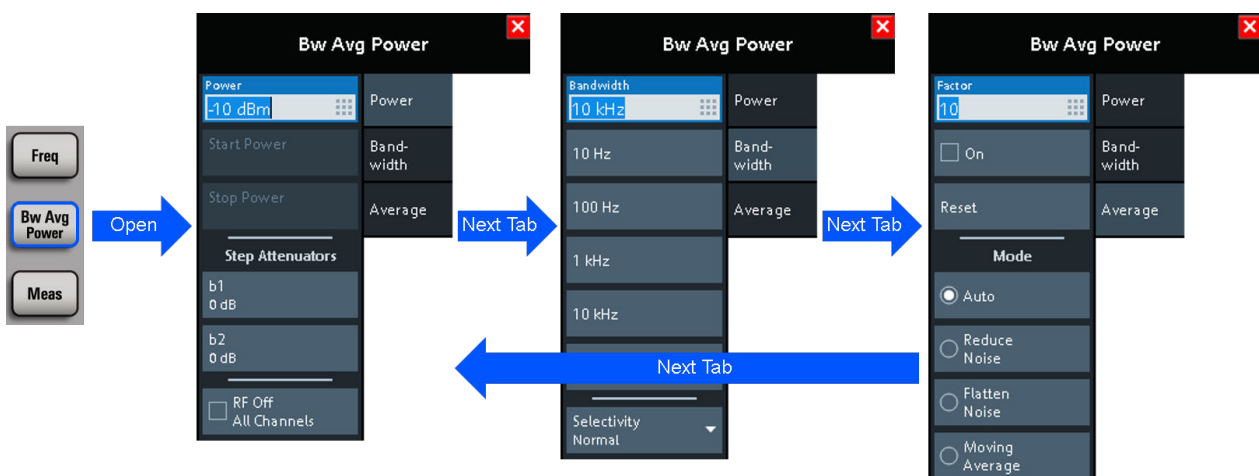

Table 10-1: Function keys and softtools

Key	Keyboard Shortcut	Related Soft-tool	Action
[Freq]	Alt + Shift + J	Stimulus Soft-tool	Selects an input field corresponding to the frequency or span of the active channel's current sweep type. Activates the corresponding tab on the "Stimulus" softtool.
[Span]	Alt + Shift + K		
[Scale]	Alt + Shift + C	Scale Softtool	Default
[Bw Avg Power]	Alt + Shift + L	Bw Avg Power Softtool	Default
[Sweep]	Alt + Shift + M	Sweep Softtool	Default
[Trace]	Alt + Shift + F	Trace Softtool	Default
[Trig]	Alt + Shift + S	Sweep Softtool	Activates the first active input field on the "Trigger" tab
[Meas]	Alt + Shift + A	Meas Softtool	Default
[Format]	Alt + Shift + W	Format Softtool	Default
[Display Lines]	Alt + Shift + B	Display Lines Softtool	Default
[Mkr]	Alt + Shift + G	Marker Settings Softtool	Default
[Mkr->]	Alt + Shift + H	Marker Search Softtool	Default
[Cal]	Alt + Shift + D	Cal Softtool	Default
[Channel]	Alt + Shift + E	Channel Soft-tool	Default
[Offset Embed]	Alt + Shift + R	Offset Embed Softtool	Default

10.2 Stimulus Softtool

On the "Stimulus" softtool, you can access to the stimulus parameters of the active channel. If the active trace is represented in [Time Domain](#), it also allows you to configure the "observation interval".

Access: [Freq] or [Span] hardkey



- While in Cartesian diagrams the x-axis represents the stimulus values, in polar and Smith diagrams this direct relation is lost. In any case, a marker can be used to display the stimulus value of a given trace point.
For "Time Domain" traces, points in the "observation interval" are interpreted as stimulus values.
- All stimulus settings except the "Time Domain X-Axis" settings are channel settings. "Time Domain X-Axis" applies to the active (time domain) trace only.



Background information

Refer to [Chapter 9.1.3, "Traces, Channels and Diagrams"](#), on page 187.

10.2.1 Stimulus Tab

Defines the sweep range in the current channel, depending on the sweep type.



Related Settings

Refer to the following sections:

- [Chapter 9.1.4.2, "Stimulus and Sweep Types"](#), on page 191
- [Chapter 10.5.2, "Sweep Type Tab"](#), on page 312

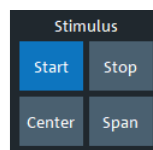
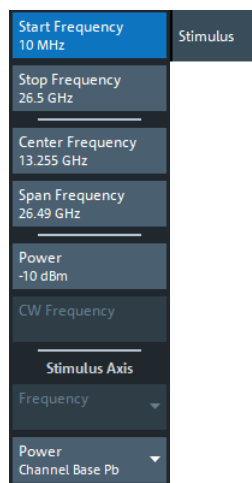

The [Power](#) setting is also available on the "Power" tab.

Start Frequency / Stop Frequency / Center Frequency / Span Frequency

Defines the sweep range for non-segmented frequency sweeps.

For a [Lin Freq](#) sweep, setting "Start Frequency" and "Stop Frequency" or "Center Frequency" and "Span Frequency" are alternatives.

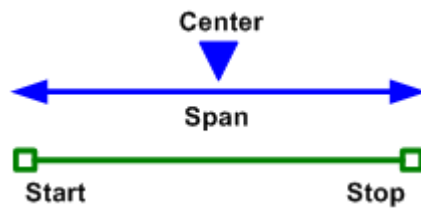

For a [Log Freq](#) only "Start Frequency" and "Stop Frequency" can be set.

Note: For segmented frequency sweeps the start and stop frequencies and the number of sweep points are defined per segment. See [Chapter 10.5.2.2, "Define Segments Dialog"](#), on page 317.

Remote command:

```
[SENSe<Ch>:] FREQuency: START
```

```
[SENSe<Ch>:] FREQuency: STOP
```

```
[SENSe<Ch>:] FREQuency: CENTer
```

```
[SENSe<Ch>:] FREQuency: SPAN
```

```
SYSTem: FREQuency? (query frequency range of the network analyzer)
```

Number of Points

Sets the total number of measurement points for [CW Mode](#) sweeps.

This value can also be set on the "Sweep Params" tab of the "Sweep" softtool (see ["Number of Points"](#) on page 310).

Remote command:

```
[SENSe<Ch>:] SWEep: POINTs
```

CW Frequency

Sets the fixed frequency for [CW Mode](#) and [Time](#) sweeps.

Remote command:

```
[SENSe<Ch>:] FREQuency: FIXed
```

```
[SENSe<Ch>:] FREQuency [ : CW]
```

```
SOURce<Ch>: FREQuency<PhyPt>: FIXed
```

```
SOURce<Ch>: FREQuency<PhyPt> [ : CW]
```

10.2.2 Power Tab

The "Power" tab provides settings related to transmit and receive power. It is also displayed on the "Bw Avg Power" softtool.

10.2.2.1 Controls on the Power Tab

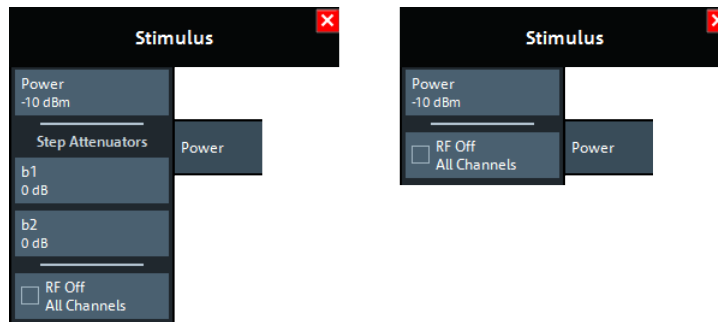

left = R&S ZNL with [Receiver Step Attenuators](#)

right = R&S ZNLE (or R&S ZNL without receiver step attenuators)

Power

Determines the output power at the test ports. Also determines the default output power for "Segmented" sweeps, where the output power can be set per segment.

Remote command:

```
SOURce<Ch>:POWer<PhyPt>[:LEVel][:IMMediate][:AMPLitude]
```

Step Attenuators

Defines an attenuation factor for the received waves at each analyzer port. At least one receiver step attenuator must be installed to use this feature; see [Chapter 9.7.6, "Receiver Step Attenuators"](#), on page 291.

Receiver step attenuators are used to adapt the received signal level to the input level range of the analyzer. They protect the instrument from being overloaded or damaged, e.g. if the DUT is a power amplifier.

Attenuation factors are port- and channel-specific. Possible values are 0 dB to 30 dB in steps of 10 dB. The analyzer rounds any entered value below the maximum attenuation to the closest step.

Note: Receiver step attenuators are optional hardware (see [Chapter 9.7.6, "Receiver Step Attenuators"](#), on page 291).

For the R&S ZNLE receiver step attenuators are not available and hence the "Step Attenuators" section is always hidden.

Remote command:

```
[SENSe<Ch>:]POWer:ATTenuation
```

RF Off All Channels

"RF Off All Channels" switches the internal power source for all channels off (if checked) or on. Switching off the RF power helps to prevent overheating of a connected DUT while no measurement results are taken.

Remote command:

```
OUTPut<Ch>[:STATe]
```

10.2.3 Time Domain X-Axis Tab

If the active trace is a time domain trace, these settings define its stimulus axis.



- Time domain analysis requires option R&S ZNL-K2. If this option is not installed, the "Time Domain X-Axis" tab is hidden.
- Since firmware version 1.30, this option is also available for the R&S ZNLE.



Related information

Refer to the following sections:

- [Chapter 9.7.1, "Time Domain Analysis"](#), on page 282
- [Chapter 10.6.5, "Time Domain Tab"](#), on page 344

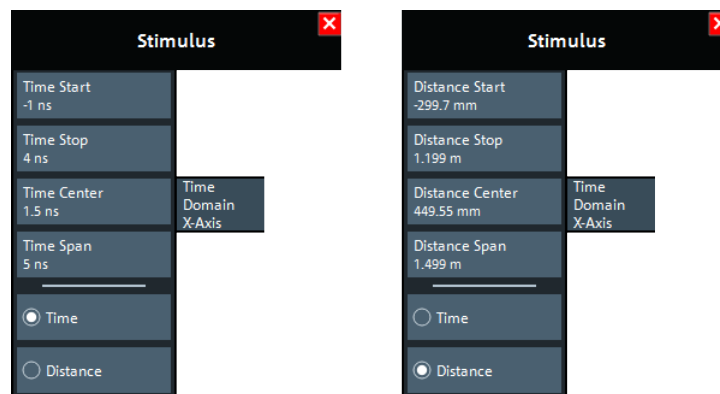

Figure 10-1: Stimulus > Time Domain X-Axis softtool tab

left = Time representation
right = Distance representation

Time Start / Time Stop / Time Center / Time Span

Defines the display range for the time domain trace in time representation (see "[Time / Distance](#)" on page 300).

- "Time Start" is the lowest displayed time and corresponds to the left edge of the Cartesian diagram.
- "Time Stop" is the highest displayed time and corresponds to the right edge of the Cartesian diagram.
- "Time Center" corresponds to the center of the Cartesian diagram, i.e. $(\text{"Time Start"} + \text{"Time Stop"})/2$.
- "Time Span" corresponds to the diagram width, i.e. $(\text{"Time Stop"} - \text{"Time Start"})$.

"Time Start" and "Time Stop" or "Time Center" and "Time Span" are alternative settings.

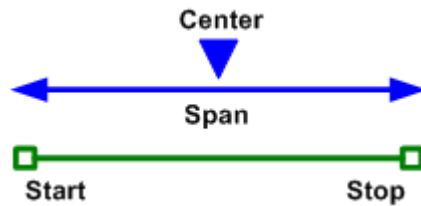

Remote command:

```
CALCulate<Chn>:TRANSform:TIME:START
```

```
CALCulate<Chn>:TRANSform:TIME:STOP
```

```
CALCulate<Chn>:TRANSform:TIME:CENTER
```

```
CALCulate<Chn>:TRANSform:TIME:SPAN
```

Distance Start / Distance Stop / Distance Center / Distance Span

Defines the display range for the time domain trace in distance representation (see "[Time / Distance](#)" on page 300).

"Distance Start" and "Distance Stop" or "Distance Center" and "Distance Span" are alternative settings.

Remote command:

n.a.

See "[Time Start / Time Stop / Time Center / Time Span](#)" on page 299.

Time / Distance

"Time" and "Distance" switch over between the x-axis scaling in time units or distance units.

The interpretation of time and distance depends on the measurement type. For reflection measurements (S-parameters S_{ii} or ratios with equal port indices), the time axis represents the propagation time of a signal from the source to the DUT and back. For transmission measurement, it represents the propagation time from the source through the device to the receiver.

The distance between the source and the DUT is calculated from the propagation time, the velocity of light in the vacuum, and the velocity factor of the receiving port:

- $Distance = \langle Time \rangle * c_0 * \langle Velocity Factor \rangle$ for transmission measurements
- $Distance = 1/2 * \langle Time \rangle * c_0 * \langle Velocity Factor \rangle$ for reflection measurements. The factor 1/2 accounts for the return trip from the DUT to the receiver.

The velocity factor of the receiving port can be defined using [Offset Embed] > "Offset" (see "[Permittivity / Velocity Factor](#)" on page 501).

Remote command:

```
CALCulate<Chn>:TRANSform:TIME:XAXis
```

10.3 Scale Softtool

The "Scale" softtool allows you to define how the active trace is displayed in its current format.

Access: [Scale] hardkey

10.3.1 Scale Values Tab

Provides the functions for diagram scaling.



The "Scale Values" settings are closely related to the "Format" and "Display" settings.

The "Scale Values" settings depend on the current trace format (diagram type) because not all diagrams can be scaled in the same way:

- In Cartesian diagrams, all scale settings are available.
- In circular diagrams, no "Scale/Div", no "Ref Pos", and no "Max" and "Min" values can be defined.

The default scale is activated automatically when a display format (diagram type) is selected. Scale settings that are not compatible with the current display format are unavailable (grayed out).

Relations between the scaling parameters

The scaling parameters "Scale/Div", "Ref Value", "Ref Pos", "Max", and "Min" are coupled together in the following manner:

- "Max" – "Min" = "Scale/Div" · <Number of graticule divisions>
- "Max" = "Ref Value" when "Ref Value" is 10
- "Min" = "Ref Value" when "Ref Value" is 0



Alternatives to Scaling

There are several alternatives to manual trace/diagram scaling. Refer to the following sections:

- [Chapter 4.3.2, "Zooming into the Display"](#), on page 59
- [Chapter 4.4.4, "Touchscreen Gestures"](#), on page 81 (zoom stimulus via spreading and pinching)
- [Chapter 10.2.1, "Stimulus Tab"](#), on page 296

Auto Scale Trace

Adjusts the "Scale/Div" and the "Ref Value" to display the entire active trace in the diagram area, leaving an appropriate display margin.

- In Cartesian diagrams, the analyzer recalculates the values of the vertical divisions so that the trace fits onto approx. 80% of the vertical grid. The reference value is chosen to center the trace in the diagram.
- In circular diagrams ("Polar", "Smith", "Inv Smith"), the analyzer recalculates the values of the radial divisions so that the diagram is confined to approx. 80% of the outer circumference. The reference value is set to the value of the outer circumference.

Auto scale does not affect the stimulus values and the horizontal axis.

Remote command:

```
DISPlay[:WINDow<Wnd>]:TRACe<WndTr>:Y[:SCALe]:AUTO
```

Auto Scale Diagram

Adjusts the "Scale/Div" and the "Ref Value" to display all traces in the diagram area, leaving an appropriate display margin. All traces in the active diagram are scaled independently (see ["Auto Scale Trace"](#) on page 302), and irrespective of their channel assignment.

Auto Scale Diag. (Common Scale)

Similar to ["Auto Scale Diagram"](#) on page 302, but scales equally formatted traces together.

Ref Value = Marker

See ["Ref Val = Marker / Max = Marker / Min = Marker"](#) on page 435.

Scale/Div

Sets the value of the vertical diagram divisions in Cartesian diagrams.

"Scale/Div" corresponds to the increment between two consecutive grid lines. The unit depends on the display format: dB for display format "dB Mag", degrees for "Phase" and "Unwr Phase", ns for "Delay", U (units) for all other (dimensionless) formats.

"Scale/Div" is not available for circular diagrams ("Polar", "Smith", "Inv Smith").

Remote command:

```
DISPlay[:WINDow<Wnd>]:TRACe<WndTr>:Y[:SCALe]:PDIVision
```

Ref Value

Sets the reference line of a Cartesian diagram or the outer circumference of a circular diagram.

- In Cartesian diagrams "Ref Value" defines the value of the reference line, indicated by an arrowhead symbol at the right edge of the diagram area. The color of the symbol corresponds to the trace color. As the "Ref Value" is varied, the position of the reference line ("Ref Pos") is left unchanged, so that the current trace is shifted in vertical direction. The unit of the "Ref Value" depends on the display format: dB for display format "dB Mag", degrees for "Phase" and "Unwr Phase", ns for "Delay", U (units) for all other (dimensionless) formats.
- In circular diagrams ("Polar", "Smith", "Inv Smith"), "Ref Value" defines the value of the outer circumference. Changing "Ref Value" enlarges or scales down the diagram, leaving the center unchanged. The unit is U (units) for all circular diagrams.

Remote command:

```
DISPlay[:WINDow<Wnd>]:TRACe<WndTr>:Y[:SCALe]:RLEVel
```

Ref Pos

Defines the position of the reference line in a Cartesian diagram.

The reference line is indicated by an arrowhead symbol at the right edge of the diagram area. The color of the symbol corresponds to the trace color. "Ref Pos" is defined on a linear scale between 0 (bottom line of the diagram) and 10 (top line of the diagram). As the "Ref Pos" is varied, the value of the reference line ("Ref Value") is left unchanged, so the current trace is shifted together with the "Ref Pos".

"Ref Pos" is not available (grayed) for polar diagrams ("Polar", "Smith", "Inv Smith").

Remote command:

```
DISPlay[:WINDow<Wnd>]:TRACe<WndTr>:Y[:SCALe]:RPOSition
```

Max / Min

Define the upper and lower edge of a Cartesian diagram.

"Max" and "Min" are not available (grayed) for polar diagrams ("Polar", "Smith", "Inv Smith").

Remote command:

```
DISPlay[:WINDow<Wnd>]:TRACe<WndTr>:Y[:SCALe]:TOP
DISPlay[:WINDow<Wnd>]:TRACe<WndTr>:Y[:SCALe]:BOTTom
```

Continuous Auto Scale Trace

Similar to [Auto Scale Trace](#), but applies auto-scaling continuously, even during a running sweep.

Remote command:

n.a.

10.3.2 Scale Coupling Tab

Selects common scale settings for all traces. The softkeys are available if the active channel setup contains at least two traces, and if the active trace is not a reference trace ("To Trace").



Related settings

Refer to [Chapter 10.6.1.2, "Trace Manager Dialog"](#), on page 333.

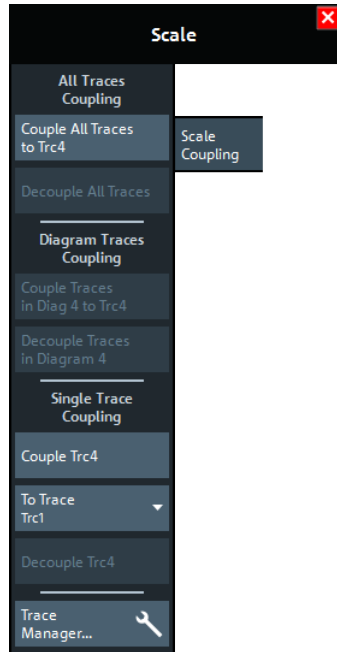

The "Trace Manager..." button opens the [Trace Manager Dialog](#).

Couple All Traces / Couple Trc ... To Trace

Applies the scale settings of the reference trace ("To Trace") to all traces / to the active trace.

Remote command:

n/a

Decouple All Traces / Decouple Trc

Assigns independent scale settings to all traces / to the active trace.

Remote command:

n/a

10.3.3 Zoom Tab

Provides graphical and stimulus zoom functions for cartesian diagrams.

The graphical zoom magnifies a (paraxial) rectangular portion of a diagram without modifying any sweep parameters. The stimulus zoom also magnifies the selected rectangle, but at the same time narrows the sweep range of the active channel to the rectangle's horizontal range.



Alternatives to Zooming

There are several alternatives to graphical/numerical zooming. Refer to the following sections:

- [Chapter 4.3.2, "Zooming into the Display"](#), on page 59
- [Chapter 10.3.1, "Scale Values Tab"](#), on page 301
- [Chapter 4.4.4, "Touchscreen Gestures"](#), on page 81 (zoom stimulus via spreading and pinching)
- [Chapter 10.2.1, "Stimulus Tab"](#), on page 296

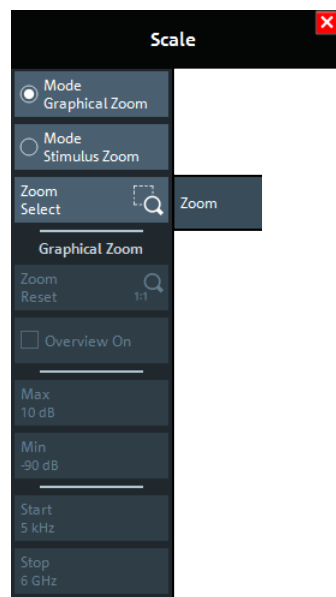

Mode Graphical Zoom/Mode Stimulus Zoom

Switches between graphical and stimulus zoom mode.

Use the [zoom selection button](#) to initiate the selection of a (paraxial) rectangular zoom area. Its label changes according to the selected zoom mode.

Remote command:

n.a.

Zoom Select/Stim. Zoom Select

Prepares the analyzer GUI for the selection of a (paraxial) rectangular zoom area.

The effect of the subsequent selection depends on the current [zoom mode](#) (as indicated on the button label):

- In "Mode Graphical Zoom" (button label "Zoom Select"), the selected rectangle is magnified without modifying any sweep parameters.
- In "Mode Stimulus Zoom" (button label "Stim. Zoom Select") the selected rectangle is magnified as well, but at the same time the sweep range of the active channel is narrowed to the rectangle's horizontal range.

You can define the zoom area using touchscreen or mouse. To modify the zoom window in graphical zoom mode, you can also use the numerical input fields "Max", "Min", "Start", and "Stop".

Remote command:

```
DISPlay[:WINDow<Wnd>]:TRACe<WndTr>:ZOOM[:STATe]
```

Zoom Reset

If a [graphical zoom](#) has been applied to the current diagram, this action resets the zoom area.

Remote command:

```
DISPlay[:WINDow<Wnd>]:TRACe<WndTr>:ZOOM[:STATe]
```

Overview On

If a [graphical zoom](#) has been applied to the active diagram (and has not been [reset](#), this button toggles the overview for this diagram.

The overview appears in the upper part of the diagram and shows the original diagram and the zoom area. You can move the zoomed part of the trace by moving the zoom area or use the numerical input fields "Max", "Min", "Start", "Stop" to do so.

Remote command:

```
DISPlay[:WINDow<Wnd>]:TRACe<WndTr>:ZOOM[:STATe]
```

Max / Min / Start / Stop

Defines the coordinates of the graphical zoom window for the active diagram. "Max" and "Min" define the response axis range, "Start" and "Stop" define the stimulus axis range.

The input fields are only enabled if a zoom area was selected before.

Remote command:

```
DISPlay[:WINDow<Wnd>]:TRACe<WndTr>:ZOOM:BOTTom
```

```
DISPlay[:WINDow<Wnd>]:TRACe<WndTr>:ZOOM:START
```

```
DISPlay[:WINDow<Wnd>]:TRACe<WndTr>:ZOOM:STOP
```

```
DISPlay[:WINDow<Wnd>]:TRACe<WndTr>:ZOOM:TOP
```

10.4 Bw Avg Power Softtool

The "Bw Avg Power" softtool allows you to configure the signal power, to set up the IF signal processing, and to configure the averaging logic.

Access: [Bw Avg Power] hardkey

10.4.1 Power Tab

The "Power" tab allows you to configure the signal power. It is identical to the "Stimulus" > "Power" tab; see [Chapter 10.2.2, "Power Tab"](#), on page 297.

10.4.2 Bandwidth Tab

Sets the measurement bandwidth and the shape of the digital IF filter (R&S ZNL only) for the active channel.

A system error correction (calibration) remains valid when the filter settings are changed.



Segmented sweeps

In segmented frequency sweeps, the filter settings can be selected independently for each segment. see [Chapter 10.5.2.2, "Define Segments Dialog"](#), on page 317.

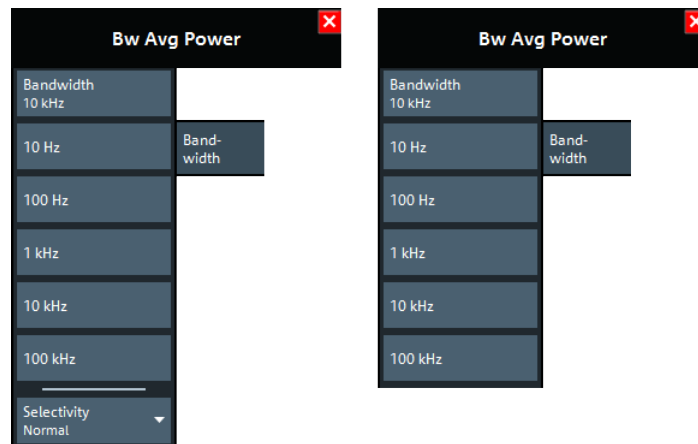

left = R&S ZNL
right = R&S ZNLE

Bandwidth

"Bandwidth" the measurement bandwidth of the IF filter. Within the value range, the entered value is rounded up to $1 \cdot 10^n$ Hz, $1.5 \cdot 10^n$ Hz, $2 \cdot 10^n$ Hz, $3 \cdot 10^n$ Hz, $5 \cdot 10^n$ Hz, $7 \cdot 10^n$ Hz ($n \geq 0$). Values exceeding the maximum bandwidth are rounded down.

The bandwidth range is 1 Hz to 500 kHz.

Remote command:

```
[SENSe<Ch>:]BANDwidth[:RESolution]
```

```
[SENSe<Ch>:]BWIDth[:RESolution]
```

Selectivity

Selects the shape of the IF filter:

- Filters with "Normal" selectivity provide the shortest settling time (recommended for fast measurements).
- "Medium" selectivity filters have steeper edges but require longer settling times.
- "High" selectivity filters have the steepest edges and the longest settling times. This filter type is suitable for isolating adjacent signals which are separated by a small frequency spacing.

Note: For the R&S ZNLE always "Normal" selectivity filters are used and hence this setting is hidden.

Remote command:

```
[SENSe<Ch>:]BANDwidth[:RESolution]:SElect
[SENSe<Ch>:]BWIDth[:RESolution]:SElect
```

10.4.3 Average Tab

Defines the number of consecutive sweeps to be averaged and enables/disables the sweep average.



Effects of sweep averaging, alternative settings

An average over several sweeps reduces the influence of random effects in the measurement and therefore minimizes the noise level. The effect increases with the average factor, however, obtaining an averaged result requires several sweeps and therefore increases the measurement time.

Smoothing is an alternative method of compensating for random effects on the trace by averaging adjacent measurement points. Compared to the sweep average, smoothing does not significantly increase the measurement time but can eliminate narrow peaks and thus produce misleading results.

The sweep average is not frequency selective. To eliminate a spurious signal near the measurement frequency, alternative techniques (e.g. a smaller filter bandwidth) must be used.



The average factor is also valid for calibration sweeps. The calculation of system correction data is based on the averaged trace.

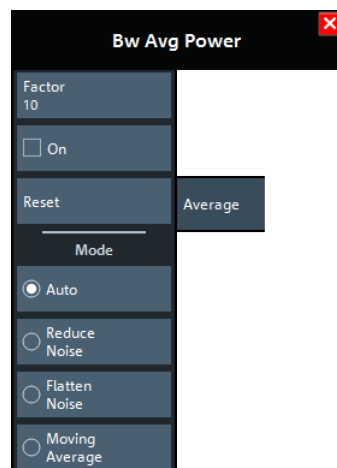

Factor / On / Reset

"Factor" defines the number of averaged traces, "On" enables or disables the sweep average, "Reset" starts a new average cycle. The average cycle is also restarted when the [averaging mode](#) is changed.

Remote command:

```
[SENSe<Ch>:] AVERage: COUNT
[SENSe<Ch>:] AVERage [: STATe]
[SENSe<Ch>:] AVERage: CLEAr
```

Mode

Selects one of the following averaging algorithms:

- **"Auto"**: Automatic selection between **"Reduce Noise"** and **"Flatten Noise"** mode, depending on the trace type.
- **"Reduce Noise"**: Cumulative moving averages of the real and imaginary parts of each measurement result, provides the most effective noise suppression for the "Real" and "Imag" formats and for polar diagrams.
- **"Flatten Noise"**: Cumulative moving averages of the (linear) magnitude and phase values, provides the most effective noise suppression for the "dB Mag", "Phase", "Unwr. Phase", and "Lin Mag" formats.
- **"Moving Average"**: Simple moving averages of the real and imaginary parts of each measurement result; similar to "Reduce Noise", but with finite history.

Changing the mode resets the average cycle.

Remote command:

```
[SENSe<Ch>:] AVERage: MODE
```

10.5 Sweep Softtool

The "Sweep" softtool allows you to define the scope of the measurement in the active channel.

The available settings comprise the sweep type (with related parameters), the trigger conditions, and the periodicity of the measurement.

Access: [Sweep] hardkey



Background information

Refer to the following sections:

- [Chapter 9.1.4, "Sweep Control"](#), on page 189
- [Chapter 9.1.4.2, "Stimulus and Sweep Types"](#), on page 191

10.5.1 Sweep Params Tab

Allows you to define the scope and timing of the measurement in the active channel.



Segmented sweeps

In "Segmented" linear frequency sweeps, the sweep parameters can be set independently for each segment. See [Chapter 10.5.2.2, "Define Segments Dialog"](#), on page 317.



System error correction

In general, the system error correction is no longer valid after a change of the sweep parameters. The status of the calibration is shown in the trace list. If the number of points is changed, the analyzer interpolates the correction data. The calibration label "Cal Int" is displayed. See also [Chapter 9.5.4, "Calibration Labels"](#), on page 260.

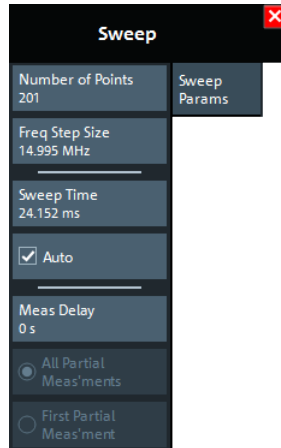

Number of Points

Sets the total number of measurement points per sweep. The minimum number of points is 1 (measurement at a single frequency/power/time value). The maximum depends on the analyzer type.

Sets the total number of measurement points per sweep. The minimum number of points is 1 (measurement at a single frequency/power/time value), the maximum is 100,001.

Together with the sweep range defined in the [Stimulus Tab](#) of the "Stimulus" softtool, this parameter defines the grid of sweep points. The step width between two consecutive sweep points is constant on a linear scale (sweep types "Lin Freq", "Time" and "CW Mode") or on a logarithmic scale (sweep types "Log Freq" and "Power").

The sweep points for linear frequency sweeps can also be defined using the [Freq Step Size](#).

Tip: Measurement time and screen resolution

Increasing the number of sweep points improves the resolution of the trace but increases the measurement time. The overall measurement time is composed of the hardware settling time at the beginning of the sweep plus the sum of the measurement times at each individual sweep point. Hence the measurement time increases roughly linearly with the number of points.

See also [Chapter 9.1.4, "Sweep Control"](#), on page 189.

Remote command:

```
[SENSe<Ch>:] SWEep: POINTs
```

Freq Step Size

Sets the distance between two consecutive sweep points of a linear frequency sweep.

For linear frequency sweeps the step size is an alternative to the [Number of Points](#) setting:

- If the sweep range is defined via "Start Frequency" and "Stop Frequency", both the "Stop Frequency" value and the "Number of Points" can vary as the "Freq Step Size" is changed. The "Stop Frequency" value is changed as little as possible so that the condition
$$\text{"Freq Step Size"} = (\text{"Stop Frequency"} - \text{"Start Frequency"}) / (\text{"Number of Points"} - 1)$$
 can be fulfilled. Changing the "Start Frequency" and "Stop Frequency" modifies the "Freq Step Size".
- If the sweep range is defined via "Center Frequency" and "Span Frequency", both the "Span Frequency" value and the "Number of Points" can vary as the "Freq Step Size" is changed. The "Span Frequency" is reduced as little as possible so that the condition
$$\text{"Freq Step Size"} = \text{"Span Frequency"} / (\text{"Number of Points"} - 1)$$
 can be fulfilled. Changing the "Span Frequency" modifies the "Freq Step Size".

Note:

- This setting is valid for linear frequency sweeps only. It does not apply to logarithmic and segmented sweeps, time or CW mode sweeps.
- Decreasing the "Freq Step Size" generally increases the measurement time.

Remote command:

```
[SENSe<Ch>:] SWEep:STEP
```

Sweep Time / Auto

Varies the measurement time for a sweep or delays the start of each sweep.

- "Sweep Time" is the total measurement time for the sweep. The minimum possible sweep time is equal to the estimated value in "Auto" mode. Setting a larger sweep time is equivalent to defining a [Meas Delay](#) before each partial measurement.
- "Auto" minimizes the sweep time. The [Meas Delay](#) is set to 0 s. "Sweep Time" indicates the estimated sweep time, depending on the current measurement settings. The "Sweep Time" and "Meas Delay" values are maintained until changed explicitly if "Auto" is switched off.

If a time sweep is active, "Sweep Time" cannot be modified. The analyzer uses the previously defined sweep time settings.

Remote command:

```
[SENSe<Ch>:] SWEep:TIME
```

```
[SENSe<Ch>:] SWEep:TIME:AUTO
```

Meas Delay

Adds a delay time before the start of every partial measurement. See [Chapter 9.1.4.1, "Partial Measurements and Driving Mode"](#), on page 190 .

"Meas Delay" is not available while a "Time" or "CW Mode" sweep is active.

As an alternative to increasing the delay (and thus the total sweep time), it is possible to select "Alternated" driving mode; see ["Driving Mode"](#) on page 487.

Remote command:

```
[SENSe<Ch>:] SWEep:DWELL
```

All Partial Meas'ments / First Partial Meas'ment

If [Meas Delay](#) is set to a value > 0, this setting allows you to define how the measurement delay is applied:

- If "All Partial Meas'ments" is selected, the delay time is added before each partial measurement. For a complete 2 port S-parameter measurement, the delay must be added twice per sweep point.
- If "First Partial Meas'ment" is selected, the delay time is added once per sweep point only, irrespective of the measured quantities and the number of partial measurements. The sweep time increases by the measurement delay times the number of sweep points.

Tip: A delay time before the start of each partial measurement increases the accuracy, in particular for measurements on DUTs with long settling times (e.g. quartz oscillators, SAW filters). Select "First Partial Meas'ment" if the DUT does not require an additional settling time due to the interchange of source and receive ports.

Remote command:

```
[SENSe<Ch>:]SWEep:DWELl:IPoint
```

10.5.2 Sweep Type Tab

Defines the sweep variable (frequency/time) and the position of the sweep points across the sweep range.

10.5.2.1 Controls on the Sweep Type Tab

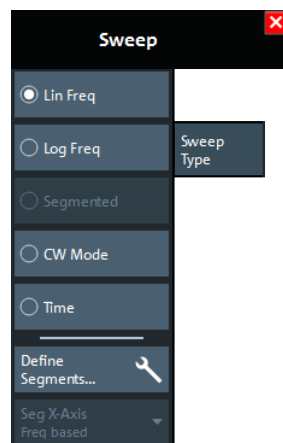

Lin Freq

In a linear frequency sweep, the stimulus frequency is swept in equidistant steps over the continuous frequency range. The frequency range (sweep range) and the internal generator power can be specified in the "Stimulus" settings (see [Chapter 10.2.1, "Stimulus Tab"](#), on page 296). The step width between two consecutive sweep points is constant and given by $\frac{\text{Span}}{(n - 1)}$ where n is the specified "Number of Points" ($n > 1$).

"Lin Freq" is the default sweep type. In a Cartesian diagram, the measurement result is displayed as a trace over a linear frequency scale (as known, e.g., from spectrum analyzers). The following example shows a "Lin Freq" sweep with the forward transmission parameter S_{21} as measured quantity, and a "dB Mag" scaled y-axis.

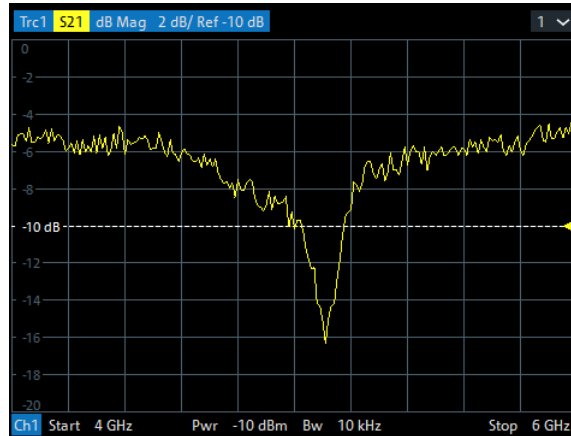

Remote command:

```
[SENSe<Ch>:] SWEep:TYPE LINear
```

Log Freq

In a "Log Freq" sweep, the stimulus frequency is swept on a logarithmic scale over the continuous frequency range. The frequency range (sweep range) and the internal generator power can be specified in the "Stimulus" settings (see [Chapter 10.2.1, "Stimulus Tab"](#), on page 296). The sweep points are calculated from the "Span" and the specified "Number of Points" ($n > 1$) with the condition that the step width is constant on the logarithmic scale.

"Log Freq" sweeps are suitable for the analysis of a DUT over a large frequency range, e.g. over several octaves. In a Cartesian diagram, the measurement result is displayed as a trace over a logarithmic frequency scale. The following example shows a "Log Freq" sweep with the forward transmission parameter S_{21} as measured quantity, and a "dB Mag" scaled y-axis.

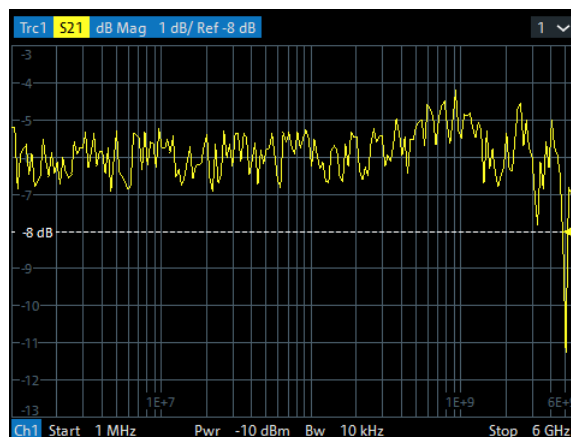

Tip: In "Log Freq" representation, limit lines and ripple limit lines appear as exponential curves; see [Chapter 9.4.1.1, "Rules for Limit Line Definition"](#), on page 232.

Remote command:

```
[SENSe<Ch>:]SWEep:TYPE LOGarithmic
```

Segmented

In a "Segmented" (linear) frequency sweep, the sweep range can be composed of several continuous frequency sub-ranges or single frequency points. The sub-ranges are termed sweep segments and are defined in the [Define Segments Dialog](#).

Sweep segments can overlap. The segment list must contain at least 2 distinct frequency points before a segmented frequency sweep can be started.

Instrument settings such as the internal generator power, the measurement (IF) bandwidth, and the frequency band of the local oscillator can be set independently for the individual segments.

Due to this flexibility, segmented frequency sweeps are suitable for any detailed analysis of a DUT at specified frequencies. In a Cartesian diagram, the measurement result is displayed as a trace over a linear frequency scale ranging from the lowest to the highest frequency point of all segments. The following example shows a segmented frequency sweep with 2 segments. The forward transmission parameter S_{21} is measured, and a "dB Mag" scaled y-axis is used. In the frequency range between the sweep segments, the trace is displayed as a straight line.

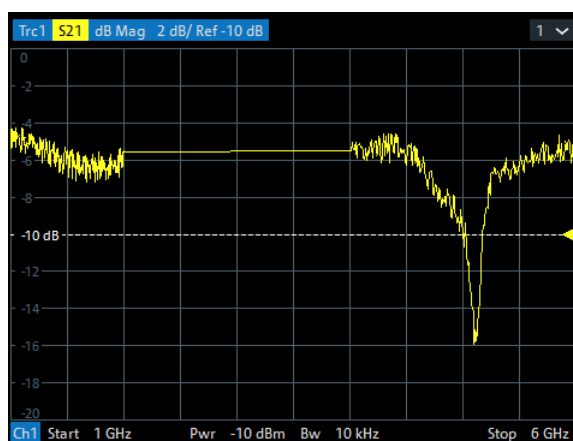

Tip: You can change to point based x-axis to improve the display of a segmented frequency sweep (see ["Seg X-Axis"](#) on page 316).

Remote command:

```
[SENSe<Ch>:]SWEep:TYPE SEGMENT
```

CW Mode

"CW Mode" sweeps, like [Time](#) sweeps, are performed at constant frequency and stimulus power, which can be specified in the "Stimulus" settings (see [Chapter 10.2.1, "Stimulus Tab"](#), on page 296).

The measurement is triggered according to the current trigger settings (see [Chapter 10.5.3, "Trigger Tab"](#), on page 322). Each trigger event triggers the first partial measurement of a measurement point. The time interval between two consecutive measurements depends on the trigger settings and the sweep parameters (especially the number of points). Any trigger mode is allowed.

A "CW Mode" sweep corresponds to the analysis of a signal over the time with a time scale and resolution that is determined by the trigger events. In a Cartesian diagram, the measurement result is displayed as a trace over a linear time scale (like, e.g., in an oscilloscope). The diagram is similar to the "Time" diagram. The following example shows a "CW Mode" sweep with a DUT that does not markedly change its transmission characteristics over the time.

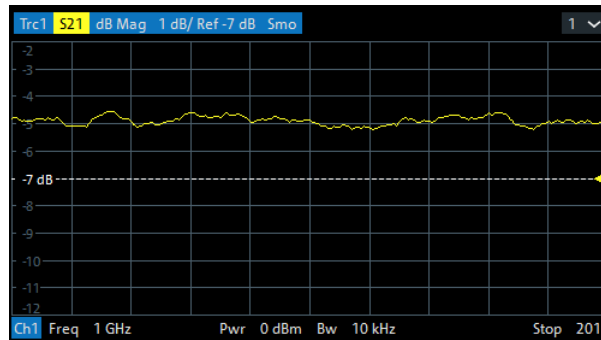

Tip: Sweep time

The time interval between two consecutive trigger pulses must not be smaller than the minimum measurement time per measurement point. See ["Sweep Time / Auto"](#) on page 311.

Remote command:

```
[SENSe<Ch>:]SWEep:TYPE POINTt
```

Time

"Time" sweeps, like [CW Mode](#) sweeps, are performed at constant frequency and stimulus power, which can be specified in the "Stimulus" settings (see [Chapter 10.2.1, "Stimulus Tab"](#), on page 296). A single sweep extends over a specified period of time, defined via the "Stop Time" setting. The time intervals between two consecutive sweep points are calculated according to $\text{"Stop Time"} / (n - 1)$ where n is the selected [Number of Points](#).

A "Time" sweep corresponds to the analysis of a signal over the time; the function of the analyzer is analogous to an oscilloscope. In a Cartesian diagram, the measurement result is displayed as a trace over a linear time scale. The following example shows a "Time" sweep with a DUT that does not markedly change its transmission characteristics over the time.

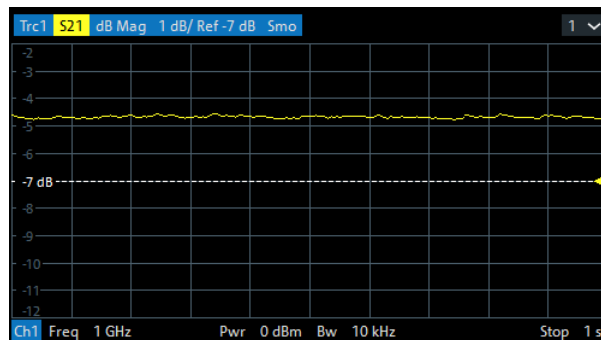

Tip: Sweep time

The minimum sweep time depends on the number of measurement points, the measurement bandwidth, the delay time before each partial measurement and the number of partial measurements required for each measurement point. The analyzer estimates this time, based on the current measurement settings.

If the "Stop Time" is smaller than the estimated minimum sweep time, the entered value is increased automatically.

Equidistance of sweep points

The analyzer tries to keep the time intervals between any two consecutive time sweep points equal: The time sweep samples are equidistant. Equidistance also holds for sweeps which range over several channels.

Remote command:

```
[SENSe<Ch>:] SWEEp:TYPE CW
```

Define Segments...

Opens the [Define Segments Dialog](#) that allows to set up the channel for a [Segmented](#) frequency sweep.

Seg X-Axis

Scales the x-axis for a segmented frequency sweep:

- In "Freq based" mode, the x-axis covers the frequency ranges of all sweep segments, including possible gaps between the segments. Equal frequency spacings correspond to equal distances on the x-axis.
- In "Point based" mode, the x-axis shows all sweep points with equal spacings. Gaps between sweep segments are minimized; no diagram space is "wasted" on unused frequency ranges. Point-based mode is indicated in the channel line.

The example below shows a segmented frequency sweep with two segments. The first segment ranges from 1 GHz to 1.4 GHz; the second segment from 2 GHz to 3 GHz. Both segments contain 11 sweep points. In point-based mode (lower diagram), all sweep points are equidistant.

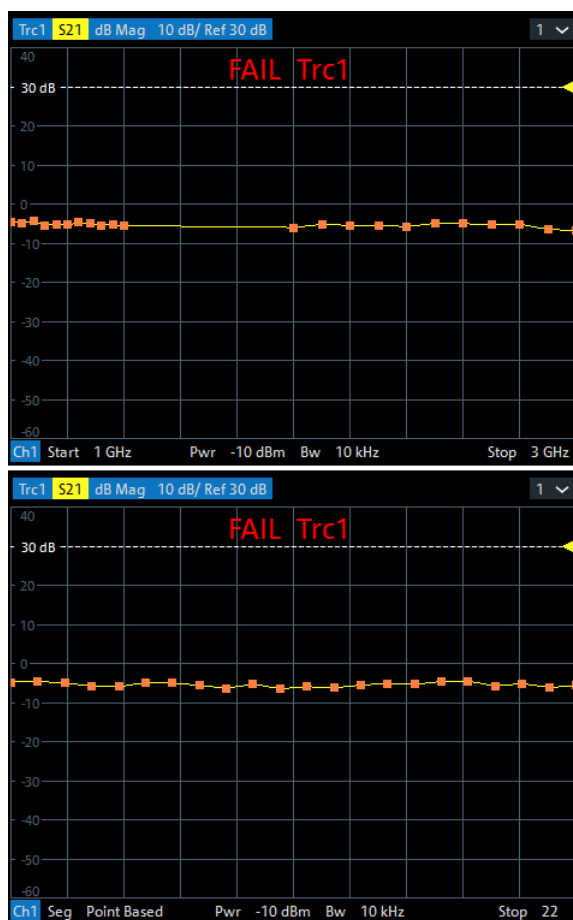

Tip: Overlapping limit line and ripple limit line segments are not displayed when a point-based x-axis is active; see [Chapter 9.4.1.1, "Rules for Limit Line Definition"](#), on page 232.

Remote command:

[SENSe<Ch>:] FREQuency:SEGment:AXIS

10.5.2.2 Define Segments Dialog

The "Define Segments" dialog defines all channel settings for a [Segmented](#) frequency sweep and imports or exports segmented sweep settings.

Access: [Sweep] > "Sweep Type" > "Define Segments..."

The dialog contains a table to edit the individual segments of the sweep range. Use the [Displayed Columns Dialog](#) to select the columns to be displayed and edited.



- Sweep segments are allowed to overlap.
- In contrast to standard frequency sweeps, the start and stop frequency in a sweep segment do not have to be different.
So with a segmented sweep you can measure n_1 points at frequency f_1 (in segment 1), n_2 points at frequency f_2 (in segment 2) etc.

Controls in the Define Segments Dialog

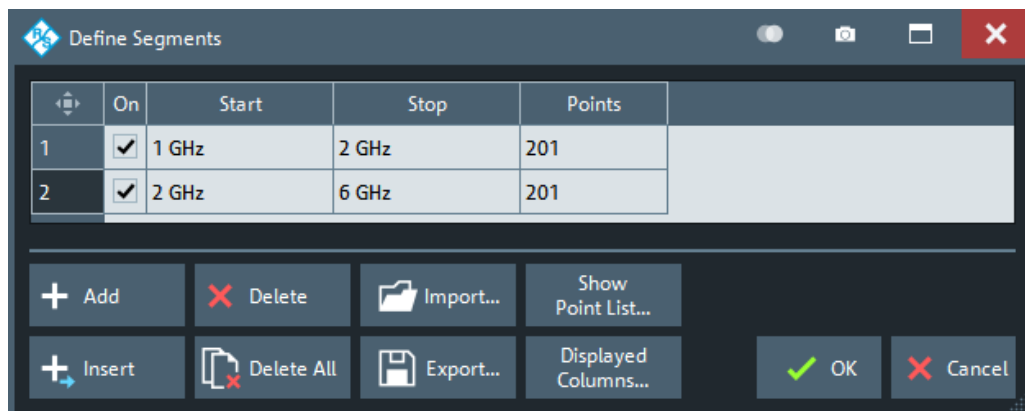

Table Columns

The table in the upper part of the "Define Segments" dialog contains an automatically assigned current number for each segment plus the following editable or non-editable columns:

- "On" provides check boxes to activate or deactivate each individual segment. Sweep points in inactive segments are not measured and not listed in the "Point List".
- "Start" is the stimulus (x-axis) value of the first point of the segment.
- "Stop" is the stimulus (x-axis) value of the last point of the segment.
- "Points" is the number of sweep points in the segment. A single segment can consist of only one point. If "Points" is set to 1, then the "Stop" frequency is set equal to the "Start" frequency.

Note: Displayed Columns and Segment-specific Measurement Settings

The remaining columns allow you to replace channel-wide measurement settings by segment-specific ones. These columns are only displayed – and the corresponding segment-specific values are only applied – if they are selected in the [Displayed Columns Dialog](#).

Note: Limitations for overlapping segments

When overlapping sweep segments are created, the marker functions, trace evaluation functions, trace search functions and band filter functions are still available. It is possible, however, that these tools show an unexpected behavior when used in overlapping sweep segments. The reason is that the assignment of markers to traces in overlapping segments is ambiguous. If you want to analyze a particular segment using markers, turn "Off" all sweep segments that overlap with this segment.

Remote command:

```
[SENSe<Ch>:] SEGMENT:COUNT?
[SENSe<Ch>:] SEGMENT<Seg>[:STATE]
[SENSe<Ch>:] SEGMENT<Seg>:FREQUENCY:START
[SENSe<Ch>:] SEGMENT<Seg>:FREQUENCY:STOP
[SENSe<Ch>:] SEGMENT<Seg>:FREQUENCY:CENTER?
[SENSe<Ch>:] SEGMENT<Seg>:FREQUENCY:SPAN?
[SENSe<Ch>:] SEGMENT<Seg>:SWEeP:POINTs
```

Add / Insert / Delete / Delete All

The four buttons below the segment list extend or shorten the list.

- "Add" adds a new segment to the end of the list.
The added segment covers a possible frequency gap between the preceding segment and the upper frequency limit of the analyzer. The "Start" frequency of the new segment is set equal to the "Stop" frequency of the preceding segment. The "Stop" frequency is equal to the upper frequency limit. The number of points is the same as the number of points of the preceding segment.
- "Insert" inserts a new segment before the active segment. The segment numbers of all segments after the new segment are incremented by one.
The new segment covers a possible frequency gap between the two adjacent segments. A new segment which is inserted before segment no. 1 starts at the lower frequency limit of the analyzer. The number of points is the same as the number of points of the next segment.
- "Delete" removes the selected segment from the list.
- "Delete All" clears the entire segment list so it is possible to define or load a new segmented sweep range.

Remote command:

```
[SENSe<Ch>:] SEGMENT<Seg>:ADD
[SENSe<Ch>:] SEGMENT<Seg>:INSert
[SENSe<Ch>:] SEGMENT<Seg>:DELete[:DUMMy]
[SENSe<Ch>:] SEGMENT<Seg>:DELete:ALL
```

Show Point List...

Opens a list of all active sweep points and their channel settings. All columns except "Point", "Segment" and "Frequency" are displayed only if they are explicitly selected; see "[Displayed Columns Dialog](#)" on page 320.

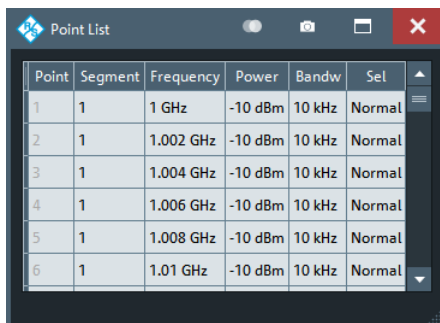

Point	Segment	Frequency	Power	Bandw	Set
1	1	1 GHz	-10 dBm	10 kHz	Normal
2	1	1.002 GHz	-10 dBm	10 kHz	Normal
3	1	1.004 GHz	-10 dBm	10 kHz	Normal
4	1	1.006 GHz	-10 dBm	10 kHz	Normal
5	1	1.008 GHz	-10 dBm	10 kHz	Normal
6	1	1.01 GHz	-10 dBm	10 kHz	Normal

Figure 10-2: Point List

Import.../ Export...

The buttons open standard dialogs to import/export sweep segment settings to/from an ASCII file (*.SegList).

- "Import..." replaces the current segment list by a sweep segment list loaded from a *.SegList file.
- "Export..." stores the current sweep segments settings to a *.SegList file.

Sweep segment files

The analyzer uses a simple ASCII format to export sweep segment data. By default, the sweep segment file extension is *.SegList. The file starts with two comment lines containing the version and a third line reproducing the header of the segment list. The following lines contain the entries of all columns of the segment list, including the "Displayed Columns" that are configured in the "Define Segments" dialog.

Example:

The segmented sweep range

	Name	On	Start	Stop	Points	Pwr (Pb)	Bandw
1	Low	<input checked="" type="checkbox"/>	1 GHz	2 GHz	11	-10 dBm	10 kHz
2	High	<input checked="" type="checkbox"/>	2 GHz	3 GHz	11	-10 dBm	10 kHz

is described by the following sweep segment file:

```
# Version 1.00
#
bo:State,str:Name,Start Frequency[MHz],Stop Frequency[MHz],int:No of Points,Source Power [dBm],IF Bandwidth[Hz]
true,Low,1.0000000000000000E+003,2.0000000000000000E+003,11,-1.0000000000000000E+001,1.0000000000000000E+004,Norma
true,High,2.0000000000000000E+003,3.0000000000000000E+003,11,-1.0000000000000000E+001,1.0000000000000000E+004,Norma
```

Note: The *.SegList file actually contains more columns listing all channel settings of the individual sweep segments. The headings of the additional columns are *IF Bandwidth [Hz]*, *en:IF Selectivity*, *en:IF Sideband*, *Meas Delay [μs]*, *bo:Sweep Time Auto*, *en:Frq Sweep Mode*.

The R&S ZNL/ZNLE only supports the "Stepped" frequency sweep mode. Hence the content of the last column is always *Stepped*. During import, other values are silently replaced.

Remote command:

`MMEMory:LOAD:SEGment`

`MMEMory:STORe:SEGment`

Displayed Columns Dialog

The "Displayed Columns" dialog allows you to select the channel settings that can be defined per sweep segment. These settings are displayed in the [Define Segments Dialog](#) and in the "Point List" (opened via [Show Point List...](#)).

Access: [Define Segments Dialog](#) > "Displayed Columns..."

All segment-specific settings can be modified in the "Define Segments" dialog. By default, the first sweep segment is created with the channel settings defined for unsegmented sweep types. When any further sweep segment is created, it uses the channel settings of the previously active segment.



Related information

Refer to the following sections:

- [Chapter 10.5.2.2, "Define Segments Dialog"](#), on page 317
- ["Show Point List..."](#) on page 319

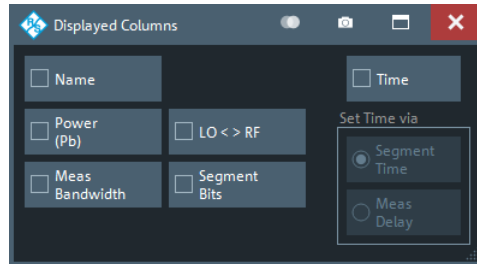

Optional Columns

Each selected (checked) option adds a column to the segment list and the point list.

- "Name" allows you to assign a name to each segment. A segment name is a string that is allowed to contain letters, numbers and special characters.
- "Power (Pb)" allows you to define the internal source power (channel base power) for each individual sweep segment. See ["Power"](#) on page 298.
- "Meas Bandwidth" defines the IF filter bandwidth for each individual sweep segment. See ["Bandwidth"](#) on page 307.
- "Selectivity" defines the selectivity of the IF filter used for each sweep segment. See ["Selectivity"](#) on page 307.
- "LO <> RF" allows you to define segment-specific "Image Suppr." settings; see ["Image Suppr."](#) on page 487.
- "Segment Bits" enables the definition of a segment-dependent 4-bit binary value to control four independent output signals at the Aux. Port connector (lines 16, 17, 18, 19; see [Chapter 15.3.1.1, "Aux. Port"](#), on page 1014). The output signals are 3.3 V TTL signals which can be used to differentiate between up to 16 independent analyzer states.

For an application example, refer to the detailed remote control description (`OUTPut<Ch>:UPORt:SEGment<Seg>[:VALue]`).

Setting the segment bits does not change the analyzer state.

- "Time" defines the sweep time for each segment. The default configuration for a new segment is equal to the sweep time setting for unsegmented sweeps; see ["Sweep Time / Auto"](#) on page 311.

When "Time" is checked, two new columns appear in the table. The first column is titled "Segment Time" or "Meas Delay", depending on the selected radio button below the "Time" checkbox. The second column is titled "Auto" and is used to activate automatic sweep time setting.

"Segment Time" is the total measurement time for the sweep segment. The minimum segment sweep time to be set is equal to the estimated value in "Auto" mode. "Meas Delay" sets a delay time allowing the DUT to settle before the hardware settings of the analyzer are changed and a new partial measurement is started.

Changing the "Meas Delay" modifies the "Segment Time" and vice versa.

"Auto" minimizes the sweep time. If "Auto" is selected for a segment, the columns "Segment Time" or "Meas Delay" (in the "Define Segments" dialog cannot be edi-

ted). "Segment Time" indicates the estimated sweep time, depending on the current measurement settings, the "Meas Delay" is 0 s. The segment sweep time and point delay values are maintained until changed explicitly if "Auto" is switched off.

Remote command:

```
[SENSe<Ch>:] SEGMENT<Seg>:POWER[:LEVEL]:CONTROL
[SENSe<Ch>:] SEGMENT<Seg>:POWER[:LEVEL]
[SENSe<Ch>:] SEGMENT<Seg>:BWIDTh[:RESolution]
[SENSe<Ch>:] SEGMENT<Seg>:BWIDTh[:RESolution]:CONTROL
[SENSe<Ch>:] SEGMENT<Seg>:BWIDTh[:RESolution]:SELECT
[SENSe<Ch>:] SEGMENT<Seg>:BWIDTh[:RESolution]:SELECT:CONTROL
[SENSe<Ch>:] SEGMENT<Seg>:DEFine
[SENSe<Ch>:] SEGMENT<Seg>:DEFine:SELECT
[SENSe<Ch>:] SEGMENT<Seg>:INSert
[SENSe<Ch>:] SEGMENT<Seg>:INSert:SELECT
[SENSe<Ch>:] SEGMENT<Seg>:SWEep:DWELl
[SENSe<Ch>:] SEGMENT<Seg>:SWEep:DWELl:CONTROL
[SENSe<Ch>:] SEGMENT<Seg>:SWEep:TIME
[SENSe<Ch>:] SEGMENT<Seg>:SWEep:TIME:CONTROL
[SENSe<Ch>:] SEGMENT<Seg>:SWEep:TIME:SUM?
OUTPut<Ch>:UPORt:SEGMENT<Seg>:STATe
OUTPut<Ch>:UPORt:SEGMENT<Seg>[:VALue]
CONTROl:AUXiliary:C[:DATA]
```

10.5.3 Trigger Tab

Selects the source of the trigger signal and provides additional trigger settings.

Trigger system of the analyzer

The trigger system is used to synchronize the analyzer's actions with events that can be provided by an internal or external signal or user-generated ("Manual Trigger"). Triggered measurements are an alternative to the default mode ("FreeRun", "Continuous" sweep), where the measurement is continuously repeated without fixed time reference.

Any trigger event can start an entire sweep or a part of it. Moreover, it is possible to switch off the RF source between consecutive triggered measurement sequences, and to define a delay between trigger events and the measurement sequences.



Background information

Refer to [Chapter 9.1.4.1, "Partial Measurements and Driving Mode"](#), on page 190.

10.5.3.1 Controls on the Trigger Tab



The trigger settings are also valid for calibration sweeps. Hence, in external trigger mode, the external trigger signal must be available during the system error correction, too. To start the calibration sweeps without delay, use the "FreeRun" trigger type.

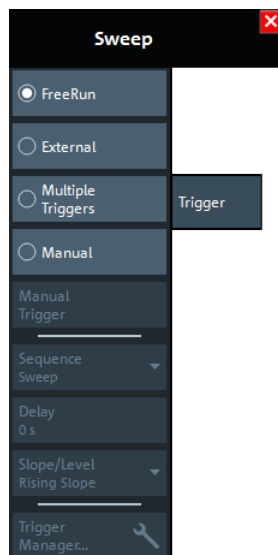

The following buttons in the "Trigger" tab open related dialogs:

- **"Trigger Manager...":** [Trigger Manager Dialog](#)

FreeRun / External / Manual / Multiple Triggers

These four buttons select the trigger source:

- In "FreeRun" mode, a new measurement is started immediately without waiting for a trigger event and without fixed time reference. The remaining trigger settings are not valid.
"FreeRun" means that a measurement in "Continuous" sweep mode is repeated as fast as possible.
- In "External" trigger mode, the measurement is triggered by an external 5 V TTL signal, applied to one of the following rear panel connectors:
 - BNC connector Trigger In
 - Pin 2 of the Aux. Port connector
(R&S ZNL only, requires [Additional Interfaces](#) option R&S FPL1-B5)

The trigger inputs are equivalent; no additional setting for signal routing is required. For detailed specifications of the trigger signals, refer to [Chapter 15.3.1.1, "Aux. Port"](#), on page 1014.

The "External" trigger mode can be configured using the [Sequence](#), [Delay](#) and [Signal Type](#) settings.

- In "Manual" trigger mode, the trigger signal is generated by the "Manual Trigger" button.
- If "Multiple Triggers" is active, the trigger sources for different triggered measurement sequences, the trigger slope, and the trigger delay can be selected individually using the [Trigger Manager Dialog](#).

In particular, it is possible to use two different external trigger sources (R&S ZNL only).

Remote command:

```
TRIGger<Ch>[:SEquence]:SOURce EXTernal
```

Manual Trigger

Generates the trigger event for "Manual" trigger mode and is disabled unless this mode is active.

Remote command:

```
TRIGger<Ch>[:SEquence]:SOURce MANual
```

*TRG

Sequence

Selects the measurement cycle or sequence of actions to be triggered in "External" or "Manual" mode.

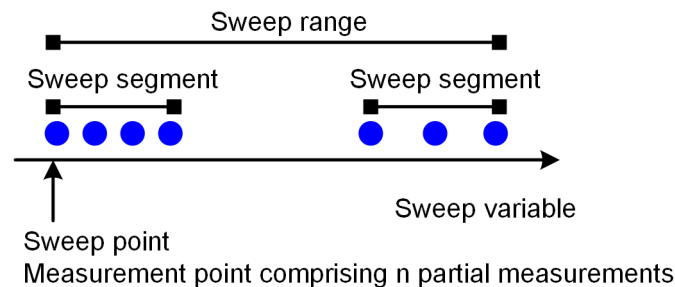

- "Sweep" means that each trigger event starts an entire sweep, according to the current sweep configuration.
- "Point" means that each trigger event starts the measurement at the next sweep point.
- "Partial Measurement" means that each trigger event starts the next partial measurement at the current or at the next sweep point. If every sweep point only requires a single partial measurement, this option is equivalent to "Point". See also [Chapter 9.1.4.1, "Partial Measurements and Driving Mode"](#), on page 190.
- "Segment" means that each trigger event starts the next sweep segment within the current sweep. If a sweep type other than [Segmented](#) is active, this option is equivalent to "Sweep".

Relation with other sweep settings

Some sweep settings are logically incompatible with a particular selection of the triggered measurement sequence:

- If a [Time](#) sweep is performed, the sequence is always a sweep.
- "Alternated" [Driving Mode](#) only makes sense if the triggered measurement sequence comprises more than one sweep point. If "Point" or "Partial Measurement" is selected, "Alternated" mode is switched off and vice versa.

Note: The trigger events must be adjusted to the triggered measurement sequence. If the analyzer receives a trigger event while the last sequence is still running, the R&S ZNL/ZNLE skips the trigger event and generates a message.

Remote command:

```
TRIGger<Ch>[:SEquence]:LINK
```

Delay

Specifies a delay time between the trigger event and the start of the next measurement sequence.

The specified "Delay" must be zero or positive, so that the trigger event precedes the start of the measurement (post-trigger).

If "Multiple Triggers" is active, the "Delay" can be selected individually using the [Trigger Manager Dialog](#).

Remote command:

```
TRIGger<Ch> [:SEquence] :HOLDoff
```

Signal Type

Specifies the "External" trigger mode in detail.

- **"Rising Edge"/"Falling Edge"** means that the rising/falling slope of every external trigger pulse can trigger a single measurement sequence.
- **"Active High"/"Active Low"** means that the analyzer measures in "FreeRun" mode as long as the external trigger signal is high/low. The measurement is discontinued when the trigger signal changes to low/high.

Remote command:

```
TRIGger<Ch> [:SEquence] :SLOPe
```

10.5.3.2 Trigger Manager Dialog

The "Trigger Manager" dialog defines individual trigger sources and delays for the triggered measurement sequences. The dialog is available and its settings are valid if the analyzer is configured for "Multiple Triggers" (see ["FreeRun / External / Manual / Multiple Triggers"](#) on page 323).

Access: [Sweep] > "Trigger" > "Trigger Manager..."

**Background information**

Refer to [Chapter 9.1.4.1, "Partial Measurements and Driving Mode"](#), on page 190.

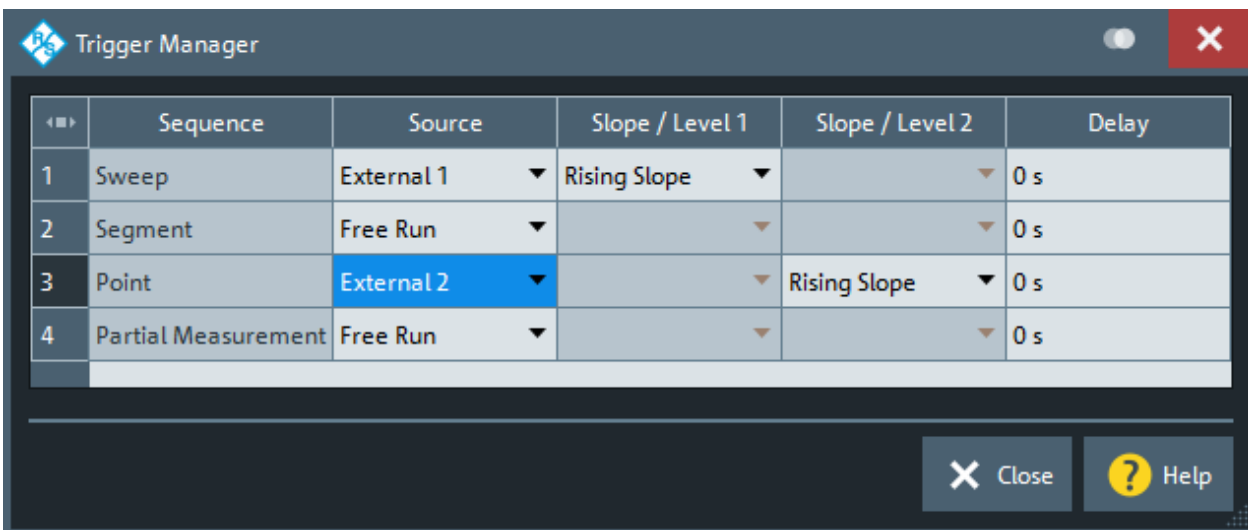

	Sequence	Source	Slope / Level 1	Slope / Level 2	Delay
1	Sweep	External 1	Rising Slope		0 s
2	Segment	Free Run			0 s
3	Point	External 2		Rising Slope	0 s
4	Partial Measurement	Free Run			0 s

Figure 10-3: Example of a multiple trigger configuration

The table in the "Trigger Manager" dialog contains several editable (white) or non-editable (gray) columns. All settings are analogous to the general trigger settings in the [Trigger Tab](#). Refer to the following sections:

- ["Sequence"](#) on page 324
- ["FreeRun / External / Manual / Multiple Triggers"](#) on page 323
- ["Signal Type"](#) on page 325
- ["Delay"](#) on page 325



The column "Slope / Level 2" is only available, if the instrument is equipped with a second external trigger input. This second external trigger input is provided by the Aux. Port connector, which is part of option R&S FPL1-B5 "Additional Interfaces" (R&S ZNL only).

... /Source/ ...

The table defines all settings related to "Multiple Triggers" (see [Chapter 10.5.3, "Trigger Tab"](#), on page 322). For all measurement sequences the following trigger sources are available:

- "Free Run" means that a trigger signal is not required
- "External 1" is the external trigger signal fed in at either the Trigger In connector on the rear panel or pin 2 of the Aux. Port connector.
- "External 2" is the external trigger signal fed in at pin 25 of the Aux. Port connector on the rear panel.
- "External 1 and 2"/"External 1 or 2" means that the measurement sequence is initiated after the analyzer has received an event from external trigger signal 1 and/or 2. A [Signal Type](#) must be specified for both trigger signals.
- **Manual** means that the trigger event is generated manually, by selecting the [Manual Trigger](#) button.

For example, a new sweep can be triggered by an external trigger no. 1, while the individual sweep points are triggered by external trigger no. 2. External trigger 1 is ignored if a sweep is running, external trigger 2 is ignored if there is no running sweep. In the figure below a sweep comprises 5 measurement points and dotted arrows depict ignored trigger events.

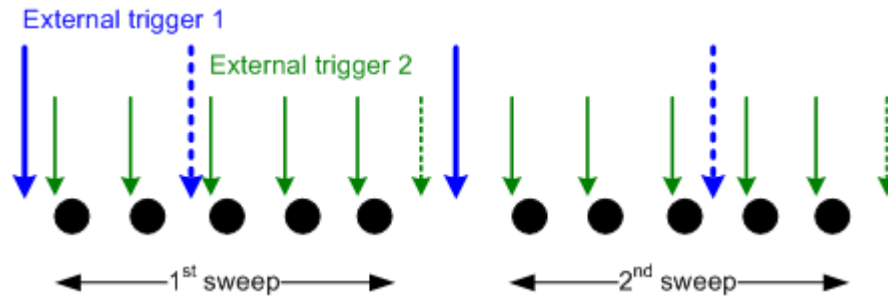

Remote command:

```
TRIGger<Ch>[:SEquence]:MULTiple:SOURce
TRIGger<Ch>[:SEquence]:MULTiple:SLOPe<Num>
TRIGger<Ch>[:SEquence]:MULTiple:HOLDoff
```

10.5.4 Sweep Control Tab

Allows you to control the sweep execution.

10.5.4.1 Controls on the Sweep Control Tab

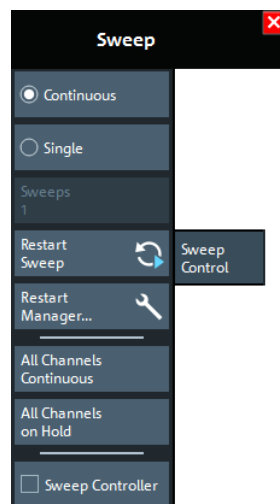

Continuous / Single

Activate either continuous (default) or single sweep mode.

- In "Continuous" sweep mode, the analyzer measures the related channel (or channels) continuously, repeating the current sweep over and over.
- In "Single" sweep mode, the measurement is stopped after the configured number of **Sweeps**.

[Restart Sweep](#) initiates a new measurement cycle.

This setting applies to the active channel.

Remote command:

```
INITiate<Ch>:CONTInuous
```

See also:

```
CONFigure:CHANnel<Ch>:MEASure[:STATe]
```

```
CONFigure:CHANnel:MEASure:ALL[:STATe]
```

Sweeps

Defines the number of sweeps to be performed in "Single" sweep mode (see "[Continuous / Single](#)" on page 327).

This setting applies to the active channel. In "Continuous" sweep mode, it is not available (grayed out).

Remote command:

```
[SENSe<Ch>:]SWEep:COUNT
```

```
[SENSe:]SWEep:COUNT:ALL
```

Restart Sweep

Stops the current measurement cycle and starts a new one.

The effect of this command depends on the [sweep modes](#) of the active channel, and the restart behavior defined in the [Restart Manager Dialog](#):

	"Sweep Active Channel"	"Sweep All Channels"
Active channel in "Continuous" sweep mode	The "Continuous" sweep mode channels are swept cyclically, the "Single" sweep channels are on hold.	First the "Single" sweep mode channels are swept one after the other, each with its channel-specific number of "Sweeps". Then the "Continuous" sweep mode channels are sweep cyclically.
Active channel in "Single" sweep mode	First the active channel is swept with its channel-specific number of "Sweeps". Then the "Continuous" sweep mode channels are sweep cyclically.	

Remote command:

```
INITiate<Ch>[:IMMediate][:DUMMy]
```

```
INITiate[:IMMediate]:ALL
```

Restart Manager...

Opens the [Restart Manager Dialog](#).

All Channels Continuous/All Channels on Hold

Selects a common [sweep mode](#) for all channels of the active channel setup.

- "All Channels Continuous": all channels are set to "Continuous" sweep mode
- "All Channels on Hold": all channels are set to "Single" sweep mode.

[Restart Sweep](#) initiates a new measurement cycle.

Remote command:

```
INITiate:CONTInuous:ALL
```

Sweep Controller

Activates/deactivates the (resizable) "Sweep Info" dialog, which displays the current sweep stage. The "Sweep Info" dialog is particularly useful for long duration sweeps that are executed in single sweep mode: by observing the dialog, it is easy to realize when the sweep is done.



The possible sweep stages and how they are displayed partly depend on the selected sweep mode (see "[Continuous / Single](#)" on page 327):

Sweep stage	Sweep controller display	
	in "Continuous" sweep mode	in "Single" sweep mode
No ongoing sweep	<i>Idle</i>	<i>Idle</i>
Sweep is being prepared	<i>Preparing</i>	<i>Preparing</i>
Ongoing sweep ¹⁾	<i>Continuous</i>	<i>Sweeping</i> if #Sweeps = 1
		<i>Sweeping m/n</i> if n = #Sweeps > 1
Measurement results are being calculated	<i>Continuous calculation</i>	<i>Calculation</i>
¹⁾ The VNA is sweeping or waits for a trigger signal.		

10.5.4.2 Restart Manager Dialog

The "Restart Manager" dialog defines the [Restart Sweep](#) behavior in "Single" sweep mode.

Access: [Sweep] > "Sweep Control" > "Restart Manager..."



Related information

Refer to [Chapter 9.1.4, "Sweep Control"](#), on page 189.

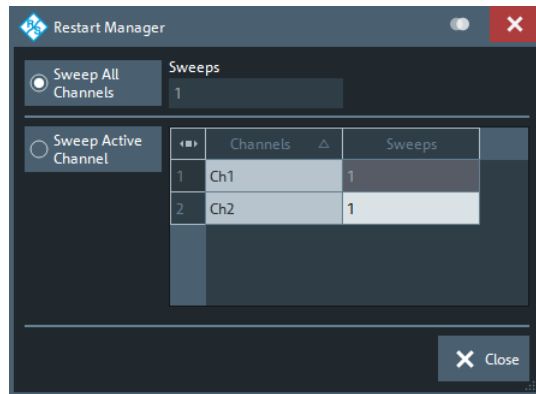

Sweep All Channels/Sweeps

If you select "Sweep All Channels", [Restart Sweep](#) restarts the sweep in all channels of the active channel setup.

The number of sweeps in "Single" [sweep mode](#) channel is channel-specific and can be defined in the table below the separator line. The "Sweeps" column reflects the [Sweeps](#) settings of the individual channels. The "Sweeps" setting above the separator line is unused and disabled.

Tip: In remote control, it is possible to retrieve the results acquired in any of the sweeps within a single sweep group.

Remote command:

```
INITiate[:IMMEDIATE]:ALL
INITiate<Ch>[:IMMEDIATE]:SCOPE ALL
[SENSe<Ch>:]SWEep:COUNT
```

Sweep Active Channel/Sweeps (table)

If you select "Sweep Active Channel", then in single sweep mode [Restart Sweep](#) only restarts the sweep in the active channel.

The "Sweeps" column reflects the [Sweeps](#) settings of the individual channels.

Remote command:

```
INITiate<Ch>[:IMMEDIATE]:SCOPE SINGLE
[SENSe<Ch>:]SWEep:COUNT
```

10.6 Trace Softtool

The Trace softtool provides functions for managing traces.

Access: [Trace]

10.6.1 Traces Tab

Provides functions to handle traces and diagram areas, and assign traces to channels.



Related information

Refer to [Chapter 9.1.3, "Traces, Channels and Diagrams"](#), on page 187.



In remote control, each channel can contain an active trace. The active remote traces and the active manual trace are independent of each other; see [Chapter 11.4.2.2, "Active Traces in Remote Control"](#), on page 577.

10.6.1.1 Controls on the Traces Tab

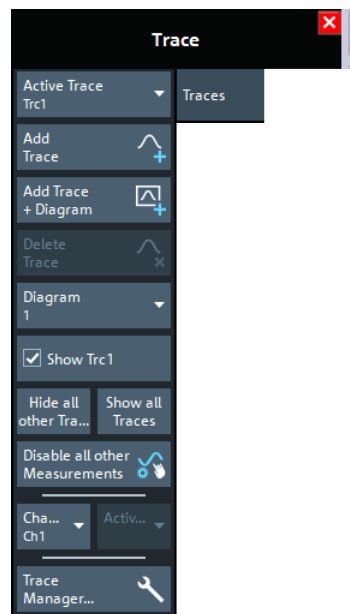

The "Trace Manager..." button opens the [Trace Manager Dialog](#).

Active Trace

Selects an arbitrary trace of the active channel setup as the active trace in its channel and diagram. At the same time, it sets the trace's diagram and channel as the active [Diagram / Channel](#).

Tip: You can also select an item in a trace list or a trace line in a diagram to make the related trace the active one.

This function is disabled if only one trace is defined.

Add Trace

Creates a trace in the active [Diagram / Channel](#) and makes it the [Active Trace](#).

The new trace is created with the settings of the former active trace, but displayed in another color. The former and the new active trace overlay each other. Change the reference position or select a different measurement for the new trace to separate them (see [Chapter 10.7, "Meas Softtool"](#), on page 375).

The new trace is named "Trc<n>", where <n> is the largest of all existing trace numbers plus one. The name can be changed in the [Trace Manager Dialog](#).

Remote command:

```
CALCulate<Ch>:PARAmeter:SDEFine
DISPlay[:WINDow<Wnd>]:TRACe<WndTr>:FEED
```

Add Trace + Diagram

Creates a trace in the active channel and assigns it to a new diagram. Otherwise behaves like [Add Trace](#).

Remote command:

```
CALCulate<Ch>:PARAmeter:SDEFine
DISPlay[:WINDow<Wnd>][:STATe] ON
DISPlay[:WINDow<Wnd>]:TRACe<WndTr>:FEED
```

Delete Trace

Deletes the active trace and removes it from the diagram area. If the active diagram contains only one trace, the diagram is also deleted.

"Delete Trace" is disabled if the active channel setup contains only one trace. In manual control, each channel setup must contain at least one diagram area with one channel and one trace.

Tips:

- You can also hide traces without actually deleting them: remove the corresponding "On" flags in the "Trace Manager" (see [Chapter 10.6.1.2, "Trace Manager Dialog"](#), on page 333).
- Use the undo function to restore a trace that was unintentionally deleted.

Remote command:

```
CALCulate<Ch>:PARAmeter:DELeTe
CALCulate:PARAmeter:DELeTe:ALL
CALCulate<Ch>:PARAmeter:DELeTe:CALL
```

Diagram / Channel

Displays the active diagram and channel, i.e. the diagram and channel of the [Active Trace](#). Allows you to move the active trace to another diagram or channel.

Remote command:

```
DISPlay[:WINDow<Wnd>]:TRACe<WndTr>:FEED
```

Show <Trace Name> / Hide All Other Traces / Show All Traces

Configures the visibility of the traces in the active diagram:

- "Show <Trace Name>" toggles the visibility of the [Active Trace](#)
- "Hide All Other Traces" hides all traces of the active diagram – except the active one (which can be visible or not)
- "Show All Traces" makes all traces of the active diagram visible

Note:

- These actions can also be performed from the context menu of the trace name segment in the trace list (see [Chapter 9.2.1.4, "Channel List and Channel Settings"](#), on page 205).
- Use the "On" flags in the "Trace Manager" to show/hide arbitrary sets of traces (see [Chapter 10.6.1.2, "Trace Manager Dialog"](#), on page 333).

Disable all other Measurements/Enable all Measurements

Toggle button with alternating caption.

"Disable all other Measurements" • Disables all channels, except the active one
 • Disables all traces in the active channel, except the active one
 • Hides all diagrams except the active one

"Enable all Measurements" Restores the previous channel/trace/diagram configuration

Same functionality as the

10.6.1.2 Trace Manager Dialog

The "Trace Manager" dialog allows you to perform operations on traces.

Access: [Trace] > "Traces" > "Trace Manager..."



All existing traces of the current channel setup are listed in a table with several editable (white) or non-editable (gray) columns.

Table Area

The table contains the following columns:

- "Name" indicates name of the related trace.
Trace names must be unambiguous across all channels and diagram areas in a channel setup.
- "On" indicates and controls the visibility of the related trace.
- "Label" indicates and controls the visibility of the related trace label
- "Meas" indicates the measured parameter.
- "Type" indicates whether the trace is a data trace ("DAT"), displaying the current measurement data, or a memory trace ("MEM").
- "Channel" indicates and controls the channel to which the related trace is assigned. Data traces and their associated memory traces are always assigned to the same channel.
- "Diagram" indicates and controls the diagram area to which the related trace is assigned.
- "Scale" indicates and controls the scale coupling of the related trace. A trace's scaling can either be uncoupled ("Scale" empty) or coupled to another trace's scaling.

Rules for trace names

The analyzer can define mathematical relations between different traces and calculate new mathematical traces ("User Def Math"). The trace names are used as operands in the mathematical expressions and must be distinguished from the mathematical operators +, -, *, /, (,) etc., which places some restrictions on the syntax of trace names.

- The first character of a trace name can be one of the following:
 - an upper case letter from A to Z, or lower case letter from a to z
 - an underscore _
 - a square bracket [or]
- For all other characters of a trace name, the numbers 0 to 9 can be used in addition.

Note: The analyzer does not accept illegal or ambiguous trace names. If an illegal or ambiguous name is specified, the entry is denied.

Remote command:

`CONFigure:TRACe:CATalog?`

`CONFigure:CHANnel<Ch>:TRACe:CATalog?`

`CONFigure:TRACe<Trc>:REName`

`CONFigure:CHANnel<Ch>:TRACe:REName`

`DISPlay[:WINDow<Wnd>]:TRACe<WndTr>:SHOW`

`DISPlay[:WINDow<Wnd>]:TRACe<WndTr>:LABel:SHOW` on page 764

`CONFigure:TRACe:WINDow:TRACe?`

`DISPlay[:WINDow<Wnd>]:TRACe<WndTr>:FEED`

`CONFigure:CHANnel<Ch>:NAME:ID?`

Add

Creates a trace based on the [Active Trace](#). In particular, the trace is assigned to the channel and diagram of the active trace. However, its "Scale" coupling is not adopted.

The default names for new traces are "Trc<n>", where <n> is selected by the analyzer firmware to make trace names unambiguous.

Remote command:

`CALCulate<Ch>:PARAmeter:SDEFine`

Delete

Deletes the selected trace.

This button is disabled if the channel setup contains only one trace: In manual control, each channel setup must contain at least one diagram area with one channel and one trace.

Remote command:

`CALCulate<Ch>:PARAmeter:DElete`

Couple All Channels / Decouple All Channels

- "Couple All Channels" assigns all traces to the channel of the active trace, deleting all other (now unused) channels. The analyzer displays a confirmation dialog box before deleting the unused channels.
- "Decouple All Channels" makes sure that each data trace is assigned its own (independent) channel.

For data traces previously assigned to the same channel, new channels are created based on the original channel's settings. Data traces and their associated memory traces are assigned to the same channel.

Remote command:

n/a

Couple All Scales / Decouple All Scales

- "Couple All Scales" couples the scale settings of all traces to the scale settings of the active trace. The scale settings of the other traces are lost.
- "Decouple All Scales" applies independent scale settings to all traces. If trace A is coupled to trace B, then B's scale settings are copied to A.

Remote command:

n/a

10.6.2 Mem

Stores traces to the memory.



Background information

Refer to "[Trace Types](#)" on page 197.

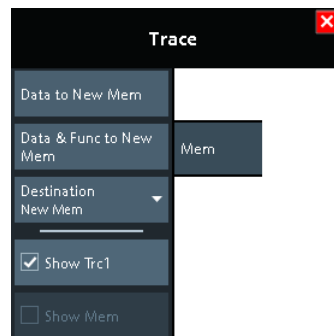

Coupling of data and memory traces

When a memory trace is generated from a data trace, it is displayed in the same diagram area and inherits all channel and trace settings from the data trace. The memory trace displayed in the active diagram; its properties are indicated in the trace list:



New memory traces are named "Mem<n>[<Data Trace>]", where:

- <n> counts all data and memory traces in the active channel setup in chronological order
- <Data_Trace> is the name of the associated data trace

Trace names can be changed in the [Trace Manager Dialog](#).

The following display settings of a data trace and the associated memory traces are **fully coupled**. Changing a property of one trace affects the properties of all other traces.

- All "Format" settings (see [Chapter 10.8, "Format Softtool"](#), on page 395)
- All "Scale" settings (see [Chapter 10.3, "Scale Softtool"](#), on page 300)

Selection of the measured quantity (using the [Meas Softtool](#)) is possible for the data trace but disabled for the memory traces.

Channel settings made for a memory trace act on the associated data trace. Some of the channel settings for a data trace (e.g. the "Stimulus" range) also affect the display of the memory traces.



If, due to a change of the sweep type, the stimulus type of a data trace changes, all its memory traces are deleted.

Active Trace vs. Active Data Trace

In the context of memory traces we distinguish between the active trace and the active data trace.

- If the active trace is a memory trace, then the active data trace is the data trace to which the memory trace is associated.
- If the active trace is a data trace, then the active trace is also the active data trace.

Data to <Destination>

Stores the current state of the active data trace to the [Destination](#) memory trace. No trace functions are applied to the stored trace.

Tips:

- Use [Data & Func to <Destination>](#) to apply trace functions to the stored trace.
- You can also create memory traces using the [Import Complex Data Dialog](#).
- It is not possible to store [Hold](#) traces to memory.
- For the relation between a data trace and its associated memory traces, see "[Coupling of data and memory traces](#)" on page 335.

Remote command:

```
CALCulate<Chn>:MATH:MEMorize
TRACe:COPI
```

Data & Func to <Destination>

Stores the current state of the active data trace – including trace functions – to the [Destination](#) memory trace.

Trace functions

The trace functions comprise the following mathematical operations:

- Active trace math on unformatted and formatted traces, as configured in the [Chapter 10.6.4, "Math Tab"](#), on page 339.
- A shift of the data trace (see "[Shift Trace](#)" on page 365).

[Data to <Destination>](#) stores the raw trace without the trace functions, "Data & Func to <Destination>" stores the trace after it has been transformed using the trace functions.

For the relation between a data trace and its associated memory traces, see "[Coupling of data and memory traces](#)" on page 335.

Remote command:

```
CALCulate<Chn>:MATH:MEMorize
```

Destination

Selects the destination for the [Data to <Destination>](#) and [Data & Func to <Destination>](#) operations.

The destination can be one of the following:

- An existing memory trace of the active data trace.
The existing memory trace is overwritten.
- "New Trace"
The data are copied to a new memory trace, associated to the current data trace.

Remote command:

n/a

Show <Active Data Trace>

Shows or hides the active data trace in the diagram.

Remote command:

```
DISPlay[:WINDow<Wnd>]:TRACe<WndTr>:SHOW
```

Show <Mem>

Shows or hides the active memory trace or the first memory trace of the active data trace.

If no memory trace is associated with the active data trace, "Show <Mem>" is disabled.

Remote command:

```
DISPlay[:WINDow<Wnd>]:TRACe<WndTr>:SHOW
```

10.6.3 All Mem All Data Tab

Performs actions on all data or memory traces in the active channel setup.



Background information

Refer to "[Trace Types](#)" on page 197.

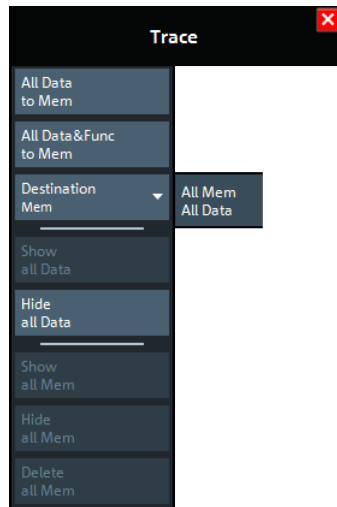

All Data to <Destination>

Stores the current data of all data traces in the active channel setup to memory traces, in accordance with the [Destination](#) setting. No trace functions are applied to the stored traces.

Remote command:

`TRACe:COPI`

All Data & Func to <Destination>

Stores the current data of all data traces in the active channel setup to memory traces, in accordance with the [Destination](#) setting. Trace functions are applied to the stored traces.

For information on trace functions, see "[Data & Func to <Destination>](#)" on page 336.

[All Data to <Destination>](#) stores the raw trace without the trace functions, "[All Data & Func to <Destination>](#)" stores the trace after it has been transformed using trace functions.

Remote command:

`CALCulate<Chn>:MATH:MEMorize`

Destination

Selects the destination for the [All Data to <Destination>](#) and [All Data & Func to <Destination>](#) functions, that operate on all data traces in the active channel setup.

- **"Mem"**:
For each data trace with associated memory traces, the current trace data are copied to the first associated memory trace, overwriting existing data. For data traces without associated memory trace, the current trace data are copied to a new memory trace, associated to this data trace.
- **"New"**:
For each data trace, the current trace data are copied to a new memory trace, associated to this data trace.

New memory traces are named "Mem<n>[<Data_Trace>]" with <n> selected by the analyzer firmware to make trace names unique.

Remote command:
n/a

Show All Data / Hide All Data / Show All Mem / Hide All Mem

Displays or hides all data or memory traces in the active channel setup. Hidden traces are not deleted.

Remote command:

`DISPlay[:WINDow<Wnd>]:TRACe<WndTr>:SHOW`

Delete All Mem

Deletes all memory traces in the active channel setup.

Tips:

- Use the [Trace Manager Dialog](#) to hide or delete arbitrary sets of traces.
- Use the UNDO function of the analyzer to restore a trace that was unintentionally deleted.

Remote command:

`CALCulate:PARAmeter:DELeTe:MEMory`

10.6.4 Math Tab

Allows you to define mathematical operations on traces.



Background information

Refer to "[Trace Types](#)" on page 197.

10.6.4.1 Controls on the Math Tab

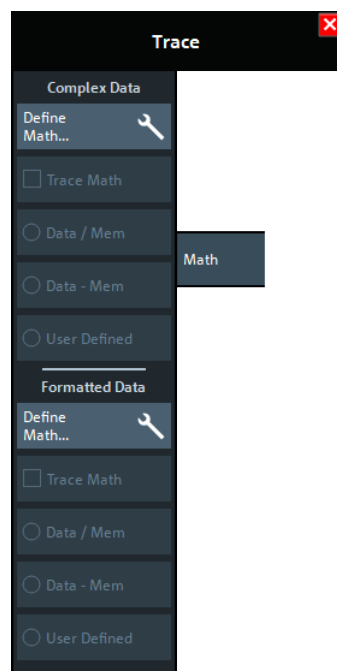

The "Define Math..." buttons in the "Complex Data" and "Formatted Data" sections both open the [User Def Math Dialog](#), but with different scope:

- "Complex Data" > "Define Math..." defines mathematical operations on raw complex trace data.
- "Formatted Data" > "Define Math..." defines mathematical operations on formatted trace data.

Both can be combined.

Complex Data/Formatted Data

The controls in the "Complex Data" section define math operations on raw complex trace data, the controls in the "Formatted Data" section define math operations on formatted trace data.

"Complex Data" math is available in all firmware versions of all R&S ZNx vector network analyzers. "Formatted Data" math was added in version 1.30 of the R&S ZNL/ZNLE firmware.

Trace Math ← Complex Data/Formatted Data

Activates or deactivates the "Complex Data" and/or "Formatted Data" formula previously defined using [Data / <Mem>](#), [Data - <Mem>](#), or "Define Math..." (via [Chapter 10.6.4.2, "User Def Math Dialog"](#), on page 341).

Trace math for unformatted and formatted trace data can be active at the same time.

Trace Math ← Complex Data/Formatted Data

Activates the mathematical mode, applying the last active mathematical relation to the active trace. The trace is replaced by the mathematical trace and Math is displayed in the trace list while the mathematical mode is active:

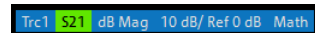

"Trace Math" is enabled if the active data trace fulfills the conditions for evaluating the mathematical relation. E.g., if no "User Defined" mathematical relation is defined, a memory trace must be coupled to the active data trace, so that the R&S ZNL/ZNLE can evaluate one of the relations "Data / <Mem>" or "Data - <Mem>".

Remote command:

```
CALCulate<Chn>:MATH:STATE
```

```
CALCulate<Chn>:MATH:FORMatted:STATE
```

Data / <Mem>, Data - <Mem> ← Complex Data/Formatted Data

Activates the mathematical mode with the corresponding trace mathematical operation. The division (subtraction) is calculated on a point-to-point basis: Each measurement point of the active trace is divided by (subtracted from) the corresponding measurement point of the memory trace. If the memory trace represents the result of a previous sweep with unchanged settings, the divided (subtracted) curve is typically centered at 1 / 0 dB (0). It shows the variation of the results in subsequent sweeps.

The result of the division is a mathematical trace and replaces the active data trace in the diagram area. The mathematical trace is updated as the measurement goes on and the analyzer provides new active trace data.

This function is disabled unless a memory trace is coupled to the active data trace. Trace coupling ensures that the two traces have the same number of points so that the mathematical trace is well-defined.

Remote command:

`CALCulate<Chn>:MATH:FUNCTION`

`CALCulate<Chn>:MATH:FORMatted:FUNCTION`

User Defined ← Complex Data/Formatted Data

Activates the mathematical mode and displays the mathematical trace defined using in the "User Def Math" dialog (see [Chapter 10.6.4.2, "User Def Math Dialog"](#), on page 341).

The mathematical trace replaces the active data trace in the diagram area; it is updated as the measurement goes on and the analyzer provides new active trace data.

Remote command:

`CALCulate<Chn>:MATH:STATE`

10.6.4.2 User Def Math Dialog

The "User Def Math" dialog defines a mathematical trace for the active trace. Each measurement point of the original trace is replaced by the corresponding point of the mathematical trace.

Access: [Trace] > Math > Complex Data/Formatted Data section > "Define Math..."

Depending on the section from where the dialog is opened, the calculation is either based on unformatted or formatted trace data.

Compatibility between traces in mathematical relations

Mathematical traces are either constant functions or functions of one or more data or memory traces. They are calculated on a point-to-point basis. Each trace point no. i of the mathematical trace is calculated from a set of constant values c_1, \dots, c_n plus the trace points $Trc1_i, Trcm_i$ of all traces 1 to m in the mathematical relation:

$$\text{Math}_i = \text{Fct.} (c_1, \dots, c_n, \text{Trc1}_i, \text{Trcm}_i), i = 1, \text{no. of points}$$

Different traces can be used in the same mathematical relation provided that they contain the same number of points. The analyzer places no further restriction on the compatibility of traces, e.g. the sweep points of the traces do not have to be the same.

The number of points belongs to the channel settings. Coupled data and memory traces are always compatible because they have the same channel settings.



The analyzer processes only numeric values without units in the mathematical formulas. No consistency check for units is performed.

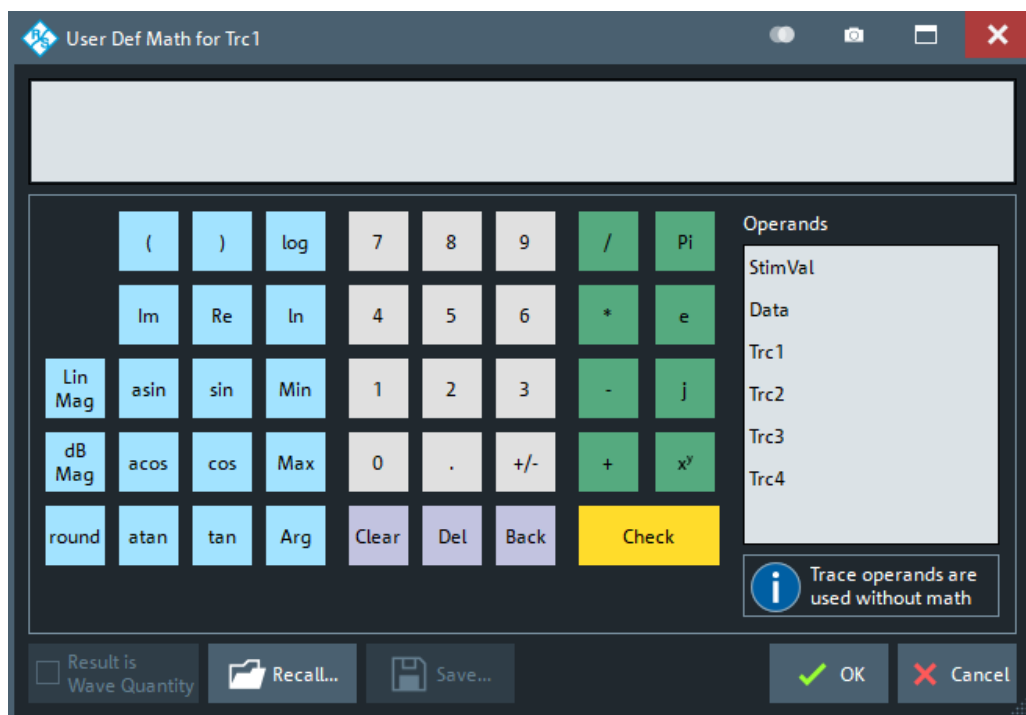

Expression builder

The mathematical expression appears in the upper part of the dialog. The operands and operators in the expression can be selected from a keyboard and the list of "Operands":

- The keyboard supports the entry of numeric values, constants, and mathematical functions. In addition to the numbers 0 to 9, the decimal point and the constants j (complex unit), pi (approx. 3.14159) and e (approx. 2.71828), it contains the following buttons:
 - +/- changes the sign
 - The effect of the basic arithmetic operators ($/$, $*$, $-$, $+$) and the mathematical functions is described in [Table 10-2](#).
Products of numbers and constants may be entered in abbreviated form, e.g. 2e for $2*e$.
 - The Clear, Del, Back buttons are used to correct faulty entries.
 - Check performs a consistency check of the displayed mathematical expression and displays a message.
- "Operands" contains all data traces and memory traces of the active channel setup.
 - Data and memory traces are identified by their trace names.
 - "Data" denotes the active data trace.
 - "Mem" is the memory trace associated with the active data trace (or the first created one, if several memory traces are associated with the active data trace).
 - "StimVal" is the array of stimulus values; see footnote for [Table 10-2](#).

The trace operands denote *unmodified* data and memory traces. Trace math and other trace functions ("Smoothing", "Hold", "Shift Trace" etc.) are not taken into account.

Table 10-2: Effect of the operators on a complex quantity $z = x + jy$.

+ , - , * , /	Basic arithmetic operations
()	Grouping parts of an expression
Lin Mag	$ z = \text{sqrt} (x^2 + y^2)$
dB Mag	$\text{dB Mag}(z) = 20 * \log z \text{ dB}$
round	x real \Rightarrow round(x) rounds x to the closest integer (away from zero for ties) x,y real \Rightarrow round(x+yj) = round(x)+round(y)j
x^y	Exponential, e.g. z^2
Arg	Phase $\phi (z) = \arctan (\text{Im}(z) / \text{Re}(z))$
Re, Im	x, y (Real and Imag)
log, ln	Common (base 10) or natural (base e) logarithm
Min, Max	Smaller or larger values of all points of two traces, e.g. Min(Trc1,Trc2)
StimVal *)	Stimulus value*)
tan, atan, sin, asin, cos, acos	Direct and inverse trigonometric functions.

*) The operand "StimVal" can be used for all sweep types. Please note that – as with all user math operands – only the numerical value without unit is processed in the user math formula.

- In frequency sweeps "StimVal" provides the stimulus frequency in Hz.
- In time sweeps, "StimVal" is the stimulus time in s.
- In CW mode sweeps, "StimVal" is the number of the point.

Remote command:

```
CALCulate<Chn>:MATH[:EXPRession]:SDEFine
```

```
CALCulate<Chn>:MATH:FORMatted[:EXPRession]:SDEFine
```

Result is Wave Quantity

"Result is Wave Quantity" controls the conversion and formatting of the mathematic expression.

This switch is available for **unformatted** trace data (Complex Data) only.

- If "Result is Wave Quantity" is enabled, the analyzer assumes that the result of the mathematical expression represents a voltage. Examples for voltage-type expressions are all terms proportional to a wave quantity (e.g. $1.1 * \text{Data}$, if a wave quantity is measured).
If "Show as": "Power" is selected in the "More Wave Quantities" dialog, the result is converted into a linear power before the selected trace format is applied. Otherwise no conversion is performed, and "dB Mag" results are referenced to $1 \mu\text{V}$.
- If "Result is Wave Quantity" is disabled the analyzer assumes that the result of the mathematical expression is dimensionless. Examples for dimensionless expressions are all terms proportional to ratios of wave quantities, e.g. $\text{Data} / \text{Mem2}[\text{Trc1}]$. The selected trace format is applied without previous conversion.

"Result is Wave Quantity" acts on the result of the mathematical expression only. Wave quantities always enter into the expression as voltages.

Effect of "Result is Wave Quantity"

In the [More Wave Quantities Dialog](#), the "Show as" control element specifies whether wave quantities are displayed as voltages or equivalent powers, using the port impedances for a conversion between the two representations. "Result is Wave Quantity" is relevant for mathematical traces displayed in units of dBm ("Show as": "Power" and trace format "dB Mag"):

If "Result is Wave Quantity" is on (checked), the mathematical trace values $\langle W \rangle$ are interpreted as voltages and first converted into equivalent powers ($\langle W \rangle \rightarrow \langle P \rangle = \langle W \rangle^2 / \text{Re}(Z_0)$). Results in "dB Mag" format are calculated according to $\langle P \rangle_{\log} = 10 * \log(\langle P \rangle / 1\text{mW})$.

- If "Result is Wave Quantity" is off, the mathematical trace values $\langle W \rangle$ are interpreted as dimensionless quantities. Results in "dB Mag" format are calculated according to $\langle W \rangle_{\log} = 20 * \log(\langle W \rangle)$.

Example:

A mathematical trace value amounts to 1 (real value); the port impedance is 50 Ω. If "Result is Wave Quantity" is on, the analyzer assumes the trace value to be 1 V, which is converted into a linear power of 20 mW, corresponding to approx. 13 dBm. With "Result is Wave Quantity" off, the trace value 1 is directly converted into a logarithmic power of 0 dBm.

Tip: See also example for `CALCulate<Chn>:MATH:WUNit:STATe`.

Remote command:

```
CALCulate<Chn>:MATH:WUNit[:STATe]
```

Recall... / Save...

Recalls / saves a mathematical expression from / to a trace math string file. Trace math string files are ASCII files with the default extension `*.mth` and contain the mathematical expression as it is written in the "User Def Math" dialog. It is possible to change or create math string files using a text editor.

Remote command:

```
CALCulate<Chn>:MATH:WUNit[:STATe]
```

10.6.5 Time Domain Tab

The "Time Domain" tab enables and configures the time domain representation of the measurement results.



- Time domain analysis requires option R&S ZNL-K2. If this option is not installed, the "Time Domain" and [Time Gate Tab](#) tabs are hidden.
- Since firmware version 1.30, this option is also available for the R&S ZNLE.



Background information

Refer to [Chapter 9.7.1, "Time Domain Analysis"](#), on page 282.

For a comparison of the different transformation types and windows, and for application examples, please also refer to the application note 1EZ44_OE (<https://www.rohde-schwarz.com/appnote/1EZ44>).

10.6.5.1 Controls on the Time Domain Tab

The contents of the "Time Domain" tab are also displayed on the "Meas" softtool for non-frequency converting DUTs.

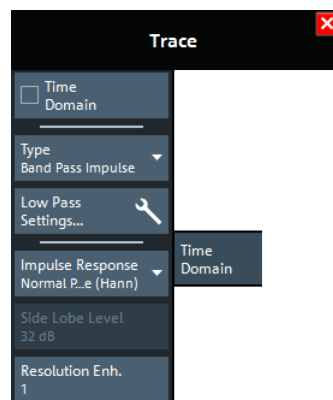

"Low Pass Settings..." opens the [Low Pass Settings Dialog](#).

Time Domain

Selects the time domain representation for the active diagram area. The softkey is enabled if a linear frequency sweep is active (see ["Lin Freq"](#) on page 312). The analyzer automatically quits time domain representation when a different sweep type is selected.

The time domain results are obtained by transforming the measured frequency sweep data into the time domain using an appropriate mathematical transformation type and frequency window ("Impulse Response"). The sweep range and the output power for the active channel is still displayed below the diagram; the displayed time interval is shown in a second line:

```
Ch1 Start 1 MHz Pwr -10 dBm Bw 10 kHz Stop 3 GHz
Trc1 Start -1 ns Time Domain Stop 4 ns
```

Trace settings in time domain representation

While the time domain representation is active, the trace settings behave as follows:

- The "Start" and "Stop" settings in the "Time Gate" tab configure the time axis.
- All trace formats including the circular diagrams are available.
- Limit lines can be defined like the limit lines for time sweeps.
- The bandfilter search functions are available for the transformed trace.
- If marker coupling is active, then the markers in the time domain and in the frequency domain are coupled with each other.

The analyzer places no restriction on the measured quantities to be transformed into the time domain. Impedances and admittances are first converted back into the equivalent S-parameter, transformed, and restored after the transformation.

See also [Chapter 9.7.1.1, "Chirp z-Transformation"](#), on page 282.

Remote command:

```
CALCulate<Chn>:TRANSform:TIME:STATE
```

Type

Selects a band pass or low pass time domain transform. See [Chapter 9.7.1.2, "Band Pass and Low Pass Mode"](#), on page 283.

To calculate a low pass transform, the sweep points must be on a harmonic grid. Otherwise the analyzer can only calculate an approximate result and generates a warning. "Low Pass Settings..." opens a dialog that allows to establish or change a harmonic grid (not available for memory traces). See [Chapter 10.6.5.2, "Low Pass Settings Dialog"](#), on page 347.

Remote command:

```
CALCulate<Chn>:TRANSform:TIME[:TYPE]
```

```
CALCulate<Chn>:TRANSform:TIME:STIMulus
```

Impulse Response

Selects a window type which the R&S ZNL/ZNLE uses to filter the trace in the frequency domain. The drop-down list shows the impulse response of a constant trace over a finite sweep range (i.e. a rectangular function) that was filtered using the different available window types. The selected window is applied to the active trace.

See also [Chapter 9.7.1.3, "Windows in the Frequency Domain"](#), on page 284.

Note: The frequency domain window is used to filter the trace before transforming it to the time domain. An independent "Time Gate" can be used after the transformation to eliminate unwanted responses (see [Chapter 10.6.6, "Time Gate Tab"](#), on page 349).

The analyzer always uses a "No Profiling (Rectangle)" window to calculate the time-gated frequency domain trace, see ["Time-Gated Frequency Domain Trace"](#) on page 287.

Remote command:

```
CALCulate<Chn>:TRANSform:TIME:WINDow
```

Side Lobe Level

Defines the side lobe suppression for an "Arbitrary Sidelobes (Dolph-Chebyshev)" window. The entered value is the ratio of the power of the central lobe to the power of the first side lobe in dB.

Remote command:

```
CALCulate<Chn>:TRANSform:TIME:DCHebyshev
```

Resolution Enh.

Broadens the frequency range that the analyzer considers for the time domain transform by a linear factor. A factor of 1 means that the original sweep range and the measured sweep points are used; no additional assumptions are made. With higher resolution enhancement factors, the measurement data is extrapolated using a linear prediction method. As a result, the resolution in time domain can be improved.

The ideal resolution enhancement factor depends on the properties of the DUT. For distance to fault measurements on cables, set it to 1.

Remote command:

```
CALCulate<Chn>:TRANSform:TIME:RESolution:EFACtor
```

10.6.5.2 Low Pass Settings Dialog

The "Low Pass Settings" dialog defines the harmonic grid for low pass time domain transforms.

Access: [Trace] > "Time Domain" > "Low Pass Settings..."



Background information

Refer to [Chapter 9.7.1.4, "Harmonic Grid"](#), on page 284.

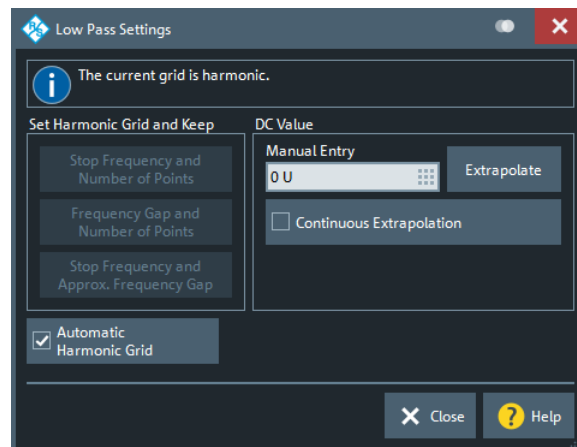

Is the Current Grid Harmonic?

The area at the top of the "Low Pass Settings" dialog indicates whether the current frequency grid is harmonic.

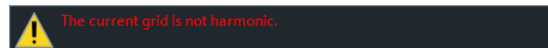

Remote command:

```
[SENSe<Ch>:]HARMonic?
```

Set Harmonic Grid and Keep

The three buttons provide alternative algorithms for calculation of a harmonic grid, based on the current sweep points.

- Keep "Stop Frequency and Number of Points" calculates a harmonic grid based on the current "Stop Frequency" (see ["Start Frequency / Stop Frequency / Center Frequency / Span Frequency"](#) on page 296) and the current number of sweep points (see ["Number of Points"](#) on page 310). This algorithm can increase the frequency gap (i.e. the [Freq Step Size](#)).

- Keep "Frequency Gap and Number of Points" calculates a harmonic grid based on the current "Stop Frequency" and the current frequency gap (i.e. the "Freq Step Size").
- Keep "Stop Frequency and Approximate Frequency Gap" calculates a harmonic grid based on the current "Stop Frequency", increasing the "Number of Points" in such a way that the frequency gap (i.e. the "Freq Step Size") remains approximately the same. This algorithm can increase the sweep time, due to the additional sweep points introduced.

The three grids can be calculated repeatedly in any order; the analyzer always starts from the original set of sweep points.

For more information, refer to [Chapter 9.7.1.4, "Harmonic Grid"](#), on page 284.

Remote command:

```
CALCulate<Chn>:TRANSform:TIME:LPASs
```

Automatic Harmonic Grid

If enabled (default) the frequency grid is automatically kept harmonic.

Remote command:

```
[SENSe<Ch>:]HARMonic:AUTO
```

DC Value

The control elements in this section define the measurement result at zero frequency and in the interpolation/extrapolation range between $f = 0$ and $f = f_{\min}$. They are enabled after a harmonic grid has been established.

Defining the low frequency sweep points

After calculating a harmonic grid, the analyzer must determine the value of the measured quantity at grid points below the analyzer's minimum frequency f_{\min} .

The following figure shows a scenario where the harmonic grid was calculated with fixed "Stop Frequency and Number of Points". The DC value and the values at the two additional red points must be extrapolated or interpolated according to the values at the measured sweep points (blue dots).

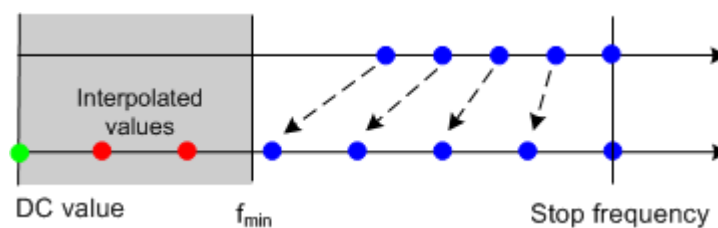

- If the properties of the DUT at $f = 0$ are sufficiently well known, then it is recommendable to enter the DC value manually ("Manual Entry").
Examples: At $f = 0$ the reflection factor of an open-ended cable is 1. It is -1 for a short-circuited cable and 0 for a cable with matched termination. If a cable with known termination is measured, enter these numbers as DC values.
- The "Extrapolate" button initiates an extrapolation of the measured trace towards $f = 0$ and overwrites the current DC value. This function can be used for a consistency check.

- "Continuous Extrapolation" initiates an extrapolation of the measured trace towards lower frequencies, so that the missing values (green and red dots) are obtained without any additional input. The extrapolation is repeated after each sweep.

After setting or extrapolating the DC value, the analyzer then calculates the remaining values (red dots) by linear interpolation of the magnitude and phase.

Remote command:

```
CALCulate<Chn>:TRANSform:TIME:LPASs:DCSParam
```

```
CALCulate<Chn>:TRANSform:TIME:LPASs:DCSParam:CONTinuous
```

```
CALCulate<Chn>:TRANSform:TIME:LPASs:DCSParam:EXTRapolate
```

```
CALCulate<Chn>:TRANSform:TIME:LPFRequency
```

10.6.6 Time Gate Tab

Defines and activates a gate in the time domain. An active time gate acts on the trace in time domain and in frequency domain representation. In time domain representation, you can use the time gate settings to eliminate unwanted responses in your signal. After switching back to the frequency domain, you will receive the frequency response of your DUT without the contribution of the unwanted responses. The time gate is independent of the frequency window used to filter the trace before transforming it to time domain.



- Time domain analysis requires option R&S ZNL-K2 / R&S ZNLE-K2. If this option is not installed, the [Time Domain Tab](#) and "Time Gate" tabs are hidden.
- Since firmware version 1.30, this option is also available for the R&S ZNLE.



Background information

Refer to [Chapter 9.7.1.5, "Time Gates"](#), on page 286.

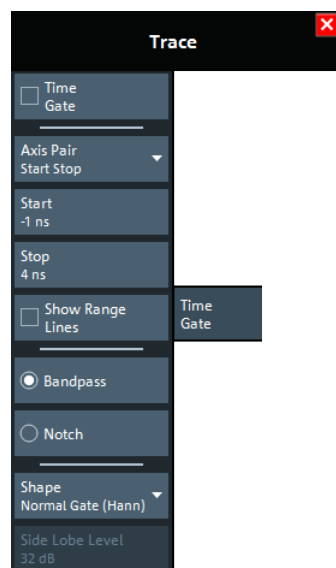

Time Gate

Enables or disables the time gate for the time domain and frequency domain traces. "Gat" is displayed in the trace list while the time gate is active.



Remote command:

```
CALCulate<Chn>:FILTer[:GATE]:TIME:STATE
```

Axis Pair

"Start Stop" lets you define the time gate via its "Start" and "Stop", "Center Span" lets you define it via its "Center" and "Span" value (in time). The analyzer generates a warning if the (resulting) time span exceeds the unambiguous range which is given by $\Delta t = 1/\Delta f$, where Δf is the "Freq Step Size". Simply reduce the time span until the warning disappears.

Remote command:

```
CALCulate<Chn>:FILTer[:GATE]:TIME:CENTer
```

```
CALCulate<Chn>:FILTer[:GATE]:TIME:SPAN
```

```
CALCulate<Chn>:FILTer[:GATE]:TIME:START
```

```
CALCulate<Chn>:FILTer[:GATE]:TIME:STOP
```

Show Range Lines

Displays or hides two red lines indicating the start and stop of the time gate in a time domain diagram.

Remote command:

```
CALCulate<Chn>:FILTer[:GATE]:TIME:SHOW
```

Bandpass / Notch

The filter type defines what happens to the data in the specific time region.

- A "Bandpass" filter passes all information in the specified time region and rejects everything else.
- A "Notch" filter rejects all information in the specified time region and passes everything else.

Remote command:

```
CALCulate<Chn>:FILTer[:GATE]:TIME[:TYPE]
```

Shape

Selects a gate shape which the R&S ZNL/ZNLE uses to filter the trace in the time domain. The drop-down list visualizes how the time gate will affect a constant function after transformation back into the frequency domain. The selected window is applied to the active trace. The two red vertical lines represent the "Start" and "Stop" values defining the size of the time gate.

See also [Chapter 9.7.1.5, "Time Gates"](#), on page 286.

Remote command:

```
CALCulate<Chn>:FILTer[:GATE]:TIME:SHAPE
```

```
CALCulate<Chn>:FILTer[:GATE]:TIME:WINDow
```

Side Lobe Level

Defines the side lobe suppression for an "Arbitrary Gate Shape (Dolph-Chebyshev)" gate. The entered value is the ratio of the power of the central lobe to the power of the first side lobe in dB.

Remote command:

```
CALCulate<Chn>:FILTer[:GATE]:TIME:DCHebyshev
```

10.6.7 Distance to Fault Tab

With option K3, the R&S ZNL/ZNLE can locate faults and discontinuities on cables and transmission lines. The measured S_{ij} -parameter trace is mathematically converted to the time domain, and represented in the distance domain. The x-axis of the DtF trace (derived from S_{ij}) shows the distance from the calibrated reference plane; faults appear as peaks above a certain level.

If option K3 is not installed on the R&S ZNL/ZNLE, the "Distance to Fault" tab is hidden.



To achieve the best distance resolution, set the sweep span as large as possible and use the [Auto Number of Points](#) to adjust the number of sweep points.

**Background information**

Refer to [Chapter 9.7.2, "Distance-to-Fault Measurements"](#), on page 288.

10.6.7.1 Controls on the Distance to Fault Tab

The controls on the "Distance to Fault" tab allow you to enable and configure a standard Distance to Fault (DtF) measurement.

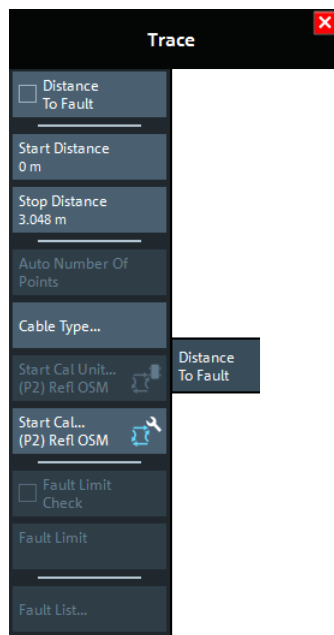

A standard DtF measurement is prepared in the order from top to bottom:

1. Enable DtF measurement, see ["Distance to Fault"](#) on page 352
2. Configure the distance window, see ["Start Distance / Stop Distance"](#) on page 353
3. Adjust the number of sweep points (and, if necessary, the frequency span), see [Auto Number of Points](#)
4. Select (or define and select) a suitable cable type, see ["Cable Type..."](#) on page 354
5. Perform a full one-port calibration at physical port 2, see ["Start Cal Unit... \(P2\) Refl OSM / Start Cal... \(P2\) Refl OSM"](#) on page 355

You should now be able to locate the faults (peaks) by examining the trace.

You can also let the firmware generate a list of faults by enabling [Fault Limit Check](#) and defining a suitable [Fault Limit](#). Use [Fault List...](#) to display (and export) the detected faults.

Distance to Fault

Activates/deactivates Distance to Fault representation for the active trace.

Note that "Distance to Fault" can only be enabled, if the active channel is configured to perform a [linear frequency sweep](#).

If the active trace is a reflection trace S_{ij} , the analyzer firmware assumes that the DUT is connected to port $p=i$. Otherwise it assumes that the DUT is connected to port $p=2$.

When activating "Distance to Fault", the analyzer firmware

- sets S_{pp} as measured quantity of the active trace
- enables additional controls on the "Distance to Fault" tab
- appends the selected cable type to the trace label (see ["Cable Type..."](#) on page 354)
- displays an additional "Distance Domain" trace info line below the channel line

Ch1	Start	5 kHz	Pwr	-10 dBm	Bw	10 kHz	Stop	3 GHz
Trc1	Start	0 m	Distance	Domain			Stop	3.048 m

Note that all info lines (channel info, trace info, "Distance Domain" trace info) allow quick access to related parameters via specific context menus:

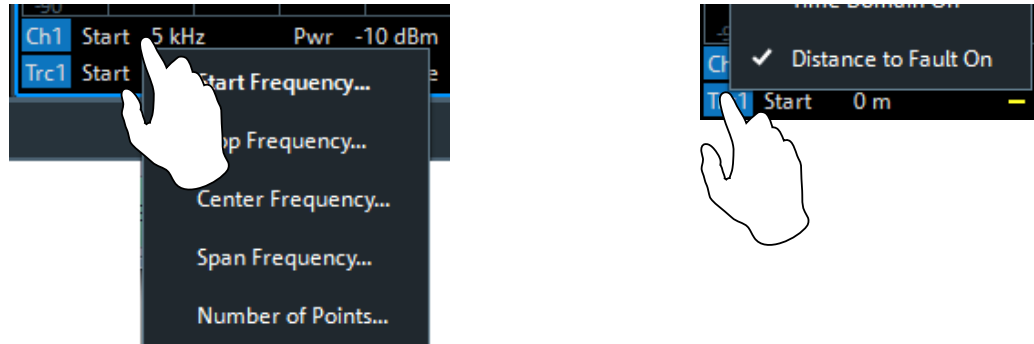

"Distance to Fault" can also be enabled/disabled via the context menu of the trace label.

Remote command:

```
CALCulate<Chn>:TRANSform:DTFault:STATe
```

Start Distance / Stop Distance

Define the distance window for the Distance to Fault measurement. "Start Distance" and "Stop Distance" correspond to the left and right edge of the diagram area and are displayed in the "Distance Domain" trace info line.

Note:

- If the "Stop Distance" is so high that for the selected **cable type** the signal reflected at "far away discontinuities" would be too small, a warning tooltip is displayed:

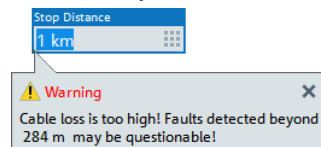

- If the "Stop Distance" exceeds the unambiguous range (for the given frequency span and number of sweep points), a warning is displayed in the instrument status bar:

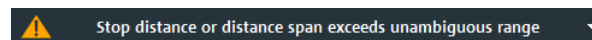

Use the **Auto Number of Points** function to adjust the number of sweep points so that the impulse response becomes unambiguous in the configured distance window.

Remote command:

```
CALCulate<Chn>:TRANSform:DTFault:START
CALCulate<Chn>:TRANSform:DTFault:STOP
CALCulate<Chn>:TRANSform:DTFault:CENTER
CALCulate<Chn>:TRANSform:DTFault:SPAN
```

Auto Number of Points

Selects the minimum number of sweep points that are required to provide an unambiguous display of fault locations for the active Distance to Fault trace.

If "Auto Number of Points" actually modifies the [Number of Points](#), a tooltip is displayed:

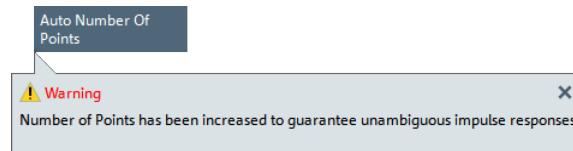

The required number of points depends on:

- the frequency span $\Delta f = f_{stop} - f_{start}$ (see ["Start Frequency / Stop Frequency / Center Frequency / Span Frequency"](#) on page 296),
- the stop distance d_{stop} (see ["Start Distance / Stop Distance"](#) on page 353), and
- the velocity factor v of the transmission line (see ["Cable Type..."](#) on page 354).

With c_0 denoting the speed of light in a vacuum, the analyzer sets the number of sweep points N to

$$N = \max \{ \lceil 2.6 \cdot d_{stop} \cdot \Delta f / (v \cdot c_0) \rceil, 201 \}$$

If the required number of sweep points would be higher than 100001 (the maximum number of sweep points of the R&S ZNL/ZNLE), the analyzer sets N to 100001 and displays the following message box:

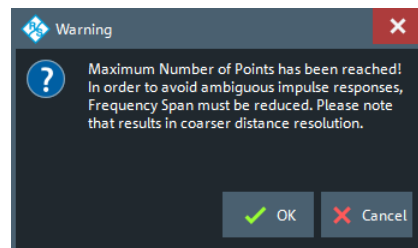

"OK" reduces the frequency span Δf to

$\Delta f = v \cdot c_0 \cdot 100001 / (2.6 \cdot d_{stop})$, which makes 100001 sweep points sufficient for unambiguous display (see the formula above). However, this reduction of the frequency span comes at the cost of coarser distance resolution.

"Cancel" (default) leaves the frequency unchanged.

Remote command:

`CALCulate<Chn>:TRANSform:DTFault:POINTs`

Cable Type...

Opens a dialog that allows to select a preconfigured cable type to be used for the calculation of the Distance to Fault traces on the active channel. A cable type is defined by its relative permittivity (or its velocity factor), and a frequency-dependent attenuation table.

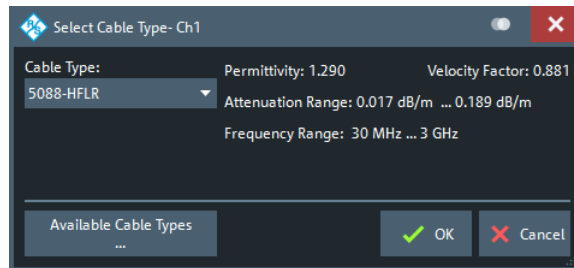

Select "Available Cable Types..." to access the list of predefined and user-defined cable types (see [Chapter 10.6.7.2, "Available Cable Types... Dialog"](#), on page 356).

Remote command:

```
CALCulate<Chn>:TRANSform:DTFault:SElect
```

Start Cal Unit... (P2) Refl OSM / Start Cal... (P2) Refl OSM

Sets up and runs the "Calibration Unit"/"Calibration Setting" wizard to perform a full one-port calibration at physical port 2 (only port 2 enabled and calibration type "Refl OSM" preselected).

The calibration serves several purposes:

- Adjust the reference plane (distance zero).
- Normalize the trace (total reflection of the signal corresponds to a 0 dB peak).
- Avoid spurious effects, e.g. peaks on the impulse response trace that are not due to a fault.

For descriptions of the calibration wizards and the corresponding remote commands, see [Calibration Unit Wizard](#) and [Calibration Setting Wizard](#).

Note: Make sure to select a sufficient number of sweep points and a suitable frequency span before you start the calibration. Otherwise the measurement can yield inaccurate results.

Use [Auto Number of Points](#) to let the firmware assist you.

Fault Limit Check

Enables/disables checking the current "Distance to Fault" trace for spikes above the given [Fault Limit](#) (red line).

The fault limit is defined relative to the 0 dB-line in the test diagram, i.e. the peak response value for total reflection after proper calibration.

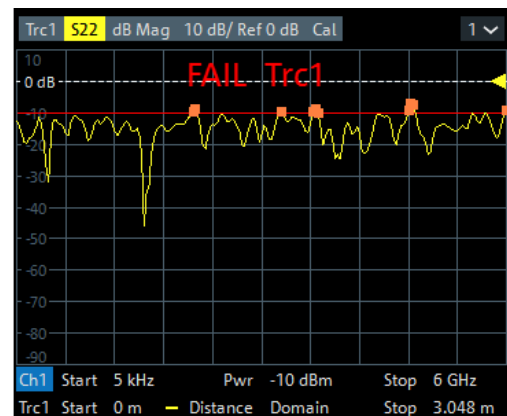
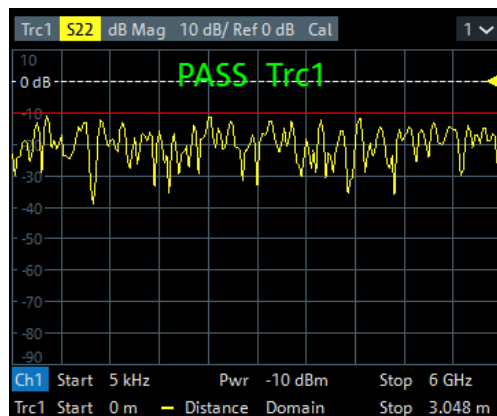

Note that the fault limit is handled like any other limit line. When "Fault Limit Check" is enabled, the current "Fault Limit" forms a new upper line segment replacing other previously defined limit lines (see [Chapter 10.9.4.2, "Define Limit Lines Dialog"](#), on page 415).

Remote command:

```
CALCulate<Chn>:TRANSform:DTFault:PEAK:STATE
```

Fault Limit

Determines the level above which peaks in the active "Distance to Fault" trace are considered as faults.

The fault limit is defined relative to the 0 dB-line in the test diagram, i.e. the peak response value for total reflection after proper calibration.

Note:

- When the "Fault Limit" is modified, the new "Fault Limit" replaces other limit lines (see [Chapter 10.9.4.2, "Define Limit Lines Dialog"](#), on page 415)
- This field is only enabled, if [Fault Limit Check](#) is active.

Remote command:

```
CALCulate<Chn>:TRANSform:DTFault:PEAK:THReshold
```

Fault List...

This button is only enabled, if [Fault Limit Check](#) is active.

It opens the [Fault List Dock Widget](#).

10.6.7.2 Available Cable Types... Dialog

The "Available Cable Types..." dialog allows you to display predefined and user-defined cable types and to add/modify/delete user-defined cable types.

Among the predefined cable types, there is an ideal air line (with a relative permittivity of 1, a corresponding velocity factor of 1, and zero attenuation) and a wide range of standard cable types.

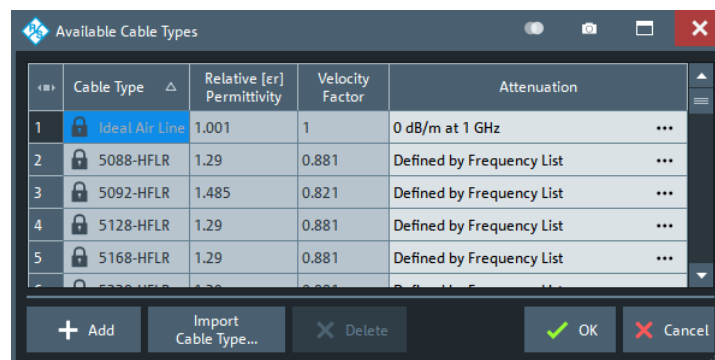

Cable types are defined by their relative permittivity ϵ_r or, equivalently, by their velocity factor $1/\sqrt{\epsilon_r}$, and a frequency-dependent attenuation table (see ["Frequency-Dependent Attenuation Table"](#) on page 357)

The velocity factor is a measure for the velocity of an electromagnetic wave in a dielectric with permittivity ϵ_r , relative to its velocity in a vacuum (velocity factor < 1). It is needed to convert the propagation times into distances.

Frequency-Dependent Attenuation Table

The "Attenuation of <Cable Type>" dialog defines the frequency dependence of the cable attenuation. The measured cables are assumed to be homogeneous so that the attenuation per length unit is constant. This means that the attenuation can be expressed in units of dB/m. Due to the skin effect and various other factors, the attenuation is frequency-dependent.



For predefined cables, the table is read-only.

Access: [Available Cable Types... Dialog](#) > "Attenuation" column > ...

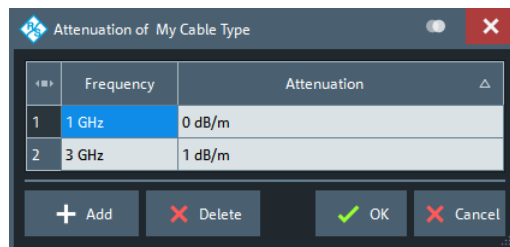

Given the specified attenuation values the R&S ZNL/ZNLE calculates the attenuation factor at the center of the channel's sweep range and corrects the impulse response trace using this attenuation factor $Attenuation(f_{center})$.

The frequency dependence can be defined in two alternative ways:

- Single reference frequency**
 If the cable attenuation is specified at a single frequency f_1 , the R&S ZNL/ZNLE calculates $Attenuation(f_{center})$ using

$$Attenuation(f_1) / Attenuation(f_{center}) = \sqrt{f_1 / f_{center}}$$
 which accounts for the impact of the skin effect.
- Frequency list**
 If the cable attenuation is specified at several frequency points, the R&S ZNL/ZNLE calculates the $Attenuation(f_{center})$ by linear interpolation. If f_{center} is below (above) the specified frequency range, then $Attenuation(f_{center})$ is linearly extrapolated from the two lowest (highest) frequency points.



It is recommended to specify the cable attenuation as accurately as possible. The correction due to the attenuation factor is proportional to the measured distance between the fault and the reference plane: The larger the distance, the larger the correction.

Add / Delete

Creates/deletes a user-defined cable type.

Remote command:

CALCulate<Chn>:TRANSform:DTFault:DEFine

CALCulate<Chn>:TRANSform:DTFault:DELete

MMEMy:LOAD:CABLE

MMEMy:STORe:CABLE

Import Cable Type

Opens the "Import Cable Type" variant of the [Open File](#) dialog that lets you select a cable type file (*.rsc) for import.

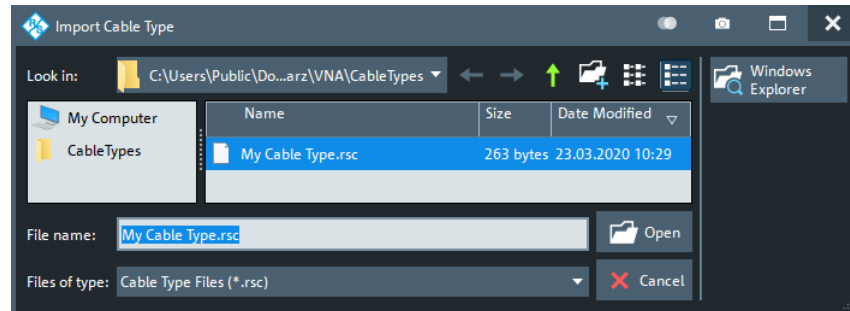

Remote command:

MMEMy:LOAD:CABLE

10.6.7.3 Fault List Dock Widget

The "Fault List" dock widget allows you to explore and save all peaks that violate the active [Fault Limit](#).

Access: [Trace] > "Distance to Fault" > "Fault List..."

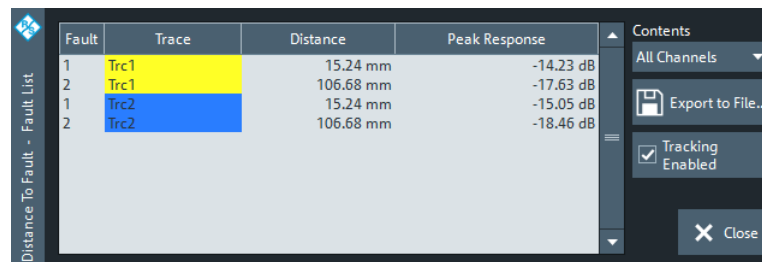

Figure 10-4: Fault List Dock Widget

Fault Table

The displays a list of all peaks that violate the active [Fault Limit](#). Unless tracking is disabled (see "[Tracking Enabled](#)" on page 359), the table is updated with every sweep.

Remote command:

CALCulate<Chn>:TRANSform:DTFault:PEAK:COUNT?

CALCulate<Chn>:TRANSform:DTFault:PEAK:DATA<FaultNo>

Contents

Allows you to filter the [Fault Table](#):

- "All Channels" (default)
The table displays the faults of all Distance to Fault traces in the current channel setup.
- "Active Channel"
The table displays the faults of all Distance to Fault traces in the active channel (if any).
- "Active Trace"
The table displays the faults of the active trace (in case it is a Distance to Fault trace) .

Export to File... ← Contents

Opens a dialog that allows to export the (filtered) content of the fault list to an ASCII file with configurable "Field Separator" and "Decimal Separator".

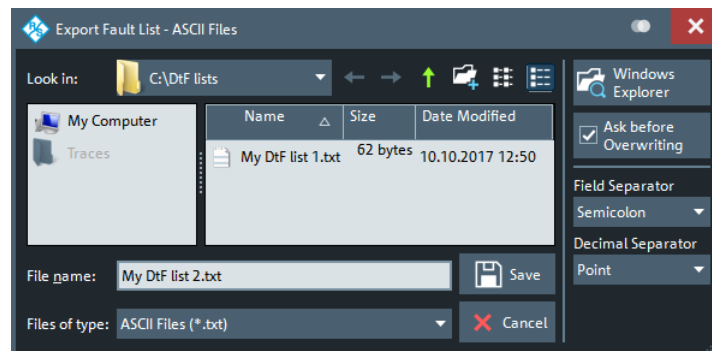

This CSV type file contains one line (terminated by CR+LF) per fault. With ";" as "Field Separator" and "." as "Decimal Separator", the fault list of [Figure 10-4](#) is exported to

```
1; Trc1; 457.2 mm; -8.56 dB
2; Trc1; 1.539 m; -9.24 dB
```

For an explanation of the possible filters, see ["Contents"](#) on page 359).

Tracking Enabled

If checked (default), the ["Fault Table"](#) on page 358 is cleared at every sweep start and populated in real time. Uncheck "Tracking Enabled" to freeze the table contents.

10.6.8 Trace Statistics Tab

Evaluates statistical and phase information of the entire trace or of a specific evaluation range.

10.6.8.1 Controls on the Trace Statistics Tab

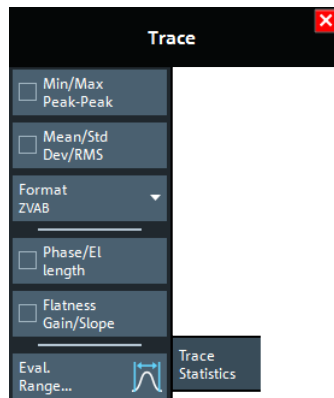

The "Evaluation Range..." button opens the "Evaluation Range" dialog (see [Chapter 10.6.8.2, "Evaluation Range Dialog"](#), on page 362).

Min/Max/Peak-Peak, Mean/Std Dev/RMS

The upper two softkeys in the "Trace Statistics" tab display or hide groups of statistical results. The values are based on all response values of the trace in the selected evaluation range ("Evaluation Range...").

Statistics (S21)	
Min	-15.1576 dB
Max	-4.2206 dB
Pk-Pk	10.9370 dB
Mean	5.9004 dB
Std Dev	1.2777 dB
Rms	5.7588 dB

Suppose that the trace in the evaluation range contains n stimulus values x_i and n corresponding response values y_i (measurement points). The statistical values are obtained as follows:

- "Min" and "Max" are the largest and the smallest of all response values y_i .
- "Pk-Pk" is the peak-to-peak value and is equal to the difference "Max"–"Min"
- "Mean" is the arithmetic mean value of all response values:

$$Mean = \frac{1}{n} \sum_{i=1}^n y_i$$

- "Std Dev" is the standard deviation of all response values:

$$Std.Dev. = \sqrt{\frac{1}{n} \sum_{i=1}^n (y_i - \frac{1}{n} \sum_{i=1}^n y_i)^2}$$

- "RMS" is the root mean square (effective value) of all response values:

$$RMS = \sqrt{\frac{1}{n} \sum_{i=1}^n |y_i|^2}$$

Note: To calculate the "Min", "Max", "Pk-Pk" and the "Std Dev" values, the analyzer uses formatted response values y_i (see trace formats). Consequently, the mean value and the standard deviation of a trace depend on the selected trace format. In contrast, the "RMS" calculation is based on linear, unformatted values. The physical unit for unformatted wave quantities is 1 Volt. The RMS value has zero phase. The selected

trace format is applied to the unformatted RMS value, which means that the RMS result of a trace does depend on the trace format.

Remote command:

```
CALCulate<Chn>:STATistics:MMPTpeak[:STATe]
CALCulate<Chn>:STATistics:MSTDdev[:STATe]
CALCulate<Chn>:STATistics:RMS[:STATe]
CALCulate<Chn>:STATistics:RESult?
CALCulate<Chn>:STATistics[:STATe]
CALCulate<Chn>:STATistics[:STATe]:AREA
```

Format

This setting determines how [Min/Max/Peak-Peak](#), [Mean/Std Dev/RMS](#) for complex-valued traces (Smith, Polar) are calculated:

- "ZVAB": the results are based on unformatted wave quantities (voltages)
- "R + jX": the results are based on the impedance values R and X
- "G + jB": the results are based on the admittance values G and B

In the two latter cases, the "RMS" value is not displayed.

Remote command:

```
CALCulate<Chn>:STATistics:FORMat
```

Phase/EI Length

Displays or hides the phase delay ("Phs Dly") and the electrical length ("EI Len") of the trace in the selected evaluation range ("Evaluation Range..."). The parameters are only available for trace formats that contain phase information, i.e. for the formats "Phase", "Unwr Phase", and the polar diagram formats "Polar", "Smith", "Inv Smith" (see [Chapter 10.8, "Format Softtool"](#), on page 395). Moreover, the sweep type must be a frequency sweep, and the evaluation range must contain at least 3 measurement points.

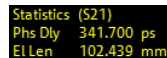

```
Statistics (S21)
Phs Dly 341.700 ps
EI Len 102.439 mm
```

The phase parameters are obtained from an approximation to the derivative of the phase in the selected evaluation range.

- "Phs Dly" is the phase delay, which is an approximation to the group delay and calculated as follows:

$$PD = -\frac{\Delta \phi_{deg}}{360^\circ \cdot \Delta f}$$

where Δf is the width of the evaluation range and $\Delta \Phi$ is the corresponding phase change. See also note on transmission and reflection parameters below.

- "EI Len" is the electrical length, which is the product of the phase delay times the speed of light in the vacuum.

If no dispersion occurs, the phase delay is equal to the group delay. For more information, refer to [Chapter 9.3.8, "Delay, Aperture, Electrical Length"](#), on page 230.

Note: To account for the propagation in both directions, delay and electrical length of a reflection parameter are only half the delay and electrical length of a transmission parameter. The formula for PD above is for transmission parameters. See the section on "Length and delay measurement" in [Chapter 9.6.1.3, "Auto Length"](#), on page 267.

Tip: The phase evaluation can cause misleading results if the evaluation range contains a 360 deg phase jump. The trace format "Unwr Phase" avoids this behavior.

Remote command:

```
CALCulate<Chn>:STATistics:EPDelay[:STATe]
CALCulate<Chn>:STATistics:RESult?
CALCulate<Chn>:STATistics[:STATe]
```

Flatness/Gain/Slope

Displays or hides trace parameters that the analyzer calculates for the selected evaluation range ("Evaluation Range...").

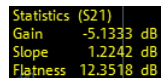

Statistics (S21)	
Gain	-5.1333 dB
Slope	1.2242 dB
Flatness	12.3518 dB

Suppose that A and B denote the trace points at the beginning and at the end of the evaluation range, respectively.

- "Gain" is the larger of the two stimulus values of points A and B.
- "Slope" is the difference of the stimulus values of point B minus point A.
- "Flatness" is a measure of the deviation of the trace in the evaluation range from linearity. The analyzer calculates the difference trace between the active trace and the straight line between points A and B. The flatness is the difference between the largest and the smallest response value of this difference trace.

Remote command:

```
CALCulate<Chn>:STATistics:SFlatness[:STATe]
CALCulate<Chn>:STATistics:RESult?
CALCulate<Chn>:STATistics[:STATe]
CALCulate<Chn>:STATistics[:STATe]:AREA
```

10.6.8.2 Evaluation Range Dialog

The "Evaluation Range" dialog defines the range for various trace evaluation operations (trace statistics, offset, loss and fixture compensation calculations). The evaluation range is a continuous interval of the sweep variable.

Access:

- [Trace] > "Trace Statistics" > "Evaluation Range..."
- [Offset Embed] > "Offset" > "Evaluation Range..."
- ...

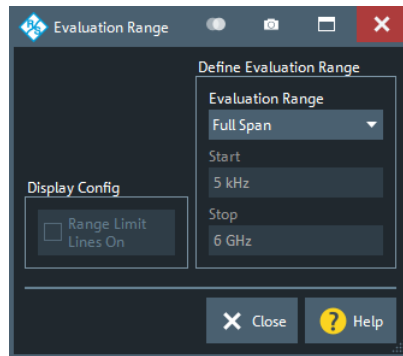

Evaluation Range

Selects a predefined evaluation range. Up to 10 different ranges are available for each channel setup. "Full Span" means that the search range is equal to the entire sweep range. The trace statistics functions consider all measurement points with stimulus values x_i between the "Start" and "Stop" value of the evaluation range:

$$\text{"Start"} \leq x_i \leq \text{"Stop"}$$

The evaluation ranges are defined similar to the marker search ranges. For more information, see [Chapter 10.11.1.2, "Search Range Dialog"](#), on page 440.

Note: A restricted evaluation range is indicated in the "Trace Statistics" info field.

```
Statistics (S21, Range 1)
Min      -14.6695 dB
Max      -4.1784 dB
Pk-Pk    10.4910 dB
```

Remote command:

```
CALCulate<Chn>:STATistics:DOMain:USER
CALCulate<Chn>:STATistics:DOMain:USER:START
CALCulate<Chn>:STATistics:DOMain:USER:STOP
```

Range Limit Lines On

Displays or hides the range limit lines in the diagram area. Range limit lines are two vertical lines at the Start and Stop values of the active evaluation range ("Range 1" to "Range 10").

Remote command:

```
CALCulate<Chn>:STATistics:DOMain:USER:SHOW
```

10.6.9 Smooth Shift Hold Tab

Provides various functions to modify the entire measured trace.



- The analyzer can export the raw complex (unformatted) data or formatted data. The unformatted data are independent of all "Smooth Shift Hold" settings; see ["Formatted Values"](#) on page 372.
- For complex traces, if marker format and trace format do not coincide, the marker values are calculated before [Smoothing](#) and [Hold](#) are applied. In this case, the displayed marker values may not behave as expected.

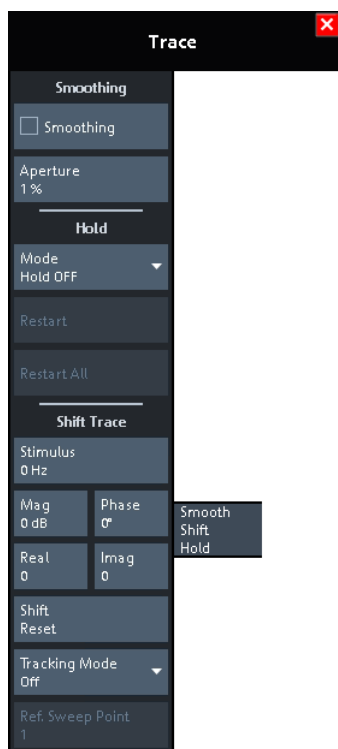

Smoothing

Activates the smoothing function for the active trace, which can be a data or a memory trace.

With smoothing active, the trace value at each sweep point is replaced by the arithmetic mean of the trace values at the sweep point itself, and at neighboring sweep points (symmetrically, to the left and to the right). The number of trace values to be averaged is defined by the [Aperture](#) and can be adjusted according to the properties of the trace.

Smoothing operates on the formatted trace and does not significantly increase the measurement time.

Tip: The sweep average is an alternative method of compensating for random effects on the trace by averaging consecutive traces. Compared to smoothing, the sweep average requires a longer measurement time but does not have the drawback of averaging out quick variations of the measured values.

See [Chapter 10.4.3, "Average Tab"](#), on page 308.

Remote command:

```
CALCulate<Chn>:SMOothing[:STATe]
```

Aperture

Defines how many trace values are averaged to smooth the trace if [Smoothing](#) is switched on.

An "Aperture" of a % means that the value at sweep point $n \in \{1, \dots, N\}$ is replaced by the arithmetic mean of the values at sweep points

$$\max \{ 1, \lfloor n - a/100 \cdot N/2 \rfloor \}, \dots, \min \{ N, \lfloor n + a/100 \cdot N/2 \rfloor \},$$

where N is the number of points of the sweep (or sweep segment for segmented sweeps).

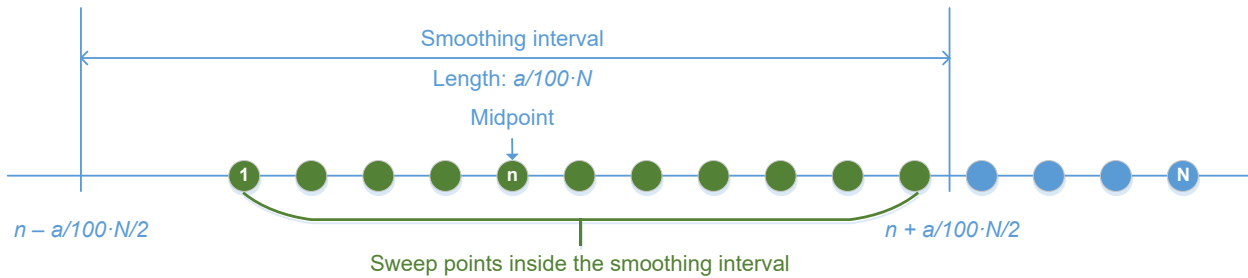

The range definition above takes border cases and rounding into account.

Tips: Finding the appropriate aperture

A large smoothing aperture enhances the smoothing effect but can hide quick variations of the measured values and thus produce misleading results.

To avoid errors, observe the following recommendations.

- Start with a small aperture and increase it only as long as you are certain that the trace is still correctly reproduced.
- Select a smoothing aperture that is small compared to the width of the observed structures (e.g. the resonance peaks of a filter). If necessary, restrict the sweep range or switch smoothing off to analyze narrow structures.

Remote command:

`CALCulate<Chn>:SMOothing:APERture`

Hold

Selects the "Max Hold" (peak hold) or "Min Hold" function for the active trace, or disables both functions ("Hold Off"). With enabled "Max Hold" or "Min Hold" function, the displayed trace shows the maximum or minimum values that the analyzer acquired since the start of the measurement. The "Max Hold" and "Min Hold" traces are real; they are based on the magnitude of the trace values (the phase values are discarded).

The "Hold" process can be restarted any time using "Restart" (current trace) or "Restart All" (all traces in the active channel setup). The "Hold" process is also restarted automatically when the channel or trace settings are changed so that the previous measurement results are no longer compatible.

Note: A memory trace is unformatted by definition. Therefore, a "to memory" operation on a "Hold" trace actually stores the last measured trace data instead of the current "Max Hold" or "Min Hold" values.

Remote command:

`CALCulate<Chn>:PHOLd`

Shift Trace

Functions for shifting the active trace in horizontal and vertical direction.

Stimulus ← Shift Trace

Shifts the active trace in horizontal direction, leaving the positions of all markers unchanged. The unit of the offset value depends on the sweep type.

Note:

A "Stimulus" shift can be used in cartesian and in complex diagrams. The visible effect depends on the diagram type:

- In cartesian diagrams, the trace is shifted relative to the markers and the x-axis.
- In complex diagrams, the trace is not affected.

Remote command:

```
DISPlay[:WINDow<Wnd>]:TRACe<WndTr>:X:OFFSet
```

Mag / Phase / Real / Imag ← Shift Trace

Modifies the active trace by adding and/or multiplying complex constants.

The trace points are modified according to the following formula:

$$M_{new} = M_{old} \cdot 10^{<Magnitude>/20 \text{ dB}} \cdot a \cdot e^{j \cdot <Phase>/180^\circ} + <Real> + j <Imag>$$

The formula and the different constants are adjusted to the different display formats of a trace:

- The "Mag" factor shifts a dB Mag trace in vertical direction, leaving the phase of a complex parameter unchanged.
- The "Phase" factor rotates a trace that is displayed in a polar diagram around the origin, leaving the magnitude unchanged.
- The "Real" value shifts a real trace in vertical direction, leaving the imaginary part unchanged.
- The "Imag" value shifts an imaginary trace in vertical direction, leaving the real part unchanged.

Tip: Shifting the trace by constant values is a simple case of trace mathematics. Use the "User Def Math" dialog to define more complicated mathematical operations (see [Chapter 10.6.4.2, "User Def Math Dialog"](#), on page 341).

Remote command:

```
DISPlay[:WINDow<Wnd>]:TRACe<WndTr>:Y:OFFSet
```

Shift Reset

Resets the static shifting, defined using [Stimulus](#) and [Mag / Phase / Real / Imag](#), respectively.

Tracking Mode/Ref Sweep Point

Allows you to take the trace value at a selected sweep point as the reference point for a dynamic shift of the active trace.

With a raw complex trace value $z = \text{Re}(z) + j \cdot \text{Im}(z) = |z| e^{j \cdot \varphi(z)}$ and a raw complex value $z_r = \text{Re}(z_r) + j \cdot \text{Im}(z_r) = |z_r| e^{j \cdot \varphi(z_r)}$ at the reference point (for the current sweep), the dynamically shifted trace value $\text{Dyn_Shift}(z)$ is calculated as follows:

"Amplitude"	$\text{Dyn_Shift}(z) = z / z_r $
"Phase"	$\text{Dyn_Shift}(z) = z e^{-j \cdot \varphi(z_r)}$
"Real"	$\text{Dyn_Shift}(z) = z - \text{Re}(z_r)$
"Imag"	$\text{Dyn_Shift}(z) = z - \text{Im}(z_r)$
"Complex"	$\text{Dyn_Shift}(z) = z - z_r$

Remote command:

n.a.

10.6.10 Infinite Averaging Tab

The controls on the "Infinite Averaging" tab allow you configure infinite averaging for the active trace.

Infinite averaging means the average at a sweep point is taken over all trace values at this sweep point since the previous restart of the averaging cycle.

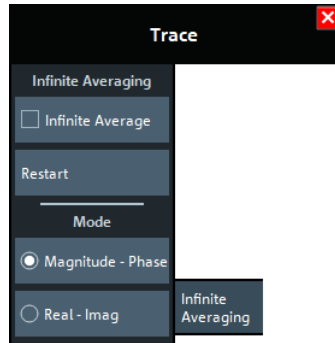

Infinite Average/Restart

"Infinite Average" enables or disables "Infinite Averaging" (default: disabled), "Restart" starts a new averaging cycle.

Remote command:

```
CALCulate<Chn>:IAverage[:STATe]
```

Mode

Selects the quantities to be averaged.

"Magnitude - Phase" Perform averaging of magnitude and phase (default) of the complex trace value.

Real - Imag Perform averaging of the real and imaginary part of the complex trace value (i.e. over the complex value itself).

Remote command:

```
CALCulate<Chn>:IAverage:MODE
```

10.6.11 Trace Data Tab

Stores one or several data or memory traces to a file or loads a memory trace from a file.



Background information

Refer to [Chapter 9.4.2, "Trace Files"](#), on page 238.

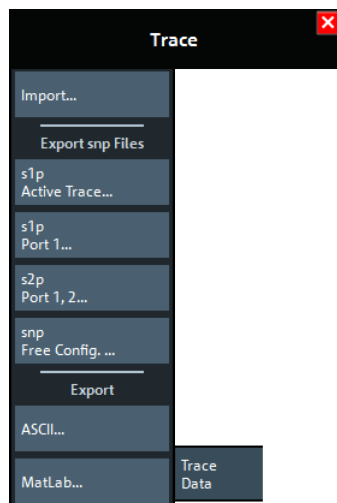

All buttons on the "Trace Data" tab serve as "openers" for related dialogs:

- "Import..." calls up a dialog to load a memory trace from a trace file; see [Chapter 10.6.11.1, "Import Complex Data Dialog"](#), on page 368.
- The buttons in the "Export snp Files" section call up a dialog to store data or memory traces to a trace file of the corresponding content and file format; see [Chapter 10.6.11.2, "Export Data - <File Type> Dialog"](#), on page 369
- "snp Free Config..." opens a dialog to define the port assignment for the created Touchstone (*.s<n>p) file. See [Chapter 10.6.11.4, "Select Ports Dialog"](#), on page 374.

10.6.11.1 Import Complex Data Dialog

The "Import Complex Data" dialog loads a memory trace from a trace file. Trace files are ASCII files with selectable file format. The loaded trace data is used to generate a memory trace which is coupled to the active data trace.

Access: [Trace] > "Trace Data" > "Import..."



Background information

Refer to [Chapter 9.4.2, "Trace Files"](#), on page 238.

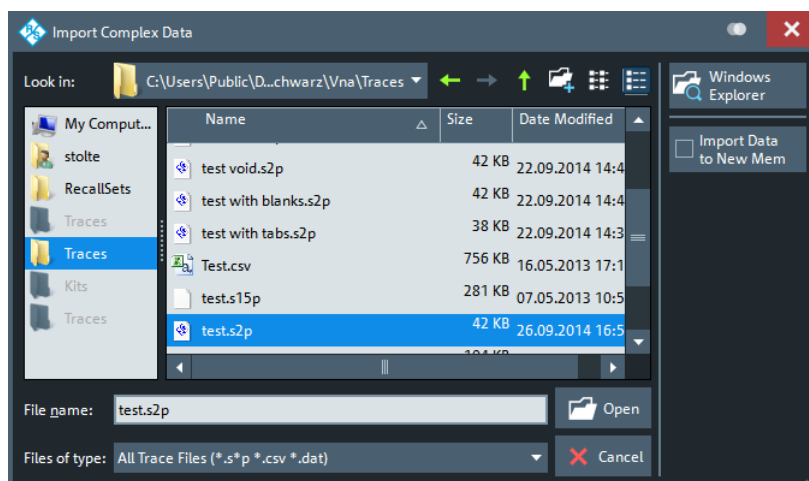

On loading data from a trace file with several traces, the analyzer displays a dialog to select one or more of the traces stored in the file (see [Chapter 10.6.11.3, "Select Parameter Dialog"](#), on page 373). E.g., for an *.s2p Touchstone file, the box offers all four 2-port S-parameters (see [Chapter 9.4.2.1, "Touchstone Files"](#), on page 239).

Coupling between the imported memory trace and the active data trace implies that the stimulus values of the imported data and of the active trace must be compatible. Compatibility means that the "Sweep Type" of the two traces must match; the position and number of the sweep points do not have to be the same.

The analyzer checks for compatibility before importing data. The "Select Parameter" box remains empty if the selected file contains no compatible data.

"Import Complex Data" is a standard "Open File" dialog with an additional button.

Import Data to New Mem

Specifies whether the loaded data overwrite an existing memory trace, if available (box unchecked), or whether they are used to generate a new memory trace (box checked). If the box is unchecked and the active trace is a memory trace, then this memory trace will be overwritten. If the box is unchecked and the active trace is a data trace, then the data trace's last created memory trace will be overwritten (or a new memory trace will be created, in case there was previously no memory trace assigned to this data trace).

Remote command:

[MMEMory:LOAD:TRACe](#)

10.6.11.2 Export Data - <File Type> Dialog

The "Export Data - <File Type>" dialog stores data or memory traces to a trace file. Trace files are ASCII files with selectable file format.

Access:

- [Trace] > "Trace Data" > "Export snp Files" – ...
- [Trace] > "Trace Data" > "Export" – ...

Data export can serve many purposes, e.g.:

- To process and evaluate measurement data in an external application.
- To store measurement data and reimport it in a future measurement session.



Background information

Refer to the following sections:

- [Chapter 9.4.2, "Trace Files"](#), on page 238.
- [Chapter 9.4.2.3, "Finding the Best File Format"](#), on page 246

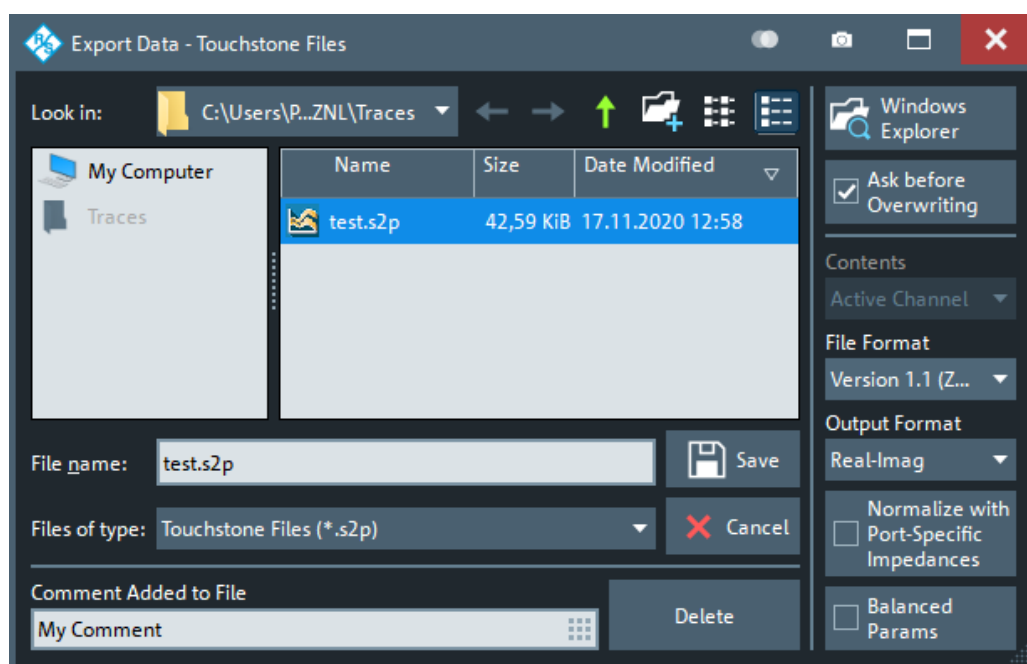

Figure 10-5: Touchstone file export

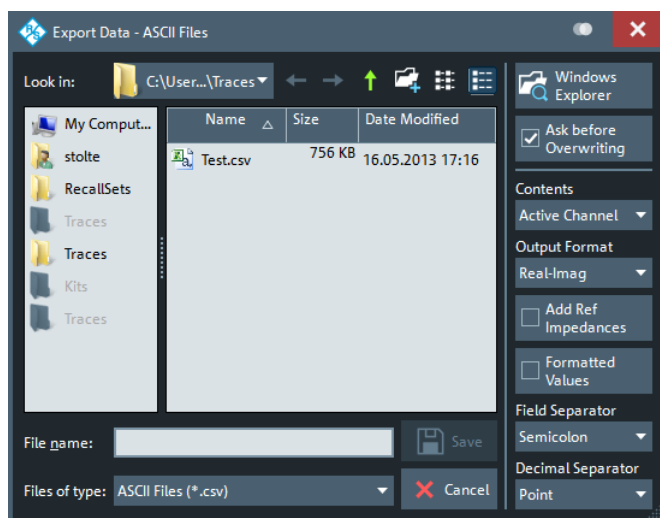

Figure 10-6: ASCII Trace files export

The "Export Data - <File Type>" dialog is a standard "Save File" dialog with several additional buttons to specify the export options. Many options depend on the selected export file format ("Files of type"). The displayed controls change accordingly.

The export options are remembered when the dialog is closed.

Ask Before Overwriting

Activates a message box to be displayed before an older trace file with the same file name and directory is overwritten.

Contents

For ASCII (*.csv) and Matlab (*.dat) export, you can include the active trace, all traces of the active channel (including memory traces), or all traces in all channels.

For Touchstone file export, it is possible to export the traces of the active channel or of all channels. Consider "[Conditions for Touchstone File Export](#)" on page 244.

In both cases, the R&S ZNL/ZNLE creates one file per channel.

File Format

Selects the Touchstone file format to be generated. See [Chapter 9.4.2.1, "Touchstone Files"](#), on page 239.

Remote command:

n.a.

Output Format

Selects the format of the exported raw, complex measurement values. The exported values can be represented by the real and imaginary parts, the linear magnitude and phase, or dB magnitude and phase; see also "[Formatted Values](#)" on page 372.

Export of [Formatted Values](#) is not available for Touchstone files.

Normalize with Port-Specific Impedances

For Touchstone file export only. If checked, the firmware renormalizes the exported S-parameters according to the port-specific reference impedances instead of a common target impedance of 50 Ω (see ["Renormalization of S-Parameters"](#) on page 245).

Note however, that during import the firmware always assumes a common reference impedance of 50 Ω .

Balanced Params

For Touchstone file export only: activates/deactivates the export of balanced (and mixed-mode) S-parameters.

Note:

- Please consider ["Conditions for Touchstone File Export"](#) on page 244. In particular: if only one port of a balanced port is selected, then the export fails.
- In contrast to single-ended S-parameters, balanced S-parameters are always normalized.

Remote command:

`MMEMory:STORe:TRACe:OPTion:BALanced`

Decimal Places

Opens a dialog that allows you to specify the number of decimal places for stimulus and data values in all supported trace data files (Touchstone, ASCII, MatLab).

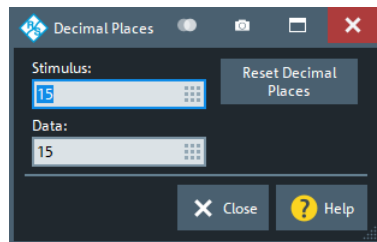

The allowed range is 1 (minimum precision) to 15 (maximum precision). "Reset Decimal Places" resets these numbers to their respective defaults, which is 15 in both cases.

Note: In the current implementation of the Touchstone file export, only the "Version 1.1 (ZNX)" [File Format](#) file format supports independent settings for stimulus and data values. For the "Version 1.1" and "Version 2.0" formats the "Data" number of digits is used for both stimulus and data values.

Add Ref Impedances

For ASCII (*.csv) or Matlab (*.dat) files only: Includes the reference impedances Z_0 for all analyzer ports in the file header.

Formatted Values

For ASCII (*.csv) or Matlab (*.dat) files only: Selects the format for the exported trace data.

- **Check box cleared (off):** Export the raw complex (unformatted) measurement values, represented by the real and imaginary parts, the linear magnitude and phase, or dB magnitude and phase.

The exported complex trace values are the values at the beginning of the trace data flow. None of the following stages (trace mathematics, shift, time domain gate, trace formatting and smoothing) affects the exported data. "Save" writes the raw stimulus values (frequency/power/time, according to the sweep type) and the raw, complex measurement points to a file.

Export of complex data is available for all trace file types.

- **Check box selected (on):** Export the values as they are displayed in the diagram, e.g. export the dB magnitude, if trace format "dB Mag" is selected. The trace file does not necessarily contain the full (complex) information about the trace.

For trace formats involving Cartesian diagrams ("dB Mag", "Real", "Imag"...), the stimulus value and a single real response value is exported. For circular diagrams, both the real and imaginary part of the response value is exported.

The trace values are the fully processed values as they appear in the diagram area. They correspond to the results in the marker info field. All possible stages of the trace data flow (e.g. trace formats, trace mathematics, time domain transform, shift, smoothing) are considered. Some trace functions (e.g. time scale, shift stimulus) also affect the stimulus values.

Export of formatted data is not available for Touchstone files.

Field Separator

For ASCII (*.csv) and Matlab (*.dat) export only: defines the separator the analyzer uses to separate different numbers in each line of the file.

Decimal Separator

For ASCII (*.csv) files only: Selects either the "Point" or the "Comma" (if needed to process the exported data with an external application) as a separator for decimal numbers.

Save

Stores the trace data, according to the selected options.

Tip: Note the conditions described in ["Conditions for Touchstone File Export"](#) on page 244.

Remote command:

`MMEMoRY:STORe:TRACe:PORTs`

`MMEMoRY:STORe:TRACe`

`MMEMoRY:STORe:TRACe:CHANnel`

Comment Added to File

Defines a comment to be added to the exported trace data file.

If empty (←"Delete"), no comment is added.

Remote command:

n.a.

10.6.11.3 Select Parameter Dialog

The "Select Parameter" dialog provides a selection of measurement results (e.g. S-parameters) or traces, e.g. for trace import, import of power correction coefficients, limit line import.

Access: The dialog may be called from several dialogs, for example on pressing "Open" in the [Import Complex Data Dialog](#).

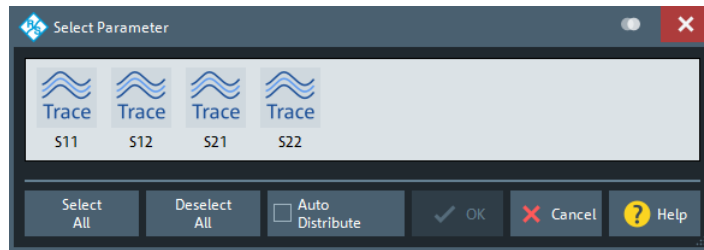

Select All / Deselect All

During trace data import, selects/deselects all traces contained in the opened trace file.

Auto Distribute

Available for trace data import only.

If checked, a selected trace S_{ij} is imported as a memory trace for all data traces in the current channel setup that are measuring S_{ij} .

Remote command:

`MMEMoRY:LOAD:TRACe:AUTO`

10.6.11.4 Select Ports Dialog

The "Select Ports" dialog defines the port assignment for the created Touchstone (*.s<n>p) file.

Access: [Trace] > "Trace Data" > "snp Free Config..."



Touchstone files and file export

Note the conditions described in ["Conditions for Touchstone File Export"](#) on page 244.

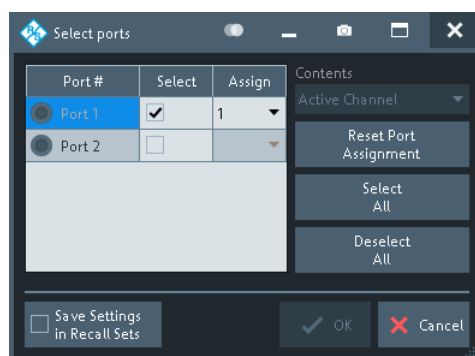



Checks and Messages in the Dialog

After each port or channel selection, the R&S ZNL/ZNLE checks the channel data for compatibility with the trace export conditions. If data from "All Channels" are exported, every channel must contain a compatible set of traces; see "[Conditions for Touchstone File Export](#)" on page 244.

The "OK" button is available only if no error message is displayed in the dialog.

Select / Select All / Deselect All

Selects the ports to be considered for the S-parameter export.

Example: With ports 1 and 2 selected, S-parameters S_{11} , S_{12} , S_{21} and S_{22} are exported.

Remote command:

`MMEMory:STORe:TRACe:PORTs`

Assign

Selects the port number assignment in the created `*.s<n>p` file. By default, analyzer and `*.s<n>p` port numbers are identical. You can interchange the port assignment to change the order of the S-parameters in the created Touchstone file. Each of the analyzer port numbers must be assigned to one `*.s<n>p` port number.

Active Channel / All Channels

Selects data export for the active channel or for all channels.

Reset Port Assignments

Restores the identity between original and assigned port number.

Save Settings in Channel Setup

The "Select Ports" dialog preserves the selected and assigned port numbers. By default (unchecked), these settings are global, i.e. they are identical for each channel setup and are not affected by a [Preset]. However you can also choose to preserve specific settings for the current channel setup (checked).

Note however that the settings are not persisted unless the "Select Ports" dialog is closed using "OK".

10.7 Meas Softtool

The "Meas" softtool allows you to select the quantities to be measured and displayed.

Access: [Meas]



Background information

For a detailed description of all measurement results of the R&S ZNL/ZNLE, refer to [Chapter 9.3, "Measurement Results"](#), on page 217.



Efficient trace handling

To select a result and display it as a trace, you can simply drag and drop the corresponding button into a diagram area.

Port activation on demand

If a requested result involves disabled ports, but could be calculated if those ports were configured as single-ended ports with "logical port number = physical port number", then the required logical port configuration is performed automatically.

For example, with P1 assigned to L1 and P2 disabled, S21 could be measured if P2 would be assigned to L2.

10.7.1 S-Params Tab

Selects S-parameters as measured quantities. S-parameters are the basic measured quantities of a network analyzer. They describe how the DUT modifies a signal that is transmitted or reflected in forward or reverse direction. S-parameters (and derived quantities such as Y- and Z-parameters) fully characterize a linear DUT.



Background information

Refer to [Chapter 9.3.1, "S-Parameters"](#), on page 218.

10.7.1.1 Controls on the S-Params Tab

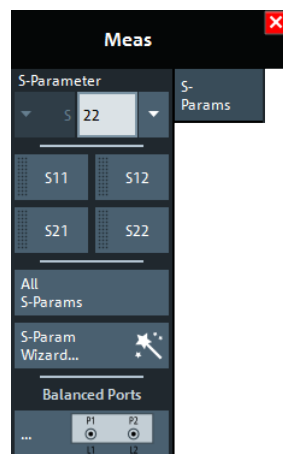

S-Parameter (selector)

Selects an [S-parameters](#) as a measured quantity for the active trace.

Single-ended (unbalanced) S-parameters are referred to as S<out><in>, where <out> and <in> denote the output and input **logical** port numbers, respectively.

In presence of balanced ports, standard S-parameters are defined in the form $S_{\langle m_out \rangle \langle m_in \rangle \langle out \rangle \langle in \rangle}$, where output mode $\langle m_out \rangle$ and input mode $\langle m_in \rangle$ can be one of:

- d (differential, balanced)
- c (common, balanced)
- s (single-ended, unbalanced)

It is also possible to display "raw" single-ended S-parameters within the same channel: after setting the S-Parameter type to "S" any pair of (used) **physical** ports can be selected.

Remote command:

```
CALCulate<Ch>:PARAmeter:MEASure
CALCulate<Ch>:PARAmeter:MEASure:SENDEd
CALCulate<Ch>:PARAmeter:SDEFine
CALCulate<Ch>:PARAmeter:SDEFine:SENDEd
```

S<out><in>

Selects one of the four elements of the standard 2-port **S-parameters** as a measured quantity for the active trace.

Remote command:

```
CALCulate<Ch>:PARAmeter:MEASure "<Trace_Name>", "S11" | "S12" |
"S21" | "S22"
CALCulate<Ch>:PARAmeter:SDEFine "<Trace_Name>", "S11" | "S12" |
"S21" | "S22"
```

All S-Params

Creates 4 diagrams and displays the full set of **S-Parameters**, one in each diagram. The diagrams are arranged as an (2 x 2) matrix.

The reflection coefficients S_{ii} appear in the diagrams on the main diagonal, the transmission coefficients S_{ij} ($i \neq j$) occupy the other diagrams. By default, reflection coefficients are displayed in Smith diagrams; transmission coefficients in Cartesian diagrams "dB Mag" scale.

See also [Format Softtool](#).

Remote command:

```
CALCulate<Ch>:PARAmeter:SDEFine
CALCulate<Ch>:PARAmeter:DEFine:SGRoup
```

S-Param Wizard...

Opens a dialog that guides you through the setup of a standard multi-port S-parameter measurement in a frequency sweep. See [Chapter 10.7.1.2, "S-Parameter Wizard"](#), on page 378.

Balanced Ports...

Opens a dialog that allows you to enable/disable physical ports and to define logical ports (balanced or unbalanced) in the active channel. See [Chapter 10.7.1.3, "Balanced Ports Dialog"](#), on page 379.

Note: If the "Fixture Simulator" is disabled for the related channel (see ["Fixture Simulator"](#) on page 485), the "Balanced Ports..." button is inactive (grayed out).

10.7.1.2 S-Parameter Wizard

The "S-Parameter Wizard" guides you through the setup of a standard two-port S-parameter measurement in a frequency sweep.

Access: [Meas] > "S-Params" > "S-Param Wizard..."

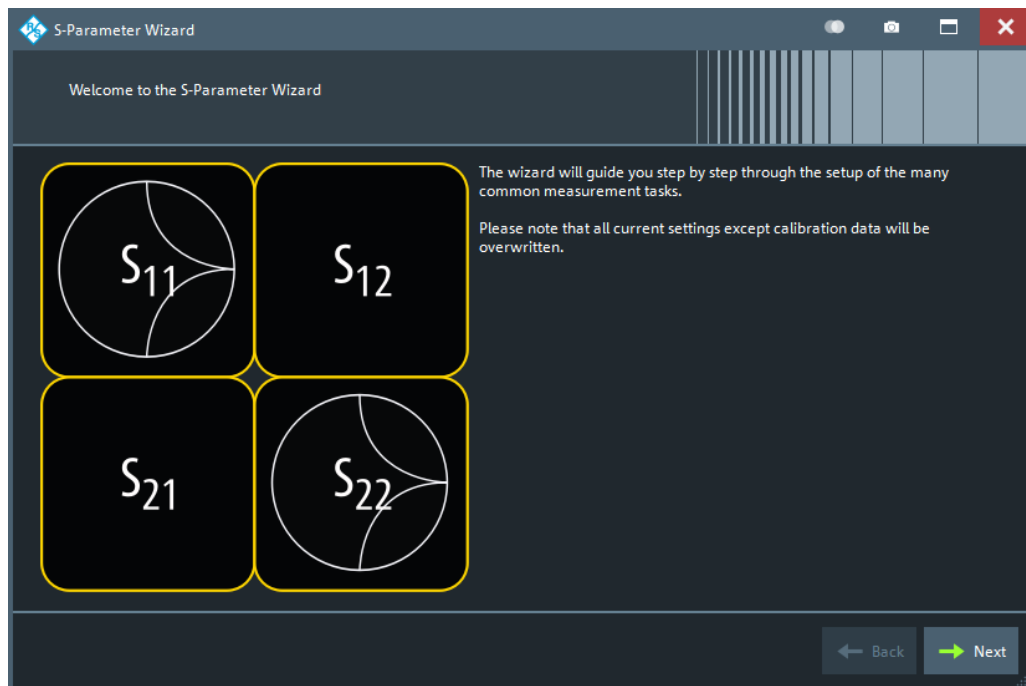

The wizard proceeds in the following steps:

1. **Select the test setup.**
Choose the port setup of the analyzer according to the port configuration of your DUT. Then connect the DUT to the selected analyzer ports.
This step corresponds to the "Predefined Config" tab of the "Balanced Ports" dialog; see "[Predefined Config Tab](#)" on page 380.
2. **Define the port impedances.**
Assign reference impedances to all physical and balanced test ports selected in the previous step. The reference impedances can be complex.
This step corresponds to the "Reference Impedance" tab of the "Balanced Ports" dialog; see "[Reference Impedance Tab](#)" on page 381.
Tip: The default reference impedance of the physical analyzer ports is $Z_0 = 50 \Omega$. The default reference impedances for balanced ports are derived hereof. You do not need to change this value unless you want to renormalize the port impedances; see [Chapter 9.3.2, "Reference Impedances"](#), on page 219.
3. **Select the measurement parameters and the diagram areas.**
Depending on the test setup selected in [step 1](#), the wizard offers different sets of S-parameters. Each S-parameter trace is displayed in a separate diagram. For trans-

mission parameters, the wizard always selects dB magnitude format. For reflection parameters, you can select between Smith or dB magnitude format.

Tip: You can always use the "Back" button to return to previous wizard steps and modify your settings.

4. **Select the sweep settings.**

Lets you choose the [frequency range](#), and the [number of points](#) per sweep.

5. **Select the measurement bandwidth and source power.**

Choose a typical [measurement bandwidth](#) and one of three typical [source power](#) values. A smaller measurement bandwidth increases the dynamic range but slows down the measurement. If necessary, select a smaller source power to protect the input port of the analyzer.

Note:

The predefined bandwidths and source powers have been selected according to the following criteria:

- The large measurement bandwidth ("Fast Sweep") ensures that the noise of an S_{21} trace at minimum source power and 0 dB attenuation is smaller than 0.1 dB.
- The default source power for a passive DUT ensures that the analyzer receiver is in its linear range (no compression) if a passive DUT with 0 dB attenuation is measured. The default source powers for active DUTs ensure no compression if an active DUT with 20 dB or 40 dB gain is measured.
If the actual gain of the DUT is higher than 50 dB, then the default source power of -40 dB is still too high. It must be changed after finishing the wizard.

6. **Perform a calibration (optional).**

Allows you to perform a calibration. The "S-Parameter Wizard" proposes a full 2-port calibration of the test ports selected in [step 1](#). Automatic calibration is also possible (if a calibration unit is available).

Tip:

You can skip the calibration step (select "Finish now without Calibration") if one of the following applies:

- A valid calibration is already assigned to the active channel
- You want to apply a valid calibration stored in the cal pool.
- You do not want to use a calibration, e.g. because the factory calibration is accurate enough for your measurement.



Instrument reset

To obtain a predictable result, the measurement wizard has to reset all settings except the current calibration data. Store your channel setup if you do not want to lose the current configuration.

10.7.1.3 Balanced Ports Dialog

The "Balanced Ports" dialog allows you to enable/disable physical ports and to define logical ports (balanced or unbalanced) in the active channel.

Access: [Meas] > "S-Params" > "Balanced Ports..."



Background information

Refer to the following sections:

- [Chapter 9.3.6, "Unbalance-Balance Conversion"](#), on page 227
- [Chapter 9.3.6.1, "Balanced Port Configurations"](#), on page 228
- [Chapter 9.3.2, "Reference Impedances"](#), on page 219

Predefined Config Tab

The "Predefined Config" tab of the "Balanced Ports" dialog provides the most commonly used logical port configurations of the analyzer.

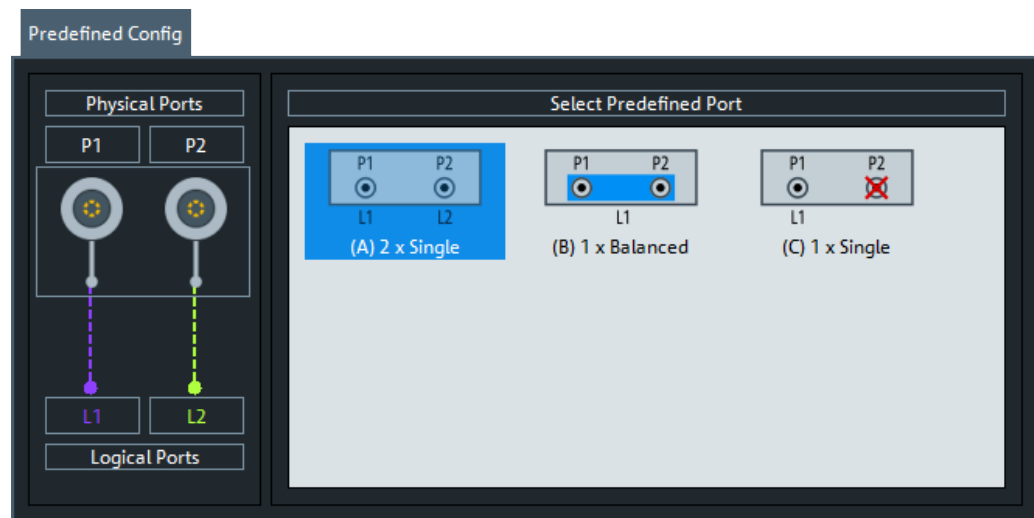

The port configurations are arranged in the list to the right. The resulting port assignment is shown on the left-hand side of the "Predefined Config" tab.

- For a single-ended port, the diagram shows a single line between the physical test port and the logical port.
- For a balanced port, two physical ports are combined to form a single logical port.
- For unused ports, the physical port is crossed out; no logical port number is assigned.

Select Predefined Port

Allows you to select from a set of predefined logical port configurations.

Remote command:

```
SOURce<Ch>:LPORt<LogPt>
```

```
SOURce<Ch>:LPORt<LogPt>:CLEAr
```

User Config Tab

The "User Config" tab of the "Balanced Ports" dialog defines a new balanced port configuration.

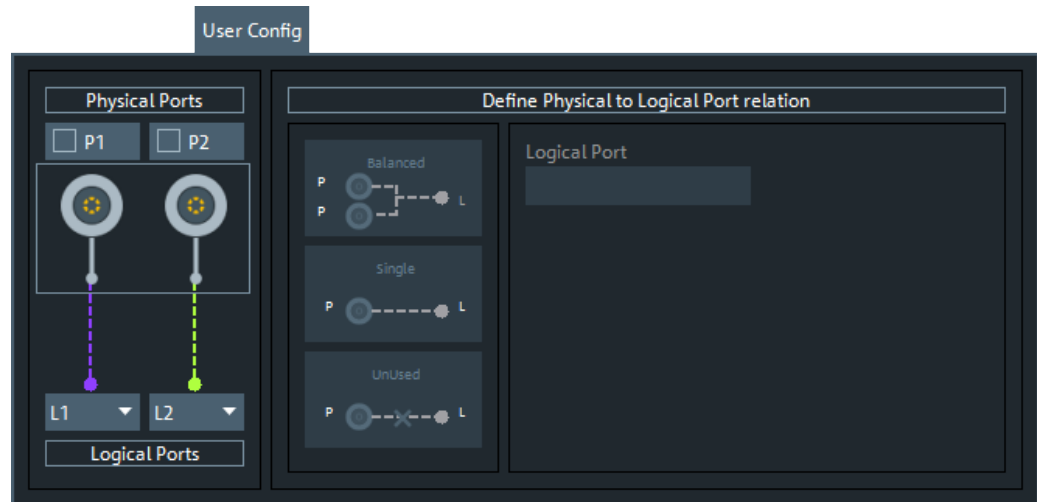

Physical Ports / Logical Ports

Allows you to renumber logical ports.

Remote command:

```
SOURce<Ch>:LPORt<LogPt>
```

```
SOURce<Ch>:LPORt<LogPt>:CLEAr
```

Define Physical to Logical Port Relation

- To define a balanced port, select two physical ports and tap "Balanced".
- To dissolve a balanced port, select it and tap "Single".
- To exclude a physical port from the measurement, select the port and tap "Unused".

Furthermore, provides functions for renumbering the logical ports.

Remote command:

```
SOURce<Ch>:LPORt<LogPt>
```

```
SOURce<Ch>:LPORt<LogPt>:CLEAr
```

Reference Impedance Tab

The "Reference Impedance" tab of the "Balanced Ports" dialog allows you to define (or redefine) the impedances of the logical ports.



Background information

Refer to [Chapter 9.3.2, "Reference Impedances"](#), on page 219.

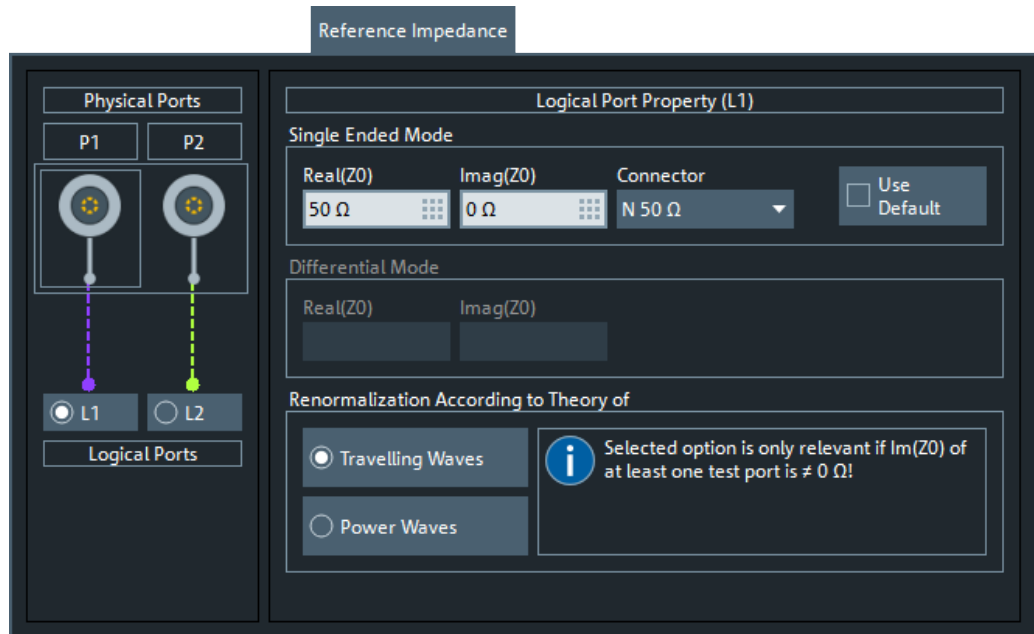

By default, the reference impedance of a physical port is set to the reference impedance of the connector type assigned to the port. However, it can be defined as an arbitrary complex value (renormalization of port impedances). By changing the reference impedance, it is possible to convert the measured values at 50 Ω (75 Ω) into values at arbitrary port impedances.

For balanced ports, it is possible to define separate complex reference impedances for differential and for common mode.

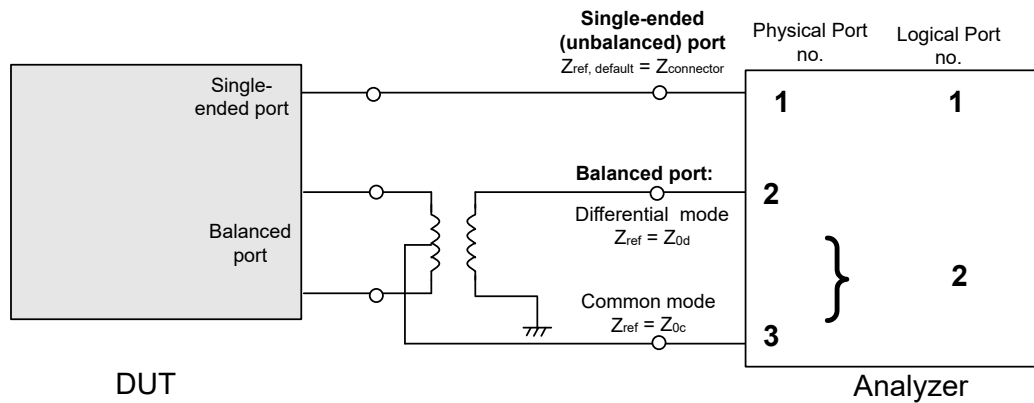

Single Ended Mode / Common Mode / Differential Mode

Defines arbitrary reference impedances.

"Single Ended Mode" is available for single-ended logical ports only, "Common Mode" and "Differential Mode" impedances for balanced ports only.

The default values for the balanced port reference impedances are derived from the (real) default reference impedance $Z_0 = 50 \Omega$ of the (single-ended) physical analyzer ports:

- The default value for the differential mode is $Z_{0d} = 100 \Omega = 2 \cdot Z_0$.

- The default value for the common mode is $Z_{0c} = 25 \Omega = Z_0/2$.

Remote command:

```
[SENSe<Ch>:] PORT<PhyPt>:ZREference
[SENSe<Ch>:] LPORT<LogPt>:ZCOMmon
[SENSe<Ch>:] LPORT<LogPt>:ZDIFferent
```

Connector

Allows you to specify the connector type of the related physical port.

Remote command:

```
[SENSe<Ch>:] CORRection:COLLect:CONNection<PhyPt>
```

Use Default

Allows you to toggle between default and renormalized port impedance (or impedances) for the selected logical port and connector type.

Remote command:

```
[SENSe<Ch>:] LPORT<LogPt>:ZDEFault[:STATe]
```

Renormalization According to Theory of

Selects the waveguide circuit theory for renormalization. The conversion formulas of these theories only differ if the reference impedance of at least one test port has a non-zero imaginary part.

Refer to [Chapter 9.3.2, "Reference Impedances"](#), on page 219.

Remote command:

```
CALCulate<Chn>:TRANSform:IMPedance:RNORmal
```

10.7.2 Ratios Tab

Selects ratios of wave quantities as measured quantities.



Background information

Refer to [Chapter 9.3.5, "Wave Quantities and Ratios"](#), on page 225.

10.7.2.1 Controls on the Ratios Tab

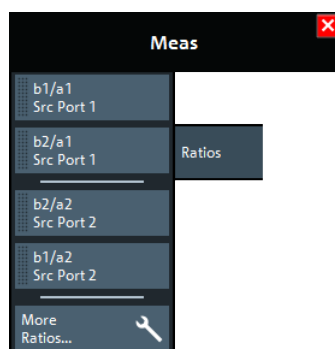

The "More Ratios..." button opens the [More Ratios](#) dialog which allows to select an arbitrary [ratio](#) of wave quantities.

b<i>/ a<j> Source Port <j>

Selects predefined complex [ratios](#) of the standard 2-port wave quantities a_1 , a_2 , b_1 , and b_2 .

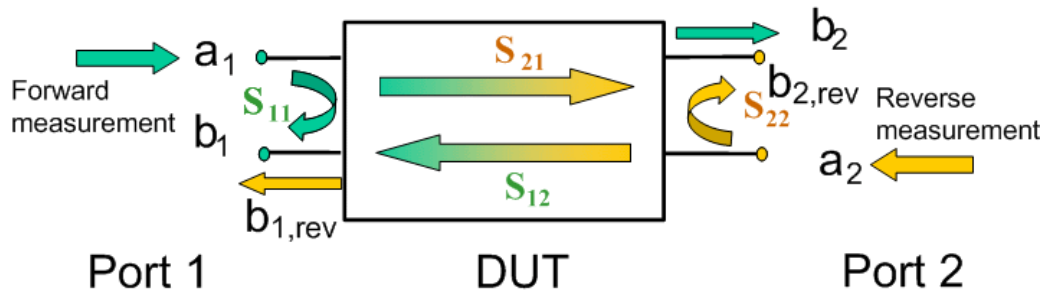

The predefined wave quantities can all be obtained with the same test setup, where a 2-port DUT is connected between the analyzer ports 1 and 2. The stimulus signal is provided by the analyzer port 1 or 2 ("Source Port").

The predefined wave quantities correspond to the 2-port S-parameters:

- "b1/a1 Source Port 1" is the ratio of the wave quantities b_1 and a_1 , measured at port 1. This ratio corresponds to the S-parameter S_{11} (input reflection coefficient).
- "b2/a1 Source Port 1" is the ratio of the wave quantities b_2 and a_1 and corresponds to the S-parameter S_{21} (forward transmission coefficient).
- "b2/a2 Source Port 2" is the ratio of the wave quantities b_2 and a_2 , measured at port 2. This ratio corresponds to the S-parameter S_{22} (output reflection coefficient).
- "b1/a2 Source Port 2" is the ratio of the wave quantities b_1 and a_2 and corresponds to the S-parameter S_{12} (reverse transmission coefficient).

The analyzer can also measure arbitrary ratios for other source ports; see [Chapter 10.7.2.2, "More Ratios Dialog"](#), on page 384.

Tip: In the trace list, the source port is indicated in brackets. "b2/a1(P1)" denotes the ratio b_2/a_1 with source port 1.

Remote command:

```
CALCulate<Ch>:PARAMeter:MEASure "<Trace_Name>", "B2/A1" | ...
CALCulate<Ch>:PARAMeter:SDEFine "<Trace_Name>", "B2/A1" | ...
```

10.7.2.2 More Ratios Dialog

The More Ratios dialog allows you to select arbitrary ratios between wave quantities b_i , a_j as measured quantity. The ratios can be calculated with arbitrary source port and different detector settings.

Access: [Meas] > "Ratios" > "More Ratios..."



Background information

Refer to the following sections:

- [Chapter 9.3.5.1, "Wave Quantities"](#), on page 226
- [Chapter 9.3.5.2, "Ratios"](#), on page 226

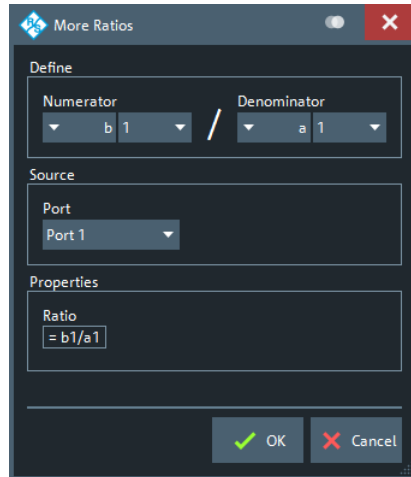

The notation for ratios follows the usual scheme of the vector network analyzer:

- The a-waves are the outgoing/transmitted waves at the analyzer's test ports.
- The b-waves are the incoming/measured waves.
- The source port for the stimulus signal must be specified in addition.
- The port number range covers all test ports of the analyzer.

Numerator

Selects the type (left pull-down list) and the port number assignment (right pull-down list) of the wave that forms the numerator of the [ratio](#).

Remote command:

```
CALCulate<Ch>:PARAmeter:MEASure "<Trace_Name>", "B2/A1" | ...
CALCulate<Ch>:PARAmeter:SDEFine "<Trace_Name>", "B2/A1" | ...
```

Denominator

Selects the type (left pull-down list) and the port number assignment (right pull-down list) of the wave that forms the denominator of the [ratio](#).

Remote command:

```
CALCulate<Ch>:PARAmeter:MEASure "<Trace_Name>", "B2/A1" | ...
CALCulate<Ch>:PARAmeter:SDEFine "<Trace_Name>", "B2/A1" | ...
```

Port

Selects the source port for the stimulus signal ("Port 1" or "Port 2").

Remote command:

```
CALCulate<Ch>:PARAmeter:MEASure "<Trace_Name>", "<Ratio>"
CALCulate<Ch>:PARAmeter:SDEFine "<Trace_Name>", "<Ratio>"
```

10.7.3 Wave Tab

Selects wave quantities as measured quantities.



Background information

Refer to [Chapter 9.3.5, "Wave Quantities and Ratios"](#), on page 225.

10.7.3.1 Controls on the Wave Tab

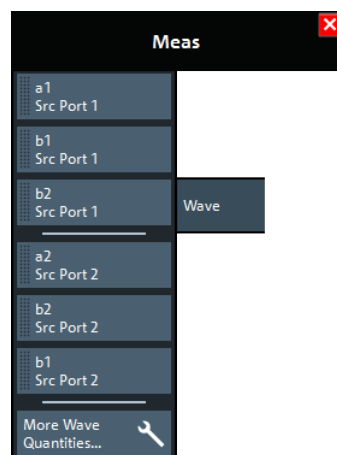

The "More Wave Quantities..." button opens the [More Wave Quantities](#) dialog which allows to select an arbitrary [wave quantity](#), e.g. for different source ports or higher port numbers.

a<i> Source Port <i>, **b<j>** Source Port <i>

Selects one of the standard 2-port [wave quantities](#) a_i, b_j for different source ports.

The predefined wave quantities are obtained with different source ports. "a1 Source Port 1", "b1 Source Port 1" and "b1 Source Port 2" are measured at Port 1 of the analyzer. "a2 Source Port 2, b2 Source Port 1" and "b2 Source Port 2" are measured at Port 2 of the analyzer.

- "a1 Source Port 1" is the wave transmitted at physical port 1. In a standard S-parameter measurement, this wave is fed to the input port (port 1) of the DUT (forward measurement).
- "b1 Source Port 1" is the wave received at physical port 1. In a standard S-parameter measurement, this wave is reflected at port 1 of the DUT (forward measurement).
- "b2 Source Port 1" is the wave received at physical port 2. In a standard S-parameter measurement, this wave is transmitted at port 2 of the DUT (forward measurement).
- "a2 Source Port 2" is the wave transmitted at physical port 2. In a standard S-parameter measurement, this wave is fed to the output port (port 2) of the DUT (reverse measurement).
- "b1 Source Port 2" is the wave received at physical port 1. In a standard S-parameter measurement, this wave is transmitted at port 2 of the DUT (reverse measurement).

- "b2 Source Port 2" is the wave received at physical port 2. In a standard S-parameter measurement, this wave is fed to the output port (port 2) of the DUT (reverse measurement).

Tip: In the trace list, the source port is indicated in brackets. For example, "a1(P1)" denotes the wave a_1 with source port 1.

The analyzer can also measure arbitrary wave quantities for other source ports; see [Chapter 10.7.3.2, "More Wave Quantities Dialog"](#), on page 387.

Remote command:

```
CALCulate<Ch>:PARAmeter:MEASure "<Trace_Name>", "A1" | ...
CALCulate<Ch>:PARAmeter:SDEFine "<Trace_Name>", "A1" | ...
```

10.7.3.2 More Wave Quantities Dialog

The "More Wave Quantities" dialog provides arbitrary wave quantities with arbitrary source ports as measured quantities. All wave quantities can be calculated with different detector settings.

Access: [Meas] > "Wave" > "More Wave Quantities..."



Background information

Refer to the following sections:

- [Chapter 9.3.5.1, "Wave Quantities"](#), on page 226
- [Chapter 9.3.5.2, "Ratios"](#), on page 226

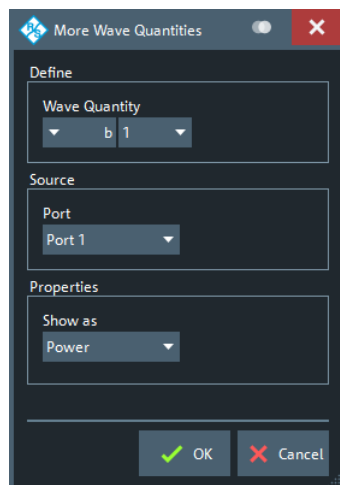

The notation for wave quantities follows the usual scheme of the vector network analyzer:

- The a-waves are the outgoing/transmitted waves at the analyzer's test ports.
- The b-waves are the incoming/measured waves.
- The source port for the stimulus signal must be specified in addition.
- The port number range covers all test ports of the analyzer.

Wave Quantity

Selects the type (left pull-down list) and the port number assignment (right pull-down list) of the [wave quantity](#).

Remote command:

```
CALCulate<Ch>:PARAmeter:MEASure "<Trace_Name>", "A1" ...
CALCulate<Ch>:PARAmeter:SDEFine "<Trace_Name>", "A1" ...
```

Source > Port

Selects the source port for the stimulus signal ("Port 1" or "Port 2").

The analyzer places no restriction on the combination of source ports and port numbers of the measured wave quantity. For example, it is possible to measure a_2 while port 1 is the source port (e.g. to estimate the directivity of the internal test set's directional element).

Remote command:

```
CALCulate<Ch>:PARAmeter:MEASure "<Trace_Name>", "A1" ...
CALCulate<Ch>:PARAmeter:SDEFine "<Trace_Name>", "A1" ...
```

Show as

Selects the physical unit of the displayed trace. It is possible to display the measured "Voltage" V or to convert it into a power value P according to the formula

$$P = V^2 / \operatorname{Re}(Z_0).$$

Z_0 denotes the reference impedance of the source port (for wave quantities a_n) or of the receive port (for wave quantities b_n). The reference impedances are defined in the "Balanced Ports" dialog; see [Chapter 10.7.1.3, "Balanced Ports Dialog"](#), on page 379.

Remote command:

```
CALCulate<Chn>:FORMat:WQUType
```

10.7.4 Z←Sij Tab

Selects converted impedances as measured quantities. The impedances are calculated from the measured S-parameters.

**Background information**

Refer to the following sections:

- [Chapter 9.3.3, "Impedance Parameters"](#), on page 221
- [Chapter 9.3.3.1, "Converted Impedances"](#), on page 221



Z←S<out><in> selector

Selects a [converted impedance](#) parameter as a measured quantity for the active trace. For an n-port vector network analyzer, the pull-down list provides the full set of n^2 impedance parameters.

Converted impedance parameters are expressed as $Z_{\leftarrow S_{\langle out \rangle \langle in \rangle}}$, where <out> and <in> denote the output and input port numbers of the DUT.

Remote command:

```
CALCulate<Ch>:PARAMeter:MEASure "<Trace_Name>", "Z-S11" |
"Z-S12" ...
CALCulate<Ch>:PARAMeter:SDEFine "<Trace_Name>", "Z-S11" |
"Z-S22" | ...
```

Z←S<out><in> softkeys

Selects the 2-port [converted impedance](#) parameters. The parameters describe the impedances of a 2-port DUT, obtained in forward and reverse transmission and reflection measurements:

- Z_{11} is the input impedance at port 1 of a 2-port DUT that is terminated at port 2 with the reference impedance Z_0 (matched-circuit impedance measured in a forward reflection measurement).
- Z_{22} is the input impedance at port 2 of a 2-port DUT that is terminated at port 1 with the reference impedance Z_0 (matched-circuit impedance measured in a reverse reflection measurement).
- Z_{12} and Z_{21} denote the forward and reverse converted transfer impedances, respectively.

Use the Smith chart to obtain an alternative, graphical representation of the converted impedances in a reflection measurement.

Tip: Use the "Y- Z-Params" tab to measure Z-parameters including the transfer parameters.

Remote command:

```
CALCulate<Ch>:PARAMeter:MEASure "<Trace_Name>", "Z-S11" |
"Z-S12" | "Z-S21" | "Z-S22"
CALCulate<Ch>:PARAMeter:SDEFine "<Trace_Name>", "Z-S11" |
"Z-S12" | "Z-S21" | "Z-S22"
```

Model

In case a transmission parameter is selected, you can choose between a [series](#) (default), a [parallel](#), and a [shunt](#) impedance calculation.

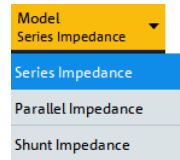

Remote command:

```
CALCulate<Ch>:PARAMeter:MEASure "<Trace_Name>", "Z-S12" |
"Z-S12SER" | "Z-S12PAR" | ...
CALCulate<Ch>:PARAMeter:SDEFine "<Trace_Name>", "Z-S12" |
"Z-S12SER" | "Z-S12PAR" | ...
CALCulate<Ch>:PARAMeter:MEASure "<Trace_Name>", 'SHUNT-S12' |
'SHUNT-S21'
CALCulate<Ch>:PARAMeter:SDEFine "<Trace_Name>", 'SHUNT-S12' |
'SHUNT-S21'
```

Balanced Ports...

Opens a dialog to configure the logical ports of the analyzer.

See [Chapter 10.7.1.3, "Balanced Ports Dialog"](#), on page 379.

10.7.5 $Y \leftarrow S_{ij}$ Tab

Selects converted admittances as measured quantities. The admittances are calculated from the measured S-parameters.



Background information

Refer to the following sections:

- [Chapter 9.3.4, "Admittance Parameters"](#), on page 224
- [Chapter 9.3.4.1, "Converted Admittances"](#), on page 224

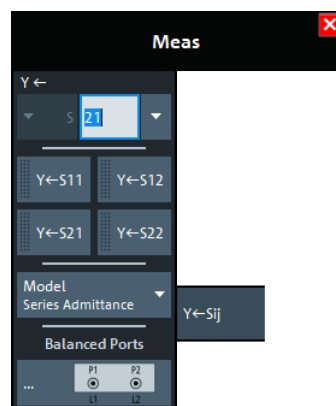

Y←S<out><in> selector

Selects a [converted admittance](#) parameter as a measured quantity for the active trace. For an n-port vector network analyzer, the pull-down list provides the full set of n^2 admittance parameters.

Converted admittance parameters are expressed as $Y_{\leftarrow S_{\leftarrow \text{out}} \leftarrow \text{in}} \rightleftarrows$, where <out> and <in> denote the output and input port numbers of the DUT.

Remote command:

```
CALCulate<Ch>:PARAMeter:MEASure "<Trace_Name>", "Y-S11" |
"Y-S12" ...
CALCulate<Ch>:PARAMeter:SDEFine "<Trace_Name>", "Y-S11" |
"Y-S22" | ...
```

Y←S<out><in> softkeys

Selects the 2-port [converted admittance](#) parameters. The parameters describe the admittances of a 2-port DUT, obtained in forward and reverse transmission and reflection measurements:

- Y_{11} is the input admittance at port 1 of a 2-port DUT that is terminated at port 2 with the reference impedance Z_0 (matched-circuit admittance measured in a forward reflection measurement).
- Y_{22} is the input admittance at port 2 of a 2-port DUT that is terminated at port 1 with the reference impedance Z_0 (matched-circuit admittance measured in a reverse reflection measurement).
- Y_{12} and Y_{21} denote the forward and reverse converted transfer admittances, respectively.

Use the Smith chart to obtain an alternative, graphical representation of the converted impedances in a reflection measurement.

Tip: Use the "Y- Z-Params" tab to measure Y-parameters including the transfer parameters.

Remote command:

```
CALCulate<Ch>:PARAMeter:MEASure "<Trace_Name>", "Y-S11" |
"Y-S12" | "Y-S21" | "Y-S22"
CALCulate<Ch>:PARAMeter:SDEFine "<Trace_Name>", "Y-S11" |
"Y-S12" | "Y-S21" | "Y-S22"
```

Model

In case a transmission parameter is selected, you can choose between a [series](#) (default), and a [parallel](#) admittance calculation.

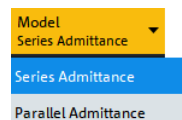

Remote command:

```
CALCulate<Ch>:PARAMeter:MEASure "<Trace_Name>", "Y-S12" |
"Y-S12SER" | "Y-S12PAR" | ...
CALCulate<Ch>:PARAMeter:SDEFine "<Trace_Name>", "Y-S12" |
"Y-S12SER" | "Y-S12PAR" | ...
```

Balanced Ports...

Opens a dialog to configure the logical ports of the analyzer.

See [Chapter 10.7.1.3, "Balanced Ports Dialog"](#), on page 379.

10.7.6 Y-Z-Params Tab

Allows you to select Y- and Z-parameters as measured quantities. Both Y- and Z-parameters can serve as an alternative to S-parameters for characterizing a linear n-port network.

**Background information**

Refer to the following sections:

- [Chapter 9.3.3, "Impedance Parameters"](#), on page 221
- [Chapter 9.3.4, "Admittance Parameters"](#), on page 224
- [Chapter 9.3.3.2, "Z-Parameters"](#), on page 223
- [Chapter 9.3.4.2, "Y-Parameters"](#), on page 224

**Y/Z-Parameter**

Selects an [Y-parameter](#) or [Z-parameter](#) as a measured quantity for the active trace. For an n-port vector network analyzer, the pull-down list provides the full set of n^2 Y- and Z-parameters.

Y- and Z-parameters are expressed as $Y/Z_{\text{out}<in>}$, where <out> and <in> denote the output and input port numbers of the DUT.

Remote command:

```
CALCulate<Ch>:PARAmeter:MEASure "<Trace_Name>", "Y11" |
"Z11" ...
CALCulate<Ch>:PARAmeter:SDEFine "<Trace_Name>", "Y11" |
"Z11" ...
```

Y11/Y12 /Y21/Y22

Selects one of the 2-port [Chapter 9.3.4.2, "Y-Parameters"](#), on page 224 as a measured quantity for the active trace. The Y-parameters describe the admittances of a DUT with output ports terminated in a short circuit ($V = 0$).

The four 2-port Y-parameters can be interpreted as follows:

- Y_{11} is the input admittance, defined as the ratio of the current I_1 to the voltage V_1 , measured at port 1 (forward measurement with output terminated in a short circuit, $V_2 = 0$).
- Y_{21} is the forward transfer admittance, defined as the ratio of the current I_2 to the voltage V_1 (forward measurement with output terminated in a short circuit, $V_2 = 0$).
- Y_{12} is the reverse transfer admittance, defined as the ratio of the current I_1 to the voltage V_2 (reverse measurement with input terminated in a short circuit, $V_1 = 0$).
- Y_{22} is the output admittance, defined as the ratio of the current I_2 to the voltage V_2 , measured at port 2 (reverse measurement with input terminated in a short circuit, $V_1 = 0$).

Remote command:

```
CALCulate<Ch>:PARAmeter:MEASure "<Trace_Name>", "Y11" | "Y12" | "Y21" | "Y22"
```

```
CALCulate<Ch>:PARAmeter:SDEFine "<Trace_Name>", "Y11" | "Y12" | "Y21" | "Y22"
```

Z11 / Z12 / Z21 / Z22

Selects one of the 2-port [Chapter 9.3.3.2, "Z-Parameters"](#), on page 223 as a measured quantity for the active trace. The Z-parameters describe the impedances of a DUT with open output ports ($I = 0$).

The four 2-port Z-parameters can be interpreted as follows:

- Z_{11} is the input impedance, defined as the ratio of the voltage V_1 to the current I_1 , measured at port 1 (forward measurement with open output, $I_2 = 0$).
- Z_{21} is the forward transfer impedance, defined as the ratio of the voltage V_2 to the current I_1 (forward measurement with open output, $I_2 = 0$).
- Z_{12} is the reverse transfer impedance, defined as the ratio of the voltage V_1 to the current I_2 (reverse measurement with open input, $I_1 = 0$).
- Z_{22} is the output impedance, defined as the ratio of the voltage V_2 to the current I_2 , measured at port 2 (reverse measurement with open input, $I_1 = 0$).

Remote command:

```
CALCulate<Ch>:PARAmeter:MEASure "<Trace_Name>", "Z11" | "Z12" | "Z21" | "Z22"
```

```
CALCulate<Ch>:PARAmeter:SDEFine "<Trace_Name>", "Z11" | "Z12" | "Z21" | "Z22"
```

Balanced Ports...

Opens a dialog to define a balanced port configuration.

See [Balanced Ports Dialog](#).

10.7.7 Stability Tab

Selects one of the three two port stability factors K , μ_1 or μ_2 as measured quantities. A typical application of stability factors is to assess the stability of an amplifier. Stability factors cannot be calculated in balanced port configurations.



Background information

Refer to [Chapter 9.3.7, "Stability Factors"](#), on page 230.

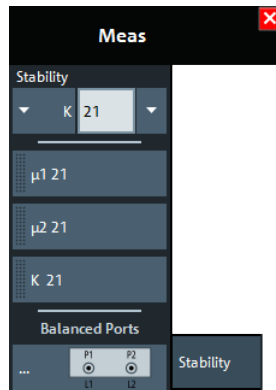

Stability

Selects a [stability factor](#) as a measured quantity for the active trace. The stability factor calculation is based on 2-port reflection **and** transmission S-parameters so that the input and output port numbers must be different. The pull-down list contains all possible physical (single-ended) port combinations. For an analyzer with n ports, provides $n * (n - 1)$ stability parameters.

Stability parameters are expressed as " $K_{\langle out \rangle \langle in \rangle}$ ", " $\mu 1_{\langle out \rangle \langle in \rangle}$ ", and " $\mu 2_{\langle out \rangle \langle in \rangle}$ ", where $\langle out \rangle$ and $\langle in \rangle$ denote the logical output and input port numbers of the DUT.

Remote command:

```
CALCulate<Ch>:PARAmeter:MEASure "<Trace_Name>", "KFAC21" |
"MU121" | "MU221" | ...
```

```
CALCulate<Ch>:PARAmeter:SDEFine "<Trace_Name>", "KFAC21" |
"MU121" | "MU221" | ...
```

$\mu 1$ 21/ $\mu 2$ 21/ K 21

Selects one of the standard 2-port [stability factors](#) as a measured quantity for the active trace. These buttons are enabled if none of the logical ports 1 and 2 is defined as a balanced port.

Remote command:

```
CALCulate<Ch>:PARAmeter:MEASure "<Trace_Name>", "MU121" |
"MU221" | "KFAC21"
```

```
CALCulate<Ch>:PARAmeter:SDEFine "<Trace_Name>", "MU121" |
"MU221" | "KFAC21"
```

Balanced Ports...

Opens a dialog to define a balanced port configuration.

See [Chapter 10.7.1.3, "Balanced Ports Dialog"](#), on page 379.

10.8 Format Softtool

The "Format" softtool allows you to define how the measured data is presented in the diagram area.

Access: [Format]



Measured quantities and display formats

The analyzer allows arbitrary combinations of display formats and measured quantities (see [Chapter 10.7, "Meas Softtool"](#), on page 375). Nevertheless, to extract useful information from the data, it is important to select a display format which is appropriate to the analysis of a particular measured quantity.

An extended range of formats is available for markers. To convert any point on a trace, create a marker and select the appropriate marker format (see ["Marker Format"](#) on page 433). Marker and trace formats can be applied independently.



Background information

Refer to the following sections:

- [Chapter 9.2.3, "Trace Formats"](#), on page 209
- [Chapter 9.2.3.3, "Measured Quantities and Trace Formats"](#), on page 217

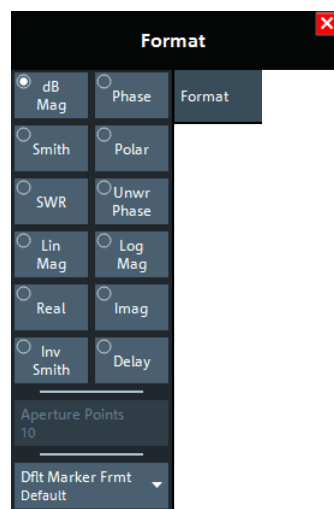

dB Mag

Selects a Cartesian diagram with a dB scale of the vertical axis to display the magnitude of the complex measured quantity.

Properties: The stimulus variable appears on the horizontal axis, scaled linearly. The magnitude of the complex quantity C , i.e. $|C| = \sqrt{\text{Re}(C)^2 + \text{Im}(C)^2}$, appears on the vertical axis, scaled in dB. The decibel conversion is calculated according to dB $\text{Mag}(C) = 20 * \log(|C|)$ dB.

Application: dB Mag is the default format for the complex, dimensionless S-parameters. The dB-scale is the natural scale for measurements related to power ratios (insertion loss, gain etc.).

Tip (alternative formats): The magnitude of each complex quantity can be displayed on a linear scale. It is possible to view the real and imaginary parts instead of the magnitude and phase. Both the magnitude and phase are displayed in the polar diagram.

Remote command:

`CALCulate<Chn>:FORMat MLOGarithmic`

Phase

Selects a Cartesian diagram with a linear vertical axis to display the phase of a complex measured quantity in the range between -180 degrees and $+180$ degrees.

Properties: The stimulus variable appears on the horizontal axis, scaled linearly. The phase of the complex quantity C , i.e. $\varphi(C) = \arctan(\text{Im}(C) / \text{Re}(C))$, appears on the vertical axis. $\varphi(C)$ is measured relative to the phase at the start of the sweep (reference phase = 0°). If $\varphi(C)$ exceeds $+180^\circ$ the curve jumps by -360° ; if it falls below -180° , the trace jumps by $+360^\circ$. The result is a trace with a typical sawtooth shape. The alternative "Unwr Phase" format avoids this behavior.

Application: Phase measurements, e.g. phase distortion, deviation from linearity.

Tip (alternative formats): The magnitude of each complex quantity can be displayed on a linear scale or on a logarithmic scale. It is possible to view the real and imaginary parts instead of the magnitude and phase. Both the magnitude and phase are displayed in the polar diagram. As an alternative to direct phase measurements, the analyzer provides the derivative of the phase response for a frequency sweep ([Delay](#)).

Remote command:

`CALCulate<Chn>:FORMat PHASe`

Smith

Selects a Smith chart to display a complex quantity, primarily a reflection S-parameter.

Properties: The Smith chart is a circular diagram obtained by mapping the positive complex semi-plane into a unit circle. Points with the same resistance are located on circles, points with the same reactance produce arcs. If the measured quantity is a complex reflection coefficient S_{ij} , then the unit Smith chart represents the normalized impedance. In contrast to the polar diagram, the scaling of the diagram is not linear.

Application: Reflection measurements; see example in "[Smith](#)" on page 213.

Tip: The axis for the sweep variable is lost in Smith charts but the marker functions easily provide the stimulus value of any measurement point. dB values for the magnitude and other conversions can be obtained by the "Marker Format" functions.

Remote command:

`CALCulate<Chn>:FORMat SMITh`

Polar

Selects a polar diagram to display a complex quantity, primarily an S-parameter or ratio.

Properties: The polar diagram shows the measured data (response values) in the complex plane with a horizontal real axis and a vertical imaginary axis. The magnitude of a complex value is determined by its distance from the center, its phase is given by the angle from the positive horizontal axis. In contrast to the Smith chart, the scaling of the axes is linear.

Application: Reflection or transmission measurements, see example in "Polar" on page 212.

Tip: The axis for the sweep variable is lost in polar diagrams but the marker functions easily provide the stimulus value of any measurement point. dB values for the magnitude and other conversions can be obtained by the "Marker Format" functions.

Remote command:

`CALCulate<Chn>:FORMat POLar`

SWR

Calculates the standing wave ratio (SWR) from the measured quantity (typically a reflection S-parameter) and displays it in a Cartesian diagram.

Properties: The SWR (or voltage standing wave ratio, VSWR) is a measure of the power reflected at the input of the DUT. It is calculated from the magnitude of the reflection coefficients S_{ii} (where i denotes the port number of the DUT) according to:

$$SWR = \frac{1 + |S_{ii}|}{1 - |S_{ii}|}$$

The superposition of incident and reflected wave on the transmission line connecting the analyzer and the DUT causes an interference pattern with variable envelope voltage. The SWR is the ratio of the maximum voltage to the minimum envelope voltage along the line.

Interpretation of the SWR

The superposition of the incident wave I and the reflected wave R on the transmission line connecting the analyzer and the DUT causes an interference pattern with variable envelope voltage. The SWR is the ratio of the maximum voltage to the minimum envelope voltage along the line:

$$SWR = V_{Max}/V_{Min} = (|V_I| + |V_R|) / (|V_I| - |V_R|) = (1 + |S_{ii}|) / (1 - |S_{ii}|)$$

Application: Reflection measurements with conversion of the complex S-parameter to a real SWR.

Remote command:

`CALCulate<Chn>:FORMat SWR`

Unwr Phase

Selects a Cartesian diagram with an arbitrarily scaled linear vertical axis to display the phase of the measured quantity.

Properties: The stimulus variable appears on the horizontal axis, scaled linearly. The phase of the complex quantity C , i.e. $\varphi(C) = \arctan(\text{Im}(C) / \text{Re}(C))$, appears on the vertical axis. $\varphi(C)$ is measured relative to the phase at the start of the sweep (reference phase = 0°). In contrast to the normal **Phase** format, the display range is not limited to values between -180° and $+180^\circ$. This format avoids artificial jumps of the trace but can entail a relatively wide phase range if the sweep span is large.

Application: Phase measurements, e.g. phase distortion, deviation from linearity.

Tip: After changing to the "Unwr Phase" format, use the "Auto Scale Trace" function to rescale the vertical axis and view the entire trace (see "Auto Scale Trace" on page 302).

Remote command:

`CALCulate<Chn>:FORMat UPHase`

Lin Mag

Selects a Cartesian diagram with a linear vertical axis scale to display the magnitude of the measured quantity.

Properties: The stimulus variable appears on the horizontal axis, scaled linearly. The magnitude of the complex quantity C , i.e. $|C| = \sqrt{\text{Re}(C)^2 + \text{Im}(C)^2}$, appears on the vertical axis, also scaled linearly.

Application: Real measurement data (i.e. the stability factors and the DC voltages) are always displayed in a Lin Mag diagram.

Tip (alternative formats): The magnitude of each complex quantity can be displayed on a logarithmic scale. It is possible to view the real and imaginary parts instead of the magnitude and phase.

Remote command:

`CALCulate<Chn>:FORMat MLINear`

Log Mag

Selects a Cartesian diagram with a logarithmic (base 10) vertical axis scale to display the magnitude of the measured quantity.

Properties: The stimulus variable appears on the horizontal axis, scaled linearly. The magnitude of the complex quantity C , i.e. $|C| = \sqrt{\text{Re}(C)^2 + \text{Im}(C)^2}$, appears on the vertical axis, scaled logarithmically.

Application: Impedance measurements

Remote command:

`CALCulate<Chn>:FORMat LOGarithmic`

Real

Selects a Cartesian diagram to display the real part of a complex measured quantity.

Properties: The stimulus variable appears on the horizontal axis, scaled linearly. The real part $\text{Re}(C)$ of the complex quantity $C = \text{Re}(C) + j \text{Im}(C)$, appears on the vertical axis, also scaled linearly.

Application: The real part of an impedance corresponds to its resistive portion.

Tip (alternative formats): It is possible to view the magnitude and phase of a complex quantity instead of the real and imaginary part. The magnitude can be displayed on a linear scale or on a logarithmic scale. Both the real and imaginary parts are displayed in the polar diagram.

Remote command:

```
CALCulate<Chn>:FORMat REAL
```

Imag

Selects a Cartesian diagram to display the imaginary part of a complex measured quantity.

Properties: The stimulus variable appears on the horizontal axis, scaled linearly. The imaginary part $\text{Im}(C)$ of the complex quantity $C = \text{Re}(C) + j \text{Im}(C)$, appears on the vertical axis, also scaled linearly.

Application: The imaginary part of an impedance corresponds to its reactive portion. Positive (negative) values represent inductive (capacitive) reactance.

Tip (alternative formats): It is possible to view the magnitude and phase of a complex quantity instead of the real and imaginary part. The magnitude can be displayed on a linear scale or on a logarithmic scale. Both the real and imaginary parts are displayed in the polar diagram.

Remote command:

```
CALCulate<Chn>:FORMat IMAGinary
```

Inv Smith

Selects an inverted Smith chart to display a complex quantity, primarily a reflection S-parameter.

Properties: The inverted Smith chart is a circular diagram obtained by mapping the positive complex semi-plane into a unit circle. If the measured quantity is a complex reflection coefficient S_{ij} , then the unit inverted Smith chart represents the normalized admittance. In contrast to the polar diagram, the scaling of the diagram is not linear.

Application: Reflection measurements, see example in "Inv Smith" on page 215.

Tip: The axis for the sweep variable is lost in Smith charts but the marker functions easily provide the stimulus value of any measurement point. dB values for the magnitude and other conversions can be obtained by the "Marker Format" functions.

Remote command:

```
CALCulate<Chn>:FORMat ISMith
```

Delay

Calculates the (group) delay from the measured quantity (typically a transmission S-parameter) and displays it in a Cartesian diagram.

Properties: The group delay τ_g represents the propagation time of wave through a device. τ_g is a real quantity and is calculated as the negative of the derivative of its phase response. A non-dispersive DUT shows a linear phase response, which produces a constant delay (a constant ratio of phase difference to frequency difference).

For more information, refer to [Chapter 9.3.8, "Delay, Aperture, Electrical Length"](#), on page 230.

Application: Transmission measurements, especially with the purpose of investigating deviations from linear phase response and phase distortions. To obtain the delay, a frequency sweep must be active.

Tip: The cables between the analyzer test ports and the DUT introduce an unwanted delay, which often can be assumed to be constant. Use the Zero Delay at Marker function, define a numeric length "Offset" or use the "Auto Length" function to compensate for this effect in the measurement results. To compensate for a frequency-dependent delay in the test setup, a system error correction is required.

Note: The delay for reflection factors corresponds to the transmission time in forward and reverse direction; see ["Length and delay measurement, related settings"](#) on page 267.

Remote command:

`CALCulate<Chn>:FORMat GDElay`

Aperture Points

Defines an aperture Δf for the (group) "Delay" calculation. The value is entered as number of "Aperture Points" (i.e. sweep steps).

Properties: The delay at each sweep point is computed as:

$$\tau_{g,meas} = -\frac{\Delta\phi_{deg}}{360^\circ \cdot \Delta f}$$

where the aperture Δf is a finite frequency interval around the sweep point f_0 and the analyzer measures the corresponding phase change $\Delta\Phi$.

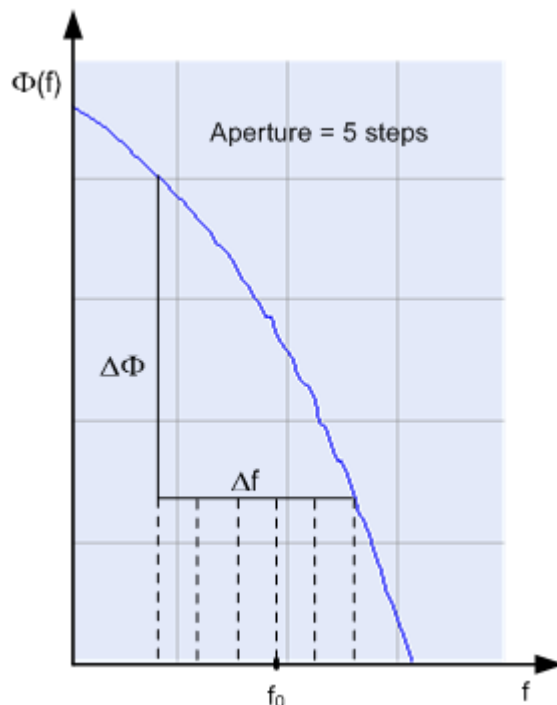

Calculation of Δf and $\Delta\Phi$

With n sweep steps the delay at sweep point no. m is calculated as follows:

- If n is even ($n = 2k$), then $\Delta f(m) = f(m+k) - f(m-k)$ and $\Delta\Phi(m) = \Delta\Phi(m+k) - \Delta\Phi(m-k)$.
- If n is odd ($n = 2k+1$), then $\Delta f(m) = f(m+k) - f(m-k-1)$ and $\Delta\Phi(m) = \Delta\Phi(m+k) - \Delta\Phi(m-k-1)$.

The calculated phase difference (and thus the group delay) is always assigned to the frequency point no. m .

For linear sweeps, if the number of aperture steps is odd, then the center of the aperture range is $[f(m+k) + f(m-k-1)] / 2 = f(m-1/2)$. I.e. the center is half a frequency step below the sweep point $f(m)$. Hence, toggling from even to odd numbers of aperture steps and back can virtually shift the group delay curve towards higher/lower frequencies. It is recommended, to use even numbers of aperture steps, especially for large frequency step sizes.

The delay calculation is based on the already measured sweep points and does not slow down the measurement.

Δf is constant over the entire sweep range, if the sweep type is a Lin. Frequency sweep. For logarithmic and segmented frequency sweeps, it varies with the sweep point number m .

Application: The aperture must be adjusted to the conditions of the measurement. A small aperture increases the noise in the group delay; a large aperture tends to minimize the effects of noise and phase uncertainty, but at the expense of frequency resolution. Phase distortions (i.e. deviations from linear phase) which are narrower in frequency than the aperture tend to be smeared over and cannot be measured.

Remote command:

```
CALCulate<Chn>:GDAPerture:SCount
```

Dflt Marker Frmt

Defines the default marker format of the active trace. "Default" means formatted according to the selected trace format.

New markers are formatted with the trace's "Dflt Marker Frmt"; existing markers are reformatted if (and only if) their [Marker Format](#) is set to (Trace) "Default".

For background information on marker formats, see "[Marker Format](#)" on page 201.

Remote command:

```
CALCulate<Chn>:MARKer:DEFault:FORMat
```

10.9 Display Lines Softtool

The "Display Lines" softtool allows you to control display and limit line settings.

Access: [Display Lines]

Display settings ("Diagram", "Split" and "Config" tabs) comprise all functions for activating, modifying and arranging diagrams.



Background information for display settings

Refer to the following sections:

- [Chapter 9.1.3, "Traces, Channels and Diagrams"](#), on page 187
- [Chapter 9.2.1, "Display Elements of a VNA Diagram"](#), on page 196

Limit lines settings define limits for the measurement results, visualize them in the diagrams and activate/deactivate the limit check. The analyzer provides upper, lower, ripple and circle limits. Furthermore, functions to limit complex diagrams to a user-defined "Display Circle" and to add user-defined horizontal lines to cartesian diagrams are available.



Background information for lines settings

Refer to [Chapter 9.4.1, "Limit Check"](#), on page 231.

• Diagram Tab	402
• Split Tab	405
• Config Tab	407
• Limit Test Tab	411
• Ripple Test Tab	419
• Circle Test Tab	424
• Display Circle Tab	427
• Horiz. Line Tab	428

10.9.1 Diagram Tab

Selects a diagram as the active diagram, defines a title, deletes or adds diagrams and arranges them on the screen. Many of the functions are unavailable if the active channel setup contains only one diagram.

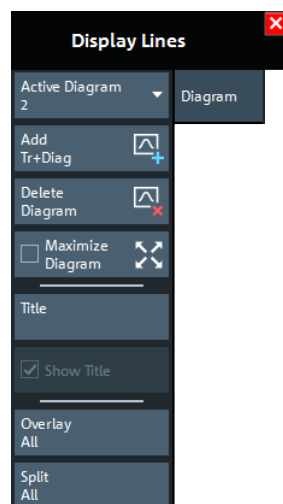

Active Diagram

Selects the active diagram.

Each channel setup screen can display several diagrams simultaneously, each with a variable number of traces. One of these diagrams and traces is active at each time. The diagram number (or name) in the upper right corner of the active diagram is highlighted. At the same time, the active trace is highlighted in the trace list on top of the active diagram (Trc3 in the figure below):

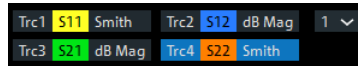

The analyzer provides several tools for activating diagrams:

- tap on a point in the diagram to activate the diagram including the last active trace in the diagram.
- tap on a trace list to activate the trace including the corresponding diagram.
- Some of the functions of the [Traces Tab](#) activate a particular trace including the corresponding diagram.

Remote command:

```
DISPlay[:WINDow<Wnd>]:TRACe<WndTr>:CATalog?
```

Add Trace + Diagram

Creates a diagram and a trace which is displayed in the new diagram. The trace is created with the channel settings of the previous active trace but with default trace settings. The new diagram area is numbered <n>, where <n> is the largest of all existing diagram area numbers plus one.

Remote command:

```
DISPlay[:WINDow<Wnd>][:STATe] ON
```

Delete Diagram

Deletes the current diagram area including all traces displayed in the diagram area. The remaining diagrams are renumbered; each channel setup always contains diagrams with contiguous numbers. "Delete Diag Area" is disabled if the channel setup contains only one diagram area: In manual control, each channel setup must contain at least one diagram area with one channel and one trace.

Tip: To restore a diagram area that was unintentionally deleted, use the undo functionality.

Remote command:

```
DISPlay[:WINDow<Wnd>][:STATe] OFF
```

Maximize Diagram

Maximizes the active diagram or restores the previous diagram arrangement.

For other split types, use the functions in the [Split Tab](#).

Remote command:

```
DISPlay[:WINDow<Wnd>]:MAXimize
```

Title

Defines a title for the [Active Diagram](#).

The visibility of the title area can be toggled using [Show Title](#).

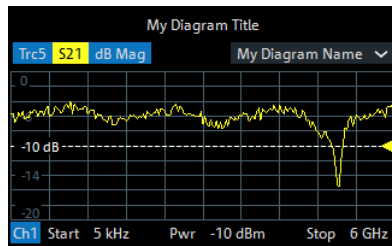

Remote command:

```
DISPlay[:WINDow<Wnd>]:TITLE:DATA
```

Via remote control, it is also possible to define a diagram **name**, and to retrieve the lists of diagrams together with their names:

```
DISPlay[:WINDow<Wnd>]:NAME
```

```
DISPlay[:WINDow<Wnd>]:CATalog?
```

Show Title

Displays or hides the title area of the active diagram.

This property can only be set if **Title** is non-empty. If "Title" is empty, the title area is always hidden

Remote command:

```
DISPlay[:WINDow<Wnd>]:TITLE[:STATE]
```

Overlay All

Places all traces in a single diagram area which is maximized to occupy the whole screen. This function is available irrespective of the trace format and the channel settings; it is even possible to overlay Cartesian and complex diagrams.

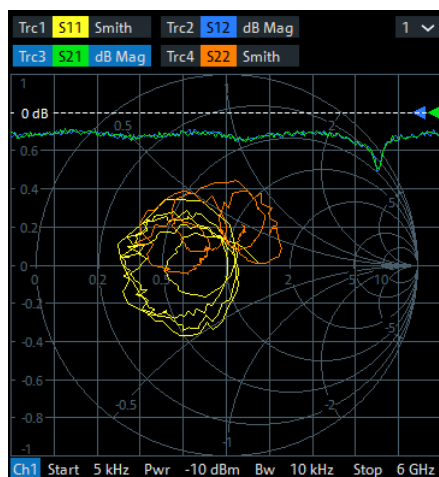

The active trace and active channel is highlighted. The scaling of the axes corresponds to the active trace.

Tip: To hide all traces except one, activate the context menu of the respective trace name segment in the trace list and select "Hide all other Traces".

Remote command:

No command; display configuration only.

Split All

Creates a separate diagram for each trace in the active channel setup and automatically arranges those diagrams in the diagram area. Existing diagrams are deleted during this process.

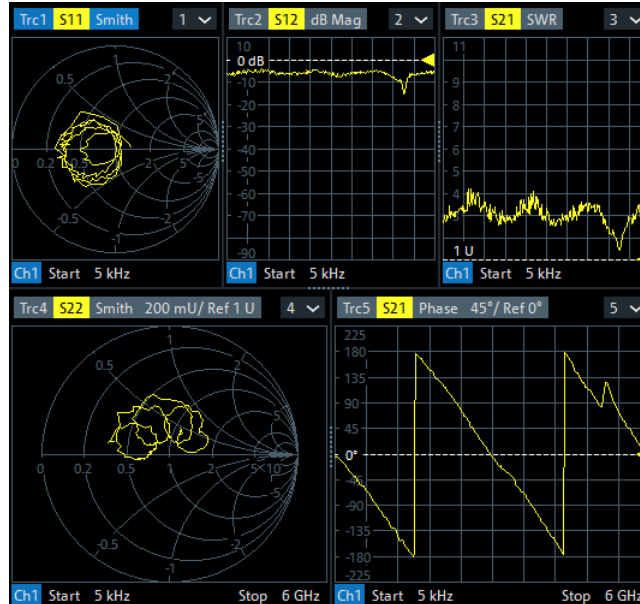

Tip: To vary the size and position of the diagram areas, drag and drop the separating frames or use the functions in the "Split" tab.

Remote command:

No command; display configuration only.

10.9.2 Split Tab

Arranges multiple diagrams on the screen.

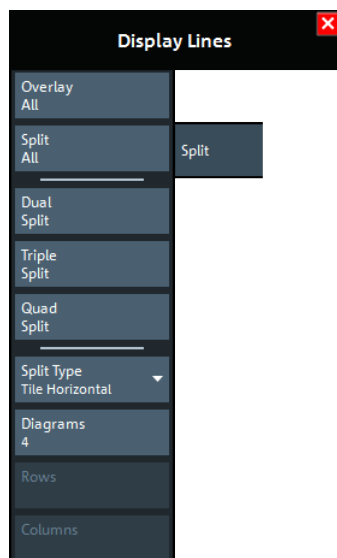

Some of the "Split" settings are also available in the [Diagram Tab](#). Refer to the following sections:

- ["Overlay All"](#) on page 404
- ["Split All"](#) on page 405

Dual Split / Triple Split / Quad Split

Splits the diagram area into two (three / four) diagrams and distributes the traces among the diagrams. Traces with different format and channel settings (e.g. Cartesian and complex diagrams) are separated, if possible. Example of four traces in "Quad Split" display:

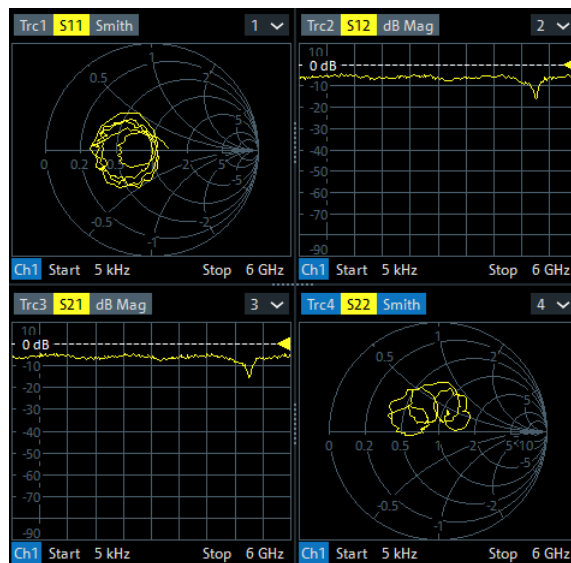

If less than two (three / four) traces are available, the new diagrams are created with a default trace. Dual (triple / quad) split corresponds to "Split Type: Tile Horizontal" with 2 (3 / 4) diagrams.

Tip: To vary the size and position of the diagrams, drag and drop the separating frames or use the functions in the "Diagram" tab.

Remote command:

No command; display configuration only.

Split Type

The R&S ZNL/ZNLE provides the following split types:

- "Lineup": The diagrams are arranged side by side; each diagram occupies the entire screen height.
- "Stack": The diagrams are arranged one below the other; each diagram occupies the entire screen width.
- "Tile Horizontal": The diagrams are arranged in rows. With 2 (3 / 4) diagrams, the result is equivalent to Dual Split (Triple Split / Quad Split); see ["Dual Split / Triple Split / Quad Split"](#) on page 406.
- "Tile Vertical": The diagrams are arranged in columns.
- "Rows + Cols": The diagrams are arranged as a rectangular matrix. The number of rows and columns is as defined in the corresponding input fields.

If the selected number of "Diagrams" exceeds the number of traces, some of the new diagrams are created with a default trace.

Tip: To vary the size and position of the diagrams, drag and drop the separating frames or use the functions in the "Diagram" tab.

Remote command:

```
DISPlay:LAYout
```

Diagrams / Rows / Columns

Selects the number of "Diagrams" (or "Rows" and "Columns") to which the traces in the active channel setup are split. The split is performed according to the selected [Split Type](#).

If the entered number of "Diagrams" exceeds the number of previously existing traces, some of the new diagrams are created with default traces.

For a "Split Type" other than "Rows + Cols", only the total number of "Diagrams" can be specified.

Remote command:

```
DISPlay:LAYout:GRID
```

Additional Functionality: SCPI Commands

The analyzer provides remote control commands for efficient diagram handling. The commands listed below extend the functionality of the "Display > Diagram" and "Display > Split" softtool panels. For programming examples, refer to ["Creating Diagrams"](#) on page 974.

Remote command:

```
DISPlay:LAYout:APPLy
```

```
DISPlay:LAYout:DEFine
```

```
DISPlay:LAYout:EXECute
```

```
DISPlay:LAYout:JOIN
```

10.9.3 Config Tab

Displays or hides controls and information elements of the screen and controls the appearance of the individual diagrams.

Hiding the controls and information elements leaves more space for the diagrams. All elements can be shown or hidden simultaneously.



Related information

Refer to [Chapter 9.2.1, "Display Elements of a VNA Diagram"](#), on page 196.

10.9.3.1 Controls on the Config Tab

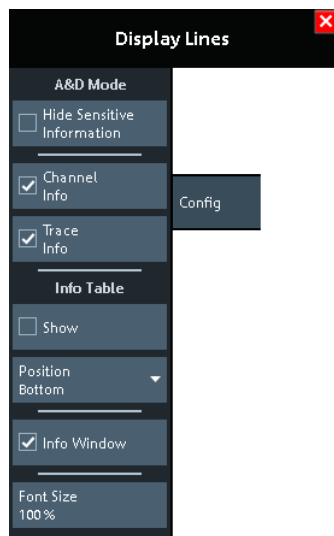

Hide Sensitive Information

Unmasks or masks all stimulus value occurrences in the VNA GUI for the current channel setup.

When you check "Hide Sensitive Information" for a particular channel setup (to mask the stimulus values), you are asked to set a password. If this password is non-empty, it is requested the next time someone tries to uncheck "Hide Sensitive Information" (to unmask all stimulus values) for this channel setup.

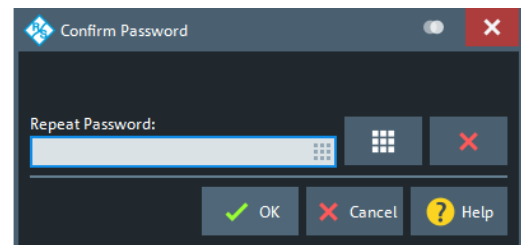
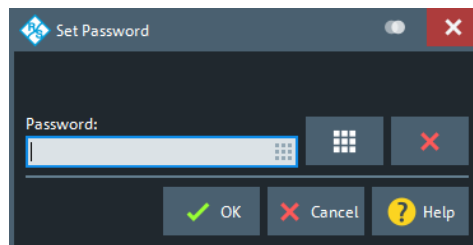

Both checked state and password are stored in (and loaded from) the active channel setup.

Remote command:

```
DISPlay:ANNotation:FREQuency[:STATe]
```

Channel Info

Shows or hides the channel lists in the lower part of the diagrams.

Ch1	Start	5 kHz	—	Pwr	-10 dBm	Bw	10 kHz	Stop	6 GHz
Ch2	Freq	1 GHz	—	Pwr	-10 dBm	Bw	10 kHz	Stop	201
Ch3	Freq	1 GHz	—	Pwr	-10 dBm	Bw	10 kHz	Stop	1 s
Ch4	Start	5 kHz	—	Pwr	-10 dBm	Bw	10 kHz	Stop	6 GHz
Trc4	Start	-1 ns	—	Time Domain				Stop	4 ns

Remote command:

```
DISPlay:ANNotation:CHANnel[:STATe]
```

Trace Info

Shows or hides the trace lists in the upper part of the diagrams.

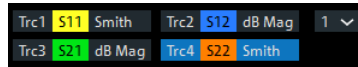

Remote command:

`DISPlay:ANNOtation:TRACe[:STATe]`

Info Table: Show / Position

Shows or hides the info table and defines its position.

The info table is a possible container for info fields and can be placed to the bottom, to the left, or to the right of the screen. See also [Chapter 10.10.4, "Info Field Tab"](#), on page 436.

M1	Trc1	5.130001 GHz	-15.6388 dB	Bandstop Trc1	Ref to Max	Track
M2	Trc1	4.718891 GHz	-7.3323 dB	Bandwidth	535.657892 MHz	
M3	Trc1	5.254549 GHz	-7.3323 dB	Center	4.979523 GHz	
M4	Trc1	4.979523 GHz	-9.5924 dB	Lower Edge	4.718891 GHz	
				Upper Edge	5.254549 GHz	
				Quality Factor (3dB)	9.296 U	
				Loss	15.6388 dB	

Remote command:

No command; display configuration only.

Info Window

Shows/hides the [Info Window](#)

Remote command:

`DISPlay:IWINdow[:STATe]`

Font Size

Scales the fonts in the diagrams. The scaling affects the trace and channel lists, and the info fields.

Remote command:

`DISPlay:RFSiZe`

10.9.3.2 Info Window

The "Info Window" displays a configurable set of marker properties and [Bandfilter Search](#) results. It automatically resizes the displayed text to fit the window height and width.

Access: [Display Lines] > "Config" > "Info Window" checkbox

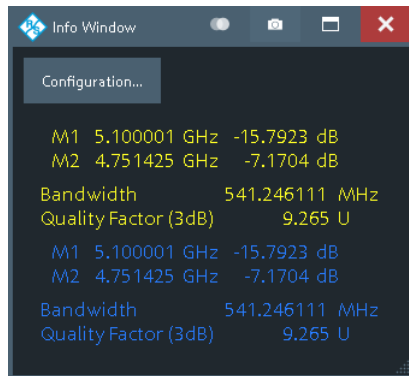

Use the "Configuration..." button to open the [Info Window Configuration Dialog](#) and select the information items to be displayed.

To disambiguate the displayed marker info fields, you can assign descriptive names to the markers (see ["Marker Name"](#) on page 432).



If a trace is hidden, then its marker and bandfilter search info is also hidden in the "Info Window".

Info Window Configuration Dialog

The "Info Window Configuration" dialog allows you to select the markers and [Display Elements of a VNA Diagram](#) results to be displayed in the [Info Window](#).

Access: [Info Window](#) > "Configuration..."

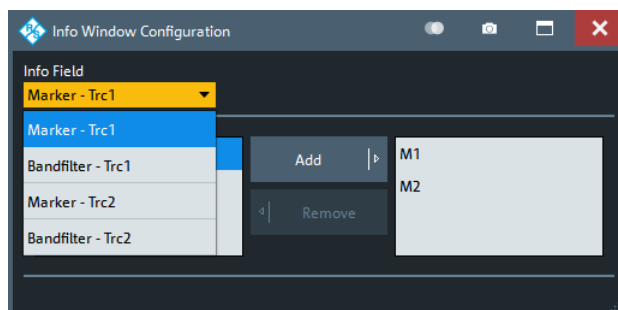

Use the "Info Field" combo box to select a marker or bandfilter search info field whose contents you want to display in parts or in total. It contains all info fields of the current channel setup that are currently not displayed in the info table (see ["Info Table: Show / Position"](#) on page 409).

Content Selection

The lower part of the "Info Window Configuration" dialog allows you to pick the contents of the selected info field you want to display in the [Info Window](#).

For marker info fields, use the "Add" and "Remove" buttons to show/hide the selected marker in the "Info Window".

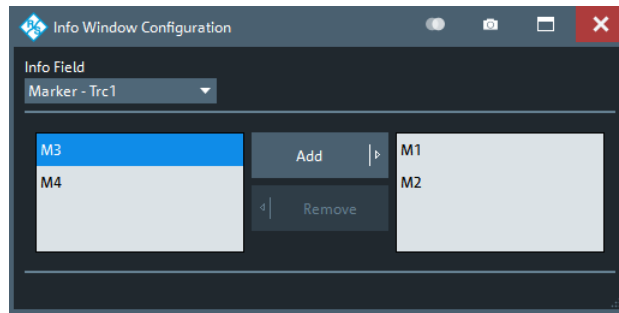

Figure 10-7: Content selection: marker info fields

For [Bandfilter Search](#) info fields simply pick the results to be displayed.

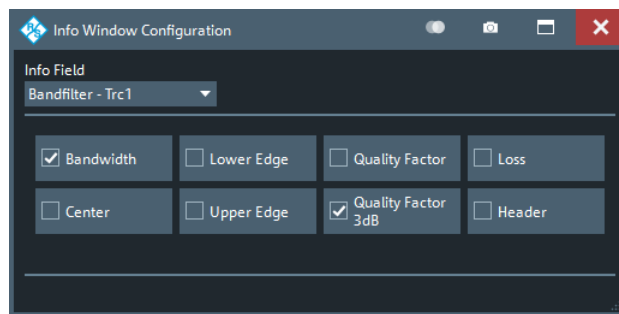

Figure 10-8: Content selection: bandfilter search info fields

Remote command:

```
DISPlay:IWINDOW:MARKer<Mk>[:STATE]
DISPlay:IWINDOW:BFILter[:STATE]
```

10.9.3.3 Additional Settings: Display Colors

You can also control the display colors to a certain extent: see [Chapter 7.2.1.3, "Display Theme and Colors"](#), on page 125.

10.9.4 Limit Test Tab

Defines limit lines for the measurement results (upper and lower limits), visualizes them in the diagrams and activates/deactivates the limit check.

Limit lines are available for all cartesian diagram types; "dB Mag" limits can also be checked in complex diagrams (Smith, Polar).



Background information

Refer to [Chapter 9.4.1, "Limit Check"](#), on page 231.

10.9.4.1 Controls on the Limit Test Tab

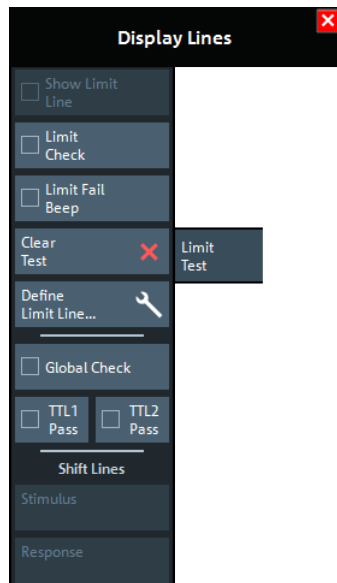

The "Define Limit Line..." button opens the "Define Limit Lines" dialog (see [Chapter 10.9.4.2, "Define Limit Lines Dialog"](#), on page 415).

Show Limit Line

Shows or hides the limit line associated with the active trace in a Cartesian diagram area.

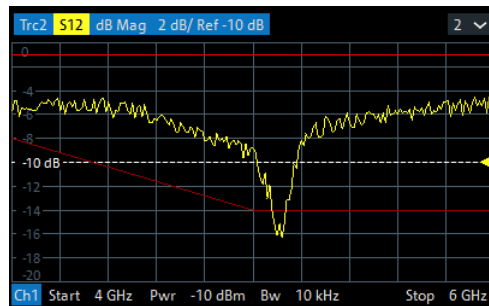

Note: Display of the limit line and limit check are independent of each other: Hiding the limit line does not switch off the limit check.

Remote command:

```
CALCulate<Chn>:LIMit:DISPlay[:STATe]
```

Limit Check

Enables/disables the limit check for the active trace.

If enabled, an additional info field is displayed in the diagram, indicating the "PASS" or "FAIL" state. Limit violations are marked with a colored square. An acoustic signal ([Limit Fail Beep](#)) and a TTL signal indicating pass or fail can be generated in addition.

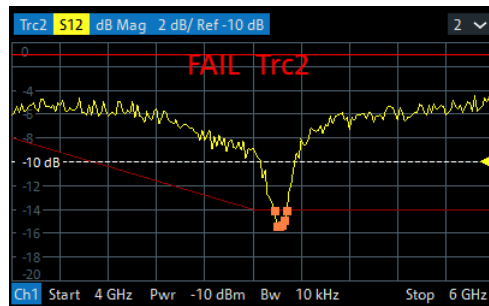
**Note:**

- Limit check and display of limit lines are independent of each other:
 - The limit lines can be displayed, no matter if the limit check is enabled.
 - If "Limit Check" is enabled, the limits are checked, no matter if the limit lines are displayed.
 - The limit check can even be enabled, if no limit lines are defined. In this case, the info field displays "No limit defined!" and the limit check always passes.
- Limit lines are defined for a particular trace format. However, the limit check is performed irrespective of the current trace format. The info field indicates the correct "PASS"/"FAIL" state and limit violations are visualized on the trace (if any).

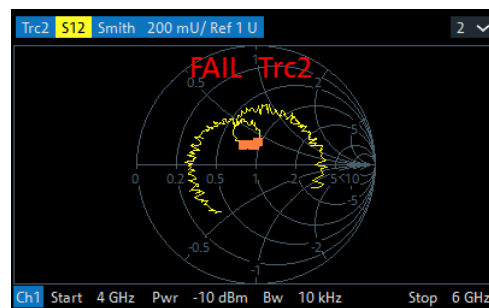

Figure 10-9: Limit line violations in complex trace formats

Remote command:

```
CALCulate<Chn>:LIMit:STATe
CALCulate<Chn>:LIMit:LOWer:STATe
CALCulate<Chn>:LIMit:UPPer:STATe
CALCulate<Chn>:LIMit:FAIL?
CALCulate:LIMit:FAIL:ALL?
CALCulate<Chn>:LIMit:STATe:AREA
```

Limit Fail Beep

Activates or deactivates the fail beep. The fail beep is a low-tone acoustic signal that is generated each time the analyzer detects an exceeded limit. No fail beep can be generated if the limit check is switched off.

Note: The R&S ZNL/ZNLE does not have a built-in audio device and loudspeaker. To hear these sounds, connect a USB audio device to the instrument or operate it via remote desktop.

Remote command:

```
CALCulate<Chn>:LIMit:SOUNd[:STATe]
```

Clear Test

Resets the limit check results.

Remote command:

`CALCulate<Chn>:LIMit:CLEar`

Global Check

Activates or deactivates the global limit check including upper/lower limits and ripple limits. The global limit check is a composite limit check over all traces of the current channel setup. The result of the global check appears in a popup box whenever "Global Check" is selected.



- "PASS" represents pass for all traces with enabled limit check. A trace without limit lines or with disabled individual limit check always passes the global check.
- "FAIL" means that the limit check for one or more traces failed.

Remote command:

`CALCulate:CLIMits:FAIL?`

TTL1 Pass / TTL2 Pass

Assigns the active trace to the low-voltage (3.3 V) TTL output signals at the Aux. Port (see [Chapter 15.3.1.1, "Aux. Port"](#), on page 1014).

Note: Because the Aux. Port is not available for the R&S ZNLE, the "TTL1 Pass" and "TTL2 Pass" checkboxes are not available for these instruments.

Monitoring a single trace

If "TTL1 Pass" ("TTL2 Pass") is selected and the trace passes all active limit checks, then the TTL signal is applied to pin 13 (pin 14) of the Aux. Port. If one of the limit checks fails, then no TTL signal is generated.

Monitoring several traces

If a channel contains several traces, it is possible to assign each of them to any TTL output. The assignment divides the traces of the channel into four groups:

- not assigned to signal 1 or signal 2
- assigned to signal 1, but not to signal 2
- assigned to signal 2, but not to signal 1
- assigned to both signals

If several traces are assigned to a pass/fail signal, then the TTL signal is only generated if all traces are within their respective limits. It is switched off if one trace exceeds those limits.

Application: Graduated quality check

The two pass/fail signals can be used to distinguish three quality levels of a DUT. The test is performed on two identical traces Trc1 and Trc2 within the same channel. Trc1

is configured with a tighter, Trc2 with a looser set of limit lines. For Trc1 "TTL1 Pass" is enabled, for Trc2 "TTL2 Pass".

- TTL1: signal
If Trc1 passes (and so does Trc2), the quality of the DUT is good.
- TTL1: no signal, TTL2: signal
If Trc1 fails but Trc2 passes, the quality of the DUT is still sufficient.
- TTL1: no signal, TTL2: no signal
If both Trc1 and Trc2 fail, the quality is poor.

Instead of using two traces, it is possible to consider two groups of traces that are assigned to "TTL1 Pass" and "TTL2 Pass", respectively.

Remote command:

```
CALCulate<Chn>:LIMit:TTLout<Pt>[:STATe]
```

Shift Lines

By setting the "Stimulus" and "Response" values it is possible to shift a previously defined limit line in x and y direction, respectively, without having to redefine the constituent line segments.

Remote command:

```
CALCulate<Chn>:LIMit:CONTRol:SHIFt
```

```
CALCulate<Chn>:LIMit:UPPer:SHIFt
```

```
CALCulate<Chn>:LIMit:LOWer:SHIFt
```

10.9.4.2 Define Limit Lines Dialog

The "Define Limit Lines" dialog defines the limit lines for the active trace on a segment-by-segment basis. For each segment, the limit is defined as a line connecting two points (with linear or logarithmic "Interpolation"), or as a user-defined formula.

Access: [Display Lines] > "Limit Test" > "Define Limit Line..."



Background information

Refer to [Chapter 9.4.1, "Limit Check"](#), on page 231.

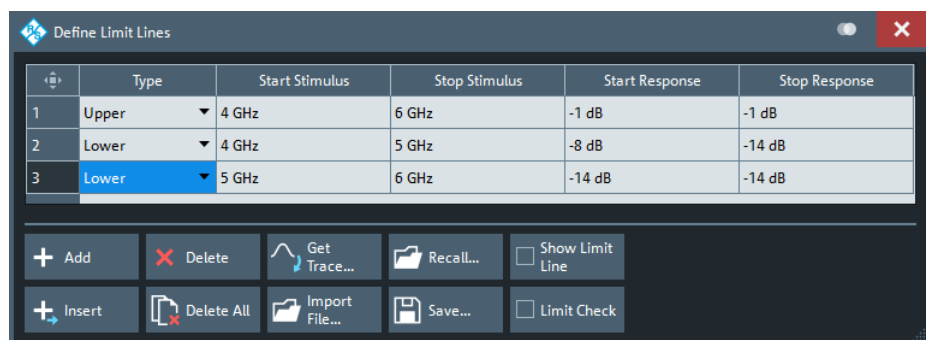



When you switch to a different [sweep type](#), existing limit lines are preserved. With a different sweep variable, however, the limit lines cannot be [displayed](#) and the corresponding [limit check](#) cannot be executed.

If you want to define limit lines for the new sweep variable, you first have to [delete all](#) existing limit lines for the old sweep variable.

Controls on the Define Limit Lines Dialog

The "Define Limit Lines" dialog contains a table to edit the individual segments of the limit lines. The buttons below the table extend or shorten the segment list.



Creating limit lines with minimum effort

Choose one of the following methods to create and handle limit lines efficiently:

- To define limit lines with only a few segments, select "Add" and edit each segment in the [Segment List](#) individually.
- Select a data or memory trace as a limit line ("Import Trace...") or import a trace stored in a file ("Import File...").
- Save your limit lines to a file so you can reuse or modify them later sessions ("Save Limit Line...", "Recall Limit Line...").

Segment List

Defines the individual limit line segments.

The table contains an automatically assigned current number for each segment plus the following editable columns:

- "Type" indicates whether the segment belongs to an "Upper" or a "Lower" limit line, or if the limit check at the segment is switched "Off". Switching off the limit check does not delete the segment but changes its screen color.
- "Start Stimulus" is the stimulus (x-axis) value of the first point of the segment.
- "Stop Stimulus" is the stimulus (x-axis) value of the last point of the segment.
- "Response"
 - For a limit line segment that is defined as linear functions of the stimulus, "Response" displays the y-axis values at the start and stop stimulus (x-axis) values.
 - For formula-defined line segments, it displays the formula.

Tap the "Response" field to open the [Response Dialog](#) that offers the full range of configuration possibilities.

- "Interpolation" determines whether the limit line segment is interpolated linearly or logarithmically. The latter is possibly more suitable for logarithmic sweeps.

Remote command:

```
CALCulate<Chn>:LIMit:SEGMENT:COUNT?
CALCulate<Chn>:LIMit:SEGMENT<Seg>:TYPE
CALCulate<Chn>:LIMit:SEGMENT<Seg>:STIMulus:START
CALCulate<Chn>:LIMit:SEGMENT<Seg>:STIMulus:STOP
CALCulate<Chn>:LIMit:SEGMENT<Seg>:AMPLitude:START
CALCulate<Chn>:LIMit:SEGMENT<Seg>:AMPLitude:STOP
CALCulate<Chn>:LIMit:CONTROL[:DATA]
```



```

CALCulate<Chn>:LIMit:CONTRol:SHIFt
CALCulate<Chn>:LIMit:DATA
CALCulate<Chn>:LIMit:LOWer[:DATA]
CALCulate<Chn>:LIMit:LOWer:SHIFt
CALCulate<Chn>:LIMit:UPPer[:DATA]
CALCulate<Chn>:LIMit:UPPer:FEED
CALCulate<Chn>:LIMit:SEGMENT<Seg>:INTerpol

```

Add / Insert / Delete / Delete All

The first four buttons below the segment list extend or shorten the list. The analyzer places no restriction on the number of segments in a limit line.

- "Add" adds a new segment to the end of the list. The new segment extends from the "Stop Stimulus" value of the last segment to the end of the sweep range. Its response values are equal to the "Stop Response" value of the last segment.
- "Insert" adds a new segment before the active segment (marked by a blue background in the first column of the segment list). The new segment extends from the "Stop Stimulus" value of the segment before the active segment to the "Start Stimulus" value of the active segment. Its response values are equal to the "Start Response" value of the active segment. The segment numbers in the list are adapted.
If no segment is active, "Insert" is equivalent to "Add".
- "Delete" removes the selected segment from the list.
- "Delete All" clears the entire segment list so it is possible to define or load a new limit line.

Remote command:

```
CALCulate<Chn>:LIMit:DELeTe:ALL
```

Recall... / Save...

The buttons open an Open File" or "Save File" dialog, which allows you to load a limit line from a limit line file or store the current limit line configuration to a limit line file.

A limit line file (*.limit) is a text file whose content describes a limit line configuration. See [Chapter 9.4.1.4, "File Format for Limit Lines"](#), on page 237.

Remote command:

```
MMEMory:LOAD:LIMit
```

```
MMEMory:STORe:LIMit
```

Get Trace... / Import File...

- "Get Trace..." opens a dialog to load a limit line from a data or memory trace in the active channel setup.

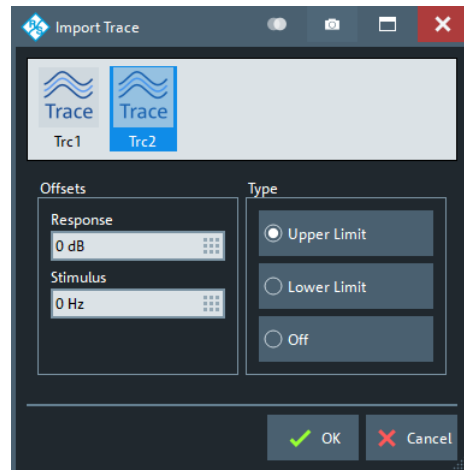

The active trace must be cartesian and the "Format" of the imported trace must be the same as the "Format" of the active trace.

- "Import File..." opens a dialog to load a limit line from a trace file (see [Chapter 10.6.11, "Trace Data Tab"](#), on page 367).

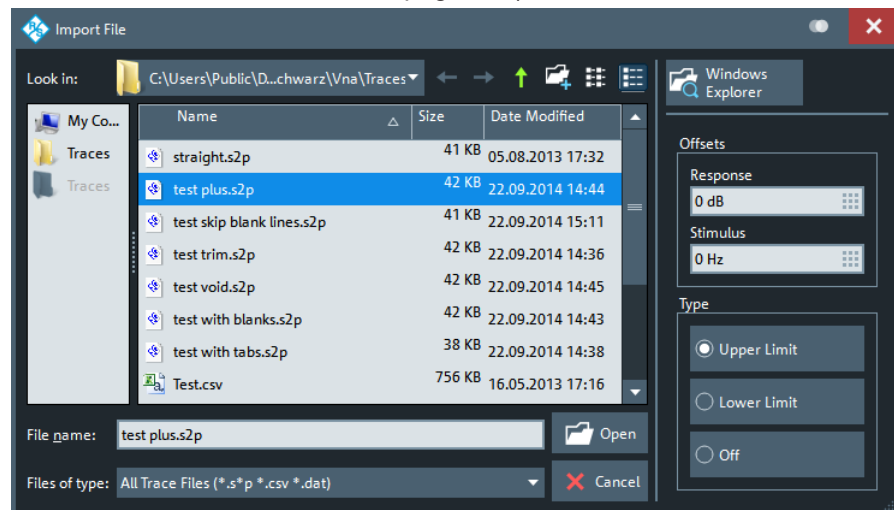

In case the selected file contains more than one trace, another popup dialog lets you select the adequate one:

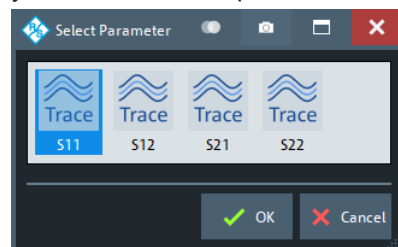

Imported traces are polygonal curves with n points and $n - 1$, where n is the "Number of Points" of the imported trace (see [Chapter 10.5.1, "Sweep Params Tab"](#), on page 309). The $n - 1$ segments are appended to the current segment table for further editing. Existing limit line segments are not overwritten.

Both import dialogs contain the following file import settings:

- "Offsets" contains two input fields to define constant offset values for all imported segments. The "Response" offset shifts all segments in vertical direction, the "Stimulus" offset shifts them in horizontal direction. The offsets are added to the start and stop values of all segments.
- "Type" defines whether the imported segments belong to the "Upper" or "Lower" limit line. A third option is to import the segments but disable the limit check ("Off").

Remote command:

```
CALCulate<Chn>:LIMit:LOWer:FEED
```

```
CALCulate<Chn>:LIMit:UPPer:FEED
```

Response Dialog

The "Response" dialog allows you to configure the limit line segment in detail.

Access: [Define Limit Lines Dialog](#) > "Response" cells

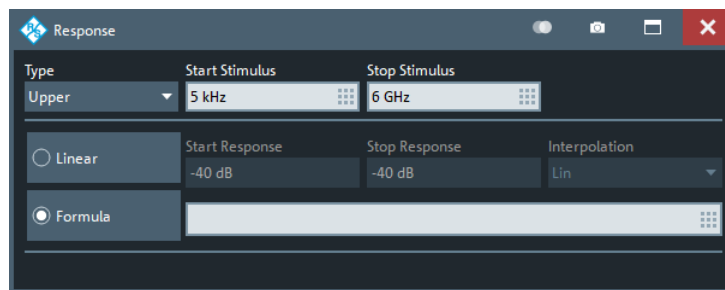

For convenience, "Type", "Start Stimulus", "Stop Stimulus", and "Interpolation" are repeated from the [Segment List](#) of the "Define Limit Lines" dialog.

Linear/Formula

Allows you to decide how to define the line segment.

- "Linear": Define the line segment as a straight line, connecting the endpoints ("Start Stimulus", "Start Response") and ("Stop Stimulus", "Stop Response"). In this case, you can also decide whether linear or logarithmic [interpolation](#) is used.
- "Formula": Define the line segment by a custom formula. You can enter the formula in the text field to the right of the "Formula" button, or Tap and hold the text field to open the [User Def Math Dialog](#).

Remote command:

```
CALCulate<Chn>:LIMit:SEGment<Seg>:FORMula:STATe
```

```
CALCulate<Chn>:LIMit:SEGment<Seg>:FORMula
```

10.9.5 Ripple Test Tab

Defines ripple limits for the measurement results, visualizes them in the diagrams and activates/deactivates the ripple limit check.

A ripple test is a special type of limit test where the **difference** between response values in certain stimulus ranges must not exceed configurable limits (ripple limits).

Ripple limits can be defined for cartesian trace formats only and are limited to the trace format they were configured for. If another format is selected, the ripple limit lines are hidden and the limit check is temporarily disabled.



Background information

Refer to [Chapter 9.4.1, "Limit Check"](#), on page 231.

10.9.5.1 Controls on the Ripple Test Tab

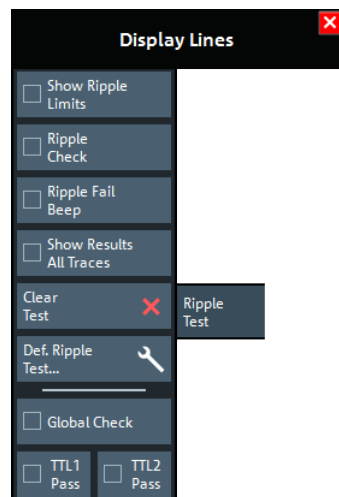

The "Def. Ripple Test..." button opens the "Define Ripple Test" dialog (see [Chapter 10.9.5.2, "Define Ripple Test Dialog"](#), on page 422).

Show Ripple Limits

Shows or hides the ripple limit lines associated with the active trace in a Cartesian diagram area. The vertical positions of the ripple lines are recalculated after each sweep; only their stimulus range and distance (the ripple limit) are fixed.

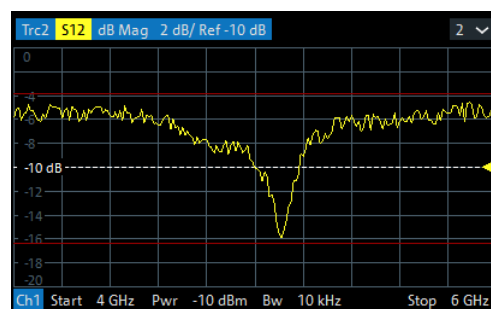

Note: Display of the limit line and limit check are independent of each other: Hiding the limit line does not switch off the limit check.

Remote command:

```
CALCulate<Chn>:RIPPLE:DISPlay[:STATe]
```

Ripple Check

Switches the ripple limit check of the active trace on or off.

When the limit check is switched on, a movable info field shows the pass/fail information and the measured ripple in each ripple limit range. If the ripple limit check fails at a measurement point, the point is marked with a colored square.

An acoustic signal (**Ripple Fail Beep**) and a TTL signal indicating pass or fail can be generated in addition.

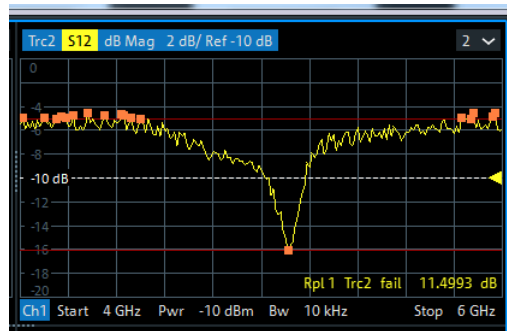

Note:

- Ripple check and display of limit lines are independent of each other:
 - The ripple limits can be displayed, no matter if the ripple check is enabled.
 - If "Ripple Check" is enabled, the ripple limits are checked, no matter if they are displayed.
 - The ripple check can even be enabled, if no limit lines are defined. In this case, the info field displays "No ripple defined!" and the limit check always passes.
- For each trace, ripple limits can only be set for a single cartesian trace format. If another trace format is selected, the ripple limit lines are hidden and the ripple check is suspended.

Remote command:

```
CALCulate<Chn>:RIPPLE:STATE
CALCulate<Chn>:RIPPLE:FAIL?
CALCulate:RIPPLE:FAIL:ALL?
CALCulate<Chn>:RIPPLE:SEGMENT<Seg>:RESULT?
CALCulate<Chn>:RIPPLE:STATE:AREA
```

Ripple Fail Beep

Activates or deactivates the fail beep. The fail beep is a low-tone acoustic signal that is generated each time the analyzer detects an exceeded ripple limit. No fail beep can be generated if the ripple limit check is switched off.

Note: The R&S ZNL/ZNLE does not have a built-in audio device and loudspeaker. To hear these sounds, connect a USB audio device to the instrument or operate it via remote desktop.

Remote command:

```
CALCulate<Chn>:RIPPLE:SOUND[:STATE]
```

Show Results All Traces

Defines the visibility of ripple info fields in the active recall set.

- If disabled, only the ripple info field of the active trace is displayed (in case it has ripple check enabled).
- If enabled, ripple info fields are displayed for all traces with ripple check enabled.

Remote command:

```
CALCulate:RIPple:DISPlay:RESult:ALL[:STATe]
```

Clear Test

Resets the limit check results.

Remote command:

```
CALCulate<Chn>:RIPple:CLEar
```

Global Check

See "[Global Check](#)" on page 414.

TTL1 Pass / TTL2 Pass

See "[TTL1 Pass / TTL2 Pass](#)" on page 414.

10.9.5.2 Define Ripple Test Dialog

The "Define Ripple Test" dialog defines the ripple limits for the active trace on a range-by-range basis. A separate ripple limit can be assigned to each range.

Access: [Display Lines] > "Ripple Test" > "Def. Ripple Test..."

**Defining ripple limits with minimum effort**

Choose one of the following methods to create and handle ripple limit ranges efficiently:

- To configure a limit test with only a few ranges, use "Add" and edit each range in the table individually.
- Use the "Align All" button to create non-overlapping, contiguous ranges of equal width.
- Save your ripple ranges to a file so you can reuse or modify them in later sessions ("Save Ripple Test...", "Recall Ripple Test...").

**Background information**

Refer to [Chapter 9.4.1, "Limit Check"](#), on page 231.

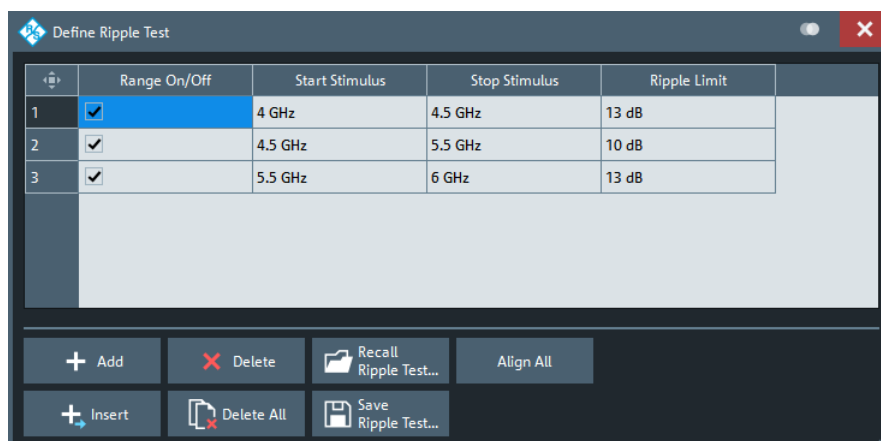

The "Define Ripple Test" dialog contains a table to edit the individual ranges of the ripple check ranges. The buttons below the table extend, shorten, or reorder the range list and save/recall ripple test data.

Range List

Defines the individual ripple limit ranges.

The table contains an automatically assigned current number for each range plus the following editable columns:

- "Range On/Off" enables or disables the ripple limit check in each range. Disabling the ripple limit check does not delete the range but hides the entry in the info field.
- "Start Stimulus" is the smallest stimulus (x-axis) value of the range.
- "Stop Stimulus" is the largest stimulus (x-axis) value of the range.
- "Ripple Limit" is the maximum allowed difference between the largest and the smallest trace value in the range.

The ripple limit range is displayed as two parallel, horizontal lines in the diagram. "Stop Stimulus" - "Start Stimulus" is the length of both lines (if the range is within the sweep range); "Ripple Limit" is their vertical distance. See [Chapter 9.4.1.2, "Rules for Ripple Test Definition"](#), on page 234.

Remote command:

```
CALCulate<Chn>:RIPPLE:SEGMENT<Seg>[:STATE]
CALCulate<Chn>:RIPPLE:SEGMENT<Seg>:STIMULUS:START
CALCulate<Chn>:RIPPLE:SEGMENT<Seg>:STIMULUS:STOP
CALCulate<Chn>:RIPPLE:SEGMENT<Seg>:LIMIT
CALCulate<Chn>:RIPPLE:SEGMENT:COUNT?
```

Add / Insert / Delete / Delete All / Align All

The first four buttons below the range list extend, shorten, or reorder the list.

- "Add" adds a new range to the list. The new range is inserted after the previously selected range. The current range numbers are adapted; the start and stop stimulus values are set so that an overlap is avoided. Moreover, the ripple limit is estimated according to the measured ripple of the trace in the created range. The analyzer places no restriction on the number of ranges assigned to each trace.
- "Insert" adds a new range before the active range (marked by a blue background in the first column of the range list). The new range extends from the "Stop Stimulus" value of the range before the active range to the "Start Stimulus" value of the active

range. Its ripple limit is estimated according to the measured ripple of the trace in the created range. The range numbers in the list are adapted.

If no range is active, "Insert" is equivalent to "Add".

- "Delete" removes the selected range from the list.
- "Delete All" clears the entire range list so it is possible to define or load a new ripple limit line.
- "Align All" redefines existing sweep ranges such that they cover the overall sweep range and have (almost) equal width. The ripple limits are estimated according to the measured ripple of the trace in the created ranges.

Remote command:

```
CALCulate<Chn>:RIPple:CONtrol:DOMain
```

```
CALCulate<Chn>:RIPple:DATA
```

```
CALCulate<Chn>:RIPple:DElete:ALL
```

Recall Ripple Test.../Save Ripple Test...

The buttons open an Open/Save File dialog to load a ripple limit line from a ripple limit file or store the current ripple limit configuration to a file.

Ripple limit files are ASCII files with the default extension *.ripple and a special file format. See [Chapter 9.4.1.5, "File Format for Ripple Limits"](#), on page 238.

Remote command:

```
MMEMemory:LOAD:RIPple
```

```
MMEMemory:STORe:RIPple
```

10.9.6 Circle Test Tab

Defines circular limit lines for complex trace formats ("Polar", "Smith", "Inv Smith"), visualizes them in the diagram and activates/deactivates the circle limit check.

Most of the control elements in the "Circle Test" tab are disabled if the active trace has a cartesian format.



Background information

Refer to [Chapter 9.4.1.3, "Circle Limits"](#), on page 235.

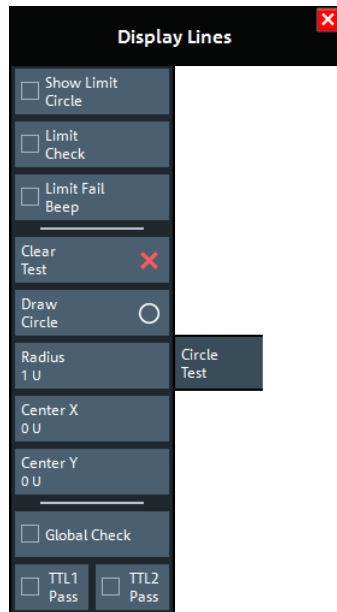

Show Limit Circle

Shows or hides the limit line associated with the active trace in a polar diagram area.

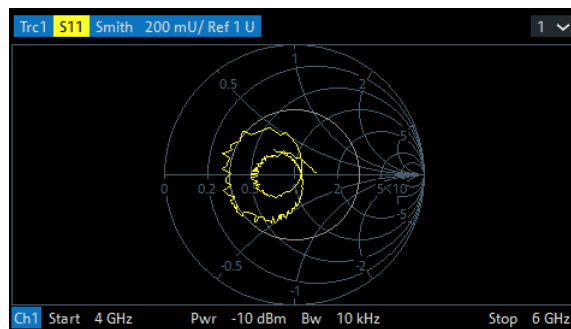

Note: Display of the limit line and limit check are independent of each other: Hiding the limit line does not switch off the limit check.

Remote command:

`CALCulate<Chn>:LIMit:CIRCle:DISPlay[:STATe]`

Limit Check

Switches the limit check of the active trace on or off.

When the limit check is switched on, a movable "PASS" or "FAIL" message is displayed in the diagram. If the limit check fails at a measurement point, the point is marked with a colored square. An acoustic signal ([Limit Fail Beep](#)) and a TTL signal indicating pass or fail can be generated in addition.

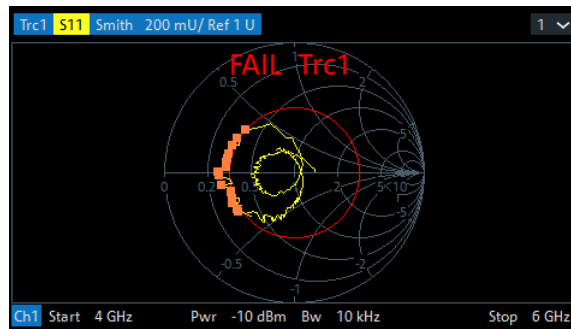
**Note:**

- Circle limit check and display of limit circles are independent of each other:
 - The limit circles can be displayed, no matter if the circle limit check is enabled.
 - If "Limit Check" is enabled, the ripple limits are checked, no matter if they are displayed.
- If result evaluation is limited to a user-defined [display circle](#), the [Chapter 10.9.6, "Circle Test Tab"](#), on page 424 is only performed inside this display circle.
- The circle limits can only be checked if the trace format is complex. While a cartesian format is active, the limit circles are hidden and the circle limit check is suspended.
- If the limit check for (cartesian) [limit lines](#) is enabled, it is also evaluated in complex diagrams.

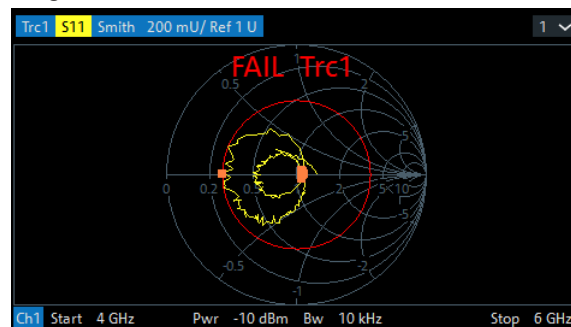

Figure 10-10: Simultaneous dB Mag limit line and circle check

Remote command:

```
CALCulate<Chn>:LIMit:CIRCle[:STATe]
```

```
CALCulate<Chn>:LIMit:CIRCle:FAIL?
```

```
CALCulate:LIMit:CIRCle:FAIL:ALL?
```

Limit Fail Beep

Activates or deactivates the fail beep. The fail beep is a low-tone acoustic signal that is generated each time the analyzer detects an exceeded limit. No fail beep can be generated if the limit check is switched off.

Note: The R&S ZNL/ZNLE does not have a built-in audio device and loudspeaker. To hear these sounds, connect a USB audio device to the instrument or operate it via remote desktop.

Remote command:

```
CALCulate<Chn>:LIMit:CIRCle:SOUNd[:STATe]
```

Clear Test

Resets the limit check results.

Remote command:

```
CALCulate<Chn>:LIMit:CIRClE:CLEar
```

Draw Circle

Activates touchscreen or mouse operation; tap the diagram at one border of the limit circle and draw the circle to the required size and position.

Remote command:

n/a

Radius / Center X / Center Y

Defines the limit circle by its radius and its center on the X-axis and Y-axis.

Remote command:

```
CALCulate<Chn>:LIMit:CIRClE:DATA
```

Global Check

See "[Global Check](#)" on page 414.

TTL1 Pass / TTL2 Pass

See "[TTL1 Pass / TTL2 Pass](#)" on page 414.

10.9.7 Display Circle Tab

The "Display Circle" functionality allows you to limit results in complex trace formats (Smith, Polar) to a user-defined circle. In particular, while the trace format is complex, line and circle limit checks are only performed inside the display circle.



Most of the controls on this tab are only active, if the active trace is displayed in a complex format.

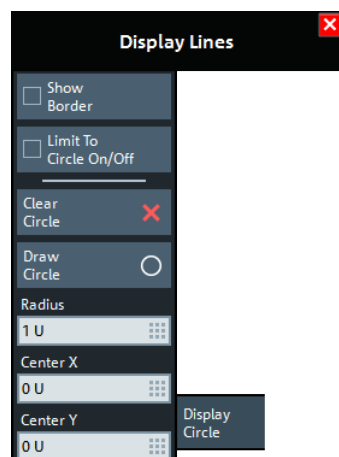

Show Border

If enabled, the border of the Display Circle is shown whenever the related trace is displayed in complex format.

Remote command:

```
CALCulate<Chn>:LIMit:DCIRcle:DISPlay[:STATe]
```

Limit to Circle On/Off

If enabled, only trace points within the configured "Display Circle" are shown, whenever the related trace is displayed in complex format. At the same time, the active limit tests (line, circle) are restricted to the configured "Display Circle".

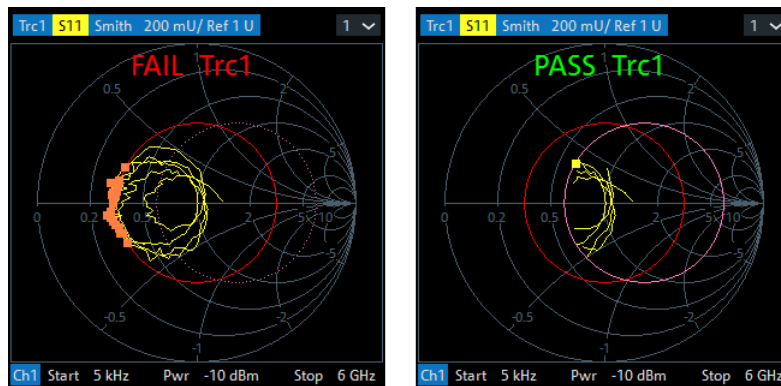

left ("FAIL") = "Circle Test" enabled, but not limited to "Display Circle"

right ("PASS") = "Circle Test" enabled, but limited to "Display Circle"

Remote command:

```
CALCulate<Chn>:LIMit:DCIRcle[:STATe]
```

Clear Circle

Resets the "Display Circle" to its default configuration (unit circle; show border: off; limit to circle: off)

Remote command:

```
CALCulate<Chn>:LIMit:DCIRcle:CLEAr
```

Draw Circle / Radius, Center X, Center Y

Defines the Display Circle – either by drawing it in the diagram area or by providing its radius and center.

Remote command:

```
CALCulate<Chn>:LIMit:DCIRcle:DATA
```

10.9.8 Horiz. Line Tab

Shows or hides a horizontal line associated to the active trace in a cartesian diagram area. The line can be moved to particular trace points to retrieve the response values. It also shows which parts of a trace are above or below a definite response value.



- The controls on this tab are only active if the active trace is displayed in cartesian format.
- If another trace format is selected, the line (position) is deleted.

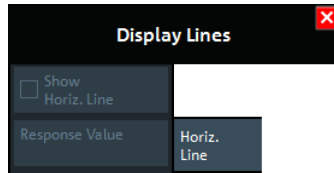

Show Horiz. Line

Displays or hides the horizontal line.

Remote command:

`CALCulate<Chn>:DLINe:STATe`

Response Value

Defines/shows the response value of the horizontal line.

Tip: Use the R&S ZNL/ZNLE's drag and drop functionality to move the horizontal line to a particular position. The response value appears in the numeric entry field.

Remote command:

`CALCulate<Chn>:DLINe`

10.10 Marker Settings Softtool

The "Marker Settings" are used to position markers on a trace and define their (display) properties.

Access: [Mkr]



Background information

See [Chapter 9.2.1.3, "Markers"](#), on page 199.

- [Markers Tab](#)..... 429
- [Marker Props Tab](#).....432
- [Set by Marker Tab](#).....434
- [Info Field Tab](#).....436
- [Marker Coupling Tab](#).....436

10.10.1 Markers Tab

Creates markers and configures their properties. Markers are available for all trace formats.

A first marker labeled "M1" is automatically created when the [Mkr] or [Mkr->] hardkey is pressed. The "Mkr 1" ... "Mkr 10" and "Ref Mkr" softkeys enable the corresponding markers.

"Add Marker" adds a new marker.



Related information

Refer to [Chapter 9.2.1.3, "Markers"](#), on page 199.

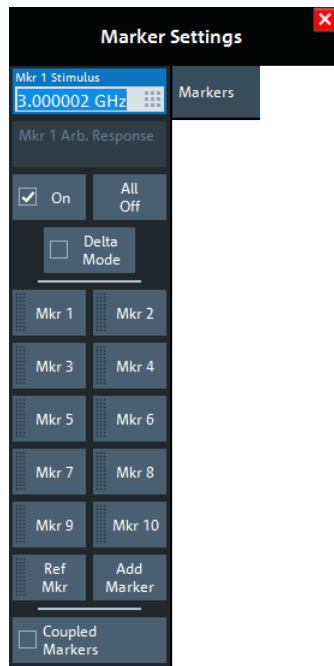

Mkr <i> Stimulus / Ref Mkr Stimulus

Gets/sets the stimulus value of the active marker.

Remote command:

`CALCulate<Chn>:MARKer<Mk>:X`

`CALCulate<Chn>:MARKer<Mk>:REference:X`

Mkr <i> Arb. Response / Ref Mkr Arb. Response

Gets/sets the response value (Y position) of an "Arbitrary" marker (see "[Marker Mode](#)" on page 433).

Remote command:

`CALCulate<Chn>:MARKer<Mk>:Y`

`CALCulate<Chn>:MARKer<Mk>:REference:Y`

On

Enables/disables the active marker.

Markers remember their "Marker Props" while disabled (see [Chapter 10.10.2, "Marker Props Tab"](#), on page 432). The marker properties are definitely lost when the associated trace is deleted.

Remote command:

```
CALCulate<Chn>:MARKer<Mk> [:STATe]
```

```
CALCulate<Chn>:MARKer<Mk>:REFerence [:STATe]
```

All Off

Disables all markers of the active trace.

Markers remember their "Marker Props" while disabled (see [Chapter 10.10.2, "Marker Props Tab"](#), on page 432). The marker properties are definitely lost when the associated trace is deleted.

Tip: To disable a single marker, drag it into vertical direction to release it from the trace and drop it onto the "Delete" icon.

Remote command:

```
CALCulate<Chn>:MARKer<Mk>:AOFF
```

Delta Mode

Enables/disables the "Delta Mode" for the active marker. At the same time, enables the [Ref Mkr](#).

This function is inactive if the reference marker is the active marker.

Remote command:

```
CALCulate<Chn>:MARKer<Mk>:DELTA [:STATe]
```

Mkr 1 ... Mkr 10

Creates the markers numbered 1 to 10 and assigns them to the active trace. When a marker is created, a triangle labeled "M<i>" is positioned on the trace and the marker coordinates are displayed in the movable info field.

The stimulus position of an active marker can be entered in the "Mkr <i> Stimulus" entry field. The default position is the center of the sweep range. You can also drag and drop markers in a diagram to change their X position.

If the [Marker Mode](#) is "Arbitrary", also the response value (Y position) can be changed.

See also "[Activating and Moving Markers](#)" on page 200.

Remote command:

```
CALCulate<Chn>:MARKer<Mk> [:STATe]
```

```
CALCulate<Chn>:MARKer<Mk>:Y
```

```
CALCulate<Chn>:MARKer [:STATe] :AREA
```

Ref Mkr

Creates a reference marker and assigns it to the active trace. When a marker is created, a triangle labeled "R" is positioned on the trace and the marker coordinates are displayed in the info field.

The stimulus position of the active reference marker can be entered in the "Ref Marker Stimulus" entry field. The default position is the start of the sweep range or the position of the last active marker.

The reference marker defines the reference value for all markers that are in "Delta Mode".

Remote command:

```
CALCulate<Chn>:MARKer<Mk>:REFerence[:STATe]
```

```
CALCulate<Chn>:MARKer<Mk>:REFerence:Y
```

Add Marker

Adds a new marker to the active trace. Uses the next "free" marker number

Coupled Markers

Activates or deactivates [Marker Coupling](#). The label indicates the selected [Coupling Type](#):

"Coupling Type"	Label
"All"	"Coupled Markers"
"Channel"	"Coupled Markers in <name of active channel>"
"Diagram"	"Coupled Markers in <name of active diagram>"

Coupling also works if [Tracking](#) is enabled for *Marker <m>* in **one** trace. The *Marker <m>* of the other traces then follow the movements of the tracked marker. The same holds true for the reference marker.

Remote command:

```
CALCulate:MARKer:COUPled[:STATe]
```

10.10.2 Marker Props Tab

Modifies the properties of a marker created previously (see [Chapter 10.10.1, "Markers Tab"](#), on page 429). The functions (except "Export Markers...") are unavailable if the active trace contains no markers.

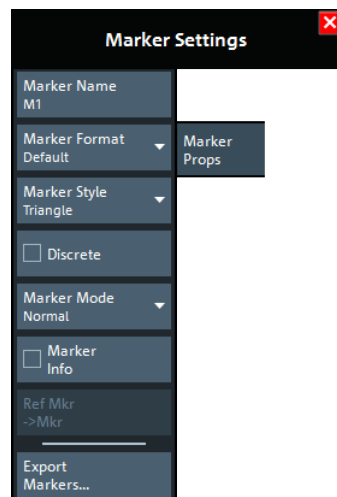

Marker Name

Assigns a (new) name to the active marker. Marker names can contain letters, numbers, blanks and special characters.

Remote command:

```
CALCulate<Chn>:MARKer<Mk>:NAME
```

```
CALCulate<Chn>:MARKer<Mk>:REFerence:NAME
```

Marker Format

Defines the formatting of the active marker in the movable marker info field.

For background information on marker formats, see "[Marker Format](#)" on page 201.

"Default" means that the marker is formatted according to the related trace's [Dflt Marker Frmt](#).

In "Arbitrary" [Marker Mode](#), if the transformation between trace format and marker format requires a concrete stimulus value, some result values in the marker info field can be unavailable. Those values are displayed as a sequence of dashes (-----).

Remote command:

```
CALCulate<Chn>:MARKer<Mk>:FORMat
```

```
CALCulate<Chn>:MARKer<Mk>:REFerence:FORMat
```

Marker Style

Defines how the selected marker is displayed on the screen.

Remote command:

n/a

Discrete

Discrete mode means that a marker can be set to discrete sweep points only. If discrete mode is switched off, the marker can be positioned on any point of the trace, and its response values are obtained by interpolation.

Remote command:

```
CALCulate<Chn>:MARKer<Mk>:MODE
```

```
CALCulate<Chn>:MARKer<Mk>:REFerence:MODE
```

Marker Mode

Determines if and how the marker's position is adjusted and if and how it can be moved in the diagram area.

Normal: If [Tracking](#) is enabled, the marker's stimulus value is updated automatically with every sweep, otherwise it is constant. The marker position is adjusted to the corresponding response value, i.e. the marker is always positioned on the trace.

If in the current trace format the X axis represents the stimulus, the marker can be moved horizontally. At the same time, the marker's stimulus and response values are adjusted, i.e. its vertical position automatically follows the trace.

Fixed: freezes the marker at the position determined by the current stimulus and response value. Tracking is disabled. The stimulus and response values are stored with the marker; they are not adjusted to subsequent sweeps or trace format changes.

If in the current trace format the X axis represents the stimulus, the marker can be moved horizontally. Moving the marker adjusts the markers's stimulus value, but its response value remains fixed.

Arbitrary: freezes the marker at the position determined by the current stimulus and response value. Tracking is disabled. The marker stores the stimulus value and – in addition – its X and Y coordinates in the current [Marker Format](#).

The marker can be moved freely inside the diagram, directly adjusting its X and Y coordinates. If in the current trace format the X axis represents the stimulus, the marker's stimulus value is adjusted accordingly. Otherwise the marker's stimulus value remains unchanged and is not shown in the [Marker Info Field](#). Switching between trace formats resets the marker position to the response value at the marker's stimulus value, i.e. the marker snaps to the trace.

Remote command:

```
CALCulate<Chn>:MARKer<Mk>:TYPE
```

```
CALCulate<Chn>:MARKer<Mk>:REFerence:TYPE
```

Marker Info

Displays the marker coordinates above the marker symbol.

Remote command:

n/a

Ref Mkr -> Mkr

Places the reference marker to the position of the active marker. "Ref. Mkr -> Mkr" is not active if the active marker is a reference marker.

Remote command:

n/a

Export Markers

Calls up a "Save As"... dialog to store the current marker values to a marker file.

The analyzer uses a simple ASCII format to export marker values. By default, the marker file extension is *.txt. The file contains all traces in the active channel setup together with their names and measured quantities. Below each trace, the file shows a list of all markers with their names, stimulus and response values.

The following example of a marker file describes a channel setup with two traces, "Trc1" and its memory trace "Mem2[Trc1]". "Trc1" has a reference marker "R" and three normal markers "M1, M2, M3" assigned, the memory trace has no markers.

```
Trc1 S21
R 869.01766 MHz -4.751 dB
M1 5.621400 GHz 1.351 dB
M2 3.380996 GHz -6.043 dB
M3 1.928122 GHz -4.700 dB

Mem2[Trc1] S21
No Markers
```

Remote command:

```
MMEMory:STORe:MARKer
```

10.10.3 Set by Marker Tab

The "Set by Marker" functions use the active marker to define the sweep range, scale the diagram and introduce an electrical length offset. The functions are unavailable if the active trace contains no markers (e.g. after "All Markers Off").

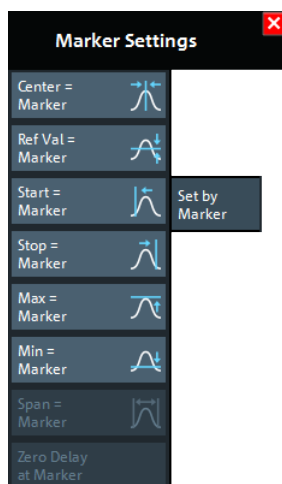

Center = Marker / Start = Marker / Stop = Marker / Span = Marker

The following functions use the stimulus value of the active marker to define the sweep range.

- "Center = Marker" sets the center of the sweep range equal to the stimulus value of the active marker, leaving the span unchanged. The active marker appears in the center of the diagram.
- "Start = Marker" sets the beginning (start) of the sweep range equal to the stimulus value of the active marker, leaving the end (stop) value unchanged. The active marker appears at the left edge of the diagram.
- "Stop = Marker" sets the end (stop) of the sweep range equal to the stimulus value of the active marker, leaving the beginning (start) unchanged. The active marker appears at the right edge of the diagram.
- "Span = Marker" is only available for frequency sweeps (linear or logarithmic). It is enabled if the active marker is in [Delta Mode](#). "Span = Marker" adjusts the sweep span to the range between the active delta marker and the reference marker.

Remote command:

```
CALCulate<Chn>:MARKer<Mk>:FUNction:CENTer
```

```
CALCulate<Chn>:MARKer<Mk>:FUNction:START
```

```
CALCulate<Chn>:MARKer<Mk>:FUNction:STOP
```

```
CALCulate<Chn>:MARKer<Mk>:FUNction:SPAN
```

Ref Val = Marker / Max = Marker / Min = Marker

The following functions use the response value of the active marker to scale the y-axis of the diagram:

- "Ref Val = Marker" sets the reference value equal to the response value of the active marker, leaving the values of the vertical divisions ("Scale / Div") unchanged.
- "Max = Marker" sets the upper edge of the diagram equal to the response value of the active marker, leaving the values of the vertical divisions ("Scale / Div") unchanged.
- "Min = Marker" sets the lower edge of the diagram equal to the response value of the active marker, leaving the values of the vertical divisions ("Scale / Div") unchanged.

Remote command:

n/a

Zero Delay at Marker

This function is available for [Delay](#) traces only. It shifts the trace in vertical direction so that the delay at the marker position becomes zero. Mathematically, it modifies the measurement results by subtracting the delay at the current marker position.

The delay represents the propagation time of the wave. Hence "Zero Delay at Marker" performs an electrical length compensation, by adding or subtracting a simulated lossless transmission line of variable length to or from the test port. This shift of the reference plane must be carried out on the "Delay" trace, but has an impact on all trace formats.

A standard application of "Zero Delay at Marker" is correction of the constant delay caused by the interconnecting cables between the analyzer test ports and the DUT (line stretch).

Note: "Zero Delay at Marker" modifies the "Offset" parameters and therefore influences the entire channel.

Remote command:
n/a

10.10.4 Info Field Tab

Displays or hides the marker info field and selects its contents. The functions are self-explanatory.

**Background information**

Refer to "[Marker Info Field](#)" on page 200

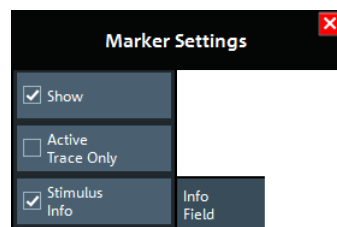
**10.10.5 Marker Coupling Tab**

Allows you to set up and control marker coupling.

**Background information**

Refer to "[Marker Coupling](#)" on page 203.

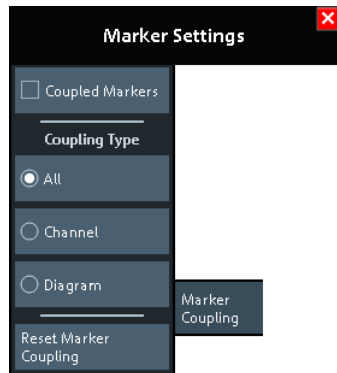

Coupled Markers

Activates or deactivates [Marker Coupling](#). The label indicates the selected [Coupling Type](#):

"Coupling Type"	Label
"All"	"Coupled Markers"
"Channel"	"Coupled Markers in <name of active channel>"
"Diagram"	"Coupled Markers in <name of active diagram>"

Coupling also works if [Tracking](#) is enabled for *Marker <m>* in **one** trace. The *Marker <m>* of the other traces then follow the movements of the tracked marker. The same holds true for the reference marker.

Remote command:

```
CALCulate:MARKer:COUPled[:STATe]
```

Coupling Type

Determines the set of traces whose markers are coupled to the markers of the active trace when [marker coupling](#) is enabled.

- **"All"**: marker coupling applies to all traces in the active channel setup that have the same stimulus variable as the active trace
- **"Channel"**: marker coupling applies to all traces in the active channel
- **"Diagram"**: marker coupling applies to all traces in the active diagram that have the same stimulus variable as the active trace

The selected "Coupling Type" applies to all marker coupling relations in the current channel setup. Changing the "Coupling Type" automatically disables marker coupling throughout the channel setup.

Remote command:

```
CALCulate:MARKer:COUPled:TYPE
```

Reset Marker Coupling

Convenience function for disabling [marker coupling](#) and setting the [Coupling Type](#) to "All" (default).

Remote command:

```
CALCulate:MARKer:COUPled[:STATe] OFF
CALCulate:MARKer:COUPled:TYPE ALL
```

10.11 Marker Search Softtool

The "Marker Search" softtool provides functions for searching and tracking special points on traces.

Access: [Mkr->] hardkey



Background information

See [Chapter 9.2.1, "Display Elements of a VNA Diagram"](#), on page 196.

- [Peak Tab](#)..... 438
- [Multiple Peak Tab](#)..... 443
- [Target Search Tab](#)..... 445
- [Bandfilter Tab](#)..... 447

10.11.1 Peak Tab

Provides "Marker Search" functions that move the active marker to a (local) maximum or minimum of the active trace.

The search operation can be restricted to a configurable range of stimulus values ("Search Range..."). By default, the search range is equal to the entire sweep range.

If necessary, the active marker is enabled to indicate the search result.



Background information

Refer to "[Basic Marker Search Functions](#)" on page 204.

10.11.1.1 Controls on the Peak Tab

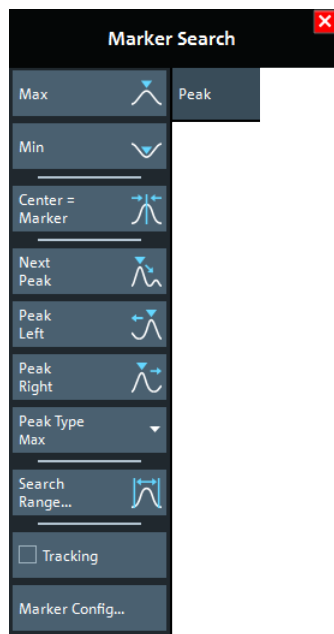

Max / Min

Sets the active marker to the absolute maximum or minimum in the search range, i.e. to the largest or smallest of all response values. If a complex trace format (e.g. a polar diagram) is active, the marker is set to the measurement point with the maximum or minimum magnitude.

"Max" and "Min" also overwrite the current "Search Mode" (--> "Search Min" and "Search Max") and the "Peak Type" for the peak search functions.

Remote command:

```
CALCulate<Chn>:MARKer<Mk>:FUNction:EXECute MINimum | MAXimum
CALCulate<Chn>:MARKer<Mk>:FUNction:RESult?
```

Center = Marker

See "[Center = Marker / Start = Marker / Stop = Marker / Span = Marker](#)" on page 435.

Next Peak

Sets the active marker to the next local maximum or minimum in the search range, depending on the selected [Peak Type](#).

Remote command:

```
CALCulate<Chn>:MARKer<Mk>:FUNction:EXECute NPEak
CALCulate<Chn>:MARKer<Mk>:FUNction:RESult?
```

Peak Left / Peak Right

Sets the active marker to the next local maximum or minimum to the left or right of the current marker position, depending on the selected [Peak Type](#).

Remote command:

```
CALCulate<Chn>:MARKer<Mk>:FUNction:EXECute LPEak | RPEak
CALCulate<Chn>:MARKer<Mk>:FUNction:RESult?
```

Peak Type

Defines the peak type to be searched for using [Next Peak](#) and "Next Peak", [Peak Left / Peak Right](#):

- If "Max" is active, then the marker is set to the next maximum. The next maximum is the maximum with the largest response value that is below the current marker response value.
- If "Min" is active, then the marker is set to the next minimum. The next minimum is the minimum with the smallest response value that is above the current marker response value.
- If "Min or Max" is active, then the marker is set to the next minimum or maximum, whichever has the smallest distance from the current marker response value.

Remote command:

```
CALCulate<Chn>:MARKer<Mk>:FUNction:EXECute LPEak | RPEak
```

Search Range...

Opens the [Search Range Dialog](#).

Tracking

Enables/disables tracking of the active marker for the current [Search Mode](#), which causes the marker to be updated after each sweep (or after each sweep point in case of "Sweep Progress").

Among the available search modes, the tracking functionality only makes sense for:

- "Min" and "Max", where such an update typically causes the marker to change both its horizontal and vertical position and
- "Target Search", where typically only the horizontal position changes
- "Sweep Progress" for long duration sweeps

Define an adequate "Search Range" to restrict the search to the adequate frequency or power interval (see [Chapter 10.11.1.2, "Search Range Dialog"](#), on page 440).

Note: Tracking for bandfilter search can be activated separately, see ["Tracking"](#) on page 451.

Remote command:

```
CALCulate<Chn>:MARKer<Mk>:SEARch:TRACking
```

Marker Config...

Opens the [Marker Config Dialog](#).

10.11.1.2 Search Range Dialog

The "Search Range" dialog confines the "Peak" and "Target Search" for the selected marker to a subrange of the sweep. The search range is a continuous interval of the sweep variable.

Access: [Mkr->] > "Peak" > "Search Range..."

If [Tracking](#) is active, the assigned "Search Range" applies to all sweeps and can be used to achieve uniqueness in "Min", "Max" or "Target Search".

See also [Chapter 10.6.8, "Trace Statistics Tab"](#), on page 359.

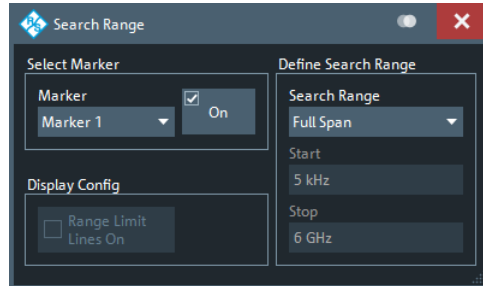

It is possible to define search ranges for each channel setup and assign them to the corresponding markers and the reference marker.

Select Marker

Selects the reference marker or one of the numbered markers that can be assigned to the trace. If a numbered marker does not exist, it is created when "On" is checked. A created marker is displayed in the center of the search range.

Search Range

Selects the "Search Range" to be assigned to the selected marker. "Full Span" means that the "Search Range" is equal to the sweep range. Besides, it is possible to store up to 10 customized search ranges.

The "Search Range"s are bordered by the "Start" and "Stop" values. "Start" must be smaller than "Stop", otherwise the second value is automatically adjusted.

"Search Range" properties

The 10 search ranges are valid for the entire channel setup. Each of them can be assigned to any marker in the channel setup, irrespective of the trace and channel that the marker belongs to.

The default search range of any new marker is "Full Span". The analyzer provides the greatest flexibility in defining search ranges. In particular, two search ranges can overlap or even be identical. The search is confined to the part of the search range that belongs to the sweep range.

The following example shows how "Search Range"s can be used to search a trace for several local maxima.

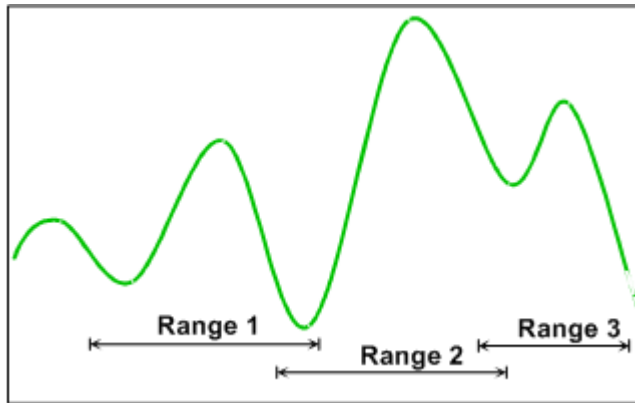

Note: The marker Evaluation Ranges are identical to the evaluation ranges for trace statistics. For more information, see [Chapter 10.6.8.2, "Evaluation Range Dialog"](#), on page 362.

Remote command:

```
CALCulate<Chn>:MARKer<Mk>:FUNction:DOMain:USER[:RANGE]
CALCulate<Chn>:MARKer<Mk>:FUNction:DOMain:USER:START
CALCulate<Chn>:MARKer<Mk>:FUNction:DOMain:USER:STOP
```

Range Limit Lines On

Displays or hides the range limit lines in the diagram area. Range limit lines are two vertical lines at the Start and Stop values of the active search range ("Range 1" to "Range 10").

Remote command:

```
CALCulate<Chn>:MARKer<Mk>:FUNction:DOMain:USER:SHOW
```

10.11.1.3 Marker Config Dialog

The "Marker Config" dialog allows you to configure the peak searches for the active trace and all its markers.

Access:

- [Mkr->] > "Peak" > "Marker Config..."
- [Mkr->] > "Multiple Peak" > "Marker Config..."

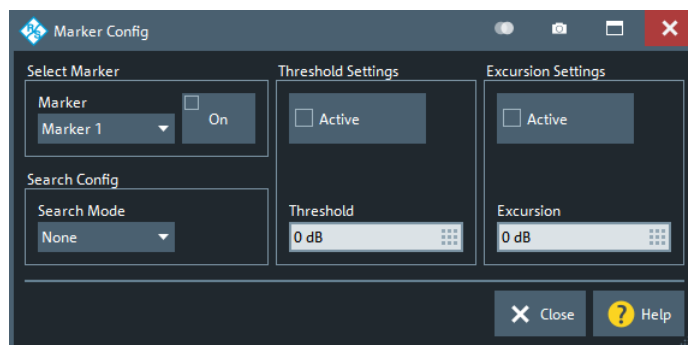

Select Marker

Allows you to select the related marker and to activate or deactivate it.

Remote command:

```
CALCulate<Chn>:MARKer<Mk>[:STATe]
```

Search Config

Allows you to select the [Target Search Mode](#) of the selected marker.

Remote command:

```
CALCulate<Chn>:MARKer<Mk>:FUNction:EXECute
```

Threshold Settings

Defines a threshold for (single) peak searches and activates it.

If "Active", only maxima above and minima below the configured "Threshold" are considered.

The unit is derived from the active trace format and cannot be modified. Changing the trace format resets the "Threshold" to a format-specific default value.

Remote command:

```
CALCulate<Chn>:MARKer<Mk>:THReshold  
CALCulate<Chn>:MARKer<Mk>:THReshold:STATe
```

Excursion Settings

Defines a minimum excursion for peak searches and activates it.

If "Active", only peaks with an excursion above the configured "Excursion" value are considered. By definition, the excursion of a peak is the smaller of the absolute differences in measured values from the adjoining peaks of opposite polarity.

The unit is derived from the active trace format and cannot be modified. Changing the trace format resets the "Excursion" to a format-specific default value.

Remote command:

```
CALCulate<Chn>:MARKer<Mk>:EXCursion  
CALCulate<Chn>:MARKer<Mk>:EXCursion:STATe
```

10.11.2 Multiple Peak Tab

"Multiple Peak" search allows you to find multiple local minima/maxima at once.

**Background information**

Refer to "[Basic Marker Search Functions](#)" on page 204.

10.11.2.1 Controls on the Multiple Peak Tab

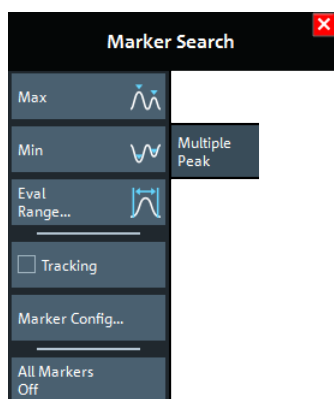

Max / Min

Sets up to 10 markers to the highest maxima or lowest minima in the configured [Eval Range](#). If a complex trace format is active (e.g. a polar diagram), the markers are set to the measurement points with the maximum or minimum magnitude.

The required markers are created/deleted as needed.

Remote command:

```
CALCulate<Chn>:MARKer<Mk>:FUNction:EXECute MMAXimum | MMINimum
CALCulate<Chn>:MARKer<Mk>:FUNction:RESult?
```

Eval Range

Opens the [Evaluation Range Dialog](#) that allows you to set the domain for the multiple peak search. A modified domain takes effect the next time [Max / Min](#) is used.

Tracking

Enables or disables tracking for "Multiple Peak" search. If enabled, a new multiple peak search is performed for each sweep (creating/deleting markers as needed).

Define an [Eval Range](#) to restrict the search to the adequate frequency or power interval.

Remote command:

```
CALCulate<Chn>:MARKer<Mk>:SEARch:TRACking
```

Marker Config...

Opens the [Multiple Marker Config Dialog](#).

All Markers Off

See ["All Off"](#) on page 431.

10.11.2.2 Multiple Marker Config Dialog

The "Multiple Marker Config" dialog allows you to configure the multiple peak searches for the active trace.

Access: [Mkr->] > "Multiple Peak" > "Marker Config..."

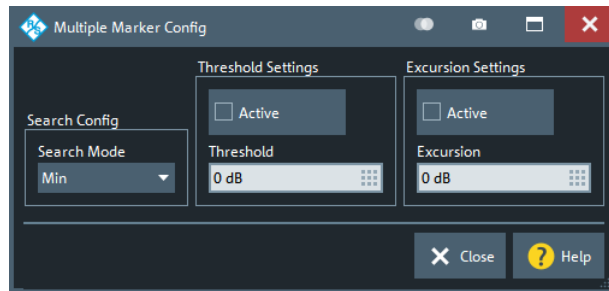

Search Config

Same as selecting [Max / Min](#).

Remote command:

```
CALCulate<Chn>:MARKer<Mk>:FUNction:EXECute MMAXimum | MMINimum
```

Threshold Settings

Defines a threshold for multiple peak searches and activates it.

If "Active", only maxima above and minima below the configured "Threshold" are considered.

The unit is derived from the active trace format and cannot be modified. Changing the trace format resets the "Threshold" to a format-specific default value.

Remote command:

```
CALCulate<Chn>:MARKer:MPEak:THReshold
CALCulate<Chn>:MARKer:MPEak:THReshold:STATe
```

Excursion Settings

Defines a minimum excursion for multiple peak searches and activates it.

If "Active", only peaks with an excursion above the configured "Excursion" value are considered. By definition, the excursion of a peak is the smaller of the absolute differences in measured values from the adjoining peaks of opposite polarity.

The unit is derived from the active trace format and cannot be modified. Changing the trace format resets the "Excursion" to a format-specific default value.

Remote command:

```
CALCulate<Chn>:MARKer:MPEak:EXCursion
CALCulate<Chn>:MARKer:MPEak:EXCursion:STATe
```

10.11.3 Target Search Tab

The "Target Search" functions use markers to locate trace points with a specific response value ("Target Value"). The functions are unavailable if the active trace contains no markers (e.g. after "All Markers Off").

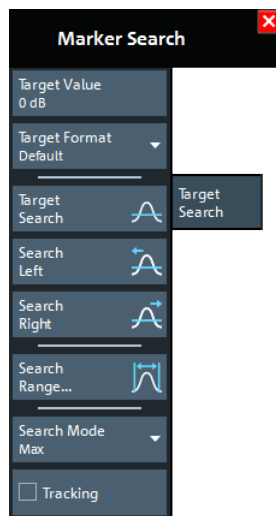

Some of the "Target Search" functions are equal to other marker search functions. Refer to the following sections:

- [Chapter 10.11.1.2, "Search Range Dialog"](#), on page 440
- ["Tracking"](#) on page 440

Target Value

Specifies the target value for the search.

The VNA software allows you to specify the target value in different formats (see [Target Format](#) below). For example, you can search for a particular phase value in a Smith chart.

Remote command:

`CALCulate<Chn>:MARKer<Mk>:TARGet`

Target Format

Selects the format that is used to specify the [Target Value](#).

The selected target format applies to the current marker only: each marker can have a different target format. The table below gives an overview on how a complex target value $z = x + jy$ is converted.

Target Format	Description	Formula
"Lin Mag"	Magnitude of z , unconverted.	$ z = \sqrt{x^2 + y^2}$
"dB Mag"	Magnitude of z [dB]	$\text{Mag}(z) = 20 \log z \text{ dB}$
"Phase"	Phase of z [°]	$\varphi(z) = \arctan(y/x)$
"Phase unwrap"	Unwrapped phase of z comprising the complete number of 360° phase rotations [°]	$\Phi(z) = \varphi(z) + 2k \cdot 360^\circ$
"Real"	Real part of z	$\text{Re}(z) = x$
"Imag"	Imaginary part of z	$\text{Im}(z) = y$

Target Format	Description	Formula
"SWR"	(Voltage) Standing Wave Ratio	$SWR = (1 + z) / (1 - z)$
"Default"	Identical to trace format. Note: the Smith and Polar traces use "Lin Mag" as the default format for target value.	-

Remote command:

```
CALCulate<Chn>:MARKer<Mk>:SEARch:FORMat
```

Target Search

Activates the search and sets the active marker to the defined target value. If the target value occurs at several stimulus values, the marker is placed to the search result with the smallest stimulus value. The other measurement points with the same target value can be located using the "Search Right" function.

If the target is not found (e.g. because the active trace does not contain the target value), then the active marker is not moved away from its original position.

Remote command:

```
CALCulate<Chn>:MARKer<Mk>:FUNction:EXECute TARGet  
CALCulate<Chn>:MARKer<Mk>:FUNction:RESult?
```

Search Left/Search Right

Searches the [Target Value](#) to the left/right of the active marker's stimulus value within the current search range (see [Chapter 10.11.1.2, "Search Range Dialog"](#), on page 440).

If the search is successful, the active marker is moved to the next smaller/larger stimulus value with this target value. Use "Search Left"/"Search Right" repeatedly to locate the other ones.

Remote command:

```
CALCulate<Chn>:MARKer<Mk>:FUNction:EXECute LTARGet  
CALCulate<Chn>:MARKer<Mk>:FUNction:RESult?
```

Search Mode

Displays and sets the current marker search mode.

Select one of the predefined max, min, peak, or target searches or select "Sweep Progress" to track the position of the sweep cursor.

Remote command:

```
CALCulate<Chn>:MARKer<Mk>:FUNction:EXECute
```

10.11.4 Bandfilter Tab

"Bandfilter" search allows you to search for trace segments with a bandpass or band-stop shape, and determine characteristic filter parameters.



Background information

Refer to "[Bandfilter Search](#)" on page 204.

Bandfilter for arbitrary scalar traces

"Bandfilter" search can be used for a broad range of measured quantities (see [Chapter 10.7, "Meas Softtool"](#), on page 375). To obtain real filter parameters, the trace format must be "dB Mag", the measured quantity must be a transmission S-parameter and a frequency sweep must be performed. However, for other formats, measured quantities or sweep types, the "Bandfilter" functions can still be useful to analyze general trace properties.

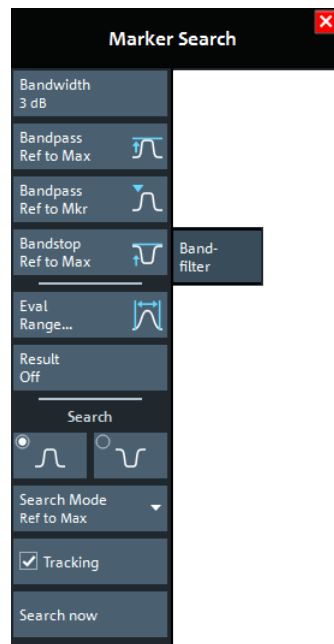

The "Eval Range..." button opens the "Evaluation Range" dialog that allows you to narrow the "Bandfilter" search to a particular stimulus range. See [Evaluation Range Dialog](#).

Bandwidth

Specifies the minimum excursion of the bandpass and bandstop peaks.

- A bandpass peak must fall off on both sides by the specified <Bandwidth> value to be considered a valid peak.
- A bandstop peak must be <Bandwidth> below the maximum level in the search range (bandpass value) to be considered a valid peak.

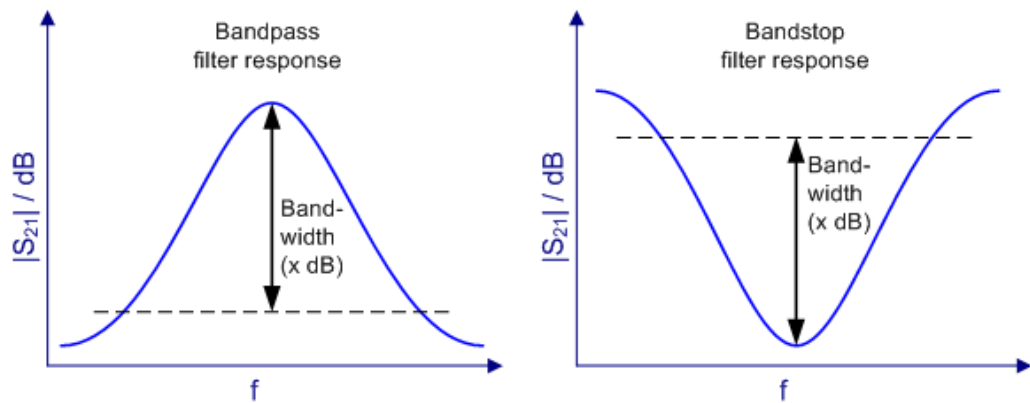

Remote command:

`CALCulate<Chn>:MARKer<Mk>:BWIDth`

Bandpass Ref to Max

Activates the search for a bandpass region on the active trace and activates [Tracking](#). The located bandpass region is the tallest peak in the search range with a minimum excursion as specified by the "Bandwidth" parameter.

If "Bandpass Ref to Max" is selected, the analyzer uses (or creates) the four markers "M1" to "M4" to locate the **bandpass region**.

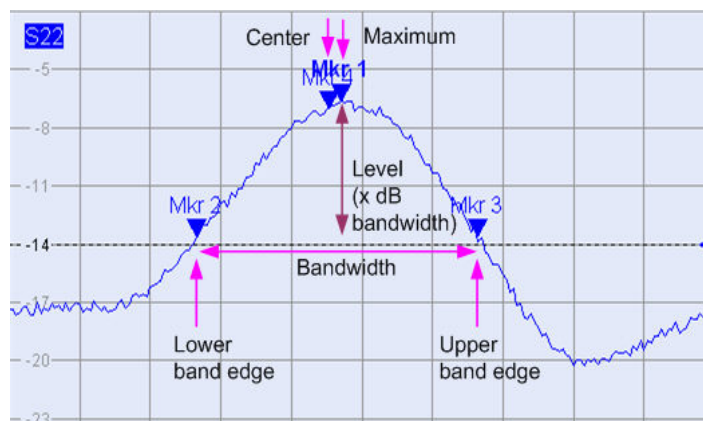

- "M1" indicates the maximum of the peak ("Max").
- "M2" indicates the point on the left edge of the peak where the trace value is equal to the maximum minus the bandwidth factor ("Lower Edge").
- "M3" indicates the point on the right edge of the peak where the trace value is equal to the maximum minus the bandwidth factor ("Upper Edge").
- "M4" indicates the center of the peak. Depending on a system setting, the center is either calculated as the geometric or the arithmetic mean of the "Lower Edge" and "Upper Edge" frequencies (see ["Geometric Calculation of Bandfilter Center"](#) on page 145).

The search results are displayed in the movable "Bandfilter" info field.

Remote command:

```
CALCulate<Chn>:MARKer<Mk>:FUNCTION:BWIDth:MODE BPASs
CALCulate<Chn>:MARKer<Mk>:FUNCTION:EXECute BFILter
CALCulate<Chn>:MARKer:SEARch:BFILter:RESult[:STATe]:AREA
```

Bandpass Ref to Mkr

Activates the search for a bandpass region on the active trace and activates [Tracking](#), starting at the position of the active marker. A bandpass region is the closest peak in the evaluation range that has a minimum excursion as specified by the "Bandwidth" parameter.

In contrast to a "Bandpass Ref to Max", the "Bandpass Ref to Mkr" does not change the position of the active markers. The search results are displayed in the movable "Bandfilter" info field.

Remote command:

```
CALCulate<Chn>:MARKer<Mk>:FUNCTION:BWIDth:MODE BPRMarker
CALCulate<Chn>:MARKer<Mk>:FUNCTION:EXECute BFILter
```

Bandstop Ref to Max

Activates the search for a bandstop region on the active trace and activates [Tracking](#). A bandstop region is the lowest peak (local minimum) in the search range, whose level is at least <Bandwidth> below the maximum (passband value).

If "Bandstop Ref to Max" is selected, the analyzer uses (or creates) the four markers "M1" to "M4" to locate the **bandstop region**.

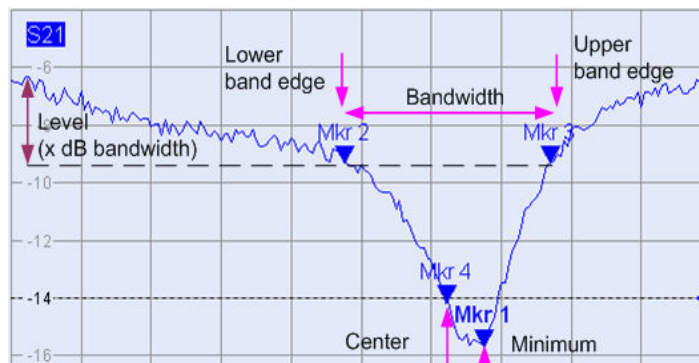

- "M1" indicates the minimum of the peak ("Min").
- "M2" indicates the "Lower Edge" of the bandstop, i.e. the point on the left edge of the peak where the trace value is equal to the maximum in the search range (passband value) minus the specified [Bandwidth](#).
- "M3" indicates the "Upper Edge" of the bandstop, i.e. the point on the right edge of the peak where the trace value is equal to the maximum in the search range (passband value) minus the specified "Bandwidth".
- "M4" indicates the center of the peak. Depending on a system setting, the center is either calculated as the geometric or the arithmetic mean of the "Lower Edge" and "Upper Edge" positions (see ["Geometric Calculation of Bandfilter Center"](#) on page 145).

The search results are displayed in the movable "Bandfilter" info field.

Remote command:

```
CALCulate<Chn>:MARKer<Mk>:FUNction:BWIDth:MODE BStOp
CALCulate<Chn>:MARKer<Mk>:FUNction:EXECute BFILter
```

Result Off

Hides the movable info field with the results of a bandpass or a bandstop search and disables [Tracking](#). The info field is displayed again (and tracking re-enabled) when a new "Bandfilter" search is performed.

Remote command:

```
CALCulate<Chn>:MARKer:SEARch:BFILter:RESult[:STATe]
```

Search (Bandpass or Bandstop) / Search Mode

Enables a bandpass or bandstop search (left/right icon) for an arbitrary search mode. The search modes have the following effect:

- "Ref to Max": The bandpass (bandstop) is the tallest (lowest peak) in the search range. For a detailed description, refer to ["Bandpass Ref to Max"](#) on page 449 and ["Bandstop Ref to Max"](#) on page 450.
- "Ref to Marker": The bandpass (bandstop) is the tallest (lowest) peak in the search range. The response value for the lower and upper band edges is calculated as the response value at the active marker position plus (minus) the [Bandwidth](#). To be valid, the peak must be above (below) the response value for the band edges.
- "Absolute Level:" The bandpass (bandstop) is the tallest (lowest) peak in the search range. To be valid, the peak must be above (below) -"Bandwidth". The Lower Band Edge and Upper Band Edge values are given by the frequencies where the trace is equal to -"Bandwidth".
- "None": "Bandfilter" search switched off, result off.

Remote command:

```
CALCulate<Chn>:MARKer<Mk>:FUNction:BWIDth:MODE
```

Tracking

Causes the active "Bandfilter" search to be repeated after each sweep: When tracking mode is active, the markers typically change their horizontal and vertical positions as the measurement proceeds.

Tracking mode properties

Tracking modes are available for all search modes. The tracking modes for minimum/maximum/peak search and target search are coupled; tracking for "Bandfilter" search can be activated separately. Tracking is activated automatically when one of the "Bandfilter" search modes is selected.

Remote command:

"Bandfilter" tracking and marker/target search tracking are controlled with the same command:

```
CALCulate<Chn>:MARKer<Mk>:SEARch:TRACking
```

10.12 Cal Softtool

The "Cal" softtool with its single "Calibration" tab provides all functions related to system error calibration.

Access: [Cal]

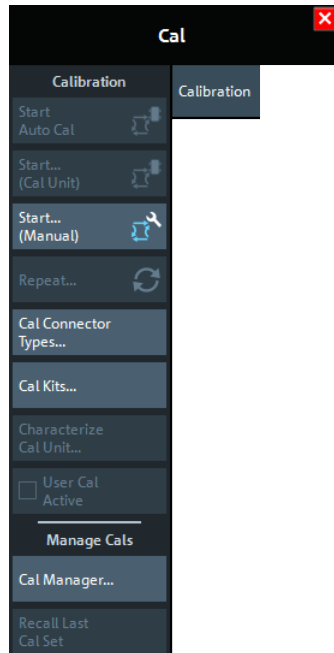

10.12.1 Create a User Calibration



Background information

Refer to the following sections:

- [Chapter 9.5, "Calibration"](#), on page 248
- [Chapter 9.5.5, "Automatic Calibration"](#), on page 260

10.12.1.1 Related Controls on the Calibration Tab

The upper part of the "Calibration" tab provides access to all functions for automatic or manual calibration. Calibration of the R&S ZNL/ZNLE is a fully guided process.

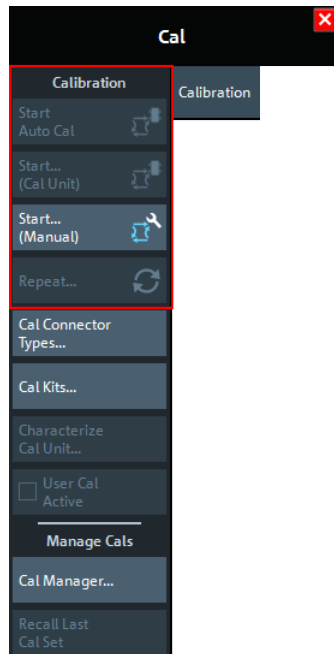

The "Start Auto Cal" and "Start... (Cal Unit)" buttons are only active if a calibration unit is connected to the analyzer.

Start Auto Cal

Performs a fully automatic system error calibration for the active channel, using the active calibration unit with its factory calibration and auto-detection of ports.

If one port is active, an OSM calibration is performed. If two ports are active, an UOSM calibration is performed.

Calibration – Start... (Cal Unit)

Opens the [Calibration Unit Wizard](#).

Calibration – Start... (Manual)

Opens the [Calibration Setting Wizard](#).

Calibration – Repeat...

Re-enters the data acquisition step of the current calibration, restoring the related channel settings. This provides a convenient way to repeat or correct an existing calibration without necessarily repeating all measurements.

10.12.1.2 Channel Selection for Calibration Dialog

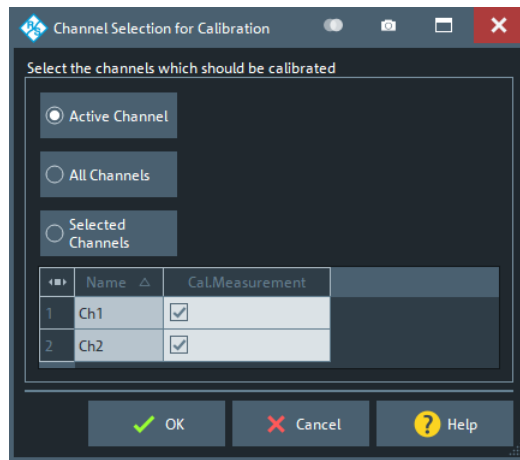

Use

- "Active Channel" if you only want to calibrate the active channel
- "All Channels" if you want to calibrate all channels in the current channel setup
- "Selected Channels" if you want to calibrate only certain channels

10.12.1.3 Calibration Unit Wizard

The "Calibration Unit" wizard guides you through the setup and execution of an automatic calibration.

Access: [Cal] > "Calibration" > "Start... (Cal Unit)"

The wizard proceeds in three steps.

1. [Step 1: Ports](#) allows you to configure the calibration and to select a calibration unit (along with its characterization).
2. [Step 2: Connections](#) allows you to define the port assignments between the R&S ZNL/ZNLE and the calibration unit.
3. [Step 3: Cal Unit](#) guides you through the required measurements on the standards provided by the calibration unit. Finally, you can either apply the resulting error terms to the related channels, or discard them.



Background information

Refer to [Chapter 9.5.5, "Automatic Calibration"](#), on page 260.



- A successful calibration supersedes the previous calibration, discarding all previous system error correction data.
To keep older correction data, you can transfer them to the calibration "Pool" using the [Calibration Manager Dialog](#).
- The system error correction data that are determined in a calibration procedure, are stored in the analyzer. It is possible to retrieve these data using the remote control command `[SENSe<Ch>:]CORRection:CDATA`.

Step 1: Ports

Allows you to define the calibration to be performed and to select the calibration unit to be used (along with its characterization).



Background and related information

Refer to the following sections:

- [Chapter 9.5.1, "Calibration Types"](#), on page 249
- [Chapter 9.5.5.3, "Characterization of Calibration Units"](#), on page 264

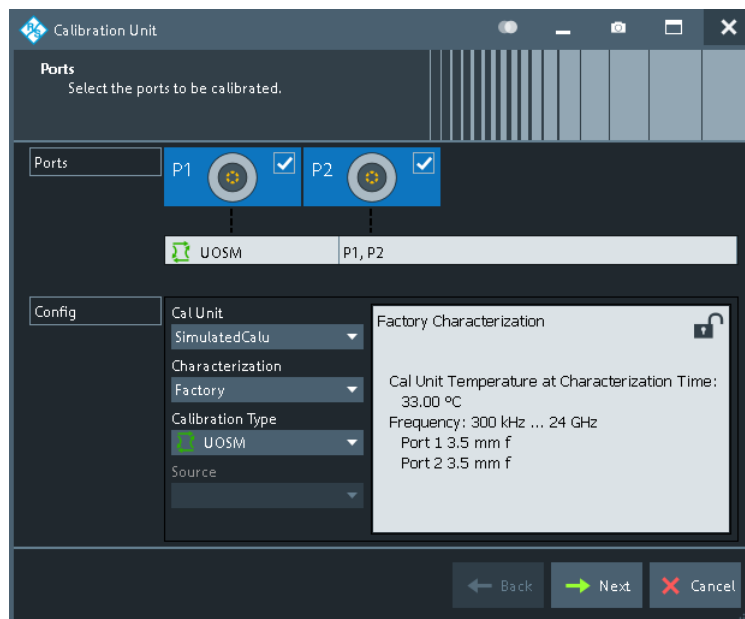

Figure 10-11: Calibration Unit wizard, step 1: Ports

Ports

Selects the test ports to be calibrated.

Note: Calibration and port de-/activation.

The analyzer firmware automatically activates/deactivates ports during/after a (successful) calibration:

- Calibrated ports that were previously disabled, are automatically enabled as single-ended logical ports.

- An uncalibrated port that is not used by a measurement (i.e. the port is not required by any trace of the related channel) is disabled.

Remote command:

The port parameters in many calibration commands define the calibrated ports.

Cal Unit

Displays the connected calibration units. The R&S ZNL/ZNLE auto-detects all calibration units which are connected to one of its USB ports. If several cal units are connected, one of them must be selected for calibration (active cal unit). A warning is displayed if the current sweep range of the network analyzer exceeds the characterized frequency range of the calibration unit.

For background information, see [Chapter 9.5.5, "Automatic Calibration"](#), on page 260.

Remote command:

```
SYSTem:COMMunicate:RDEvice:AKAL:ADDRes:ALL?
```

```
SYSTem:COMMunicate:RDEvice:AKAL:ADDRes
```

Characterization

Displays all characterizations that are stored in the active cal unit. The "Factory" characterization is available for all calibration units; it ensures an accurate calibration for all standard applications. To account for modifications of the cal unit such as the connection of additional adapters, you can generate modified sets of characterization data using the cal unit characterization wizard. See [Chapter 10.12.2.4, "Characterize Cal Unit Dialog"](#), on page 475. By default, the R&S ZNL/ZNLE uses the last generated cal unit characterization.

Tip: If the characterization wizard is password-protected, the "Characterization" button is unavailable. Use this functionality to prevent inadvertent activation of inappropriate characterizations. See ["Authentication"](#) on page 476.

See also [Chapter 9.5.5.3, "Characterization of Calibration Units"](#), on page 264.

Remote command:

```
SYSTem:COMMunicate:RDEvice:AKAL:CKIT:CATalog?
```

```
SYSTem:COMMunicate:RDEvice:AKAL:CKIT:STANdard:CATalog?
```

```
SYSTem:COMMunicate:RDEvice:AKAL:SDATa?
```

Query further cal unit properties:

```
SYSTem:COMMunicate:RDEvice:AKAL:DATE?
```

```
SYSTem:COMMunicate:RDEvice:AKAL:FRANge?
```

```
SYSTem:COMMunicate:RDEvice:AKAL:PORTs?
```

```
SYSTem:COMMunicate:RDEvice:AKAL:WARMup[:STATe]?
```

Calibration Type / Source

Selects the calibration type for the selected physical ports. For an overview, refer to [Table 9-7](#).

The reflection calibration types can be used for any combination of physical ports: reflection calibrations are performed for each selected port.

A transmission calibration type requires at least two physical ports. For the **unidirectional** transmission calibration types ("Trans Norm", "One Path Two Ports"), the direction ("**Source**" port) must be specified in addition.

Transmission normalization and "One Path Two Ports" calibration types require two-port (Through) characterization data for the cal unit. For current calibration units, however, these two-port characterizations are typically not part of the factory characterization. If a tooltip indicates missing two-port characterization data, simply perform a new characterization of your cal unit. In the first dialog of the "Characterization" wizard, select "Take All OSM and Through" to make sure that the necessary two-port data is acquired. See also "[Characterization Wizard](#)" on page 477.

Remote command:

```
[SENSe<Ch>:]CORRection:COLLect:AUTO:TYPE
```

```
[SENSe<Ch>:]CORRection:COLLect:AUTO:PORTs:TYPE
```

Next

Proceeds to [Step 2: Connections](#). "Next" is unavailable (and a warning is displayed) if the following happens:

- The selected characterization data do not cover all the ports to be calibrated.
- The selected characterization data do not contain all standards needed for the selected calibration type.

Step 2: Connections

Defines the port assignments between the R&S ZNL/ZNLE and the calibration unit.

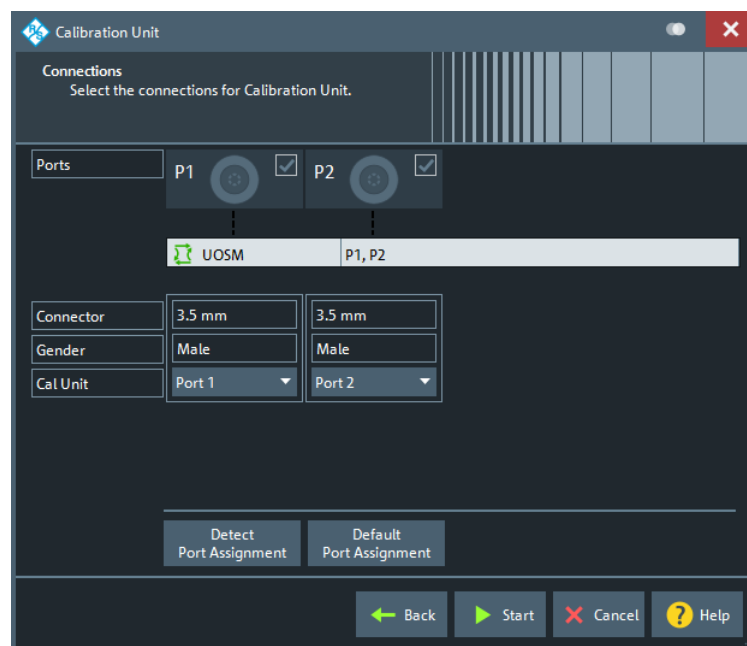

Figure 10-12: Calibration Unit wizard, step 2: Connections

Port Assignment (manual)

The "Connections" step allows you to configure the assignment between VNA ports and calibration unit ports manually.

The test port connectors are automatically set according to the connector type of the selected calibration unit port.

Detect Port Assignment

Starts a procedure by which the R&S ZNL/ZNLE (with a little help from the attached calibration unit) auto-detects the connected ports. The automatic assignment replaces the configured one.

If auto-detection fails because of a high attenuation in the signal path, you can either enter the port assignment manually or connect matching port numbers and select "Default Port Assignment".

Remote command:

```
[SENSe:]CORRection:COLLect:AUTO:PORTs:CONNection?
```

Default Port Assignment

Restores the default port assignment.

Start

Proceeds to [Step 3: Cal Unit](#).

If the configured port assignments are invalid, this action is disabled.

Step 3: Cal Unit

During the calibration phase, the R&S ZNL/ZNLE displays a "Cal Unit" screen that guides the user through the actual correction data acquisition.

In each calibration step

- the calibration unit must be connected according to the depicted port assignment; auto-detection is possible
- the related test ports are calibrated with the "Calibration Type" selected in [Step 1: Ports](#)
- a subsweep is performed for each required test port or port pair and every required standard

After all these calibration steps have been completed, the resulting system error correction can be calculated and applied.

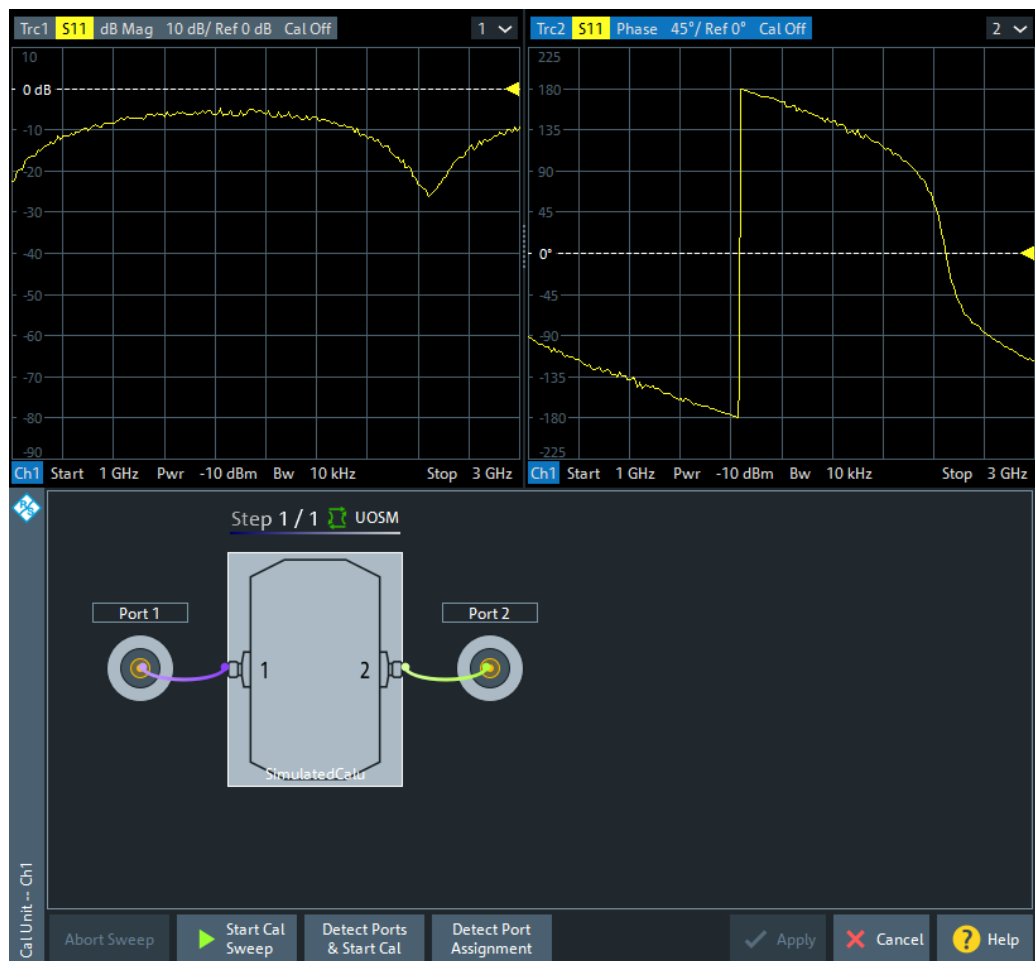

In the upper part of the "Cal Unit" screen, the R&S ZNL/ZNLE shows the calibration sweep diagrams for the currently measured S-parameter. The lower part visualizes the active port assignment and the measurement progress.

Calibration Sweep Diagrams

During the calibration sweep, each diagram contains a single S-parameter trace and a typical result trace for the measured calibration standard.

The purpose of the typical result traces "Trc1" and "Trc2" is to avoid connection errors and to track hardware problems: if the correct standard type is measured, and everything is properly connected, then the measured traces are expected to be similar to the typical trace.

The S-Parameter traces are labeled $P[j_i]_{\text{standard type}} S_{ij}$, where j indicates the input (test) port and i indicates the output port, e.g. $P[1_2]_{\text{Unknown_Through}} S_{21}$.

Detect Ports & Start Cal

Performs the "Detect Port Assignment" and "Start Cal Sweep" functions, one after the other.

Detect Port Assignment

Starts a procedure by which the R&S ZNL/ZNLE (with a little help from the attached calibration unit) auto-detects the connected ports. The automatic assignment replaces the configured one.

In case auto-detection fails

- an error report is shown as a warning dialog
- the undetected port connections are marked with warning signs
- the calibration can be invalid

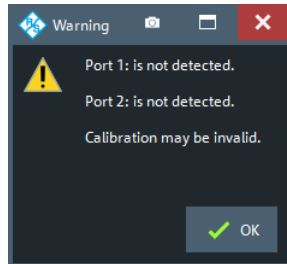

Remote command:

```
[SENSe:]CORRection:COLLect:AUTO:PORTs:CONNection?
```

Apply/Cancel

Apply the calculated system error correction to the active channel (or to all channels in the active channel setup, if all channels were calibrated).

The Apply button is enabled when calibration sweeps have been successfully performed for all required port assignments.

Remote command:

```
[SENSe<Ch>:]CORRection:COLLect:AUTO
[SENSe<Ch>:]CORRection:COLLect:AUTO:PORTs
[SENSe<Ch>:]CORRection:COLLect:AUTO:PORTs:TYPE
[SENSe<Ch>:]CORRection:COLLect:AUTO:TYPE
```

Extended cal unit settings:

```
MMEMoRY:AKAL:FACToRY:CONVeRSion
MMEMoRY:AKAL:USER:CONVeRSion
SYSTem:COMMUnicate:AKAL:CONNection
SYSTem:COMMUnicate:AKAL:MMEMoRY[:STATe]
```

10.12.1.4 Calibration Setting Wizard

The "Calibration Setting" wizard guides you through the setup and execution of a manual system error correction.

Access: [Cal] > "Calibration" > Calibration – "Start... (Manual)"

The wizard proceeds through the following steps:

1. **"Ports and Type":** Select the ports you want to calibrate and the calibration type you want to use.

2. **"Connectors and Cal Kits"**: For all ports you want to calibrate, select the connector type, gender and cal kit. If necessary, import a calibration kit.
3. **"Calibration"**: Acquire measurement data for the required ports or port pairs and the required standards. Finally, decide whether to apply the resulting system error correction or to discard it.



Background and related information

- Refer to [Chapter 9.5, "Calibration"](#), on page 248 for background information
- If the active channel is already equipped with a system error correction, the "Calibration Setting" wizard loads the underlying setup. If the calibration setup is not changed and sweep data are available from previous calibrations, the existing system error correction can be optimized without repeating the measurement of all standards.
- When you apply the new system error correction, the current calibration is replaced and discarded.
To persist the current calibration, you can transfer it to the calibration "Pool" using the [Calibration Manager Dialog](#).
- The active system error correction data can be read (and modified) using the remote control command `[SENSe<Ch>:]CORRection:CDATa`.

Step 1: Ports and Type

Allows you to select the test ports to be calibrated and the calibration type to be used.



Background information

Refer to [Chapter 9.5.1, "Calibration Types"](#), on page 249.

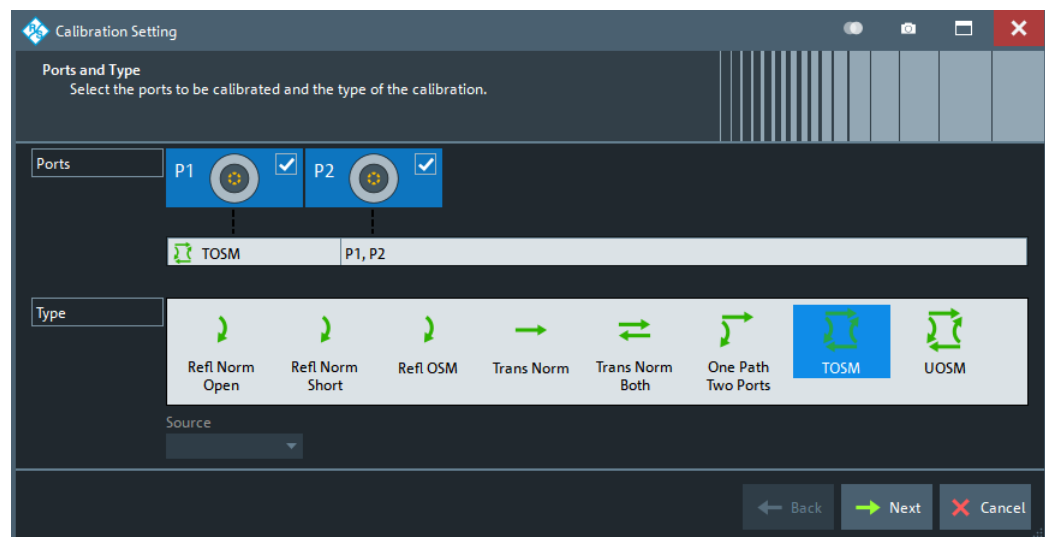



Only a R&S ZNL with VNA board 1323.2967 and firmware version 1.35 or higher supports manual UOSM calibration. For all other instruments "UOSM" is hidden.

To find out which VNA board is installed on your instrument, look up the "FRONTEND VNA" entry in the [hardware info](#) table.

See [Chapter 7.4, "System Configuration Settings"](#), on page 129.

Ports

Selects the test ports to be calibrated.

Note: Calibration and port de-/activation.

The analyzer firmware automatically activates/deactivates ports during/after a (successful) calibration:

- Calibrated ports that were previously disabled, are automatically enabled as single-ended logical ports.
- An uncalibrated port that is not used by a measurement (i.e. the port is not required by any trace of the related channel) is disabled.

Remote command:

The port parameters in many calibration commands define the calibrated ports.

Type/Source

Selects the calibration type. The green arrow symbols give a preview of the type and the number of calibration sweeps involved:

- Curved arrows (example: "Refl Norm Open") denote one or more reflection measurements at each port.
Reflection calibration types can be used for any set of test ports: reflection calibrations are repeated for each port.
- Straight, horizontal arrows (example: "Trans Norm") denote one or more transmission measurements between each pair of two ports.
Transmission calibration types require at least two physical ports. For unidirectional transmission calibration types ("Trans Norm", "One Path Two Ports"), the ("**Source**" port) must be specified in addition.
- The full n-port calibration types ($n > 1$, e.g. "TOSM") are symbolized by a closed square symbol. The number of arrows increases the complexity but can also improve the accuracy of the calibration.

For an overview, refer to [Table 9-7](#).

Remote command:

```
[SENSe<Ch>:]CORRection:COLLect:METhod:DEFine
```

Calibrate all Channels

Check this box to apply the acquired correction data to all channels in the active channel setup. Leave it unchecked (preset setting) to apply them only to the active channel.

Note that this option is available only if the active channel setup contains multiple channels.

Remote command:

```
[SENSe:]CORRection:COLLect:CHANnels:ALL
```

Next

Proceeds to [Step 2: Connectors and Cal Kits](#).

Step 2: Connectors and Cal Kits

Selects the connector type and gender for all ports and allows you to import a calibration kit.



Background information

Refer to [Chapter 9.5.2, "Calibration Standards and Calibration Kits"](#), on page 253.



Messages in the dialog

An information message (or error message) is displayed if one of the following happens:

- One of the selected calibration kits is described by ideal kit parameters or typical values.
- One of the selected calibration kits does not contain all standards that are required for the previously selected calibration type.
- Different connector types are defined at the ports but the selected calibration type requires uniform connectors.
- A cal kit standard does not cover the entire calibrated frequency range.

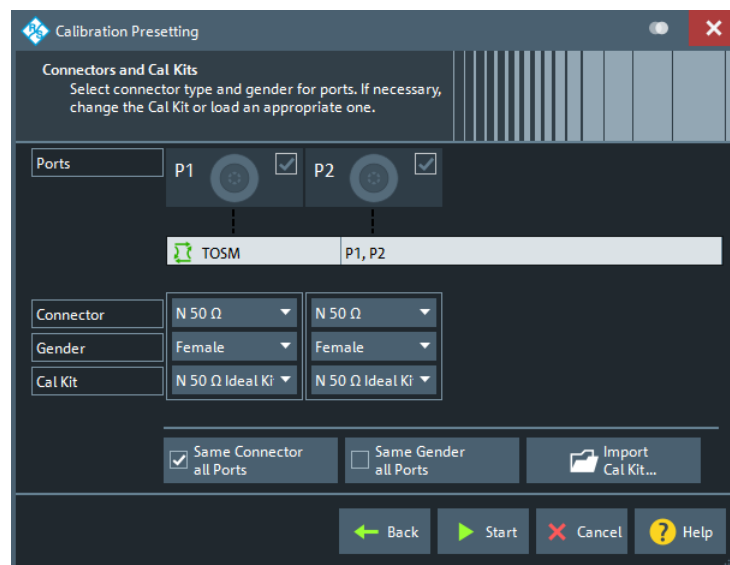

Figure 10-13: Calibration Setting Wizard, Step 2: Connectors and Cal Kits

The upper part of the panel shows the ports and the calibration type selected in [Step 1: Ports and Type](#). The lower part gives access to the connector and cal kit settings.

Connector / Gender

Defines the connector types and genders of the ports to be calibrated. For symmetric (sexless) connector types (e.g. 7 mm / PC7), "Gender" is unavailable.

If "Same Connector All Ports" is active, the connector types at all ports (but not their gender) are always adjusted to the current selection. If "Same Gender All Ports" is active, the genders at all ports are always adjusted to the current selection.

User-defined connectors can be added or removed in the [Cal Connector Types Dialog](#).

Remote command:

```
[SENSe<Ch>:]CORRection:COLLect:CONNection<PhyPt>  
[SENSe<Ch>:]CORRection:COLLect:SCONNection<PhyPt>  
[SENSe<Ch>:]CORRection:CONNection  
[SENSe<Ch>:]CORRection:CONNection:CATalog?  
[SENSe<Ch>:]CORRection:CONNection:DElete
```

Cal Kit

Selects a cal kit for the connector at each selected physical port. The drop-down list contains all available calibration kits for the selected connector type.

The assignment of a calibration kit to a connector type must be the same for all physical ports: If a calibration kit is changed, the R&S ZNL/ZNLE automatically assigns the new kit to all ports with the same connector type.

Use "Import Cal Kit..." to add new kits to the list.

Remote command:

```
[SENSe:]CORRection:CKIT:SElect
```

Same Connector All Ports / Same Gender All Ports

Assigns the same connector type or gender to all selected physical ports. For some multi-port calibration types, the port connector types must be equal, e.g. because they require a Through standard with known characteristics.

Remote command:

```
[SENSe<Ch>:]CORRection:COLLect:CONNection:PORTs  
[SENSe<Ch>:]CORRection:COLLect:CONNection:GENDerS
```

Import Cal Kit...

Opens the "Import Calibration Kit" dialog that allows you to import a cal kit file. For background information, see [Chapter 9.5.2.4, "Cal Kit Files"](#), on page 258.

Remote command:

```
MMEMorY:LOAD:CKIT
```

Back

Go back to [Step 1: Ports and Type](#).

Start

Start [Step 3: Calibration](#).

Step 3: Calibration

Allows you to acquire error correction data for every required port (pair) and calibration standard, where "required" depends on the selected ports and calibration type. On "Apply", the R&S ZNL/ZNLE calculates the system error correction (error terms) from the measurement data of the standards and applies the result to the active channel.

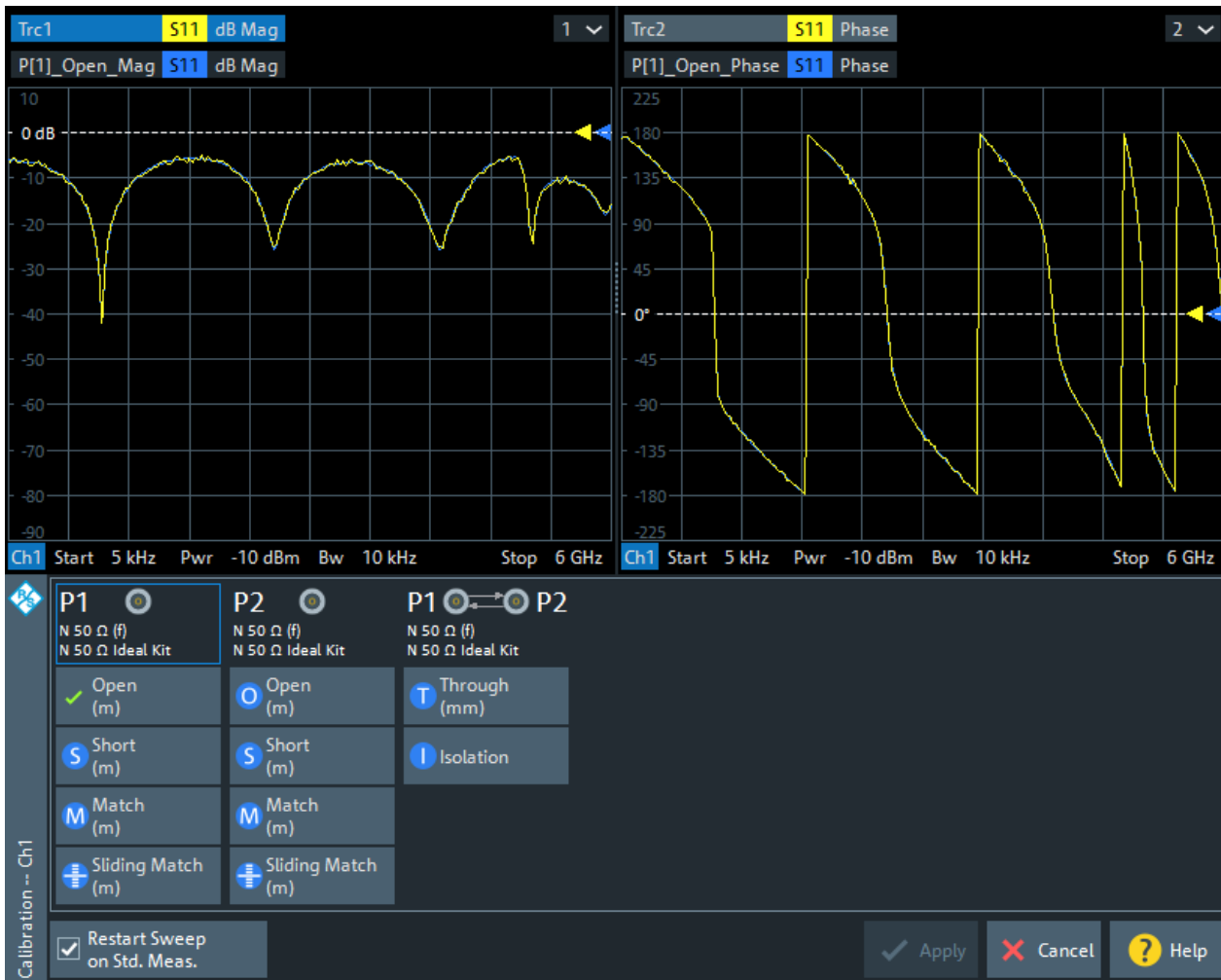

Figure 10-14: Calibration Setting Wizard, Step 3: Calibration

In the upper part of the "Calibration" screen, the R&S ZNL/ZNLE shows the sweep diagrams for the currently measured S-parameter. The lower part displays the calibrated ports and standards and visualizes the measurement progress.

Calibration Sweep Diagrams

During the calibration sweep, each diagram contains a single S-parameter trace and a typical result trace for the measured calibration standard.

The purpose of the typical result traces "Trc1" and "Trc2" is to avoid connection errors and to track hardware problems: if the correct standard type is measured, and everything is properly connected, then the measured traces are expected to be similar to the typical trace.

The S-Parameter traces are labeled $P[j_i]_{\text{standard type}} S_{ij}$, where j indicates the input (test) port and i indicates the output port, e.g. $P[1_2]_{\text{Unknown_Through}} S_{21}$.

Start Cal Sweep

The dock widget below the diagrams shows the calibrated ports and standards and visualizes the measurement progress.

Use the buttons representing the calibration standards to start the corresponding calibration sweeps.

If "Show Cal Kit Label" is enabled on the [Calibration Tab](#) of the VNA Setup dialog, an additional "Calibration Info" dialog is displayed. In this case, the cal sweep is started from this dialog.



"Don't Show this Dialog Again" has the same effect as disabling "Show Cal Kit Label".

A green checkmark indicates that the calibration data of a standard has been acquired successfully. A green checkmark after the port symbol indicates that the minimum number of calibration measurements for the port has been performed.

Tip:

- If the selected calibration kit comprises a Sliding Match, then for every required Match measurement either the Match or at least three positions of the Sliding Match must be measured. See [Chapter 9.5.2.3, "Sliding Match Standards"](#), on page 257.

Remote command:

```
[SENSe<Ch>:]CORRection:COLLect[:ACQuire]:SElected
```

See also: `[SENSe<Ch>:]CORRection:COLLect:LOAD:SElected`

Restart Sweep on Std. Meas.

If this function is active, a new standard measurement initiates a new sweep, starting at the beginning ("Start") of the sweep range: The sweep points for the calibration sweep are in ascending order, like for an ordinary measurement.

If "Restart Sweep on Std. Meas." is inactive, the new standard measurement is started at the current sweep point; the current sweep is continued as a calibration sweep.

Apply

Is enabled when sufficient data have been acquired for the calibrated ports and standards. The button starts the calculation of the system error correction and closes the calibration wizard. The current instrument settings are stored with the correction data.

To avoid incompatibilities, older calibration data is deleted unless it has been transferred into the calibration "Pool" using the "Calibration Manager" (see [Chapter 10.12.3.2, "Calibration Manager Dialog"](#), on page 481).

Note: Checks during the calculation of correction data

Incompatibilities between the selected calibration type, the standards and the channel settings can cause the calibration to be inaccurate. The analyzer auto-detects potential sources of errors and displays appropriate, self-explanatory notice boxes.

Remote command:

```
[SENSe<Ch>:]CORRection:COLLect:SAVE:SELEcted[:DUMMy]
[SENSe<Ch>:]CORRection:COLLect:SAVE:SELEcted:DEFault
[SENSe<Ch>:]CORRection:COLLect:DELEte
[SENSe<Ch>:]CORRection:DATA:PARAmeter<Sfk>?
[SENSe<Ch>:]CORRection:DATE?
[SENSe<Chn>:]CORRection:SState?
[SENSe<Ch>:]CORRection:STIMulus?
```

10.12.2 Manage Calibration Devices

The middle part of the "Calibration" tab provides access to all functions for calibration kit management and cal unit characterization.

10.12.2.1 Related Controls on the Calibration Tab

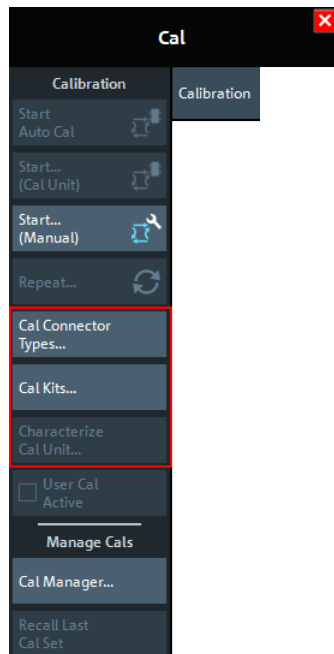

The buttons in the middle of the "Calibration" tab open the following dialogs:

- **"Cal Connector Types..."**: See [Chapter 10.12.2.2, "Cal Connector Types Dialog"](#), on page 468
- **"Cal Kits..."**: See [Chapter 10.12.2.3, "Calibration Kits Dialog"](#), on page 470
- **"Characterize Cal Unit..."**: See [Chapter 10.12.2.4, "Characterize Cal Unit Dialog"](#), on page 475

10.12.2.2 Cal Connector Types Dialog

The "Cal Connector Types" dialog displays and modifies the list of available connector types. Cal connector types must be selected in accordance with the connectors of the measured DUT.

Access: [Cal] > "Cal Connector Types..."

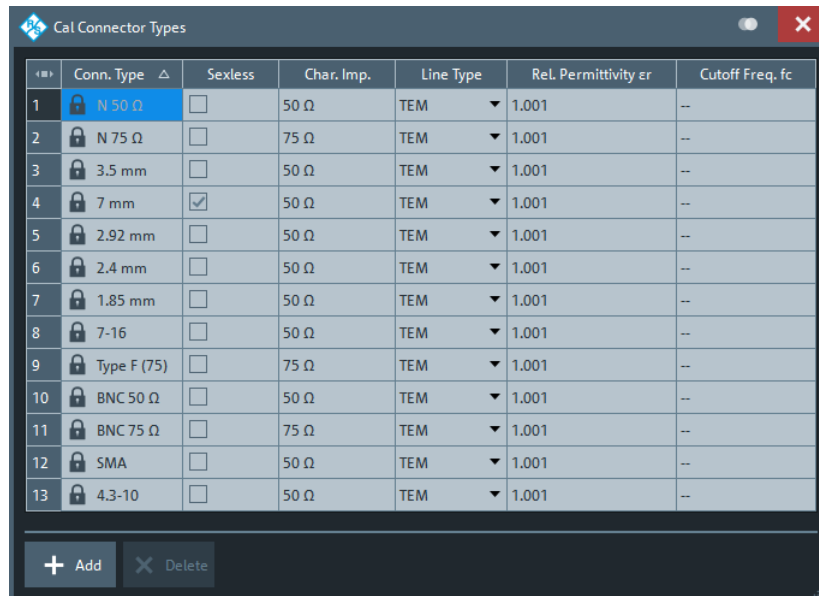

#	Conn. Type	Sexless	Char. Imp.	Line Type	Rel. Permittivity ϵ_r	Cutoff Freq. fc
1	N 50 Ω	<input type="checkbox"/>	50 Ω	TEM	1.001	--
2	N 75 Ω	<input type="checkbox"/>	75 Ω	TEM	1.001	--
3	3.5 mm	<input type="checkbox"/>	50 Ω	TEM	1.001	--
4	7 mm	<input checked="" type="checkbox"/>	50 Ω	TEM	1.001	--
5	2.92 mm	<input type="checkbox"/>	50 Ω	TEM	1.001	--
6	2.4 mm	<input type="checkbox"/>	50 Ω	TEM	1.001	--
7	1.85 mm	<input type="checkbox"/>	50 Ω	TEM	1.001	--
8	7-16	<input type="checkbox"/>	50 Ω	TEM	1.001	--
9	Type F (75)	<input type="checkbox"/>	75 Ω	TEM	1.001	--
10	BNC 50 Ω	<input type="checkbox"/>	50 Ω	TEM	1.001	--
11	BNC 75 Ω	<input type="checkbox"/>	75 Ω	TEM	1.001	--
12	SMA	<input type="checkbox"/>	50 Ω	TEM	1.001	--
13	4.3-10	<input type="checkbox"/>	50 Ω	TEM	1.001	--

The list shows the available connector types with their name ("Conn. Type") and polarity ("Sexless"). The remaining columns in the list are described below.



Storing connector type settings

Calibration kits and connector types are global resources; the parameters are stored independently and available for all channel setups. The connector type settings are always stored together with the associated calibration kit parameters. The [Calibration Kits Dialog](#) provides buttons to export and import cal kit and connector settings.



After assigning a calibration kit to a user-defined connector type, you can still change its name, offset model and reference impedance. If you switch between sexed and sexless, all kits assigned to the connector type are deleted.

Char. Imp.

The characteristic impedance or reference impedance ("Char. Imp.") Z_0 for the connectors is a critical value that has an impact on various parameter conversions. Z_0 enters into:

- The calculation of the S-parameters for the calibration standards associated with the connector type, if they are derived from a circuit model (see ["View / Modify Cal Kit Standards Dialog"](#) on page 474).
- The calculation of the (default) reference impedances for balanced ports (see ["Reference Impedance Tab"](#) on page 381).

- The calculation of impedance and admittance parameters (see [Chapter 9.3.3, "Impedance Parameters"](#), on page 221 and [Chapter 9.3.4, "Admittance Parameters"](#), on page 224).

Remote command:

```
[SENSe<Ch>:]CORRection:CONNection
```

Line Type / Rel. Permittivity ϵ_r / Cutoff Freq. f_c

"Line Type" describes the wave propagation mode (offset model) in the transmission lines of the standards associated with the connector type.

- If the calibration kit standards contain lines with transverse electric propagation mode (TEM, e.g. coax cables), then the "Rel. Permittivity ϵ_r " of the dielectric can be defined. The default permittivity is the value for air. TEM-type lines have no cutoff frequency.
- If the calibration kit standards contain waveguides, then the lowest frequency where a wave propagation is possible ("Cutoff Freq. f_c ") can be defined. The default cutoff frequency is 0 Hz (propagation at all frequencies). No relative permittivity is needed for waveguides.

Note: The impedance for waveguides is frequency-dependent. If a waveguide line type is selected, various dialogs indicate "varies" instead of a definite impedance value.

Impact of line type parameters

The line type parameters are used for the calculation of the S-parameters for the calibration standards associated with the connector type, if they are derived from a circuit model (see ["View / Modify Cal Kit Standards Dialog"](#) on page 474).

- For TEM-type lines, the relative permittivity ϵ_r is needed for the conversion of a ZVR-type "Loss" (in units of dB/sqrt(GHz)) into a Keysight-type "Offset Loss" (in units of G Ω /s) and vice versa (see ["View / Modify Cal Kit Standards Dialog"](#) on page 474). The "Electrical Length" and "Delay" values in the [View / Modify Cal Kit Standards Dialog](#) are directly entered and therefore independent of ϵ_r .
- For waveguides, the low frequency cutoff frequency f_c is important because no wave propagation is possible at frequencies below f_c . If a standard is measured to acquire calibration data, the analyzer checks the low frequency cutoff. If the start frequency of the sweep range is below f_c , an error message is generated.

The offset model parameters are not used except in the context of calibration. The offset parameter definitions are based on independent ϵ_r values; see [Chapter 10.14.2, "Offset Tab"](#), on page 499.

Remote command:

```
[SENSe<Ch>:]CORRection:CONNection
```

Add / Delete

Adds or deletes a user-defined connector type. The parameters of a user-defined connector type can be modified in the table.

Note: Deleted/Missing Connector Types.

- Deleting a connector type also deletes all calibration or adapter kits assigned to it.
- Deleting a connector type that is used by a loaded channel setup resets the affected ports to the instrument's connector type and gender.
- A setup can only be loaded if all its connector types (identified by their names) are configured at the target instrument.

Remote command:

```
[SENSe<Ch>:]CORRection:CONNection  
[SENSe<Ch>:]CORRection:CONNection:CATalog?  
[SENSe<Ch>:]CORRection:CONNection:DELeTe
```

10.12.2.3 Calibration Kits Dialog

The "Calibration Kits" dialog shows the available calibration kits for the different connector types. It is also used for cal kit and cal kit file management.

Access: [Cal] > "Cal Kits..."



Related information

Refer to the following sections:

- See also [Chapter 9.5.2, "Calibration Standards and Calibration Kits"](#), on page 253
- [Chapter 9.5.2.4, "Cal Kit Files"](#), on page 258
- [Chapter 9.5.2.2, "Cal Kit Parameter Types"](#), on page 256
- [Chapter 10.12.2.2, "Cal Connector Types Dialog"](#), on page 468

The contents of the "Available Cal Kits" table vary, depending on the selected "Connector Type". The table can also contain kits with ideal or typical parameter values; see [Cal Kit Parameter Types](#). The "Keysight Model" is an optional scheme to characterize the offset parameters of the standards; see ["Offset Parameters"](#) on page 474.



Cal kit labels

Assigning a "Label" to user-defined calibration kits is optional. However, the label is displayed in many dialogs and can provide useful information about the kit, e.g. its serial number. It is even possible to assign several calibration kits with the same name, distinguished by their label, to a common connector type. See also ["\[SENSe:\]CORRection:CKIT... with Labels"](#) on page 831.

Controls in the Calibration Kits Dialog

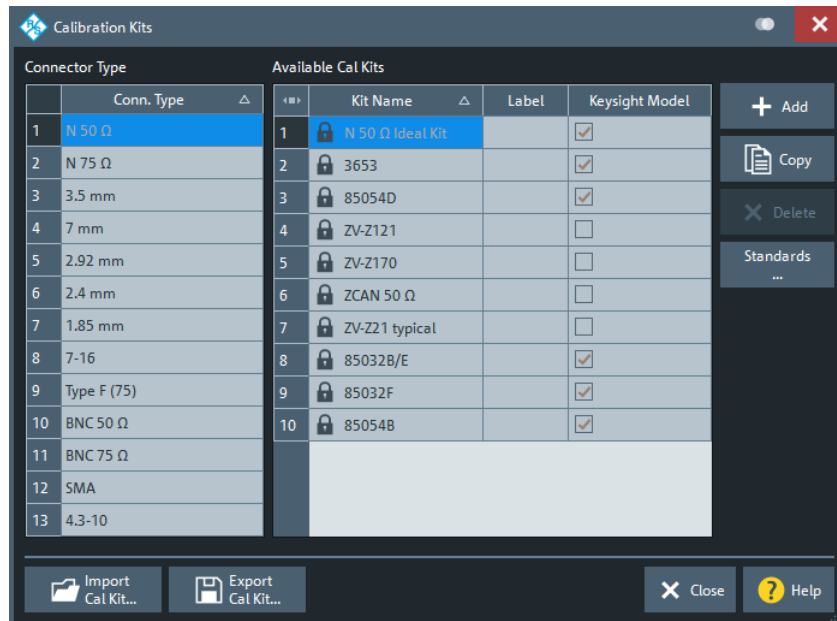

Connector Type

The "Connector Type" table displays the available cal kit connector types. Select a row in this table to get the list of [Available Cal Kits](#).

Remote command:

```
[SENSe<Ch>:]CORRection:CONNection:CATalog?
```

Available Cal Kits

Displays the cal kits for the selected [Connector Type](#)

Remote command:

```
[SENSe:]CORRection:CKIT:CATalog?
```

Add / Copy / Delete / Standards...

The buttons in the right part of the dialog are used to manage calibration kits:

- "Add" creates a cal kit file for the selected connector type.
- "Copy" creates a cal kit file based on the contents of an existing cal kit file.
- "Delete" deletes an imported or user-defined cal kit file.
- "Standards..." opens the "Kit Standards" dialog, which shows the contents of the cal kit file. For user-defined or imported kits, you can modify the contents. See ["Kit Standards Dialog"](#) on page 472.

Remote command:

The following commands create and modify calibration kits:

```
[SENSe:]CORRection:CKIT:<ConnType>:SElect
```

```
[SENSe:]CORRection:CKIT:<ConnType>:LSElect
```

```
[SENSe:]CORRection:CKIT:DMODE
```

```
[SENSe:]CORRection:CKIT:DElete
```

Query connector types and calibration kits:

[SENSe<Ch>:]CORRection:CONNection:CATalog?

[SENSe:]CORRection:CKIT:CATalog?

Import Cal Kit... / Export Cal Kit...

The buttons below the "Connector Type" list are used to store cal kit data to a file and to reload previously stored cal kit files. By default, calibration kit files are stored in the C:\Users\Public\Documents\Rohde-Schwarz\ZNL\Calibration directory; see [Chapter 9.5.2.4, "Cal Kit Files"](#), on page 258.

Remote command:

MMEMory:LOAD:CKIT

MMEMory:STORE:CKIT

Kit Standards Dialog

The "Kit Standards" dialog shows the calibration standards in a selected calibration kit. It is also used to modify the contents of a user-defined kit.



Related information

Refer to the following sections:

- [Chapter 9.5.2.4, "Cal Kit Files"](#), on page 258
- [Chapter 10.12.2.3, "Calibration Kits Dialog"](#), on page 470
- [Chapter 9.5.2.1, "Calibration Standard Types"](#), on page 254

Access: [Calibration Kits Dialog](#) > "Standards..."

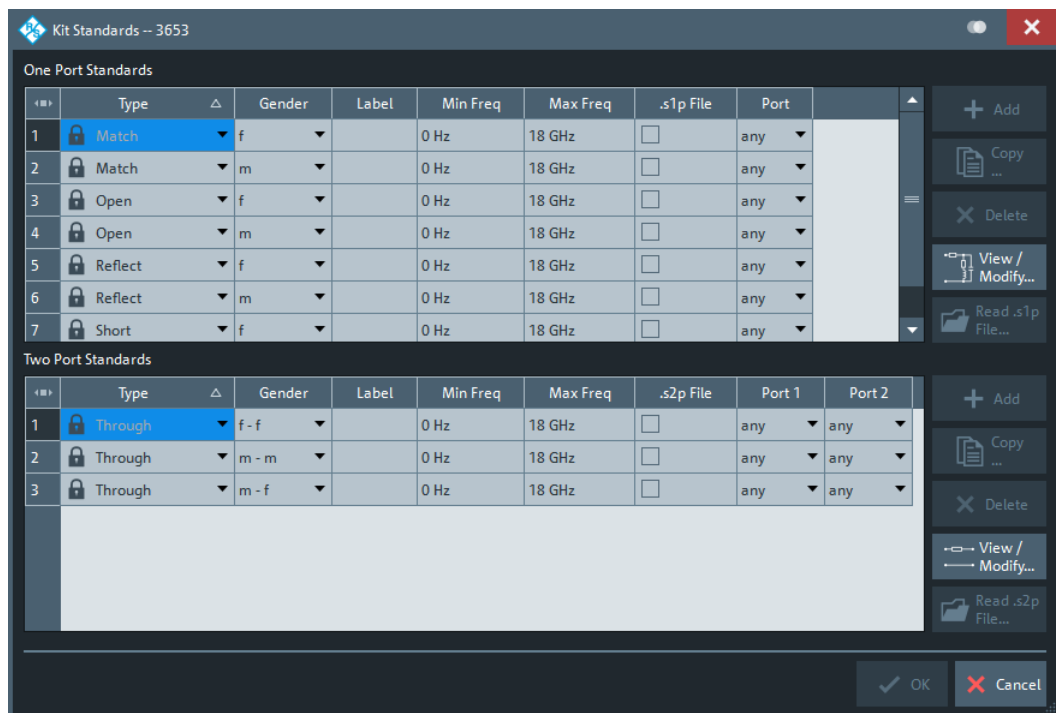

One port and two port standards are listed in two separate tables. Most of the buttons on the right side are available only if the "Kit Standards" dialog was opened for a user-defined calibration kit.

One Port Standards / Two Port Standards

The standard tables contain the following information:

- "Type" and "Gender" describe the calibration standard type; for an overview see [Chapter 9.5.2.1, "Calibration Standard Types"](#), on page 254.
- "Label" is a user defined name of the standard. The label can help you identify a standard or distinguish different standards with similar parameters.
- "Min Freq" and "Max Freq" define the rated frequency range of the standard. During calibration, the analyzer checks whether the sweep range is within the validity range of all measured standards and possibly generates a warning.
- ".s1p File" and ".s2p File" define whether the characteristics of the standard are described by a Touchstone file rather than by a circuit model from which the R&S ZNL/ZNLE can calculate the S-parameters. See ["Read .s1p File... / Read .s2p File..."](#) on page 474 and ["View / Modify Cal Kit Standards Dialog"](#) on page 474.
- "Port" defines whether the standard can be connected to any analyzer port or to just one port (for one-port standards) or a pair of ports (for two-port standards). Standards with unrestricted port assignment ("any") are stored with their gender. When a connector type and calibration kit is selected for the calibration, the analyzer checks whether the kit contains the required standard types and whether the standards have the right gender.

Standards with restricted port assignment are always assumed to have the gender that is appropriate for the calibrated port. The **port assignment** is stored in the calibration kit file, instead of the gender. During the calibration, the analyzer checks whether the cal kit contains the necessary standard types for the required ports.

Remote command:

```
[SENSe:]CORRection:CKIT:<StandardType>
[SENSe:]CORRection:CKIT:<ConnType>:SElect
```

Add / Copy... / Delete / View / Modify...

The buttons in the right part of the dialog are used to manage standards:

- "Add" adds a new standard to the calibration kit. The properties of the standard can be edited in the table.
- "Copy..." creates a standard based on the properties of an existing standard.
- "Delete" deletes the selected standard.
- "View / Modify..." opens the "View / Modify Cal Kit Standards" dialog. This dialog shows the circuit model for the selected standard. For user-defined standard, you can modify the circuit model parameters. See ["View / Modify Cal Kit Standards Dialog"](#) on page 474.

Remote command:

```
[SENSe:]CORRection:CKIT:<StandardType>
[SENSe:]CORRection:CKIT:<StandardType>:WLAbel
```

Read .s1p File... / Read .s2p File...

Opens a file selection dialog where you can select a Touchstone file containing the reflection or transmission S-parameters for the standard. The R&S ZNL/ZNLE uses the imported S-parameters rather than the circuit model to characterize the standard, if ".s1p File"/".s2p File" is checked in the standard table. The appropriate file type (* .s1p for one-port standards and * .s2p for two-port standards) is selected automatically.

Remote command:

MMEMory:LOAD:CKIT:SDATa

View / Modify Cal Kit Standards Dialog

The "View / Modify Cal Kit Standards" dialog shows the circuit model for a selected calibration standard. It is also used to define or edit the circuit model (offset and load) parameters for a user-defined standard.

**Related information**

Refer to the following sections:

- [Chapter 9.5.2.4, "Cal Kit Files"](#), on page 258
- ["Kit Standards Dialog"](#) on page 472
- [Chapter 9.5.2.1, "Calibration Standard Types"](#), on page 254

Access: [Kit Standards Dialog](#) > "View / Modify..."

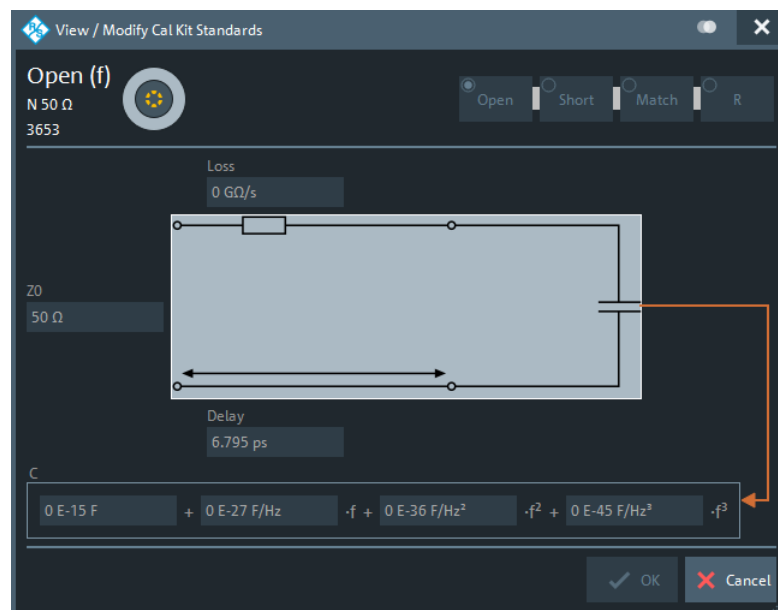

The diagram in the "View / Modify Cal Kit Standards" dialog depends on the standard type for which the dialog was opened. Moreover, it is possible to modify the circuit model using the buttons in the upper right of the dialog.

Offset Parameters

The entries in the upper part of the "View / Modify Cal Kit Standards" dialog specify the offset parameters for the transmission lines of the selected calibration standard.

The offset parameters depend on whether the circuit model is defined as "Keysight Model" (see [Chapter 10.12.2.2, "Cal Connector Types Dialog"](#), on page 468):

- In a "Keysight Model", a calibration standard is characterized by its "Delay" (in s), its characteristic impedance "Z0" (in Ω) and its "Offset Loss" (in G Ω /s).
- Otherwise the standard is characterized by the R&S ZVR-compatible parameters "Electrical Length" (in m), "Char. Imp." (in Ω) and "Loss" (in dB/sqrt(GHz)). The loss is zero and not editable as long as the electrical length is zero.

Both parameter sets are closely related. The "Electrical Length" is proportional to the "Delay"; "Z0" corresponds to the "Char. Imp.". Moreover the analyzer converts a Keysight-type "Offset Loss" into a R&S ZVR-type "Loss" and vice versa using the "Rel. Permittivity ϵ_r " for the selected connector type.

See also description of the offset parameters in [Chapter 9.5.2.1, "Calibration Standard Types"](#), on page 254.

Remote command:

```
[SENSe:]CORRection:CKIT:<StandardType>
```

Load Parameters

The entries in the lower part of the "View / Modify Cal Kit Standards" dialog specify the load parameters for a particular calibration standard describing its terminal impedance.

The circuit model for the load consists of capacitance C which is connected in parallel to an inductance L and a resistance R, both connected in series.

- R is the constant resistive contribution. It is possible to select:
 - "Open" for $\infty \Omega$ (so that the inductance coefficients are irrelevant)
 - "Short" for 0Ω
 - "Match" for the reference impedance of the current connector type
 - any resistance "R"
- The fringing capacitance C and the residual inductance L are both assumed to be frequency-dependent and approximated by the first four terms of the Taylor series around $f = 0$ Hz.

See also description of the load parameters for the different standard types in [Chapter 9.5.2.1, "Calibration Standard Types"](#), on page 254.

Remote command:

```
[SENSe:]CORRection:CKIT:<StandardType>
```

10.12.2.4 Characterize Cal Unit Dialog

The "Characterize Cal Unit" dialog displays the properties of the connected cal units, provides control elements for characterization file management, and starts the characterization wizard.

Access: [Cal] > "Characterize Cal Unit..."



Background information

Refer to [Chapter 9.5.5.3, "Characterization of Calibration Units"](#), on page 264.



A cal unit characterization can be performed in a frequency sweep. The "Characterize Cal Unit" dialog is unavailable while a CW Mode or time sweep is active. The analyzer always uses a fixed source power of -10 dBm to acquire the characterization data.

Controls in the Characterize Cal Unit Dialog

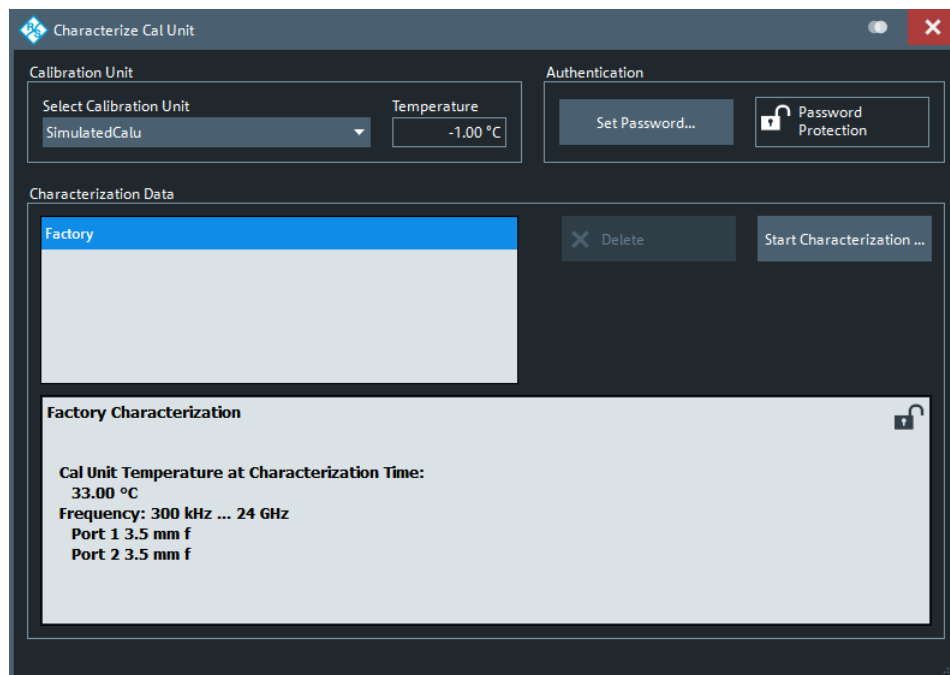

Calibration Unit

Displays the connected calibration units. The R&S ZNL/ZNLE auto-detects all calibration units which are connected to one of its USB ports. If several cal units are connected, one of them must be selected for characterization (active cal unit).

Remote command:

```
SYSTem:COMMunicate:RDEvice:AKAL:ADDRESS:ALL?
```

```
SYSTem:COMMunicate:RDEvice:AKAL:ADDRESS
```

Authentication

Allows you to set a password to protect the characterization dialog and the [Characterization Wizard](#) from unauthorized access and operation. "Set Password..." opens a dialog to enter the password and activate password protection at the next time the "Set Password" dialog is opened. Enter an empty string (no password) to deactivate password protection.

Tip: A password also blocks a switchover of the active characterization during calibration; see "[Characterization](#)" on page 456.

Remote command:

```
[SENSe:]CORRection:COLLect:AUTO:CKIT:PASSWORD
```

Characterization Data

Displays all characterizations which are stored on the active cal unit. The "Factory" characterization is available for all calibration units; it ensures an accurate calibration for all standard applications. Characterizations stored on an SD card (inserted at the cal unit) are prefixed with "SD:".

Tip: Characterizations stored on an SD card (inserted at the cal unit) are prefixed with "SD:".

The properties of the selected characterization are shown below the list. "Delete" deletes the selected characterization file; "Start Characterization..." opens the [Characterization Wizard](#) to create a characterization.

Remote command:

```
SYSTem:COMMunicate:RDEvice:AKAL:CKIT:CATalog?
```

```
SYSTem:COMMunicate:RDEvice:AKAL:CKIT:STANdard:CATalog?
```

```
SYSTem:COMMunicate:RDEvice:AKAL:SDATa?
```

Characterization Wizard

The "Characterization" wizard guides you through the automatic characterization of a calibration unit.

Access: [Characterization Wizard](#) > "Start Characterization..."

The guided characterization consists of the following steps:

1. **"Characterization"**: Select the characterized ports and cal unit standards to initiate the characterization sweeps.
2. **"Save Characterization Data"**: Save the characterization data to the calibration unit.

Step 1: Characterization

Selects the calibration type and the characterized cal unit ports and initiates the necessary characterization sweeps.



Characterization procedure

To acquire accurate characterization data, the test setup must be properly calibrated before you start the characterization wizard. Use the calibration type that you wish to perform with your new cal unit characterization; see [Chapter 9.5.5.3, "Characterization of Calibration Units"](#), on page 264.

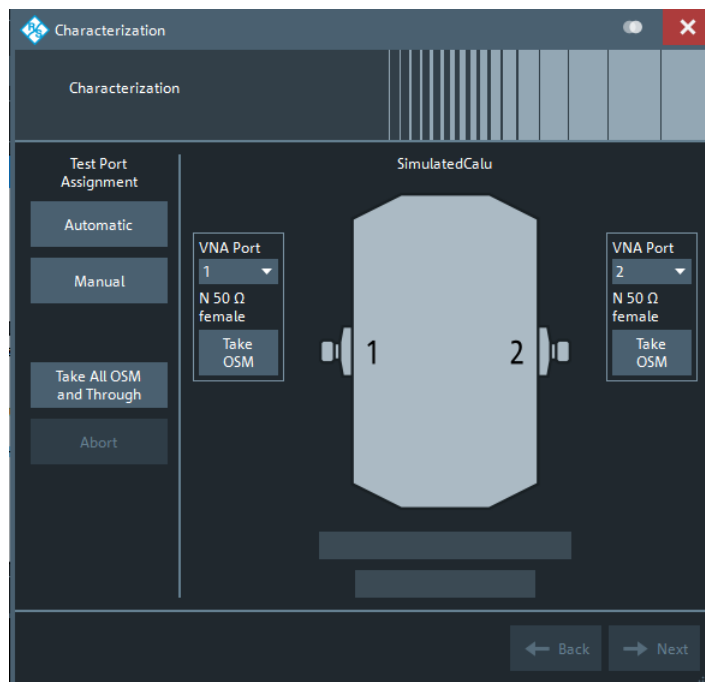

Test Port Assignment

Defines the assignment between test ports and cal unit ports. In the default "Manual" assignment, VNA ports and cal unit port numbers match. If you decide to use a different assignment, you can auto-detect the actual assignment ("Automatic") or select the analyzer port numbers manually. Auto-detection can fail, e.g., because of a high attenuation in the signal path.

Remote command:

```
[SENSe<Ch>:]CORRection:COLLect:AUTO
[SENSe<Ch>:]CORRection:COLLect:AUTO:PORTs
[SENSe:]CORRection:COLLect:AUTO:PORTs:CONNection?
[SENSe:]CORRection:COLLect:AUTO:CKIT:PORTs
```

Take OSM / Take All OSM and Through

"Take OSM" starts a calibration sweep for the related port. "Take All OSM and Through" initiates a series of calibration sweeps; the R&S ZNL/ZNLE acquires a full set of one-port and two-port data. The latter is required for the transmission normalizations and for a "One Path Two Ports" calibration; see ["Dependency between calibration types and characterization data"](#) on page 264.

Remote command:

```
[SENSe<Ch>:]CORRection:COLLect:AUTO
[SENSe<Ch>:]CORRection:COLLect:AUTO:PORTs
[SENSe:]CORRection:COLLect:AUTO:PORTs:CONNection?
```

Next

Proceeds to [Step 2: Save Characterization Data](#) . Next is available when the R&S ZNL/ZNLE has acquired characterization data for a single port.

Step 2: Save Characterization Data

Saves the characterization data to the calibration unit.

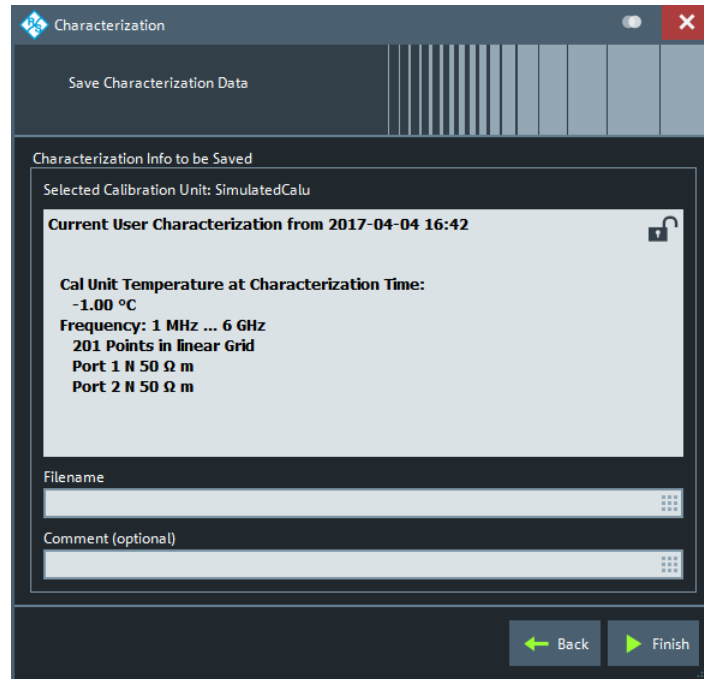

Figure 10-15: Save Characterization Data

Save File to SD Card

For all calibration units, characterization data can be saved to the calibration unit's internal flash memory. For some calibration units (e.g. the new models R&S ZN-Z5x and R&S ZN-Z15x), they can also be saved to an SD card inserted at the calibration unit. Activate this checkbox to save the characterization data to the SD card.

Tip: If the characterized calibration unit does not have an SD card slot, the checkbox is hidden. If the calibration unit has an SD card slot but the SD card is not accessible, the checkbox is grayed out.

File name / Comment (Optional)

Selects a filename to reference the characterization data set in the "Characterize Cal Unit" and "Calibration Unit" dialogs and a comment, to be written into the characterization file. A filename is required before you can "Finish" the characterization wizard and store the data.

Remote command:

`[SENSe:]CORRection:COLLect:AUTO:CKIT`

10.12.3 Manage User Calibrations

The lower part of the "Calibration" tab provides access to functions for (de-)activating and managing calibrations.

10.12.3.1 Related Controls on the Calibration Tab

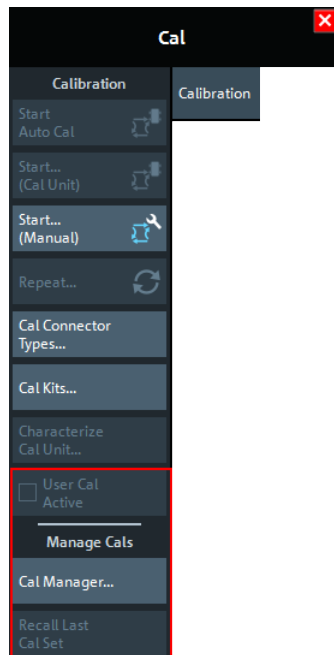

The buttons in the lower part of the "Calibration" tab open the following dialogs:

- **"Manage Cals" – "Cal Manager..."**: See [Calibration Manager Dialog](#)

User Cal Active

Activates or deactivates the system error correction in the active channel. "User Cal Active" is available only if a valid system error correction is available for the active channel; see "Channel State" in [Chapter 10.12.3.2, "Calibration Manager Dialog"](#), on page 481.

Note: A label "Cal Off" appears behind the trace list if the system error correction is switched off; see also [Chapter 9.5.4, "Calibration Labels"](#), on page 260. The calibration status of each channel and trace appears in the setup information ("Setup" > "Info..." > "Setup").

Remote command:

```
[SENSe<Ch>:]CORRection[:STATe]
```

Manage Cals – Recall Last Cal Set

Loads and activates the channel setup for which the last calibration was performed. If the last calibrated setup is already active, nothing is changed. The calibrated setups are automatically stored in the

C:\Users\Public\Documents\Rohde-Schwarz\ZNL\Calibration\RecallSets directory. A message box pops up if the directory is empty, e.g. because no calibration was performed yet.

Remote command:

n/a

10.12.3.2 Calibration Manager Dialog

The "Calibration Manager" dialog stores user correction data to the cal pool and assigns stored correction data to channels.

See [Chapter 9.5.3, "Calibration Pool"](#), on page 259 for background information.

Access: [Cal] > "Cal Manager..."

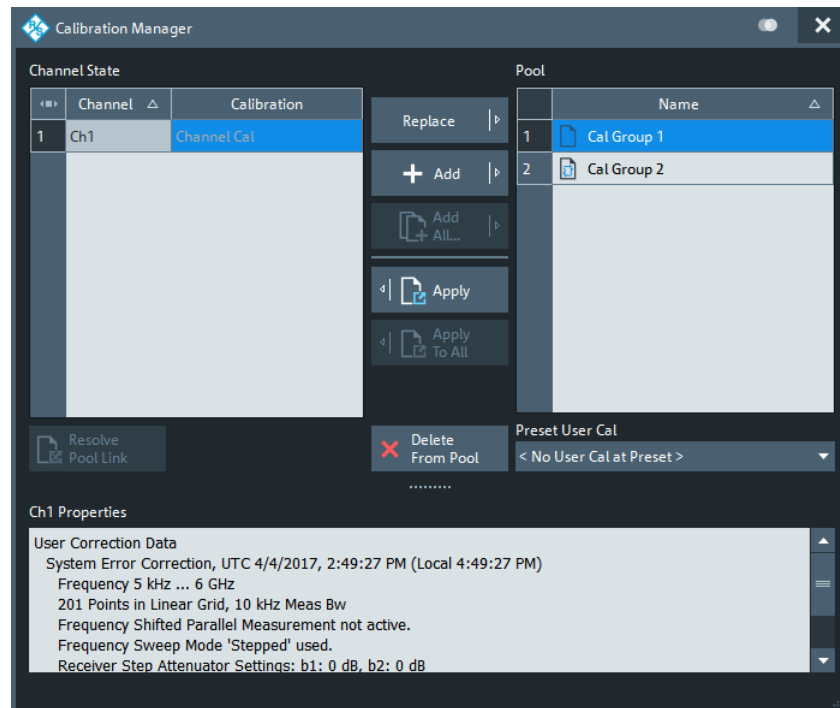

Channel State

The "Channel State" table shows all channels in the active channel setup together with their current calibration. Channels can use either the active channel calibration (if available), a previously stored user correction data or the factory system error correction (indicated as '--').

Remote command:

n/a

Add / Add All... / Replace / Apply / Apply to All

The buttons between the tables are used to modify the calibration pool and apply calibration data sets (cal groups) to channels:

- "Add" copies the correction data of the selected channel to the cal pool, generating a new pool member (cal group).
- "Add All..." copies the correction data of all channels to the cal pool, generating new pool members (cal groups).
- "Replace" overwrites a cal group with new correction data.
- "Apply" assigns the selected cal group to the selected channel.
- "Apply to All" assigns the selected cal group to all channels in the "Channel State" table.

For channels that are linked to a "Cal Group" (using "Apply" or "Apply to All"), a new calibration overwrites the cal group data and hence affects all channels that are also linked to this cal group. An "Overwrite Warning" is displayed in this case. To continue with the calibration, confirm by using button "Overwrite Current File?" or "[Resolve Pool Link / Remove Pool Link](#)" on page 482.

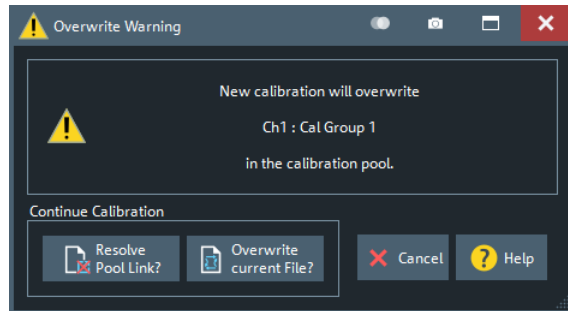

Remote command:

```
MMEMory:STORe:CORRection
MMEMory:LOAD:CORRection
MMEMory:LOAD:CORRection:MERGe
```

Pool / Delete from Pool

The "Pool" table shows all correction data sets `<CalGroup_name>.cal` in the directory `C:\Users\Public\Documents\Rohde-Schwarz\ZNL\Calibration\Data`. The name of a pool data set can be modified directly in the corresponding table cell.

"Delete from Pool" deletes a cal group file from the pool. **Note** however, that calibrations being used in any of the opened channel setups cannot be deleted.

Remote command:

```
MMEMory:DELeTe:CORRection
```

Preset User Cal

Selects a cal group from the pool that is activated during a user-defined preset.

Remote command:

```
SYSTem:PRESet:USER:CAL
```

Resolve Pool Link / Remove Pool Link

Deletes a link between the selected channel and a "Cal Group" (previously created using "Apply" or "Apply to All"). With "Resolve Pool Link", the cal group data are still used as a channel calibration ("Channel Cal") for this channel. With "Remove Pool Link" the channel calibration is removed.

Remote command:

```
MMEMory:LOAD:CORRection:RESolve
```

Ch<n> Calibration Properties/Cal Group <n> Properties

Displays the basic channel settings and the properties of the system error correction for the channel (calibration group) selected in the "Channel State" ("Pool") table.

In addition, it is stated whether sweep data are available for the selected calibration.

Remote command:

```
[SENSe<Ch>:]CORRection:DATE?
```

```
[SENSe<Ch>:]CORRection:DATA:PARAMeter<Sfk>?
```

```
[SENSe<Chn>:]CORRection:SState?
```

10.13 Channel Softtool

The Channel functions select, create and delete channels and optimize the measurement process.

Access: [Channel] hardkey

10.13.1 Channels Tab

Allows you to create and delete channels, to modify the channel state, and to select a channel as the active channel.



You can monitor the channel activity using the `OUTPut<Ch>:UPORt[:VALue]` command and the output signals at pins 8 to 11 of the Aux. Port connector.

The Aux. Port is optional for the R&S ZNL (requires R&S FPL1-B5). It is not available for the R&S ZNLE.



Background information

Refer to [Chapter 9.1.3.3, "Active and Inactive Traces and Channels"](#), on page 189.

10.13.1.1 Controls on the Channels Tab

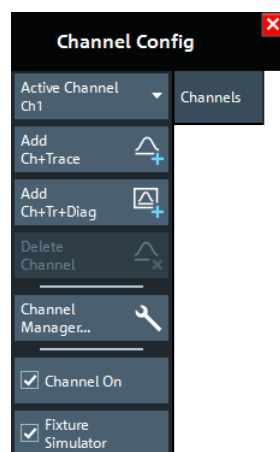

The buttons in the "Channels" tab open the following dialogs:

- "Channel Manager...": see [Chapter 10.13.1.2, "Channel Manager Dialog"](#), on page 486

Active Channel

Selects an arbitrary channel of the active channel setup as the active channel. This function is disabled if the current channel setup contains only one channel.

If one or several traces are assigned to the selected channel, one of these traces becomes the active trace.

The order of all channels in a channel setup is given by the channels' creation time. By default, the channels are named Ch1, Ch2, ... so that Ch<n – 1> precedes Ch<n>. This order is always maintained, even if channels are renamed, invisible (because no traces are assigned to them) or distributed over several diagram areas.

Tip: You can also select a line in the channel list to activate the corresponding channel.

Remote command:

The numeric suffix <Ch> appended to the first-level mnemonic of a command selects a channel as the active channel.

New Channel

Creates a channel and a trace with default settings, and assigns the new trace to the active diagram area.

The new channel is named Ch<n>, where <n> is the largest of all existing channel numbers plus one. The name can be changed in the "Channel Manager" dialog.

Tips:

- To create a channel and a trace with default settings and to display the trace in a *new* diagram area, use [New Channel + Diagram](#).
- Use [Add Trace](#) to create a trace in the *active* channel.

Remote command:

```
CONFigure:CHANnel<Ch>[:STATe] ON
CALCulate<Ch>:PARAmeter:SDEFine
DISPlay[:WINDow<Wnd>]:TRACe<WndTr>:FEED
CONFigure:TRACe<Trc>:CHANnel:NAME?
CONFigure:TRACe<Trc>:CHANnel:NAME:ID?
```

Copy Channel

Copies the active channel with all its settings (including a possible channel calibration) and traces. The new traces are displayed in the active diagram area.

The new channel is named Ch<n>, where <n> is the largest of all existing channel numbers plus one. The name can be changed in the "Channel Manager" dialog.

Tips: Use [Copy Channel + Diagram](#) to display the copied traces in a *new* diagram area.

Remote command:

```
CONFigure:CHANnel<Ch>[:STATe] ON
CALCulate<Ch>:PARAmeter:SDEFine
DISPlay[:WINDow<Wnd>]:TRACe<WndTr>:FEED
CONFigure:TRACe<Trc>:CHANnel:NAME?
CONFigure:TRACe<Trc>:CHANnel:NAME:ID?
```

New Channel + Diagram

Creates a channel and a trace with default settings, and assigns the created trace to a new diagram area.

The new channel is named Ch<n>, where <n> is the largest of all existing channel numbers plus one. The name can be changed in the "Channel Manager" dialog.

Tip: To create a channel and a trace with default settings and to display the trace in the *active* diagram area, use [New Channel](#).

Copy Channel + Diagram

Copies the active channel with all its settings (including a possible channel calibration) and traces, and displays the created traces in a new diagram area.

The new channel is named Ch<n>, where <n> is the largest of all existing channel numbers plus one. The name can be changed in the "Channel Manager" dialog.

Tips: Use [Copy Channel](#) to display the new traces in an *existing* diagram area.

Delete Channel

Deletes the current channel including all the traces assigned to it and removes all display elements related to the channel from the diagram area. "Delete Channel" is disabled if the channel setup contains only one channel: In manual control, each channel setup must contain at least one diagram area with one channel and one trace.

Tips: Use the "Undo" function to restore a channel that was unintentionally deleted.

Remote command:

```
CONFigure:CHANnel<Ch>[:STATe] OFF
```

Channel On

Toggles the measurement state of the [Active Channel](#).

Remote command:

```
CONFigure:CHANnel<Ch>:MEASure[:STATe]
```

Fixture Simulator

The "Fixture Simulator" switch deactivates or activates the configured deembedding, embedding, balanced ports, and port impedance settings for the selected channel.

When "Fixture Simulator" is **deactivated**:

- all balanced ports are resolved to single ended ports
- all port impedances are set to default
- all de/embeddings are disabled

At the GUI, the "Balanced Ports" dialog and the de/embedding tabs and dock widgets are disabled. Related remote commands generate an error.

When "Fixture Simulator" is **reactivated**, the situation before the deactivation is restored.

Note: The "Offset" and "One Way Loss" settings are **not** affected by the "Fixture Simulator" switch. Use the "All Compensation Off"/"All Compensation On" functions of the "Fixture Compensation" dialog to de/activate these compensations as well (see [Chapter 10.14.2.2, "Fixture Compensation Dialog"](#), on page 503).

Remote command:

```
CALCulate<Ch>:TRANSform:VNETworks:FSIMulator[:STATe]
```

10.13.1.2 Channel Manager Dialog

The "Channel Manager" dialog allows you to rename channels and to change their measurement state and sweep mode.

Access: [Channel] > "Channels" > "Channel Manager..."



Background information

Refer to [Chapter 9.1.3.3, "Active and Inactive Traces and Channels"](#), on page 189.

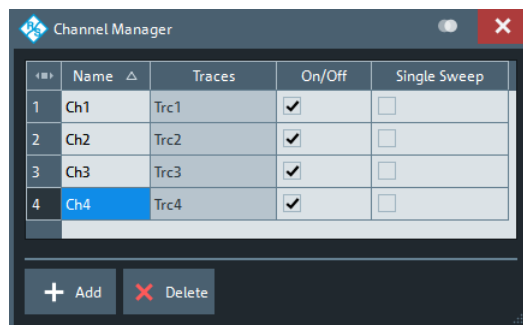

Channel table

The rows and columns of the channel table represent the existing channels (rows) together with certain editable (white) or non-editable (gray) properties (columns).

- "Name" indicates the name of the related channel.
- "Traces" indicates the names of all traces assigned to the related channel.
- "On/Off" toggles the measurement state of the related channel.
- "Single Sweep" toggles between "Continuous" and "Single" sweep mode (see ["Continuous / Single"](#) on page 327).

Remote command:

```
CONFigure:CHANnel:CATalog?
CONFigure:CHANnel<Ch>:NAME
CONFigure:CHANnel<Ch>:NAME:ID?
CONFigure:CHANnel<Ch>:MEASure[:STATe]
INITiate<Ch>:CONTinuous
```

Add / Delete

The buttons below the channel table add and delete channels.

- "Add" adds a new channel to the list. The new channel is named Ch<n>, where <n> is the largest of all existing channel numbers plus one.
- "Delete" deletes the channel selected in the table. This button is disabled if the setup contains only one channel: In manual control, each setup must contain at least one diagram area with one channel and one trace.

Remote command:

```
CONFigure:CHANnel<Ch>[:STATe]
```

10.13.2 Mode Tab

Optimizes the measurement process.

10.13.2.1 Controls on the Mode Tab

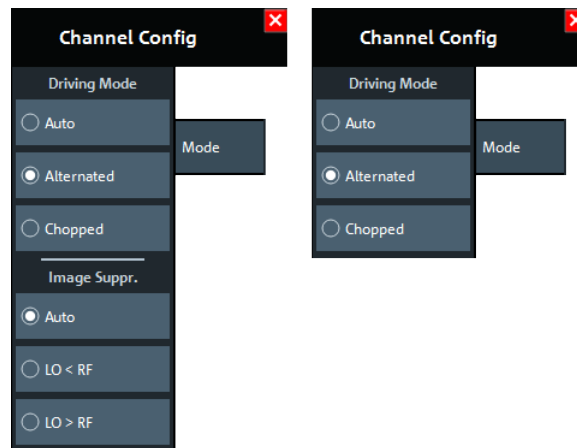

Figure 10-16: Channel > Mode tab

left = R&S ZNL
right = R&S ZNLE

The controls on the "Mode" tab are organized in sections "Driving Mode" and "Image Suppr." (R&S ZNL only).

Driving Mode

Determines the order of partial measurements and sweeps.

- In "Auto" mode, the analyzer optimizes the display update: Fast sweeps are performed in "Alternated" mode, slower sweeps in "Chopped" mode.
- In "Alternated" mode, a partial measurement is performed at all sweep points (partial sweep) before the hardware settings are changed. The next partial measurement is carried out in an additional sweep. This mode is usually faster than "Chopped" mode.
- In "Chopped" mode, the analyzer completes the necessary sequence of partial measurements at each sweep point and obtains the result (measurement point) before proceeding to the next sweep point. A trace is obtained from the beginning of the sweep.

The "Driving Mode" setting is also used during a system error correction. For channels which require a single partial measurement only, the driving mode settings are equivalent. See also [Chapter 9.1.4.1, "Partial Measurements and Driving Mode"](#), on page 190.

Remote command:

`[SENSe<Ch>:]COUPlE`

Image Suppr.

The "Image Suppr." settings define whether the analyzer measures with a local oscillator frequency LO below or above the RF input frequency. This feature can be used to

eliminate known spurious components in the input signal that can distort the measurement, especially in the low frequency range.

- In "Auto" mode, the analyzer auto-selects the LO frequency, depending on the receiver (RF) frequency and the test port. This mode systematically avoids known spurious signals if no frequency conversion occurs in the test setup.
- "LO < RF" means that the LO frequency is always below the measured RF frequency. This mode is appropriate for avoiding single, known spurious signals.
- "LO > RF" means that the LO frequency is always above the measured RF frequency. This mode is appropriate for avoiding single, known spurious signals.

Tip: In the presence of several spurious signals, setting the "Image Suppr." parameter globally can be insufficient. To improve the result, perform a segmented frequency sweep and assign independent LO frequencies to the individual sweep segments.

Note: For the R&S ZNLE, only "Auto" mode is available and hence the "Image Suppr." section is hidden.

Application example

Consider the following test setup with a strongly reflecting DUT (e.g. a bandpass in its stop band) that is measured in transmission. The incident wave a_1 is generated at a frequency RF. The reflected wave b_1 falls into the receiver mixer of the analyzer port 1; a small fraction of the mixer product $RF + 2*IF$ can be reflected back towards the DUT. If this spurious wave a'_1 passes the DUT, then it is received as b'_2 at port 2, together with the wanted signal b_2 .

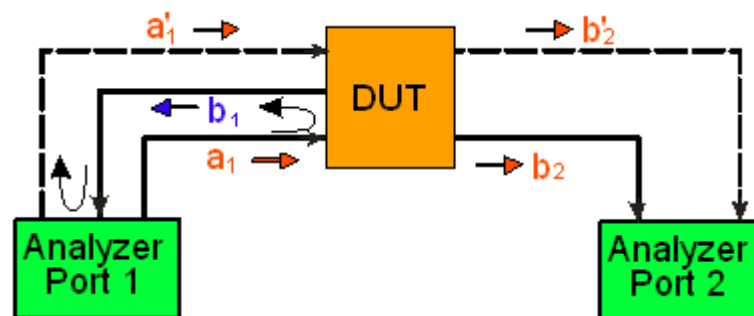

LO > RF implies that LO = RF + IF. The mixer at port 2 converts both the wanted signal b_2 and the spurious signal b'_2 which is at the frequency $RF' = IF + LO$, to the same IF frequency. The response of an ideal, infinitely steep bandpass filter with a pass band between B^- and B^+ looks as follows:

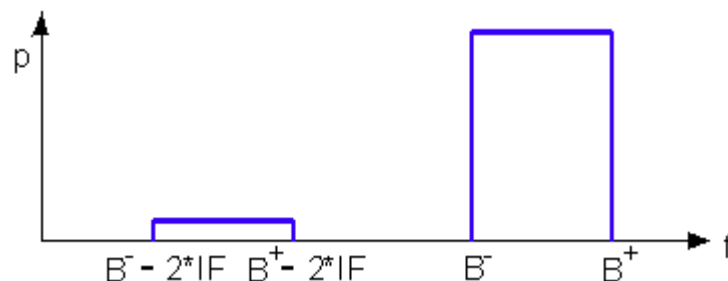

For a wide bandpass, the spurious response flattens the filter edges.

The spurious signal can be eliminated by dividing the sweep range into two segments with different LO settings:

- In the low-frequency segment ranging up to the center frequency of the bandpass filter, the frequency of the local oscillator is set to $LO < RF$. This setting ensures that the spurious signal b'_2 is not measured at port 2.
- In the high-frequency segment, starting at the center frequency of the bandpass filter, the frequency of the local oscillator is set to $LO > RF$. If the center frequency is larger than $B^+ - 2*IF$, then there is no distortion from b'_2 .

Remote command:

[SENSe<Ch>:] FREQuency: SBANd

10.13.3 Channel Bits Tab

Sets a channel-dependent 8-bit decimal value (0 ... 255) to control eight independent output signals at the Aux. Port connector (lines 8 to 11 and 16 to 19).

Setting the channel bits does not change the analyzer state.

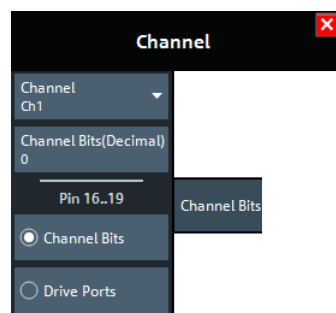

- The Aux. Port is provided by the [Additional Interfaces](#) option R&S FPL1-B5. If the "Additional Interfaces" plugin-unit is not detected, the "Channel Bits" tab is hidden.
- Because the "Additional Interfaces" option is not available for the R&S ZNLE, the "Channel Bits" tab is always hidden on this instrument.
- If the R&S ZNL3|4|6 is equipped with the corresponding "Spectrum Analyzer" option R&S ZNL3|4|6-B1, the VNA Aux. Port functionality can only be used if the "Additional Interfaces" plugin-unit is set to the appropriate mode (see [Chapter 7.4.6](#), "[Additional Interfaces](#)", on page 135).

Channel Bits (Decimal)

Entry of the 8-bit decimal value (0 ... 255) for the selected channel. The channel bits control eight output signals at the Aux. Port connector. The signals are 3.3 V TTL signals which can be used to differentiate between up to 256 independent analyzer states. For an application example, refer to the description of the remote-control command.

The decimal values have the following effect:

- 0 means that no output signals are enabled at any of the pins 8, 9, 10, 11 and 16, 17, 18, 19.

- 1 enables the output signal at pin 8. The signal is switched on while a measurement sweep is running in the selected channel. All other signals are inactive.
- 2 enables the output signal at pin 9.
- 3 enables the output signals at pins 8 and 9.
- ...
- 255 enables the output signals at all pins. See also "Pin 16 - 19" on page 490.

Remote command:

`OUTPut<Ch>:UPORt[:VALue]`

Pin 16 - 19

Selects the control mechanism for the signals at pins 16 to 19 of the Aux. Port connector.

- **"Channel Bits"**: Signals are controlled by channel bits 4 to 7. No drive port indication at the Aux. Port connector.
- **"Drive Ports"**: Signals indicate the active drive ports. The number of active channel bits is reduced to 4 (pins 8 to 11).

Remote command:

`OUTPut:UPORt:ECBits`

10.14 Offset Embed Softtool

The "Offset Embed" softtool allows you to define a length offset and loss for each test port. The offset compensates for the known length and loss of (non-dispersive and perfectly matched) transmission lines between the calibrated reference plane and the DUT. It also contains advanced functions for deembedding/embedding the DUT from/into more general physical/virtual (matching) networks placed between the calibrated reference plane and the DUT.

Access: [Offset Embed]



Background information

Refer to [Chapter 9.6, "Offset Parameters and De-/Embedding"](#), on page 265

10.14.1 Offset Embed Dock Widget

On activating a tab in the "Offset Embed" softtool, a dock widget is displayed beneath the trace area, whose content pane is synchronized with the selected softtool tab.

Access: [Offset Embed]

10.14.1.1 Overview Panel

Shows an overview of the overall calculation flow and provides quick access to the "Offset Embed" functions.

Access: [Offset Embed] > "Overview"

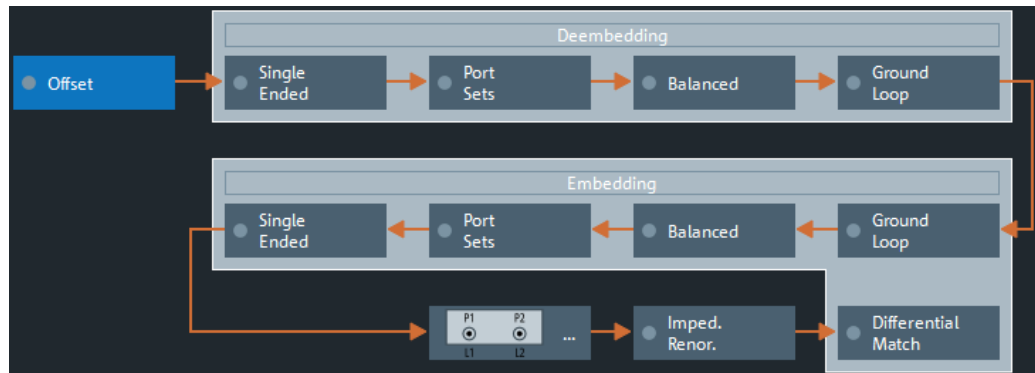

Figure 10-17: Offset Embed dock widget: Overview (Calculation Flow)

Use one of the buttons to configure the corresponding function. A green LED on a button indicates that the corresponding deembedding/embedding function is active.



If the "Fixture Simulator" is disabled for the related channel (see "Fixture Simulator" on page 485), all functions except the "Offset" function are in inactive (grayed out in the "Overview").

10.14.1.2 Offset Panel

Allows you to activate or deactivate offset/loss correction for selected physical ports and to set related parameters.

Access: Overview Panel > "Offset"

Offset									
Offset	Active	Delay	Loss at DC	Loss at 1st Freq	1st Freq for Loss	Use 2nd Freq	Loss at 2nd Freq	2nd Freq for Loss	
P1 L1	<input checked="" type="checkbox"/>	0 s	0 dB	0 dB	1 GHz	<input type="checkbox"/>	0 dB	500 MHz	Reset Offsets All Offsets On All Offsets Off Displayed Columns...
P2 L2	<input checked="" type="checkbox"/>	0 s	0 dB	0 dB	1 GHz	<input type="checkbox"/>	0 dB	500 MHz	

Figure 10-18: Offset Embed dock widget: Offset panel

The "Offset" panel can also be activated by selecting the [Offset Tab](#) or [One Way Loss Tab](#). Refer to its description for additional functions and remote commands.

Active

The checkbox in the "Active" column activates/deactivates the configured length and loss parameters for the respective [Port](#) (i.e. adds/removes them to/from the calculation flow) without changing the parameter values.

Remote command:

```
[SENSe<Ch>:]CORRection:OFFSet<PhyPt>:COMPensation[:STATe]
```

Loss at DC / Loss at 1st Freq / 1st Freq for Loss / Use 2nd Freq / Loss at 2nd Freq / 2nd Freq for Loss

Defines the one-way loss parameters of the transmission line at the selected port.

In the limit case, where the length of the transmission line is considered to be "almost zero", the loss is considered constant:

$$Loss(f) = Loss_{DC}$$

Otherwise, if the loss at DC and one additional frequency f_1 is known, the loss at frequency f is approximated by:

$$Loss(f) = Loss_{DC} + (Loss(f_1) - Loss_{DC}) \cdot \sqrt{\frac{f}{f_1}}$$

If, in addition, the loss at a second frequency f_2 is known and "Use 2nd Freq" is enabled, then the loss is approximated by:

$$Loss(f) = Loss_{DC} + (Loss(f_1) - Loss_{DC}) \cdot \left(\frac{f}{f_1}\right)^b, \text{ where } b = \frac{\log_{10}\left(\left|\frac{Loss(f_1)}{Loss(f_2)}\right|\right)}{\log_{10}\left(\frac{f_1}{f_2}\right)}$$

See also [Chapter 9.6.1.2, "Definition of Loss Parameters"](#), on page 266.

Note: The entered parameters define the loss for a signal traveling in **one direction** through the transmission line. To account for the propagation in both directions, the magnitude shift of a reflection parameter due to a given loss is twice the magnitude shift of a transmission parameter. See also [Chapter 9.6.1.6, "Application and Effect of Offset Parameters"](#), on page 270.

Remote command:

```
[SENSe<Ch>:]CORRection:LOSS<PhyPt>:OFFSet
[SENSe<Ch>:]CORRection:LOSS<PhyPt>
[SENSe<Ch>:]CORRection:LOSS<PhyPt>:FREQuency
[SENSe<Ch>:]CORRection:LOSS<PhyPt>:SECond:STATe
[SENSe<Ch>:]CORRection:LOSS<PhyPt>:SECond
[SENSe<Ch>:]CORRection:LOSS<PhyPt>:SECond:FREQuency
```

Reset Offsets

The "Reset Offsets" button resets the length and loss parameters for all ports to their default values.

Remote command:

```
[SENSe<Ch>:]CORRection:OFFSet<PhyPt>[:STATe]
```

All Offsets On / All Offsets Off

Activates/deactivates the length and loss compensation for all ports.

Use the checkboxes in the [Active](#) column to activate/deactivate the length and loss compensation for selected ports.

Remote command:

```
[SENSe<Ch>:]CORRection:OFFSet<PhyPt>:COMPensation[:STATe]
```

Displayed Columns

Opens a dialog that lets you select between different ways to specify the offset, similar to [Delay / Electrical Length / Mech. Length](#) on the [Offset Tab](#).

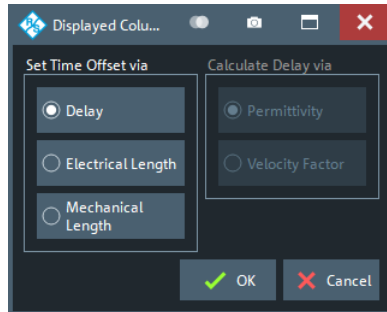

10.14.1.3 Single Ended Panel

Allows you to activate or deactivate single ended deembedding/embedding for selected physical ports. For the "2-Port Data" network type, it is also possible to change the underlying s_{2p} Touchstone file from the dock widget.

Access: [Overview Panel](#) > "Single Ended"

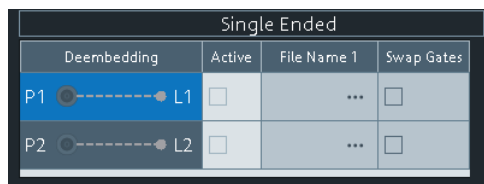

The "Single Ended" panel can also be activated by selecting the [Single Ended Tab](#) softtool tab. Refer to its description for background information, parameters and additional remote commands.

Active

The checkbox in the "Active" column activates or deactivates the selected "Single Ended" de-/embedding [Single Ended Tab](#) (i.e. adds or removes it to/from the calculation flow) without changing its parameters.

Remote command:

```
CALCulate<Ch>:TRANSform:VNETworks:SENDED:DEEMbedding<PhyPt>[:STATE]
```

```
CALCulate<Ch>:TRANSform:VNETworks:SENDED:EMBedding<PhyPt>[:STATE]
```

File Name 1 / Swap Gates

The ellipsis button in the "File Name 1" column is enabled as long as the "2-Port Data" network is selected (see [Single Ended Tab](#)). This network is defined by its S-parameters stored in a two-port Touchstone file (* .s2p). No additional parameters are required.

When loading the touchstone file, the analyzer by default assumes odd ports left (VNA side), even ports right (DUT side). However, it is also possible to **"Swap Gates"**, instructing the analyzer to reinterpret the loaded S-parameters (e.g. $S_{12} \rightarrow S_{21}$).

Note: The loaded S-parameters are stored in the active channel setup. Channel set-ups contain the full embedding and deembedding data so that they can be transferred to other instruments.

Remote command:

```
MMEMory:LOAD:VNETworks<Ch>:SENDEd:DEEMbedding<PhyPt>
```

```
MMEMory:LOAD:VNETworks<Ch>:SENDEd:EMBedding<PhyPt>
```

10.14.1.4 Port Sets Panel

The "Port Sets" panel allows you to configure the "Port Sets" to whom a deembedding or embedding network can be assigned ("Add", "Delete"). The touchstone files defining these networks can also be selected from here ("...").

Access: [Overview Panel](#) > "Port Sets"

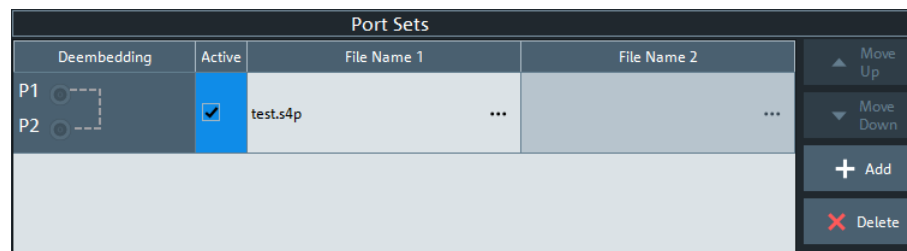

The "Port Sets" panel can also be activated by selecting the [Port Sets Tab](#). Refer to its description for background information, parameters and additional remote commands.

Move Up / Move Down

Allows you to modify the sequence in which the active port set deembeddings/embeddings are applied.

Add / Delete

Allows you to define the "Port Sets" to whom a deembedding or embedding network can be assigned.

The "Add" button opens the "Define Port Set" dialog that allows you to define an additional port set, comprising two ports (in arbitrary order).

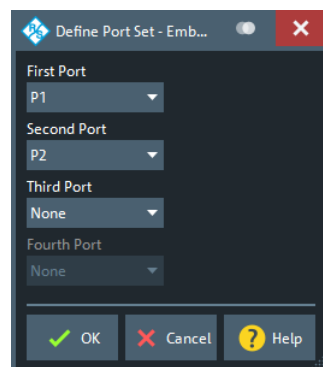

Use the controls on the right-hand side of the dialog to define the port set and the order of the ports within the port set.

Remote command:

```
CALCulate<Ch>:TRANSform:VNETworks:PPAir:DEEMbedding<ListId>:
```

```
DEFine
```

```
CALCulate<Ch>:TRANSform:VNETworks:PSET:DEEMbedding<ListId>:
```

```
DEFine
```

```
CALCulate<Ch>:TRANSform:VNETworks:PPAir:DEEMbedding:DELeTe
```

```
CALCulate<Ch>:TRANSform:VNETworks:PPAir:EMBedding<ListId>:DEFine
```

```
CALCulate<Ch>:TRANSform:VNETworks:PSET:EMBedding<ListId>:DEFine
```

```
CALCulate<Ch>:TRANSform:VNETworks:PPAir:EMBedding<ListId>:DELeTe
```

Active

The checkboxes in the "Active" column activate or deactivate the configured de-/embedding for the related port set (i.e. adds or removes it to/from the calculation flow) without changing its parameters.

Remote command:

```
CALCulate<Ch>:TRANSform:VNETworks:PPAir:DEEMbedding<ListId>[:
```

```
STATe]
```

```
CALCulate<Ch>:TRANSform:VNETworks:PPAir:EMBedding<ListId>[:
```

```
STATe]
```

File Name <i>/Inc. Seq. <i>

The "File Name 1" (and "File Name 2") buttons are enabled as long as the selected deembedding/embedding [Port Sets Tab](#) is defined using one or two Touchstone file(s).

When loading a touchstone file, the analyzer by default assumes odd ports left (VNA side), even ports right (DUT side). However, it is also possible to instruct the analyzer to assume an "Increasing Port Sequence", i.e. that the low port numbers are on the VNA side. Furthermore it is possible to "Swap Gates", i.e. to instruct the analyzer to swap the VNA and DUT side.

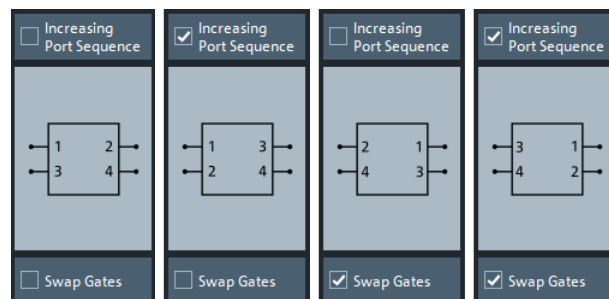

Note: The loaded file is stored in the active channel setup. Persisted channel setups contain the full (de-)embedding data so that they can be transferred to other instruments.

Remote command:

```
MMEMory:LOAD:VNETworks<Ch>:PPAir:DEEMbedding<ListId>
```

```
MMEMory:LOAD:VNETworks<Ch>:PPAir:EMBedding<ListId>
```

10.14.1.5 Balanced Panel

This panel allows you to activate or deactivate deembedding/embedding of balanced ports.

Access: [Overview Panel](#) > "Balanced"

If the selected [Balanced Tab](#) is defined using a touchstone file, this file can be selected from the dock widget ("...").

For network types that are defined using one or more touchstone files, the required files can also be selected from here ("...").

If necessary, use the button on the right-hand side to open the [Balanced Ports Dialog](#) and change the balanced port configuration.

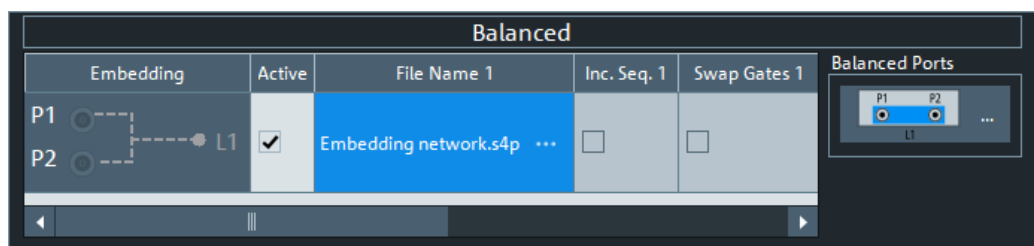

This panel can also be activated by selecting the [Balanced Tab](#). Refer to its description for background information, parameters and additional remote commands.

Active

The checkboxes in the "Active" column activate or deactivate the configured de-/embedding for the related balanced port (i.e. adds or removes it to/from the calculation flow) without changing its parameters.

Remote command:

```
CALCulate<Ch>:TRANSform:VNETworks:BALanced:DEEMbedding<LogPt>[:STATE]
```

```
CALCulate<Ch>:TRANSform:VNETworks:BALanced:EMBedding<LogPt>[:STATE]
```

File Name <i>/Swap Gates

The ellipsis button in the "File Name <i>" column is enabled as long as the selected [Balanced Tab](#) comprises a two-port or four-port data network (*.s2p or *.s4p file).

When loading a touchstone file, the analyzer by default assumes odd ports left (VNA side), even ports right (DUT side). However, it is also possible to instruct the analyzer to assume an "Increasing Port Sequence", i.e. that the low port numbers are on the VNA side. Furthermore it is possible to "Swap Gates", i.e. to instruct the analyzer to swap the VNA and DUT side.

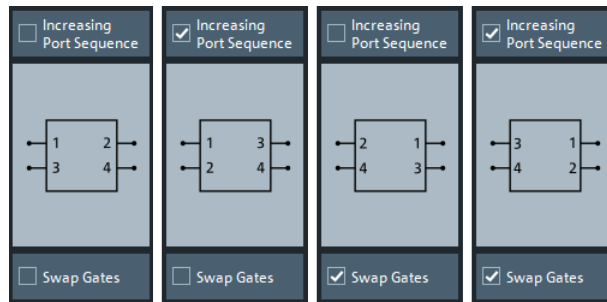

Note: The loaded S-parameters are stored in the active channel setup. Persisted channel setups contain the full embedding and deembedding data so that they can be transferred to other instruments.

Remote command:

`MMEMory:LOAD:VNETworks<Ch>:BALanced:DEEMbedding<LogPt>`

`MMEMory:LOAD:VNETworks<Ch>:BALanced:EMBedding<LogPt>`

Balanced Ports

Provides access to the [Balanced Ports Dialog](#) that allows you to modify the balanced port configuration.

10.14.1.6 Ground Loop Panel

Allows you to activate or deactivate ground loop deembedding/embedding ("Active").

Access: [Overview Panel](#) > "Ground Loop"

For the "1-Port Data" network type, the required touchstone file can also be selected from here ("...").

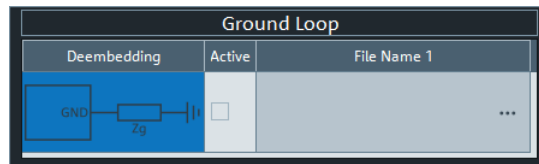

This panel can also be activated by selecting the [Ground Loop Tab](#) softtool tab. Refer to its description for background information, parameters and additional remote commands.

Active

The checkboxes in the "Active" column activate or deactivate the configured ground loop deembedding/embedding (i.e. adds or removes it to/from the calculation flow) without changing its parameters.

Remote command:

`CALCulate<Ch>:TRANSform:VNETworks:GLOop:DEEMbedding[:STATe]`

`CALCulate<Ch>:TRANSform:VNETworks:GLOop:EMBedding[:STATe]`

File Name 1

The ellipsis button in the "File Name 1" column is enabled if a 1-port data [Network](#) network (*.slp file) is selected.

Note: The loaded S-parameter trace is stored in the active channel setup. Persisted channel setups contain the full embedding and deembedding data so that they can be transferred to other instruments.

Remote command:

MMEMory:LOAD:VNETworks<Ch>:GLOop:DEEMbedding

MMEMory:LOAD:VNETworks<Ch>:GLOop:EMBedding

10.14.1.7 Impedance Renormalization Panel

This panel provides alternative access to the reference impedance settings (see ["Reference Impedance Tab"](#) on page 381).

Access: [Overview Panel](#) > "Impedance Renor."

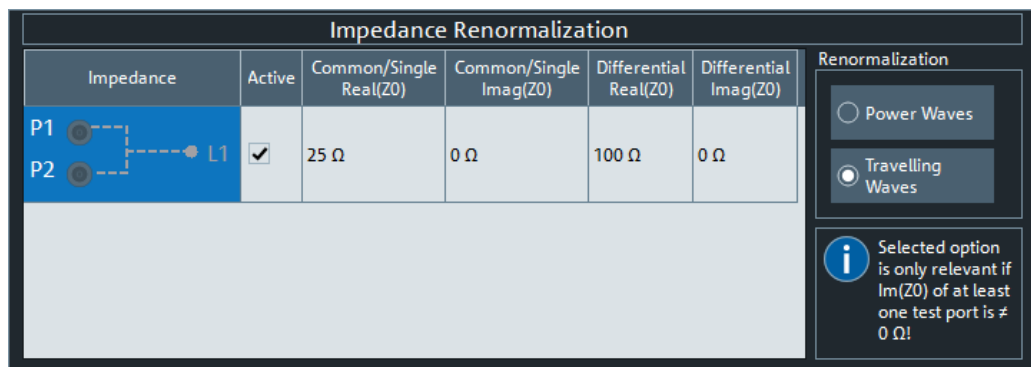
**Active**

The "Active" flags are inversely related to the [Use Default](#) flags of the logical port configuration (see [Balanced Ports Dialog](#)).

"Active"	"Use Default"
<input checked="" type="checkbox"/>	<input type="checkbox"/>
<input type="checkbox"/>	<input checked="" type="checkbox"/>

10.14.1.8 Differential Match Panel

This panel allows you to activate or deactivate differential match embedding.

Access: [Overview Panel](#) > "Differential Match"

For the "2-Port Data" network type, the required touchstone file can also be selected from here ("...").

If necessary, use the button on the right hand side to open the [Balanced Ports Dialog](#) and change the balanced port configuration.

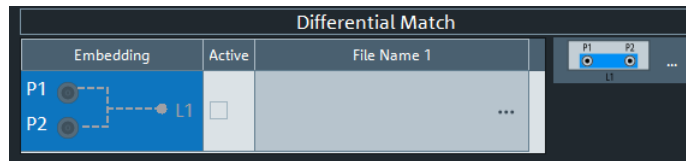

This panel can also be activated by selecting the [Differential Match Tab](#) softtool tab. Refer to its description of this softtool tab for background information, parameters and additional remote commands.

Active

The checkboxes in the "Active" column activate or deactivate the configured differential match embedding (i.e. adds or removes it to/from the calculation flow) without changing its parameters.

Remote command:

```
CALCulate<Ch>:TRANSform:VNETworks:DIFFerential:
EMBedding<LogPt>[:STATE]
```

File Name 1

The ellipsis button in the "File Name 1" column is enabled if a 2-port data [Network](#) is selected.

When loading the touchstone file (*.s2p), the analyzer by default assumes odd ports left (VNA side), even ports right (DUT side). However, it is also possible to **"Swap Gates"**, instructing the analyzer to reinterpret the loaded S-parameters (e.g. S_{12} --> S_{21}).

Note: The loaded S-parameter traces are stored in the active channel setup. Persisted channel setups contain the full embedding and deembedding data so that they can be transferred to other instruments.

Remote command:

```
MMEMory:LOAD:VNETworks<Ch>:DIFFerential:EMBedding<LogPt>
```

10.14.2 Offset Tab

Defines length offset parameters for each port.

Use the complementary dock widget to activate or deactivate length/loss compensation for selected ports (see [Chapter 10.14.1.2, "Offset Panel"](#), on page 491).



The marker function [Zero Delay at Marker](#) function overwrites the offset parameters.



Background information

Refer to the following sections.

- [Chapter 9.6, "Offset Parameters and De-/Embedding"](#), on page 265
- [Chapter 9.6.1.1, "Definition of Offset Parameters"](#), on page 266
- [Chapter 9.6.1.3, "Auto Length"](#), on page 267
- [Chapter 9.6.1.6, "Application and Effect of Offset Parameters"](#), on page 270
- [Chapter 9.6.1.7, "Offset Parameters for Balanced Ports"](#), on page 271
- [Chapter 9.6.1.5, "Fixture Compensation"](#), on page 269

10.14.2.1 Controls on the Offset Tab

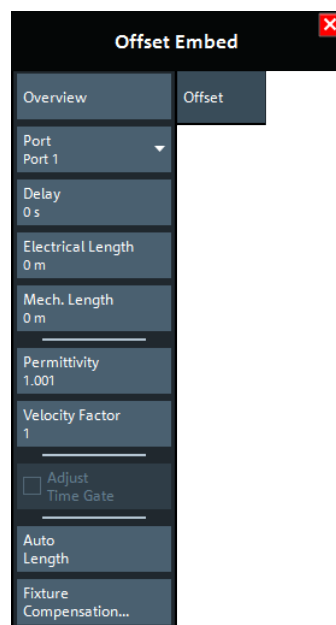

Overview

This button is available on all "Offset Embed" softtool tabs. It opens the [Overview Panel](#) in the [Offset Embed Dock Widget](#).

Port

Physical test port of the analyzer. You can define independent offset parameters for all ports.

Remote command:

The <PhyPt> numeric suffix in the [SENSe<Ch>:]CORRection:... commands identifies the physical port.

Delay / Electrical Length / Mech. Length

Defines the length offset at the selected port as a delay, an electrical length, or a mechanical length. The three quantities are related by:

$$Delay = \frac{L_{mech} \cdot \sqrt{\epsilon_r}}{c}; \text{ Electrical Length} = L_{mech} \cdot \sqrt{\epsilon_r}$$

and overwrite each other. See also [Chapter 9.6.1.1, "Definition of Offset Parameters"](#), on page 266.

Note: The entered parameters must correspond the actual (one-way) length of the transmission line. To account for the propagation in both directions, the phase shift of a reflection parameter due to a given length offset is twice the phase shift of a transmission parameter. For a numeric example, see [Chapter 9.6.1.6, "Application and Effect of Offset Parameters"](#), on page 270.

Remote command:

```
[SENSe<Ch>:]CORRection:EDELay<PhyPt>[:TIME]
[SENSe<Ch>:]CORRection:EDELay<PhyPt>:ELENgth
[SENSe<Ch>:]CORRection:EDELay<PhyPt>:DISTance
```

Permittivity / Velocity Factor

Defines the permittivity (ϵ_r) and velocity factor of the dielectric in the transmission line between the reference plane and the DUT. The velocity factor is $1/\sqrt{\epsilon_r}$ and is a measure for the velocity of light in a dielectric with permittivity ϵ_r relative to the velocity of light in the vacuum (velocity factor < 1). Permittivity and velocity factor are coupled parameters.

See also [Chapter 9.6.1.1, "Definition of Offset Parameters"](#), on page 266.

Remote command:

```
[SENSe<Ch>:]CORRection:EDELay<PhyPt>:DIElectric
```

Adjust Time Gate

Activates the operating mode where the time gate is moved in the opposite direction when the "Delay" setting (or any other length offset parameter) is changed. The button is available if a time gate is active (see ["Time Gate"](#) on page 350). In time domain, a positive delay shifts the time gate to the left, a negative delay shifts it to the right.

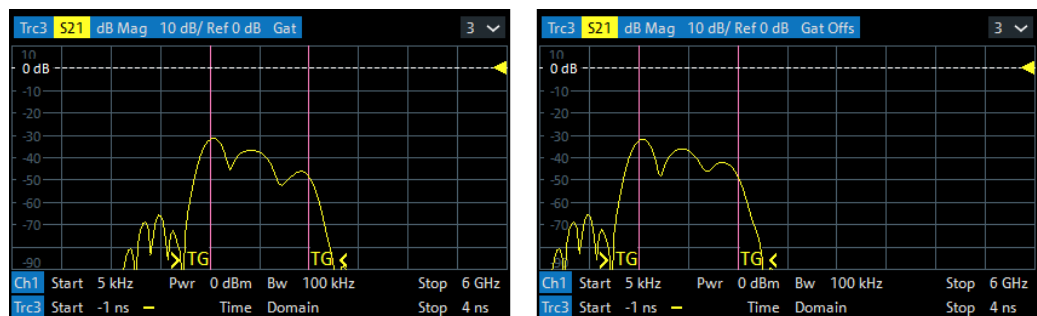

left = no delay
right = delay 1 ns

The position of the time gate is always relative to the end of the offset transmission line. As a consequence, "Adjust Time Gate" allows measurements at variable offset but fixed time gate position.

Example: The impedance of an antenna with possible faults is measured using a time gate and a variable length offset. If "Adjust Time Gate" is off, the time gate is at a constant distance from the offset-corrected reference plane (end of the offset transmission line). Its absolute position is varied along with the length offset.

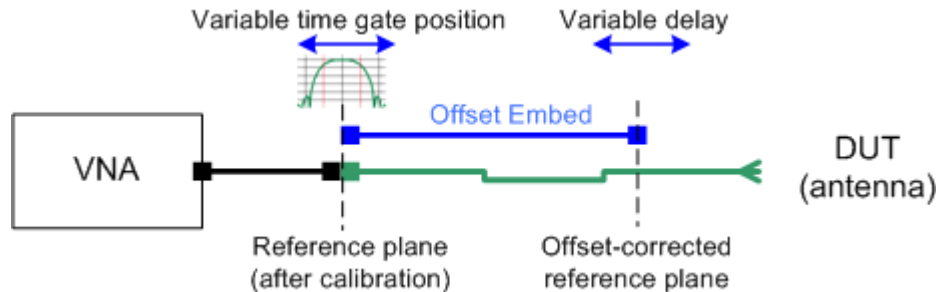

If "Adjust Time Gate" is on, the time gate is moved to left (right) when the offset-corrected reference plane is moved to the right (left). Its absolute position remains fixed. With this setting, it is possible, e.g., to keep the time gate at the position of the antenna connector while the antenna is measured at different length offsets.

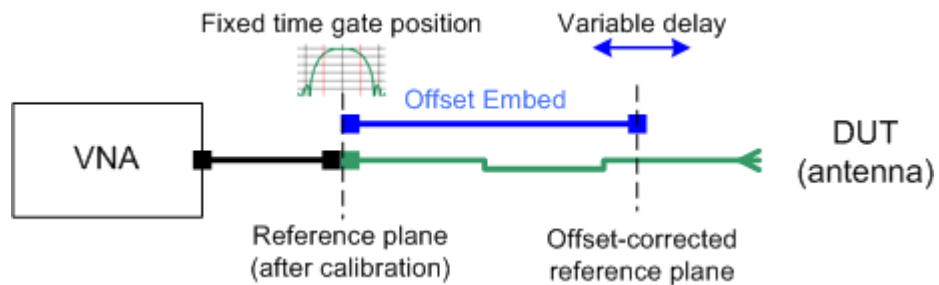

Remote command:

```
CALCulate:FILTer[:GATE]:TIME:AOFFset
```

Auto Length

Calculates the electrical length offset for the receive port of the active trace. See [Chapter 9.6.1.3, "Auto Length"](#), on page 267.

If "Delay" is the selected trace format, the entire trace is shifted in vertical direction and centered on zero. In phase format, the "Auto Length" corrected trace shows the deviation from linear phase.

Use [Evaluation Range...](#) to limit the frequency range for the calculation.

Note that in order to calculate the electrical length offset of port i , you have to select a trace that uses port i as one of its receive ports. It is **not** relevant for the "Auto Length" function which [Port](#) is selected.

If the measured quantity is a ratio, or if it is derived from a ratio, its receiving port is given as the index of the wave quantity in the numerator. If the active trace shows an S-parameter S_{ij} , then "Auto Length" adds a length offset at port i . If the receive port is balanced, then the same offset is applied to both its physical ports.

Remote command:

```
[SENSe<Ch>:]CORRection:EDELay:AUTO
```

Fixture Compensation...

The "Fixture Compensation..." button opens the [Fixture Compensation Dialog](#).

Evaluation Range...

The "Evaluation Range..." button opens the [Evaluation Range Dialog](#) that allows you to restrict the frequency range of auto length (and loss) calculations.

10.14.2.2 Fixture Compensation Dialog

This dialog allows you to correct the measurement result for the effects of a test fixture.

Access:

- [Offset Embed] > "Offset" > "Fixture Compensation..."
- [Offset Embed] > "One Way Loss" > "Fixture Compensation..."

**Background Information**

Refer to [Chapter 9.6.1.5, "Fixture Compensation"](#), on page 269.

**Ports**

Selects the ports for whom fixture compensation data shall be acquired.

Auto Length / Auto Length and Loss

"Auto Length" or "Auto Length and Loss" implies that a global electrical length offset and loss is determined in analogy to the general offset compensation (see [Chapter 9.6.1.3, "Auto Length"](#), on page 267 and [Chapter 9.6.1.4, "Auto Length and Loss"](#), on page 268).

Remote command:

```
[SENSe:]CORRection:COLLect:FIXTure:LMPArAmeter:LOSS[:STATe]
```

Direct Compensation

With "Direct Compensation", a frequency-dependent transmission factor is calculated; see ["Auto Length and Loss vs. Direct Compensation"](#) on page 270.

Remote command:

```
[SENSe:]CORRection:COLLect:FIXTure:LMParameter[:STATe]
[SENSe<Ch>:]CORRection:OFFSet<PhyPt>:DFComp[:STATe]?
```

Prompt for Each Port

Determines how the R&S ZNL/ZNLE performs the sweeps for a given termination type (Open and/or Short; see ["Measurement Type"](#) on page 504).

- If unchecked, it performs the sweeps for Open/Short without interruption, implicitly assuming that **all** ports are terminated accordingly
- If checked, it interrupts the data acquisition process after each port, which allows you to modify the test setup (e.g. terminate the next measured port).

Measurement Type

The "Open", "Short", and "Open and Short" buttons bring up the ["Measure Fixture wizard"](#) dialog that guides you through the actual fixture measurement. See ["Open/Short vs. Open and Short compensation"](#) on page 270.

Measure Fixture wizard

The "Measure Fixture" dialog guides you through the previously configured fixture compensation measurements.

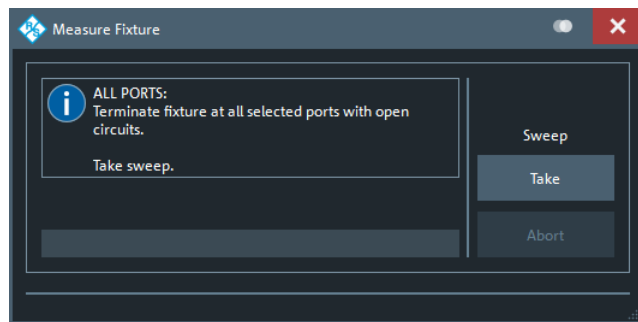
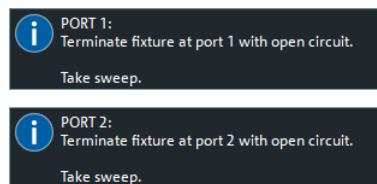

Figure 10-19: Measure Fixture dialog: Auto Length (and Loss)

To acquire the necessary data, proceed as indicated in the information area.

With Prompt for Each Port disabled, "Take" acquires data for all selected ports in one go. Otherwise sweeps are taken port by port.



For "Direct Compensation", it is also possible to save the acquired data to file. In future measurements, you can load these files instead of repeating the data acquisition.

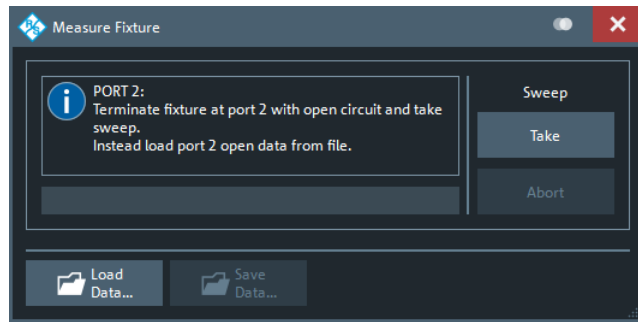

Figure 10-20: Measure Fixture dialog: Direct Compensation (and Prompt for Each Port)

"Direct Compensation" data files are standard trace files, containing reflection parameter traces for the related port and standard:

Table 10-3: Direct Compensation data

Prompt for Each Port	File Type	Description
disabled	csv	One csv trace file per standard, containing reflection traces for all selected ports; see Chapter 9.4.2.2, "ASCII (*.csv) Files" , on page 245
enabled	s1p	One 1-port Touchstone file per standard and port (see Chapter 9.4.2.1, "Touchstone Files" , on page 239)

Tip: Remote control provides additional flexibility. You can:

- Measure the same ports repeatedly without changing the standards and attribute the results to different channels.
- Calculate the compensation data for different ports, using mixed Open and Short standards.

Refer to the program example for `[SENSe<Ch>:]CORRection:COLLect:FIXTure[:ACquire]`.

Remote command:

```
[SENSe<Ch>:]CORRection:COLLect:FIXTure:START
[SENSe<Ch>:]CORRection:COLLect:FIXTure[:ACquire]
[SENSe<Ch>:]CORRection:COLLect:FIXTure:SAVE
[SENSe<Ch>:]CORRection:COLLect:FIXTure:EXPort
[SENSe<Ch>:]CORRection:COLLect:FIXTure:IMPort
```

10.14.3 One Way Loss Tab

Defines loss parameters for each physical port.

Use the complementary dock widget to activate or deactivate length/loss compensation for selected ports (see [Chapter 10.14.1.2, "Offset Panel"](#), on page 491).



Background information

Refer to the following sections.

- [Chapter 9.6, "Offset Parameters and De-/Embedding"](#), on page 265
- [Chapter 9.6.1.2, "Definition of Loss Parameters"](#), on page 266
- [Chapter 9.6.1.4, "Auto Length and Loss"](#), on page 268
- [Chapter 9.6.1.5, "Fixture Compensation"](#), on page 269

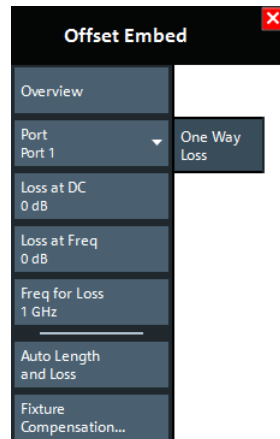

Overview

See ["Overview"](#) on page 500.

Port

Physical test port of the analyzer. You can define independent loss parameters for all ports.

Remote command:

The <PhyPt> numeric suffix in the [SENSe<Ch>:]CORRection:... commands identifies the physical port.

Loss at DC / Loss at 1st Freq / 1st Freq for Loss

See ["Loss at DC / Loss at 1st Freq / 1st Freq for Loss / Use 2nd Freq / Loss at 2nd Freq / 2nd Freq for Loss"](#) on page 492.

Auto Length and Loss

Determines the length offset and one-way loss parameters for the receive port of the active trace. See [Chapter 9.6.1.4, "Auto Length and Loss"](#), on page 268.

Use [Evaluation Range...](#) to limit the frequency range for the calculation.

Note:

- If "Auto Length and Loss" is used with a line connected to a test port, the end of the line should be left open.
- To calculate the electrical length offset and loss of port *i*, you have to select a trace that uses port *i* as one of its receive ports. It is **not** relevant for the "Auto Length and Loss" function which [Port](#) is selected.

If the measured quantity is a ratio, or if it is derived from a ratio, its receiving port is given as the index of the wave quantity in the numerator. If the active trace shows an S-parameter S_{ij} , then "Auto Length" adds a length offset at port i . If the receive port is balanced, then the same offset and length is applied to both its physical ports.

Remote command:

```
[SENSe<Ch>:]CORRection:LOSS:AUTO
```

Fixture Compensation...

The "Fixture Compensation..." button opens the [Fixture Compensation Dialog](#).

Evaluation Range...

The "Evaluation Range..." button opens the [Evaluation Range Dialog](#) that allows you to restrict the frequency range of auto length (and loss) calculations.

10.14.4 Single Ended Tab

Allows you to specify 2-port deembedding/embedding networks for each physical port.

Such a network is either defined:

- via its S-parameters stored in a two-port Touchstone file (*.s2p) or
- by selecting a predefined lumped element model and specifying the available parameters (resistances/conductances, capacitances, inductances)

See [Chapter 9.6.2.3, "Circuit Models for 2-Port Networks"](#), on page 273.

Use the complementary dock widget to activate or deactivate deembedding/embedding for selected ports (see [Chapter 10.14.1.3, "Single Ended Panel"](#), on page 493).



Background information

Refer to the section [Chapter 9.6.2.9, "Combining Several De-/Embedding Networks"](#), on page 279.

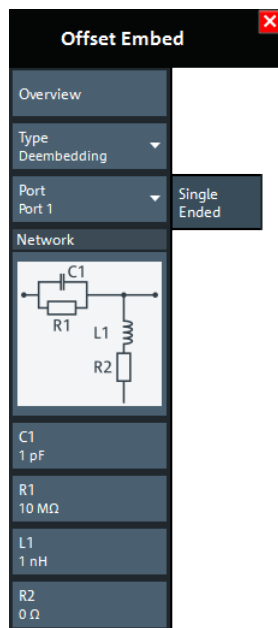

If the "Fixture Simulator" is disabled for the related channel (see "Fixture Simulator" on page 485), this tab is inactive, i.e. all controls except the "Overview" button are grayed out.

Overview

See "Overview" on page 500.

Type

Switches between "Deembedding" and "Embedding" network definition.

Port

Physical port. The transformation networks are defined such that the analyzer is connected to the left of the circuit while the DUT is connected to the right side. You can define independent transformation networks for all ports.

Remote command:

The <PhyPt> numeric suffix in the embedding/deembedding commands identifies the physical port; see e.g. `CALCulate<Ch>:TRANSform:VNETworks:SENDED:DEEMbedding<PhyPt>[:STATe]` or `CALCulate<Ch>:TRANSform:VNETworks:SENDED:EMBedding<PhyPt>[:STATe]`.

All Deembedding Activated

Deactivates or activates all deembeddings (single-ended, balanced, port set, ground loop) for the active channel, if any.

This control is only visible if **Type** = "Deembedding".

Remote command:

n.a.

Network

The graphical list contains all available 2-port networks:

- The  symbol selects "no network" and disables single-ended de-/embedding.
- The "2-Port Data" network is defined by means of imported S-parameter data; see [Select File...](#)
- The remaining networks are defined by lumped elements. Their parameters are displayed below the graphical list.

Tip: Drag and drop the network symbols in horizontal or vertical direction to switch to the next symbol. The lumped elements are numbered from top to bottom.

Remote command:

```
CALCulate<Ch>:TRANSform:VNETworks:SENDED:DEEMbedding<PhyPt>[:
STATE]
```

```
CALCulate<Ch>:TRANSform:VNETworks:SENDED:DEEMbedding<PhyPt>:
TNDefinition
```

```
CALCulate<Ch>:TRANSform:VNETworks:SENDED:DEEMbedding<PhyPt>:
PARAMeters:C<Cmp>
```

```
CALCulate<Ch>:TRANSform:VNETworks:SENDED:DEEMbedding<PhyPt>:
PARAMeters:G<Cmp>
```

```
CALCulate<Ch>:TRANSform:VNETworks:SENDED:DEEMbedding<PhyPt>:
PARAMeters:L<Cmp>
```

```
CALCulate<Ch>:TRANSform:VNETworks:SENDED:DEEMbedding<PhyPt>:
PARAMeters:R<Cmp>
```

```
CALCulate<Ch>:TRANSform:VNETworks:SENDED:EMBedding<PhyPt>[:
STATE]
```

```
CALCulate<Ch>:TRANSform:VNETworks:SENDED:EMBedding<PhyPt>:
TNDefinition
```

```
CALCulate<Ch>:TRANSform:VNETworks:SENDED:EMBedding<PhyPt>:
PARAMeters:C<Cmp>
```

```
CALCulate<Ch>:TRANSform:VNETworks:SENDED:EMBedding<PhyPt>:
PARAMeters:G<Cmp>
```

```
CALCulate<Ch>:TRANSform:VNETworks:SENDED:EMBedding<PhyPt>:
PARAMeters:L<Cmp>
```

```
CALCulate<Ch>:TRANSform:VNETworks:SENDED:EMBedding<PhyPt>:
PARAMeters:R<Cmp>
```

Select File...

"Select File..." is enabled as long as the "2-Port Data" network is selected. This network is defined by its S-parameters stored in a two-port Touchstone file (*.s2p). No additional parameters are required.

In case the port number conventions of the loaded two-port Touchstone file differ from network analyzer conventions (port 1 on the left, i.e. on the analyzer side; port 2 on the right, i.e. on the DUT side), it is possible to "Swap Gates". The analyzer will interchange the port numbers (e.g. $S_{12} \rightarrow S_{21}$) when loading the file.

Note: The loaded file is stored in the active channel setup. Channel setups contain the full (de-)embedding data so that they can be transferred to other instruments.

Remote command:

`MMEemory:LOAD:VNETworks<Ch>:SENDEd:DEEMbedding<PhyPt>`

`MMEemory:LOAD:VNETworks<Ch>:SENDEd:EMBedding<PhyPt>`

10.14.5 Port Sets Tab

Selects transformation networks for deembedding/embedding arbitrary port sets, defines their parameters, assigns them to a port set and enables embedding.

Use the complementary dock widget to create the required port sets and to activate or deactivate dembedding/embedding for selected port sets (see [Chapter 10.14.1.4, "Port Sets Panel"](#), on page 494).



Background information

Refer to [Chapter 9.6.2.5, "Port Pair De-/Embedding"](#), on page 276 and [Chapter 9.6.2.6, "Port Set De-/Embedding"](#), on page 276.

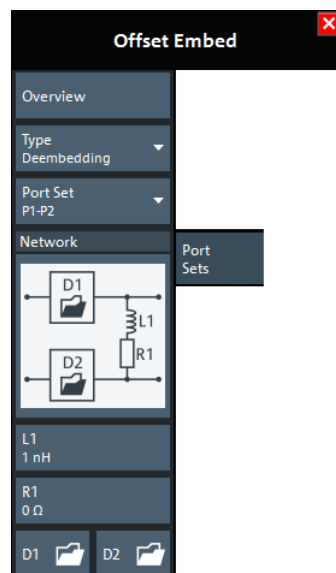

If the "Fixture Simulator" is disabled for the related channel (see ["Fixture Simulator"](#) on page 485), this tab is inactive, i.e. all controls except the "Overview" button are grayed out.

Overview

See ["Overview"](#) on page 500.

Type

Switches between "Deembedding" and "Embedding" network definition.

Port Set

Port sets, defined in the complementary [Port Sets Panel](#) dock widget panel. The transformation networks are defined such that the physical analyzer test ports are connected to the left of the circuit; the DUT ports are on the right side. You can define independent transformation networks for all port sets.

The port set number, i.e. the number at the beginning of each "Port Set" item, corresponds to the position of the port set in the [Port Sets Panel](#).

Remote command:

The port set number corresponds to the <ListId> numeric suffix in the port set de-/embedding commands; see e.g. `CALCulate<Ch>:TRANSform:VNETworks:PPAir:DEEMbedding<ListId>[:STATe]`.

All Deembedding Activated

Deactivates or activates all deembeddings (single-ended, balanced, port set, ground loop) for the active channel, if any.

This control is only visible if **Type** = "Deembedding".

Network

The 4-port deembedding/embedding network can either be defined via lumped element models (in combination with `s2p` Touchstone files) or via an `s4p` Touchstone file (see [Chapter 9.6.2.5, "Port Pair De-/Embedding"](#), on page 276). For networks (partly) defined by lumped elements, the lumped element parameters are displayed below the graphical network list. See [Chapter 9.6.2.4, "Circuit Models for 4-Port Networks"](#), on page 274.

The symbol selects "no network" and disables de-/embedding for the selected port set. The "D1" and "D2" networks are defined by imported S-parameter data; see [D1](#), [D2](#).

Tip:

- Drag and drop the network symbols in horizontal or vertical direction to switch to the next symbol. The lumped elements and S-parameter networks ("D1", "D2") are numbered from top to bottom.
- Use the [Conductance in Embedding Networks](#) switch to change from resistances in "Capacitor in parallel with resistor" circuit blocks to conductances and vice versa.

Remote command:

```
CALCulate<Ch>:TRANSform:VNETworks:PPAir:DEEMbedding<ListId>:
TNDefinition
CALCulate<Ch>:TRANSform:VNETworks:PPAir:DEEMbedding<ListId>:
PARAmeters:C<1|2|3>
CALCulate<Ch>:TRANSform:VNETworks:PPAir:DEEMbedding<ListId>:
PARAmeters:L<1|2|3>
CALCulate<Ch>:TRANSform:VNETworks:PPAir:DEEMbedding<ListId>:
PARAmeters:R<1|2|3>
CALCulate<Ch>:TRANSform:VNETworks:PPAir:DEEMbedding<ListId>:
PARAmeters:G<1|2|3>
CALCulate<Ch>:TRANSform:VNETworks:PPAir:EMBedding<ListId>:
TNDefinition
```

```

CALCulate<Ch>:TRANSform:VNETworks:PPAir:EMBedding<ListId>:
PARAmeters:C<1|2|3>
CALCulate<Ch>:TRANSform:VNETworks:PPAir:EMBedding<ListId>:
PARAmeters:L<1|2|3>
CALCulate<Ch>:TRANSform:VNETworks:PPAir:EMBedding<ListId>:
PARAmeters:R<1|2|3>
CALCulate<Ch>:TRANSform:VNETworks:PPAir:EMBedding<ListId>:
PARAmeters:G<1|2|3>

```

D1, D2

The "D1" (and "D2") buttons are enabled as long as the selected deembedding/embedding network is defined using Touchstone files.

When loading a touchstone file, the analyzer by default assumes odd ports left (VNA side), even ports right (DUT side). However, it is also possible to instruct the analyzer to assume an "Increasing Port Sequence", i.e. that the low port numbers are on the VNA side. Furthermore it is possible to "Swap Gates", i.e. to instruct the analyzer to swap the VNA and DUT side.

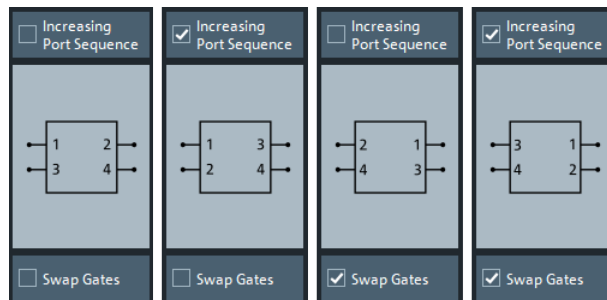

Note: The loaded file is stored in the active channel setup. Persisted channel setups contain the full de-/embedding data so that they can be transferred to other instruments.

Remote command:

```
MMEMory:LOAD:VNETworks<Ch>:PPAir:DEEMbedding<ListId>
```

```
MMEMory:LOAD:VNETworks<Ch>:PPAir:EMBedding<ListId>
```

10.14.6 Balanced Tab

Selects 4-port transformation networks for balanced port deembedding/embedding, defines their parameters, assigns them to a balanced port and enables embedding.

Use the complementary dock widget to create [Balanced Panel](#) and to activate or deactivate dembedding/embedding for selected balanced ports (see [Chapter 10.14.1.5, "Balanced Panel"](#), on page 496).



Background information

Refer to the section [Chapter 9.6.2.9, "Combining Several De-/Embedding Networks"](#), on page 279.

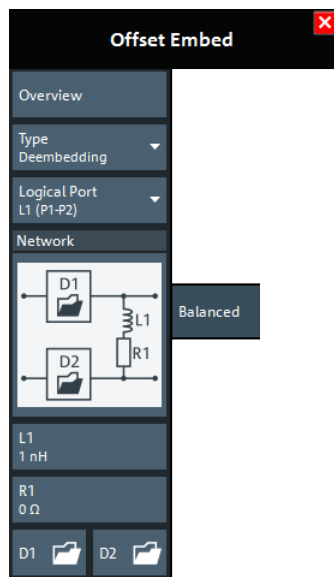

If the "Fixture Simulator" is disabled for the related channel (see ["Fixture Simulator"](#) on page 485), this tab is inactive, i.e. all controls except the "Overview" button are grayed out.

Overview

See ["Overview"](#) on page 500.

Type

Switches between "Deembedding" and "Embedding" network definition.

Logical Port

Logical analyzer port, as defined in the "Balanced Ports" configuration. The transformation networks are defined such that the physical analyzer test ports are connected to the left of the circuit; the DUT ports are on the right side.

Remote command:

The <LogPt> numeric suffix in the embedding/deembedding commands identifies the logical port; see e.g. `CALCulate<Ch>:TRANSform:VNETworks:BALanced:EMBedding<LogPt>[:STATe]`.

All Deembedding Activated

Deactivates or activates all deembeddings (single-ended, balanced, port set, ground loop) for the active channel, if any.

This control is only visible if **Type** = "Deembedding".

Remote command:

n.a.

Network

The graphical list contains all available 4-port networks (see [Chapter 9.6.2.4, "Circuit Models for 4-Port Networks"](#), on page 274).

The  symbol selects "no network" and disables deembedding/embedding for the selected balanced port.

Other 2-port data-subnetworks (symbols "D1" and "D2") are defined by means of s2p files (see [Network](#)).

The parameters of lumped elements are displayed below the graphical list.

Tip:

- Drag and drop the network symbols in horizontal or vertical direction to switch to the next symbol. The lumped elements and S-parameter networks ("D1", "D2") are numbered from top to bottom.
- Use the [Conductance in Embedding Networks](#) switch to change from resistances in "Capacitor in parallel with resistor" circuit blocks to conductances and vice versa.

Remote command:

```
CALCulate<Ch>:TRANSform:VNETworks:BALanced:DEEMbedding<LogPt>:
TNDefinition
```

```
CALCulate<Ch>:TRANSform:VNETworks:BALanced:DEEMbedding<LogPt>:
PARAMeters:C<Cmp>
```

```
CALCulate<Ch>:TRANSform:VNETworks:BALanced:DEEMbedding<LogPt>:
PARAMeters:L<Cmp>
```

```
CALCulate<Ch>:TRANSform:VNETworks:BALanced:DEEMbedding<LogPt>:
PARAMeters:R<Cmp>
```

```
CALCulate<Ch>:TRANSform:VNETworks:BALanced:DEEMbedding<LogPt>:
PARAMeters:G<Cmp>
```

```
CALCulate<Ch>:TRANSform:VNETworks:BALanced:EMBedding<LogPt>:
TNDefinition
```

```
CALCulate<Ch>:TRANSform:VNETworks:BALanced:EMBedding<LogPt>:
PARAMeters:C<Cmp>
```

```
CALCulate<Ch>:TRANSform:VNETworks:BALanced:EMBedding<LogPt>:
PARAMeters:L<Cmp>
```

```
CALCulate<Ch>:TRANSform:VNETworks:BALanced:EMBedding<LogPt>:
PARAMeters:R<Cmp>
```

```
CALCulate<Ch>:TRANSform:VNETworks:BALanced:EMBedding<LogPt>:
PARAMeters:G<Cmp>
```

D1, D2

The "D1" and "D2" buttons are enabled as long as the selected [Network](#) comprises subnetworks that are defined via two-port or four-port Touchstone files (*.s2p, *.s4p).

When loading a touchstone file, the analyzer by default assumes odd ports left (VNA side), even ports right (DUT side). However, it is also possible to instruct the analyzer to assume an "Increasing Port Sequence", i.e. that the low port numbers are on the VNA side. Furthermore it is possible to "Swap Gates", i.e. to instruct the analyzer to swap the VNA and DUT side.

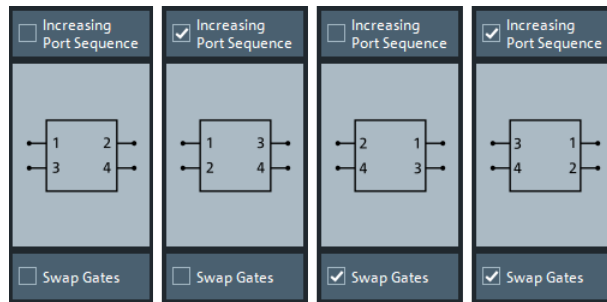

Note: The loaded file is stored in the active channel setup. Persisted channel setups contain the full (de-)embedding data so that they can be transferred to other instruments.

Remote command:

`MMEMory:LOAD:VNETworks<Ch>:BALanced:DEEMbedding<LogPt>`

`MMEMory:LOAD:VNETworks<Ch>:BALanced:EMBedding<LogPt>`

10.14.7 Ground Loop Tab

Allows you to specify a 1-port ground loop deembedding/embedding network.

Such a network is either defined

- via its S-parameter stored in a one-port Touchstone file (*.s1p) or
- by selecting a predefined lumped element model (Shunt L or Shunt C) and specifying the available parameters (resistance/inductance or resistance/capacitance)

Use the complementary dock widget to activate or deactivate ground loop deembedding and embedding (see [Chapter 10.14.1.6, "Ground Loop Panel"](#), on page 497).



Background information

Refer to [Chapter 9.6.2.7, "Ground Loop De-/Embedding"](#), on page 278.

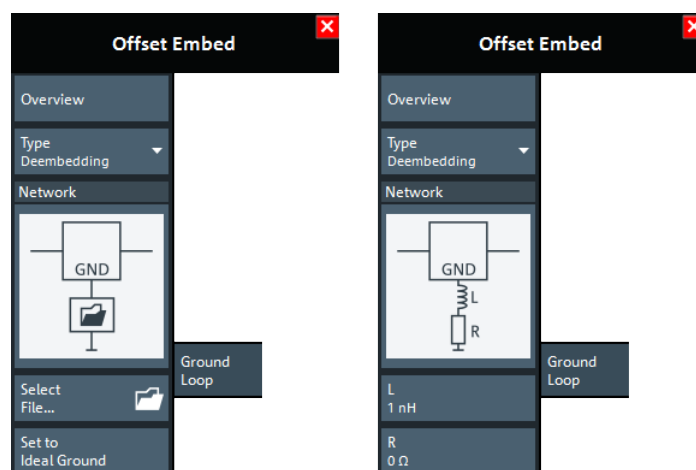



If the "Fixture Simulator" is disabled for the related channel (see ["Fixture Simulator"](#) on page 485), this tab is inactive, i.e. all controls except the "Overview" button are grayed out.

Overview

See ["Overview"](#) on page 500.

Type

Switches between "Deembedding" and "Embedding" network definition.

All Deembedding Activated

Deactivates or activates all deembeddings (single-ended, balanced, port set, ground loop) for the active channel, if any.

This control is only visible if **Type** = "Deembedding".

Network

The graphical list contains all available 1-port networks:

The symbol selects "no network" and disables ground loop de-/embedding.

The "1-Port Data" network is defined by imported S-parameter data; see [Select File...](#)

The remaining networks (Shunt L and Shunt C) are defined by lumped elements whose parameters are displayed below the graphical list.

Tip:

- Drag and drop the network symbols in horizontal or vertical direction to switch to the next symbol.
- Use the [Conductance in Embedding Networks](#) switch to change from resistances in "Capacitor in parallel with resistor" model to conductances and vice versa.

Remote command:

```
CALCulate<Ch>:TRANSform:VNETworks:GLOop:DEEMbedding:TNDefinition
CALCulate<Ch>:TRANSform:VNETworks:GLOop:DEEMbedding:PARAmeters:C
CALCulate<Ch>:TRANSform:VNETworks:GLOop:DEEMbedding:PARAmeters:L
CALCulate<Ch>:TRANSform:VNETworks:GLOop:DEEMbedding:PARAmeters:R
CALCulate<Ch>:TRANSform:VNETworks:GLOop:DEEMbedding:PARAmeters:G
CALCulate<Ch>:TRANSform:VNETworks:GLOop:EMBedding:TNDefinition
CALCulate<Ch>:TRANSform:VNETworks:GLOop:EMBedding:PARAmeters:C
CALCulate<Ch>:TRANSform:VNETworks:GLOop:EMBedding:PARAmeters:L
CALCulate<Ch>:TRANSform:VNETworks:GLOop:EMBedding:PARAmeters:R
CALCulate<Ch>:TRANSform:VNETworks:GLOop:EMBedding:PARAmeters:G
```

Select File...

"Select File..." is enabled as long as the "1-Port Data" network is selected. This network is defined by its S-parameters stored in a one-port Touchstone file (*.s1p). No additional parameters are required.

Note: The loaded file is stored in the active channel setup. Persisted channel setups contain the full (de-)embedding data so that they can be transferred to other instruments.

Remote command:

`MMEMory:LOAD:VNETworks<Ch>:GLOop:DEEMbedding`

`MMEMory:LOAD:VNETworks<Ch>:GLOop:EMBedding`

Set to Ideal Ground

This function is enabled as long as the 1-Port Data network is active. An imported S-parameter set is replaced by the S-parameters of an ideal through connection, which eliminates the transformation network.

10.14.8 Differential Match Tab

Allows you to specify a 2-port embedding network for the differential mode of a balanced port.

Such a network is either defined

- via its S-parameter stored in a two-port Touchstone file (*.s2p) or
- by specifying the parameters of a "Shunt L, Shunt C" lumped element model

Use the complementary dock widget to access the balanced port configuration and to activate or deactivate "Differential Match" embedding for selected balanced ports (see [Chapter 10.14.1.8, "Differential Match Panel"](#), on page 498).



Background information

Refer to [Chapter 9.6.2.8, "Differential Match Embedding"](#), on page 278.

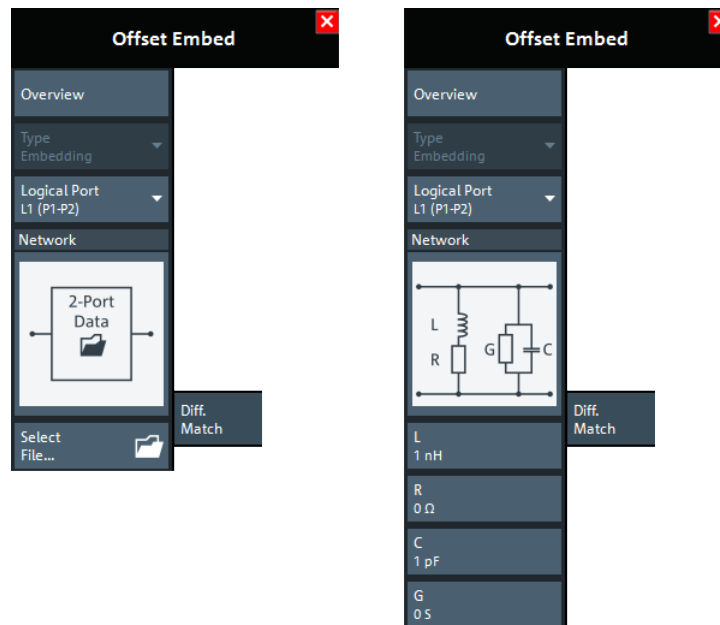

If the "Fixture Simulator" is disabled for the related channel (see ["Fixture Simulator"](#) on page 485), this tab is inactive, i.e. all controls except the "Overview" button are grayed out.

Overview

See ["Overview"](#) on page 500.

Type

Currently only Differential Match"Embedding" is supported.

Logical Port

Logical analyzer port, as defined in the "Balanced Ports" configuration. The transformation networks are defined such that the physical analyzer test ports are connected to the left of the circuit; the DUT ports are on the right side. You can define independent embedding networks for all balanced ports.

Remote command:

The <LogPt> numeric suffix in the embedding/deembedding commands identifies the logical port; see e.g. `CALCulate<Ch>:TRANSform:VNETworks:DIFFerential:EMBedding<LogPt>[:STATe]`.

Network

The graphical list contains the available 2-port networks for Differential Match embedding:

- The symbol selects "no network" and disables differential match embedding for the selected balanced port.
- The "2-Port Data" network is defined by means of imported S-parameter data; see [Select File...](#)
- The "Shunt L, Shunt C" network is defined by lumped elements whose parameters are displayed below the graphical list.

Tip: Drag and drop the network symbols in horizontal or vertical direction to switch to the next symbol.

Remote command:

```
CALCulate<Ch>:TRANSform:VNETworks:DIFFerential:EMBedding<LogPt>:
TNDefinition
```

```
CALCulate<Ch>:TRANSform:VNETworks:DIFFerential:EMBedding<LogPt>:
PARAMeters:L<Cmp>
```

```
CALCulate<Ch>:TRANSform:VNETworks:DIFFerential:EMBedding<LogPt>:
PARAMeters:R<Cmp>
```

```
CALCulate<Ch>:TRANSform:VNETworks:DIFFerential:EMBedding<LogPt>:
PARAMeters:C<Cmp>
```

```
CALCulate<Ch>:TRANSform:VNETworks:DIFFerential:EMBedding<LogPt>:
PARAMeters:G<Cmp>
```

Select File...

"Select File..." is enabled as long as the "2-Port Data" network is selected. This network is defined by its S-parameters stored in a two-port Touchstone file (*.s2p). No additional parameters are required.

Note: The loaded file is stored in the active channel setup. Persisted channel setups contain the full (de-)embedding data so that they can be transferred to other instruments.

Remote command:

```
MMEMory:LOAD:VNETworks<Ch>:DIFFerential:EMBedding<LogPt>
```

10.14.9 Config Tab

The "Config" tab provides means to configure the overall "Offset Embed" calculation.

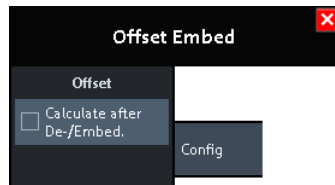

Offset > Calculate after De-/Embed.

Changes the position of the "Offset" calculation in the "Offset Embed" calculation chain.

If unchecked (default), the offset is calculated before de-/embedding. If checked, it is calculated after de-/embedding.

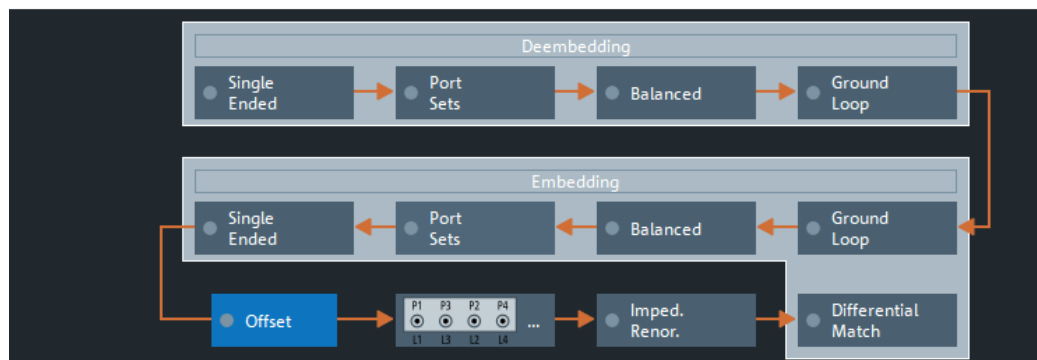
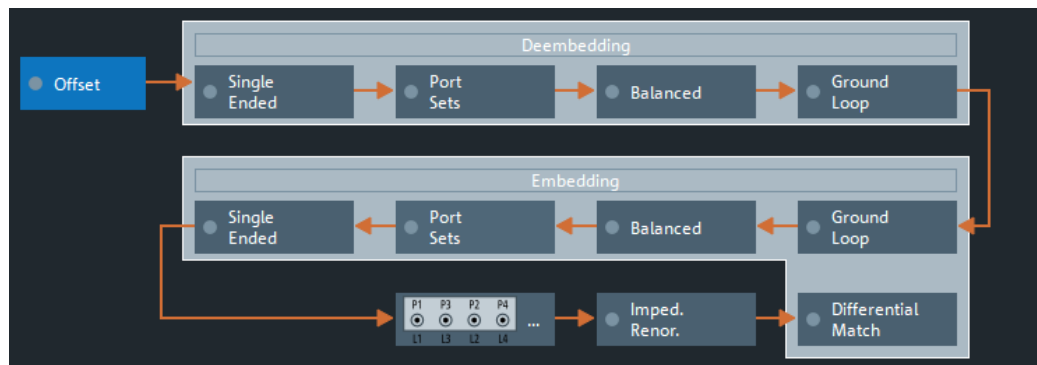

Top = Default offset calculation

Bottom = Offset calculation after de-/embedding (GUI mockup)

Remote command:

`[SENSE:]CORrection:EDELay:VNETwork`

11 Command Reference

The commands required to perform measurements in the VNA and Spectrum applications in a remote environment are described here.

It is assumed that the R&S ZNL/ZNLE has already been set up for remote operation in a network as described in [Chapter 8.5, "How to Set Up a Network and Remote Control"](#), on page 166.

• Conventions Used in SCPI Command Descriptions	520
• Common Commands	521
• Common Instrument Commands	525
• VNA Remote Control Basics	576
• VNA Command Reference	595
• VNA Programming Examples	957
• List of commands	987

11.1 Conventions Used in SCPI Command Descriptions

Note the following conventions used in the remote command descriptions:

- **Command usage**
If not specified otherwise, commands can be used both for setting and for querying parameters.
If a command can be used for setting or querying only, or if it initiates an event, the usage is stated explicitly.
- **Parameter usage**
If not specified otherwise, a parameter can be used to set a value and it is the result of a query.
Parameters required only for setting are indicated as **Setting parameters**.
Parameters required only to refine a query are indicated as **Query parameters**.
Parameters that are only returned as the result of a query are indicated as **Return values**.
- **Conformity**
Commands that are taken from the SCPI standard are indicated as **SCPI confirmed**. All commands used by the R&S ZNL/ZNLE follow the SCPI syntax rules.
- **Asynchronous commands**
A command which does not automatically finish executing before the next command starts executing (overlapping command) is indicated as an **Asynchronous command**.
- **Reset values (*RST)**
Default parameter values that are used directly after resetting the instrument (*RST command) are indicated as ***RST** values, if available.
- **Default unit**
The default unit is used for numeric values if no other unit is provided with the parameter.

11.2 Common Commands

Common commands are described in the IEEE 488.2 (IEC 625-2) standard. These commands have the same effect and are employed in the same way on different devices. The headers of these commands consist of "*" followed by three letters. Many common commands are related to the Status Reporting System.

Available common commands:

*CAL?	521
*CLS	521
*ESE	521
*ESR?	522
*IDN?	522
*IST?	522
*OPC	522
*OPT?	522
*PCB	523
*PRE	523
*PSC	523
*RST	523
*SRE	524
*STB?	524
*TRG	524
*TST?	524
*WAI	524

*CAL?

Usage: Query only

*CLS

Clear status

Sets the status byte (STB), the standard event register (ESR) and the `EVENT` part of the `QUESTIONABLE` and the `OPERATION` registers to zero. The command does not alter the mask and transition parts of the registers. It clears the output buffer.

Usage: Setting only

*ESE <Value>

Event status enable

Sets the event status enable register to the specified value. The query returns the contents of the event status enable register in decimal form.

Parameters:

<Value> Range: 0 to 255

***ESR?**

Event status read

Returns the contents of the event status register in decimal form and then sets the register to zero.

Return values:

<Contents> Range: 0 to 255

Usage: Query only

***IDN?**

Identification

Returns the instrument identification.

Example: Rohde&Schwarz,ZVA8-4Port,12345,0.10.1.23

Example: Rohde-Schwarz,ZNL3-2Port,
1323.0012K03/123456,1.22

Usage: Query only

***IST?**

Individual status query

Returns the contents of the IST flag in decimal form. The IST flag is the status bit which is sent during a parallel poll.

Return values:

<ISTflag> 0 | 1

Usage: Query only

***OPC**

Operation complete

Sets bit 0 in the event status register when all preceding commands have been executed. This bit can be used to initiate a service request. The query writes a "1" into the output buffer when all preceding commands have been executed, which is useful for command synchronization.

***OPT?**

Option identification query

Queries the options included in the instrument. For a list of all available options and their description, refer to the data sheet.

Return values:

<Options>

The query returns a list of options. The options are returned at fixed positions in a comma-separated string. A zero is returned for options that are not installed.

Usage:

Query only

***PCB <Address>**

Pass control back

Indicates the controller address to which remote control is returned after termination of the triggered action.

Setting parameters:

<Address>

Range: 0 to 30

Usage:

Setting only

***PRE <Value>**

Parallel poll register enable

Sets parallel poll enable register to the indicated value. The query returns the contents of the parallel poll enable register in decimal form.

Parameters:

<Value>

Range: 0 to 255

***PSC <Action>**

Power on status clear

Determines whether the contents of the `ENABLE` registers are preserved or reset when the instrument is switched on. Thus a service request can be triggered when the instrument is switched on, if the status registers ESE and SRE are suitably configured. The query reads out the contents of the "power-on-status-clear" flag.

Parameters:

<Action>

0 | 1

0

The contents of the status registers are preserved.

1

Resets the status registers.

***RST**

Reset

Sets the instrument to a defined default status. The default settings are indicated in the description of commands.

Usage: Setting only

***SRE** <Contents>

Service request enable

Sets the service request enable register to the indicated value. This command determines under which conditions a service request is triggered.

Parameters:

<Contents> Contents of the service request enable register in decimal form. Bit 6 (MSS mask bit) is always 0.
Range: 0 to 255

***STB?**

Status byte query

Reads the contents of the status byte in decimal form.

Usage: Query only

***TRG**

Trigger

Triggers all actions waiting for a trigger event. In particular, *TRG generates a manual trigger signal. This common command complements the commands of the TRIGger subsystem.

*TRG corresponds to the INITiate:IMMediate command (see INITiate<Ch>[:IMMediate][:DUMMy] on page 780).

Usage: Event

***TST?**

Self-test query

Initiates self-tests of the instrument and returns an error code.

Return values:

<ErrorCode> **integer > 0 (in decimal format)**
An error occurred.
0
No errors occurred.

Usage: Query only

***WAI**

Wait to continue

Prevents servicing of the subsequent commands until all preceding commands have been executed and all signals have settled (see also command synchronization and *OPC).

Usage: Event

Manual operation: See "Remote Settings: Wait for Data after Sweep" on page 146

11.3 Common Instrument Commands

The following commands can be used independently of the active application(s).

- [Commands for Remote Instrument Operation](#)..... 525
- [Selecting the Operating Mode and Application](#)..... 526
- [Managing Settings and Results](#)..... 533
- [Configuring the R&S ZNL/ZNLE](#)..... 558

11.3.1 Commands for Remote Instrument Operation

The following commands are required to shutdown or reboot the R&S ZNL/ZNLE from a remote PC.

SYSTem:CLOGging	525
SYSTem:REBoot	525
SYSTem:SHUTdown	526

SYSTem:CLOGging <State>

This command turns logging of remote commands on and off.

Parameters:

<State> ON | OFF | 1 | 0

ON | 1
Writes all remote commands that have been sent to a file.
The destination is C:
 \ProgramData\Rohde-Schwarz\ZNL-FPL\ScpiLogging\
 ScpiLog.<no.>.
 where <no.> is a sequential number
 A new log file is started each time logging was stopped and is restarted.

OFF | 0
*RST: 0

Manual operation: See "I/O Logging" on page 160

SYSTem:REBoot

This command reboots the instrument, including the operating system.

SYSTem:SHUTdown

This command shuts down the instrument.

11.3.2 Selecting the Operating Mode and Application

The following commands are required to select the operating mode or the application and to configure a Sequencer in a remote environment.

- [Selecting the Mode and Applications](#)..... 526
- [Performing a Sequence of Measurements](#)..... 529
- [Programming Example: Performing a Sequence of Measurements](#)..... 531

11.3.2.1 Selecting the Mode and Applications

DISPlay:ATAB	526
INSTrument:CREate:DUPLicate	526
INSTrument:CREate[:NEW]	527
INSTrument:CREate:REPLace	527
INSTrument:DELeTe	527
INSTrument:LIST?	528
INSTrument:REName	528
INSTrument[:SELeCt]	529

DISPlay:ATAB <State>

This command switches between the MultiView tab and the most recently displayed channel setup. If only one channel setup is active, this command has no effect.

Parameters:

<State>	ON OFF 0 1
	OFF 0
	Switches the function off
	ON 1
	Switches the function on

INSTrument:CREate:DUPLicate

This command duplicates the currently selected channel setup, i.e. creates a new channel setup of the same type and with the identical measurement settings. The name of the new channel setup is the same as the copied channel setup, extended by a consecutive number (e.g. "IQAnalyzer" -> "IQAnalyzer 2").

The channel setup to be duplicated must be selected first using the `INST:SEL` command.

Usage: Event

Manual operation: See "[Duplicate Current Channel Setup](#)" on page 90

INSTrument:CREate[:NEW] <ChannelType>, <ChannelName>

This command adds an additional measurement channel. You can configure up to 10 measurement channels at the same time (depending on available memory).

See also

- [INSTrument\[:SElect\]](#) on page 529
- [INSTrument:DELeTe](#) on page 527

Parameters:

<ChannelType>	Channel type of the new channel. For a list of available channel types see INSTrument:LIST? on page 528.
<ChannelName>	String containing the name of the channel. Note that you can not assign an existing channel name to a new channel; this will cause an error.

Example: `INST:CRE SAN, 'Spectrum 2'`
Adds an additional spectrum display named "Spectrum 2".

Manual operation: See "[New Channel Setup](#)" on page 89

INSTrument:CREate:REPLace <ChannelName1>,<ChannelType>,<ChannelName2>

This command replaces a channel setup with another one.

Setting parameters:

<ChannelName1>	String containing the name of the channel setup you want to replace.
<ChannelType>	Channel type of the new channel setup. For a list of available channel setup types see INSTrument:LIST? on page 528.
<ChannelName2>	String containing the name of the new channel setup. Note: If the specified name for a new channel setup already exists, the default name, extended by a sequential number, is used for the new channel setup (see INSTrument:LIST? on page 528). Channel names can have a maximum of 31 characters, and must be compatible with the Windows conventions for file names. In particular, they must not contain special characters such as ":", "*", "?".

Usage: Setting only

Manual operation: See "[Replace Current Channel Setup](#)" on page 90

INSTrument:DELeTe <ChannelName>

This command deletes a channel setup.

Setting parameters:

<ChannelName> String containing the name of the channel setup you want to delete.
A channel setup must exist in order to be able delete it.

Usage: Setting only

Manual operation: See "[Closing a channel setup](#)" on page 90

INSTrument:LIST?

This command queries all active channel setups. This is useful in order to obtain the names of the existing channel setups, which are required in order to replace or delete the channel setups.

Return values:

<ChannelType>, For each channel setup, the command returns the channel setup type and channel setup name (see tables below).
<ChannelName>

Tip: to change the channel setup name, use the [INSTrument:REName](#) command.

Example:

INST:LIST?

Result for 3 channel setups:

```
'ADEM', 'Analog Demod', 'IQ', 'IQ Analyzer', 'IQ', 'IQ Analyzer2'
```

Usage: Query only

Manual operation: See "[Defining a channel setup](#)" on page 89

Table 11-1: Available channel setup types and default channel setup names

Application	<ChannelType> Parameter	Default Channel Setup Name*)
Spectrum	SANALYZER	Spectrum
AM/FM/PM Modulation Analysis	ADEM	Analog Demod
I/Q Analyzer	IQ	IQ Analyzer
Noise Figure Measurements	NOISE	Noise
Vector Signal Analysis (VSA)	DDEM	VSA
Network analysis	Vna	VNA

Note: the default channel setup name is also listed in the table. If the specified name for a new channel setup already exists, the default name, extended by a sequential number, is used for the new channel setup.

INSTrument:REName <ChannelName1>, <ChannelName2>

This command renames a channel setup.

Setting parameters:

- <ChannelName1> String containing the name of the channel setup you want to rename.
- <ChannelName2> String containing the new channel setup name.
Note that you cannot assign an existing channel setup name to a new channel setup; this will cause an error.
Channel names can have a maximum of 31 characters, and must be compatible with the Windows conventions for file names. In particular, they must not contain special characters such as ":", "*", "?".

Usage: Setting only

INSTrument[:SElect] <ChannelType> | <ChannelName>

This command activates a new channel setup with the defined channel setup type, or selects an existing channel setup with the specified name.

Also see

- [INSTrument:CREate\[:NEW\]](#) on page 527

Parameters:

- <ChannelType> Channel type of the new channel setup.
For a list of available channel setup types see [INSTrument:LIST?](#) on page 528.
- <ChannelName> String containing the name of the channel setup.

Example:

```
INST IQ
INST 'MyIQSpectrum'
```

Selects the channel setup named 'MyIQSpectrum' (for example before executing further commands for that channel setup).

Manual operation: See "[VNA](#)" on page 86

11.3.2.2 Performing a Sequence of Measurements

The following commands control the sequencer.

For details on the Sequencer see [Chapter 5.4, "Running a Sequence of Measurements"](#), on page 90.

INITiate:SEQuencer:ABORt	529
INITiate:SEQuencer:IMMediate	530
INITiate:SEQuencer:MODE	530
SYSTem:SEQuencer	531

INITiate:SEQuencer:ABORt

This command stops the currently active sequence of measurements.

You can start a new sequence any time using `INITiate:SEQuencer:IMMediate` on page 530.

Usage: Event

Manual operation: See " [Sequencer State](#) " on page 93

INITiate:SEQuencer:IMMediate

This command starts a new sequence of measurements by the Sequencer.

Before this command can be executed, the Sequencer must be activated (see `SYSTem:SEQuencer` on page 531).

Example:

```
SYST:SEQ ON
  Activates the Sequencer.
INIT:SEQ:MODE SING
  Sets single sequence mode so each active measurement will be
  performed once.
INIT:SEQ:IMM
  Starts the sequential measurements.
```

Manual operation: See " [Sequencer State](#) " on page 93

INITiate:SEQuencer:MODE <Mode>

Defines the capture mode for the entire measurement sequence and all measurement groups and channels it contains.

Note: In order to synchronize to the end of a measurement sequence using `*OPC`, `*OPC?` or `*WAI` you must use `SINGle` Sequence mode.

Parameters:

<Mode>

SINGle

Each measurement group is started one after the other in the order of definition. All measurement channels in a group are started simultaneously and performed once. After *all* measurements are completed, the next group is started. After the last group, the measurement sequence is finished.

CONTInuous

Each measurement group is started one after the other in the order of definition. All measurement channels in a group are started simultaneously and performed once. After *all* measurements are completed, the next group is started. After the last group, the measurement sequence restarts with the first one and continues until it is stopped explicitly.

```
*RST: CONTInuous
```

Manual operation: See " [Sequencer Mode](#) " on page 93

SYSTem:SEQuencer <State>

This command turns the Sequencer on and off. The Sequencer must be active before any other Sequencer commands (INIT:SEQ...) are executed, otherwise an error will occur.

Parameters:

<State> ON | OFF | 0 | 1

ON | 1

The Sequencer is activated and a sequential measurement is started immediately.

OFF | 0

The Sequencer is deactivated. Any running sequential measurements are stopped. Further Sequencer commands (INIT:SEQ...) are not available.

*RST: 0

Example:

SYST:SEQ ON

Activates the Sequencer.

INIT:SEQ:MODE SING

Sets single Sequencer mode so each active measurement will be performed once.

INIT:SEQ:IMM

Starts the sequential measurements.

SYST:SEQ OFF

Manual operation: See " [Sequencer State](#) " on page 93

11.3.2.3 Programming Example: Performing a Sequence of Measurements

This example demonstrates how to perform several measurements in a sequence in a remote environment.

```
//2xSpectrumAnalyzer + 2xIQ, start Sequencer at the end, test OPC?
// -----

//-----Preparing the instrument and first channel -----
*RST
//Activate new IQ channel
INSTrument:CREate:NEW IQ,'IQ 1'
//Set sweep count for new IQ channel
SENS:SWEEP:COUNT 6
//Change trace modes for IQ channel
DISP:TRAC1:MODE BLANK
DISP:TRAC2:MODE MAXH
DISP:TRAC3:MODE MINH
//Switch to single sweep mode
INIT:CONT OFF
//switch back to first (default) analyzer channel
```

```

INST:SEL 'Spectrum';*WAI
//Switch into SEM
SENSE:SWEep:MODE ESpectrum
//Load Sem standard file for W-CDMA
SENSE:ESpectrum:PRESet:STANdard 'WCDMA\3GPP\DL\3GPP_DL.xml'
//Set sweep count in Spectrum channel
SENS:SWEEP:COUNT 5

//-----Creating a second measurement channel -----

//Create second IQ channel
INSTrument:CREate:NEW IQ,'IQ 2'
//Set sweep count
SENS:SWEEP:COUNT 2
//Change trace modes
DISP:TRAC1:MODE MAXH
DISP:TRAC2:MODE MINH
//Create new analyzer channel
INSTrument:CREate:NEW SANalyzer,'Spectrum 2'
//Activate ACLR measurement in channel 'Spectrum 2'
CALCulate:MARKer:FUNCTion:POWer:SElect ACPower
//Load W-CDMA Standard
CALCulate:MARKer:FUNCTion:POWer:PRESet FW3Gppcdma
//Change trace modes
DISP:TRAC2:MODE MAXH
DISP:TRAC1:MODE MINH

//-----Performing a sweep and retrieving results-----

//Change sweep count
SENS:SWEEP:COUNT 7
//Single Sweep mode
INIT:CONT OFF
//Switch back to first IQ channel
INST:SEL 'IQ 1';*WAI
//Perform a measurement
INIT:IMM;*OPC?
//Retrieve results
CALC:MARK:Y?
//Activate Multiview
DISPlay:ATAB ON

//-----Performing a sequence of measurements with the Sequencer-----
//Activate Sequencer
SYSTem:SEQuencer ON
//Start sweep in Sequencer
INITiate:SEQuencer:IMMediate;*OPC?
//Switch into first IQ channel to get results
INST:SEL 'IQ 1';*WAI
CALCulate:MARKer:MAXimum

```

```

CALC:MARK:Y?
//Change sweep time in IQ
SENS:SWE:TIME 300us
//Switch to single Sequencer mode
INITiate:SEQuencer:MODE SINGLE
//Sweep all channels once, taking the sweep count in each channel into account
INITiate:SEQuencer:IMMediate;*OPC?
//Set marker to maximum in IQ1 and query result
CALCulate:MARKer:MAXimum
CALC:MARK:Y?
//Switch to second IQ channel and retrieve results
INST:SEL 'IQ 2';*WAI
CALCulate:MARKer:MIN
CALC:MARK:Y?
//Switch to first Spectrum channel
INST:SEL 'Spectrum';*WAI
//Query one of the SEM results
CALCulate:MARKer:FUNCTion:POWer:RESult? CPOWer
//Switch to second Spectrum channel
INST:SEL 'Spectrum 2';*WAI
//Query channel power result
CALCulate:MARKer:FUNCTion:POWer:RESult? ACPoWer

```

11.3.3 Managing Settings and Results

The commands required to store and load instrument settings and import and export measurement results in a remote environment are described here.

Addressing drives

The various drives can be addressed via the "mass storage instrument specifier" <msis> using the conventional Windows syntax. The internal hard disk is addressed by "C:".

For details on storage locations refer to [Chapter 6.2.2.2, "Storage Location and File-name"](#), on page 100.

The file names (<FileName> parameter) are given as string parameters enclosed in quotation marks. They also comply with Windows conventions. Windows file names do not distinguish between uppercase and lowercase notation.

Wildcards

The two characters "*" and "?" can be used as "wildcards", i.e., they are variables for a selection of several files. The question mark "?" replaces exactly one character, the asterisk replaces any of the remaining characters in the file name. "*. *" thus means all files in a directory.

Path names

Storage locations can be specified either as absolute (including the entire path) or relative paths (including only subfolders of the current folder). Use the `MMEM:CDIR?` query to determine the current folder.

- [General Data Storage and Loading Commands](#)..... 534
- [Storing and Loading Instrument Settings](#)..... 539
- [Storing or Printing Screenshots](#)..... 544
- [Storing Measurement Results](#)..... 554
- [Examples: Managing Data](#)..... 554

11.3.3.1 General Data Storage and Loading Commands

The following commands are available for all applications.

FORMat:DEXPort:DSEPARATOR	534
MMEMory:CATalog	535
MMEMory:CATalog:LONG	535
MMEMory:CDIRectory	535
MMEMory:COMMeNt	535
MMEMory:COpy	536
MMEMory:DATA	536
MMEMory:DELeTe:IMMeDiate	537
MMEMory:MDIRectory	537
MMEMory:MOVe	537
MMEMory:MSIS	537
MMEMory:NAME	538
MMEMory:NETWork:DISConnect	538
MMEMory:NETWork:MAP	538
MMEMory:NETWork:UNUSeddrives	539
MMEMory:NETWork:USEDdrives	539
MMEMory:RDIRectory	539

FORMat:DEXPort:DSEPARATOR <Separator>

This command selects the decimal separator for data exported in ASCII format.

Parameters:

<Separator>	POINT COMMa
	COMMa
	Uses a comma as decimal separator, e.g. <i>4,05</i> .
	POINT
	Uses a point as decimal separator, e.g. <i>4.05</i> .
*RST:	*RST has no effect on the decimal separator.
	Default is POINT.

Example:

```
FORM:DEXP:DSEP POIN
Sets the decimal point as separator.
```

MMEMory:CATalog <FileName>

This command returns the contents of a particular directory.

Parameters:

<FileName> String containing the path and directory
 If you leave out the path, the command returns the contents of the directory selected with [MMEMory:CDIRectory](#) on page 535.
 The path may be relative or absolute. Using wildcards (*) is possible to query a certain type of files only.
 If you use a specific file as a parameter, the command returns the name of the file if the file is found in the specified directory, or an error if the file is not found ("-256, "File name not found").

Example:

```
MMEM:CAT? 'C:\Data\SPOOL?.PNG'
```

Returns all files in C:\Data\ whose names start with SPOOL, have 6 characters and the extension .PNG, e.g.:
 SPOOL1.PNG, SPOOL2.PNG, SPOOL3.PNG

Example:

```
MMEM:CAT? 'C:\Data\SPOOL6.PNG'
```

Query whether the file 'SPOOL6.PNG' also exists in the directory;

Result:

```
-256,"File name not found::MMEMory:CATalog?
```

```
'C:\Data\SPOOL6.PNG'
```

MMEMory:CATalog:LONG <Directory>

This command returns the contents of a particular directory with additional information about the files.

Parameters:

<Directory> String containing the path and directory.
 If you leave out the path, the command returns the contents of the directory selected with [MMEMory:CDIRectory](#) on page 535.
 The path may be relative or absolute. Using wildcards (*) is possible to query a certain type of files only.

MMEMory:CDIRectory <Directory>

This command changes the current directory.

Parameters:

<Directory> String containing the path to another directory.
 The path may be relative or absolute.

MMEMory:COMMeNt <Comment>

This command defines a comment for the stored settings.

Parameters:

<Comment> String containing the comment.

Example:

```
MMEMemory:COMMENT "ACP measurement with Standard Tetra from 23.05."
```

```
MMEMemory::MMEMemory:STORE1:STATE 1, "ACP_T"
```

As a result, in the selection list for recall settings, the comment "ACP measurement with Standard Tetra from 23.05." is added to the ACP entry.

Manual operation: See "[Comment](#)" on page 101

MMEMemory:COPY <FileName>, <FileName>

This command copies one or more files to another directory.

Parameters:

<FileName> String containing the path and file name of the source file.

<FileName> String containing the path and name of the target file.
The path may be relative or absolute.

MMEMemory:DATA <FileName>[, <Data>]**MMEMemory:DATA?** <FileName>

This command writes block data into a file. The delimiter must be set to EOI to obtain error-free data transfer.

When you query the contents of a file, you can save them in a file on the remote control computer.

The command is useful for reading stored settings files or trace data from the instrument or for transferring them to the instrument

Parameters:

<Data> <block_data>
Data block with the following structure.

Hash sign.
<number>
Length of the length information.
<number>
Length information of the binary data (number of bytes).
<data>
Binary data with the indicated <number> of bytes.

Parameters for setting and query:

<FileName>

Example: `MMEM:NAME '\Public\User\Testfile.txt'`
 Creates a new file called 'testfile.txt'.
`MMEM:DATA 'Testfile.txt',#220` Contents of the file
 file
 The parameter means:
 #2: hash sign and length of the length information (20 bytes = 2 digits)
 20: indicates the number of subsequent binary data bytes.
 Contents of the file: store 20 binary bytes (characters) to the file.
`MMEM:DATA? 'Testfile.txt'`
 Returns the contents of the file.

MMEMory:DELeTe:IMMediate <FileName>

This command deletes a file.

Parameters:

<FileName> String containing the path and file name of the file to delete.
 The path may be relative or absolute.

MMEMory:MDIRectory <Directory>

This command creates a new directory.

Parameters:

<Directory> String containing the path and new directory name
 The path may be relative or absolute.

MMEMory:MOVE <FileName>, <FileName>

This command moves a file to another directory.

The command also renames the file if you define a new name in the target directory.

If you do not include a path for <NewFileName>, the command just renames the file.

Parameters:

<FileName> String containing the path and file name of the source file.

<FileName> String containing the path and name of the target file.

Example:

`MMEM:MOVE 'C:\TEST01.CFG', 'SETUP.CFG'`
 Renames TEST01.CFG in SETUP.CFG in directory C:\.

MMEMory:MSIS <Drive>

This command selects the default storage device used by all MMEMory commands.

Parameters:

<Drive> 'A:' | 'C:' | ... | 'Z:'

String containing the device drive name

*RST: n.a.

MMEMory:NAME <FileName>

This command has several purposes, depending on the context it is used in.

- It creates a new and empty file.
- It defines the file name for screenshots taken with `HCOPY[:IMMEDIATE<1|2>]`.
Note that you have to route the printer output to a file.

Parameters:

<FileName> String containing the path and name of the target file.

Example:

```
MMEM:NAME 'C:\Data\PRINT1.BMP'
```

Selects the file name.

MMEMory:NETWork:DISConnect <Drive>[, <State>]

This command disconnects a network drive.

Parameters:

<Drive> String containing the drive name.

<State> 1 | 0 | ON | OFF

Optional: determines whether disconnection is forced or not

1 | ON

Disconnection is forced.

0 | OFF

Disconnect only if not in use.

*RST: 0

MMEMory:NETWork:MAP <FilePath>, <IP>[, <UserName>, <Password>, <State>]

This command maps a drive to a server or server directory of the network.

Note that you have to allow sharing for a server or folder in Microsoft networks first.

Parameters:

<FilePath> String containing the drive name or path of the directory you want to map.

<IP> String containing the host name of the computer or the IP address and the share name of the drive.
'<host name or IP address\share name>'

<UserName> String containing a user name in the network.
The user name is optional.

<Password> String containing the password corresponding to the <UserName>.
The password is optional.

<State> ON | OFF | 1 | 0

ON | 1

Reconnects at logon with the same user name.

OFF | 0

Does not reconnect at logon.

MMEMory:NETWork:UNUSeddrives

This command returns a list of unused network drives.

MMEMory:NETWork:USEDdrives [<State>]

This command returns a list of all network drives in use.

Parameters:

<State>

You do not have to use the parameter. If you do not include the parameter, the command returns a list of all drives in use. This is the same behavior as if you were using the parameter OFF.

ON | 1

Returns a list of all drives in use including the folder information.

OFF | 0

Returns a list of all drives in use.

MMEMory:RDIRECTory <arg0>

This command deletes the indicated directory.

Parameters:

<arg0>

String containing the path of the directory to delete. Note that the directory you want to remove must be empty.

11.3.3.2 Storing and Loading Instrument Settings

See also:

- [INSTrument\[:SElect\]](#) on page 529 to select the channel setup.

MMEMory:CLEar:ALL	539
MMEMory:CLEar:STATe	540
MMEMory:LOAD:AUTO	540
MMEMory:LOAD:STATe	540
MMEMory:LOAD:TYPE	541
MMEMory:STORe<1 2>:STATe	542
MMEMory:STORe<1 2>:STATe:NEXT	542
MMEMory:STORe<1 2>:TYPE	543
SYSTem:PRESet	543
SYSTem:PRESet:CHANnel[:EXEC]	543

MMEMory:CLEar:ALL

This command deletes all instrument configuration files in the current directory.

You can select the directory with [MMEMory:CDIRectory](#) on page 535.

Example: `MMEM:CLE:ALL`

MMEMory:CLEar:STATe <1>, <FileName>

This command deletes an instrument configuration file.

Parameters:

<1>

<FileName> String containing the path and name of the file to delete. The string may or may not contain the file's extension.

Example: `MMEM:CLE:STAT 1, 'TEST'`

MMEMory:LOAD:AUTO <1>, <FileName>

This command restores an instrument configuration and defines that configuration as the default state.

The default state is restored after a preset ([*RST](#)) or after you turn on the R&S ZNL/ZNLE.

Parameters:

<1>

<FileName> **'Factory'**
Restores the factory settings as the default state.

'<file_name>

String containing the path and name of the configuration file. Note that only *instrument* settings files can be selected for the startup recall function; channel setup files cause an error.

Example: `MMEM:LOAD:AUTO 1, 'C:\Users\Public\Documents\Rohde-Schwarz\ZNL\user\TEST'`

Manual operation: See ["Startup Recall"](#) on page 103

MMEMory:LOAD:STATe <1>, <FileName>

This command restores and activates the instrument configuration stored in a *.dfl file.

Note that files with other formats cannot be loaded with this command.

The contents that are reloaded from the file are defined by the last selection made either in the "Save/Recall" dialogs (manual operation) or through the `MMEMory:SELEct[:ITEM]` commands (remote operation; the settings are identical in both cases).

The selection only applies to Spectrum setups, see the R&S ZNL/ZNLE Spectrum Mode User Manual. A VNA setup is always loaded in its entirety.

By default, the selection is limited to the user settings ("User Settings" selection in the dialogs, `HWSettings` in SCPI). The selection is not reset by `[Preset]` or `*RST`.

As a consequence, the results of a SCPI script using the `MMEMemory:LOAD:STATE` command without a previous `MMEMemory:SElect[:ITEM]` command may vary, depending on previous actions in the GUI or in previous scripts, even if the script starts with the `*RST` command.

It is therefore recommended that you use the appropriate `MMEMemory:SElect[:ITEM]` command before using `MMEMemory:LOAD:STATE`.

Parameters:

<1>

<FileName> String containing the path and name of the file to load.
The string may or may not include the file's extension.

Example:

```
MMEM:SEL:ALL
//Save all items (User Settings, All Traces, All Limit Lines) from
the R&S ZNL/ZNLE.
MME:LOAD:STAT 1, 'C:
\Users\Public\Documents\Rohde-Schwarz\ZNL\user\TEST01 '
//Reloads all items
In the "Recall" dialog, select only "User Settings" and "All Limit
Lines".
MME:LOAD:STAT 1, 'C:
\Users\Public\Documents\Rohde-Schwarz\ZNL\user\TEST01 '
//Reloads user settings and all limit lines.
*RST
//Reset instrument.
MME:LOAD:STAT 1, 'C:
\Users\Public\Documents\Rohde-Schwarz\ZNL\user\TEST01 '
//Selected items are retained. Reloads user settings and all limit
lines.
Restart the instrument.
(Switch the [ON/OFF] key off and on).
MME:LOAD:STAT 1, 'C:
\Users\Public\Documents\Rohde-Schwarz\ZNL\user\TEST01 '
// Selected items are set to default. Reloads only the user set-
tings.
```

Manual operation: See ["Recall"](#) on page 99

MMEMemory:LOAD:TYPE <Type>

This command defines whether the channel setups that will be loaded with the subsequent `MME:LOAD:STAT` command will replace the current channel setup or activate a new channel setup.

Parameters:

<Type> NEW | REPLace

NEW

The loaded settings will be activated in a new channel setup.

REPLace

The loaded settings will replace the currently active channel setup.

*RST: NEW

Example:

```
INST:SEL 'SPECTRUM2'
//Selects channel setup 'SPECTRUM2'.
MMEM:STOR:TYP CHAN
//Specifies that channel setup data is to be stored.
MMEM:STOR:STAT 1, 'C:\Analyzer\Spectrum'
//Stores the settings from channel setup
//'SPECTRUM2' to the file 'C:\Analyzer\Spectrum'.
MMEM:LOAD:TYPE NEW
//Specifies that channel setups are to be loaded
//in a new channel setup.
MMEM:LOAD:STAT 1, 'C:\Analyzer\Spectrum'
//Loads the channel setup from the file
//'C:\Analyzer\Spectrum' to the new channel setup
//'SPECTRUM2*'.

```

MMEMory:STORe<1|2>:STATe <1>, <FileName>

This command saves the current instrument configuration in a *.df1 file.

Suffix:

<1|2> irrelevant

Parameters:

<1>

<FileName> String containing the path and name of the target file.
The file extension is .df1.

Example:

```
MMEM:STOR:STAT 1, 'Save'
Saves the current instrument settings in the file Save.dfl.
```

Manual operation: See ["Save File"](#) on page 102

MMEMory:STORe<1|2>:STATe:NEXT

This command saves the current instrument configuration in a *.df1 file.

The file name depends on the one you have set with [MMEMory:STORe<1|2>:STATe](#) on page 542. This command adds a consecutive number to the file name.

Suffix:

<1|2> irrelevant

Example: `MMEM:STOR:STAT 1, 'Save'`
Saves the current instrument settings in the file `Save.dfl`.
`MMEM:STOR:STAT:NEXT`
Saves the current instrument settings in the file `Save_001.dfl`
`MMEM:STOR:STAT:NEXT`
Saves the current instrument settings in the file `Save_002.dfl`

Manual operation: See ["Save File"](#) on page 102

MMEMory:STORe<1|2>:TYPE <Type>

This command defines whether the data from the entire instrument or only from the current channel setup is stored with the subsequent `MMEM:STOR...` command.

Suffix:
<1|2> irrelevant

Parameters:
<Type> INSTRument | CHANnel

INSTRument
Stores data from the entire instrument.

CHANnel
Stores data from an individual channel setup.

*RST: INST

Example: `INST:SEL 'SPECTRUM2'`
Selects channel setup 'SPECTRUM2'.
`MMEM:STOR:TYPE CHAN`
Specifies that channel setup data is to be stored.

SYSTem:PRESet

This command presets the R&S ZNL/ZNLE. It is identical to `*RST`.

Example: `SYST:PRES`

Usage: Event

SYSTem:PRESet:CHANnel[:EXEC]

This command restores the default instrument settings in the current channel setup.

Use `INST:SEL` to select the channel setup.

For details see [Chapter 6.1, "Restoring the Default Instrument Configuration \(Preset\)"](#), on page 95.

Example: `INST:SEL 'Spectrum2'`
Selects the channel setup for "Spectrum2".
`SYST:PRES:CHAN:EXEC`
Restores the factory default settings to the "Spectrum2" channel setup.

Usage: Event

11.3.3.3 Storing or Printing Screenshots

Useful commands to configure screenshots described elsewhere

- `MMEMoRY:NAME` on page 538

Remote commands exclusive to configuring screenshots

<code>DISPlay:LOGO</code>	544
<code>HCOPy:ABORt</code>	545
<code>HCOPy:CONTeNt</code>	545
<code>HCOPy:CMAP<it>:DEFault<ci></code>	546
<code>HCOPy:DEStination<1 2></code>	546
<code>HCOPy:DEVice:COLor</code>	547
<code>HCOPy:DEVice:LANGUage<1 2></code>	547
<code>HCOPy[:IMMediate<1 2>]</code>	548
<code>HCOPy[:IMMediate<1 2>]:NEXT</code>	548
<code>HCOPy:ITeM:WINDow<1 2>:TEXT</code>	548
<code>HCOPy:PAGE:COUNt:STATe</code>	549
<code>HCOPy:PAGE:MARGin<1 2>:BOTTom</code>	549
<code>HCOPy:PAGE:MARGin<1 2>:LEFT</code>	549
<code>HCOPy:PAGE:MARGin<1 2>:RIGHT</code>	550
<code>HCOPy:PAGE:MARGin<1 2>:TOP</code>	550
<code>HCOPy:PAGE:MARGin<1 2>:UNIT</code>	550
<code>HCOPy:PAGE:ORientation<1 2></code>	551
<code>HCOPy:PAGE:WINDow<1 2>:CHANnel:STATe</code>	551
<code>HCOPy:PAGE:WINDow<1 2>:COUNt</code>	551
<code>HCOPy:PAGE:WINDow<1 2>:SCALE</code>	552
<code>HCOPy:PAGE:WINDow<1 2>:STATe</code>	552
<code>HCOPy:TDSamp:STATe<1 2></code>	553
<code>SYSTem:COMMunicate:PRINter:ENUMerate:FIRSt</code>	553
<code>SYSTem:COMMunicate:PRINter:ENUMerate[:NEXT]</code>	553
<code>SYSTem:COMMunicate:PRINter:SELect<1 2></code>	553

`DISPlay:LOGO <State>`

Activates/deactivates the printout of the Rohde & Schwarz company logo at the top of each page.

Parameters:

`<State>` 1 | 0 | ON | OFF

1 | ON
Logo is printed.

0 | OFF
Logo is not printed.

*RST: 1

Example: `DISP:LOGO OFF`

Manual operation: See ["Print Logo"](#) on page 108

HCOPy:ABORt

This command aborts a running hardcopy output.

Example: `HCOP:ABOR`

HCOPy:CONTent <arg0>

This command determines the type of content included in the printout.

Parameters:

<arg0>

WINDows | HCOPy

WINDows

Includes only the selected windows in the printout. All currently active windows for the current channel setup (or "MultiView") are available for selection. How many windows are printed on a each page of the printout is defined by [HCOPy:PAGE:WINDow<1|2>:COUNT](#) on page 551.

This option is not available when copying to the clipboard ([HCOP:DEST 'SYST:COMM:CLIP'](#) or an image file (see [HCOPy:DEVice:LANGuage<1|2>](#) on page 547).

If the destination is currently set to an image file or the clipboard, it is automatically changed to be a PDF file.

HCOPy

Selects all measurement results displayed on the screen for the current channel setup (or "MultiView"): diagrams, traces, markers, marker lists, limit lines, etc., including the channel setup bar and status bar, for printout on a single page. Displayed items belonging to the software user interface (e.g. softkeys) are not included. The size and position of the elements in the printout is identical to the screen display.

*RST: `HCOPy`

Example:

```
HCOP:DEST1 'SYST:COMM:CLIP'
HCOP:CONT WIND
HCOP:DEST1?
//Result: 'MMEM'
HCOP:DEV:LANG1?
//Result: 'PDF'
```

"Print to clipboard" is automatically switched to "print to PDF file" when the contents are switched to "multiple windows".

Manual operation: See ["Print Screenshot"](#) on page 108

HCOPY:CMAP<it>:DEFault<ci>

This command defines the color scheme for print jobs.

Suffix:

<it> Irrelevant.

<ci> See table below

Example:

HCOPY:CMAP:DEF2

Selects the optimized color set for the color settings of a print-out.

Manual operation: See "Print Colors" on page 126

Gui setting	Description	Remote command
"Screen Colors (Print)"	Selects the current screen colors for the printout. The background is always printed in white and the grid in black.	HCOPY:CMAP:DEF1
"Optimized Colors"	Selects an optimized color setting for the printout to improve the visibility of the colors (default setting). Trace 1 is blue, trace 2 black, trace 3 green, and the markers are turquoise. The background is always printed in white and the grid in black.	HCOPY:CMAP:DEF2
"Screen Colors (Screenshot)"	Selects the current screen colors without any changes for a screenshot.	HCOPY:CMAP:DEF4

HCOPY:DESTination<1|2> <arg0>

This command selects the destination of a print job.

Note: To print a screenshot to a file, see [HCOPY:DEVice:LANGuage<1|2>](#) on page 547.

Suffix:

<1|2> Irrelevant.

Parameters:

<arg0>

'MMEM'

Activates "Print to file". Thus, if the destination of the print function is set to "printer" (see [HCOPY:DEST1 'SYSTEM:COMMUnicate:PRINter'](#) or [HCOPY:DEV:LANG GDI](#)), the output is redirected to a .PRN file using the selected printer driver.

Select the file name with [MMEMory:NAME](#).

Note: To save a screenshot to a file, see [HCOPY:DEVice:LANGuage<1|2>](#) on page 547.

'SYSTEM:COMMUnicate:PRINter'

Sends the hardcopy to a printer and deactivates "print to file".

Select the printer with [SYSTEM:COMMUnicate:PRINter:SElect<1|2>](#).

'SYSTEM:COMMunicate:CLIPboard'

Sends the hardcopy to the clipboard.

***RST:** 'SYST:COMM:CLIP'**Example:**

To print on a printer:

```
//Destination: printer, deactivate "print to file"
HCOP:DEST1 'SYSTEM:COMMunicate:PRINter'
//Define the printer name
SYST:COMM:PRIN:SEL 'myFavoritePrinter'
//Print
HCOP:IMM
```

Example:

To print to a *PRN file:

```
//Destination: printer
HCOP:DEV:LANG GDI
//Define the printer name
SYST:COMM:PRIN:SEL 'myFavoritePrinter'
//Redirect the printer output to a file
HCOP:DEST1 'MMEM'
//Define file name
MMEM:NAME 'C:\R_S\instr\user\MeasurementTestReport.png'
//Print
HCOP:IMM
```

Manual operation: See "[Destination: Clipboard](#)" on page 113**HCOPy:DEvice:COLor <State>**

This command turns color printing on and off.

Parameters:

<State> ON | OFF | 0 | 1
ON | 1
 Color printing
OFF | 0
 Black and white printing
***RST:** 1

Example:

HCOP:DEV:COL ON

HCOPy:DEvice:LANGuage<1|2> <arg0>

This command selects the file format for a print job or to store a screenshot to a file.

Suffix:

<1|2> 1|2
 Irrelevant.

Parameters:

<arg0> GDI | BMP | PNG | JPEG | JPG | DOC | PDF | SVG | RTF

GDI

Graphics Device Interface

Default format for output to a printer configured under Windows. Must be selected for output to the printer interface.

Can be used for output to a file. The printer driver configured under Windows is used to generate a printer-specific file format.

BMP, JPG, PNG

Data format for output to files only.

Example:

To print a screenshot to a PNG file:

```
//Destination: PNG file
HCOP:DEV:LANG PNG
//Define file name
MME:NAME 'C:\R_S\instr\user\MeasurementTestReport.png'
//Print
HCOP:IMM
```

Manual operation: See "[Destination: File](#)" on page 113

HCOPy[:IMMEDIATE<1|2>]

This command initiates a print job.

If you are printing to a file, the file name depends on [MME:NAME](#).

Suffix:

<1|2> Irrelevant.

Manual operation: See "[Print](#)" on page 111

HCOPy[:IMMEDIATE<1|2>]:NEXT

This command initiates a print job.

If you are printing to a file, the file name depends on [MME:NAME](#). This command adds a consecutive number to the file name.

Suffix:

<1|2> Irrelevant. Suffix 2 is not allowed

Manual operation: See "[Print](#)" on page 111

HCOPy:ITEM:WINDOW<1|2>:TEXT <arg0>

This command defines a comment to be added to the printout.

Suffix:

<1|2> 1|2

Parameters:

<arg0> String containing the comment.

Manual operation: See "[Comment](#)" on page 108

HCOPY:PAGE:COUNT:STATe <arg0>

This command includes or excludes the page number for printouts consisting of multiple pages ([HCOPY:CONTent](#) on page 545).

Parameters:

<arg0> 1 | 0 | ON | OFF
 1 | ON
 The page number is printed.
 0 | OFF
 The page number is not printed.
 *RST: 1

Example: HCOPY:PAGE:COUN:STAT ON

Manual operation: See "[Print Page Count](#)" on page 108

HCOPY:PAGE:MARGIn<1|2>:BOTTom <arg0>

This command defines the margin at the bottom of the printout page on which no elements are printed. The margins are defined according to [HCOPY:PAGE:MARGIn<1|2>:UNIT](#) on page 550.

Suffix:

<1|2> 1|2
 Irrelevant.

Parameters:

<arg0> *RST: 4.23 mm

Example: HCOPY:PAGE:MARG2:BOTT 2

Manual operation: See "[Margins](#)" on page 115

HCOPY:PAGE:MARGIn<1|2>:LEFT <arg0>

This command defines the margin at the left side of the printout page on which no elements are printed. The margins are defined according to [HCOPY:PAGE:MARGIn<1|2>:UNIT](#) on page 550.

Suffix:

<1|2> 1|2
 Irrelevant.

Parameters:

<arg0> *RST: 4.23 mm

Example: HCOPY:PAGE:MARG2:LEFT 2

Manual operation: See "[Margins](#)" on page 115

HCOPY:PAGE:MARGin<1|2>:RIGHT <arg0>

This command defines the margin at the right side of the printout page on which no elements are printed. The margins are defined according to [HCOPY:PAGE:MARGin<1|2>:UNIT](#) on page 550.

Suffix:

<1|2> 1|2
Irrelevant.

Parameters:

<arg0> *RST: 4.23 mm

Example: HCOPY:PAGE:MARG2:RIGHT 2

Manual operation: See "[Margins](#)" on page 115

HCOPY:PAGE:MARGin<1|2>:TOP <arg0>

This command defines the margin at the top of the printout page on which no elements are printed. The margins are defined according to [HCOPY:PAGE:MARGin<1|2>:UNIT](#) on page 550.

Suffix:

<1|2> 1|2
Irrelevant.

Parameters:

<arg0> *RST: 4.23 mm

Example: HCOPY:PAGE:MARG2:TOP 2

Manual operation: See "[Margins](#)" on page 115

HCOPY:PAGE:MARGin<1|2>:UNIT <arg0>

This command defines the unit in which the margins for the printout page are configured.

Suffix:

<1|2> 1|2
Irrelevant.

Parameters:

<arg0> MM | IN
MM
millimeters
IN
inches
*RST: MM

Example: HCOPY:PAGE:MARG2:BOTTOM 2

Manual operation: See "[Margins](#)" on page 115

HCOPY:PAGE:ORientation<1|2> <arg0>

The command selects the page orientation of the printout.

The command is only available if the output device is a printer or a PDF file.

Suffix:

<1|2> 1|2
Irrelevant.

Parameters:

<arg0> LANDscape | PORTrait
*RST: PORTrait

Example:

```
HCOP:DEV:LANG1 PDF
HCOP:PAGE:ORI2 LAND
```

Manual operation: See "[Orientation](#)" on page 114

HCOPY:PAGE:WINDow<1|2>:CHANnel:STATe <arg0>, <arg1>

This command selects all windows of the specified channel setup to be included in the printout for [HCOPY:CONTent](#) on page 545.

Suffix:

<1|2> irrelevant

Parameters:

<arg0> String containing the name of the channel setup.
For a list of available channel setup types use [INSTrument:LIST?](#) on page 528.

<arg1> 1 | 0 | ON | OFF
1 | ON
The channel setup windows are included in the printout.
0 | OFF
The channel setup windows are not included in the printout.
*RST: 1

Example:

```
HCOP:CONT WIND
HCOP:PAGE:WIND2:CHAN 'IQ Analyzer',0
HCOP:PAGE:WIND2:STAT 'IQ Analyzer','1',1
Prints only window 1 in the IQ Analyzer channel setup.
```

Manual operation: See "[Print Multiple Windows](#)" on page 108

HCOPY:PAGE:WINDow<1|2>:COUNT <arg0>

This command defines how many windows are displayed on a single page of the printout for [HCOPY:CONTent](#) on page 545.

Suffix:

<1|2> irrelevant

Parameters:

<arg0> integer
*RST: 1

Example:

HCOPY:PAGE:WIND2:COUNT 2

Manual operation: See "[Windows Per Page](#)" on page 115

HCOPY:PAGE:WINDow<1|2>:SCALE <arg0>

This command determines the scaling of the windows in the printout for [HCOPY:CONTent](#) on page 545.

Suffix:

<1|2> irrelevant

Parameters:

<arg0> 1 | 0 | ON | OFF

1 | ON

Each window is scaled to fit the page size optimally, not regarding the aspect ratio of the original display. If more than one window is printed on one page (see [HCOPY:PAGE:WINDow<1|2>:COUNT](#) on page 551), each window is printed in equal size. ("Size to fit")

0 | OFF

Each window is printed as large as possible while maintaining the aspect ratio of the original display. ("Maintain aspect ratio")

*RST: 1

Example:

HCOPY:PAGE:WIND2:SCALE 0

Manual operation: See "[Scaling](#)" on page 115

HCOPY:PAGE:WINDow<1|2>:STATe <arg0>, <arg1>, <arg2>

This command selects the windows to be included in the printout for [HCOPY:CONTent](#) on page 545.

Suffix:

<1|2> irrelevant

Parameters:

<arg0> String containing the name of the channel setup.
For a list of available channel setup types use [INSTrument:LIST?](#) on page 528.

<arg1> String containing the name of the existing window.
By default, the name of a window is the same as its index.

<arg2> 1 | 0 | ON | OFF

1 | ON

The window is included in the printout.

0 | OFF

The window is not included in the printout.

*RST: 1

Example: `HCOP:PAGE:WIND2:STAT 'IQ Analyzer','1',1`

Manual operation: See ["Print Multiple Windows"](#) on page 108

HCOPy:TDSTamp:STATe<1|2> <arg0>

This command includes or excludes the time and date in the printout.

Suffix:

<1|2> 1|2
Irrelevant.

Parameters:

<arg0> 1 | 0 | ON | OFF
1 | ON
The time and date are printed.
0 | OFF
The time and date are not printed.
*RST: 1

Manual operation: See ["Print Date and Time"](#) on page 109

SYSTem:COMMunicate:PRINter:ENUMerate:FIRSt

This command queries the name of the first available printer.

To query the name of other installed printers, use `SYSTem:COMMunicate:PRINter:ENUMerate[:NEXT]` on page 553.

Manual operation: See ["Printer Name"](#) on page 113

SYSTem:COMMunicate:PRINter:ENUMerate[:NEXT]

This command queries the name of available printers.

You have to use `SYSTem:COMMunicate:PRINter:ENUMerate:FIRSt` on page 553 for this command to work properly.

Manual operation: See ["Printer Name"](#) on page 113

SYSTem:COMMunicate:PRINter:SElect<1|2> <arg0>

This command selects the printer that processes jobs sent by the R&S ZNL/ZNLE.

Use `HCOPy:DESTination<1|2>` to select another output destination.

Suffix:

<1|2> 1|2
Irrelevant.

Parameters:

<arg0> String containing the printer name.
Use
 • `SYSTem:COMMunicate:PRINter:ENUMerate:FIRSt` on page 553 and
 • `SYSTem:COMMunicate:PRINter:ENUMerate[:NEXT]` on page 553
 to query all available printers.
 *RST: NONE

Manual operation: See "Printer Name" on page 113

11.3.3.4 Storing Measurement Results

The following commands can be used to store the results of a measurement.

11.3.3.5 Examples: Managing Data

• Storing Data.....	554
• Loading Data.....	555
• Storing Instrument Settings.....	555
• Loading Instrument Settings.....	556
• Printing to a File.....	556
• Printing on a Printer.....	556
• Storing Multiple Graphical Measurement Results to a PDF File.....	557

Storing Data

```
MMEM:MSIS 'C:'
//Selects drive C: as the default storage device.

//-----Connecting a network drive-----
MMEM:NETW:USED?
//Returns a list of all drives in use in the network.
MMEM:NETW:UNUS?
//Returns a list of free drive names in the network.
MMEM:NETW:MAP 'Q:', 'Server\ACLRTest'
//Maps drive Q: to the directory 'Server\ACLRTest'

//-----Saving data on the instrument-----
MMEM:MDIR 'C:\R_S\INSTR\USER\Results'
//Creates a directory called 'Results' on drive C:
MMEM:NAME 'C:\R_S\INSTR\USER\Results\Test001.txt'
//Defines a file called 'Test001.txt'
MMEM:COMM 'ACLR test results'
```

```
//Creates a comment for the settings to be displayed in gui.
MMEM:DATA 'Test001.txt',#212FileContents
//Creates the file 'Test001.txt'and writes 12 characters to it

//-----Copying the data to another location---
MMEM:COPY 'C:\R_S\INSTR\USER\Results\Test001.txt','Q:'
//Copies the specified file to network drive Q:.
MMEM:DEL 'C:\R_S\INSTR\USER\Results\Test001.txt'
//Deletes the specified file from the instrument hard disk.
//or
//MMEM:MOVE 'C:\R_S\INSTR\USER\Results\Test001.xml','Q:\TestResults.txt'//
//Moves the file 'Test001.txt' to drive Q:, renames it to 'Testresults.txt'
//and removes it from the instrument hard disk.
MMEM:RDIR 'C:\R_S\INSTR\USER\Results'
//Deletes the directory called 'Results' from drive C:, unless it still
//contains any content.

//-----Disconnecting the network drive---
MMEM:NETW:DISC 'Q:'
//Disconnect drive Q:.
```

Loading Data

```
MMEM:CDIR?
//Returns the path of the current directory.
//e.g.
C:\R_S\Instr\user\
MMEM:CDIR 'C:\R_S\INSTR\USER\Results'
//Changes the current directory.
MMEM:CAT? 'C:\R_S\INSTR\USER\Results\*.xml'
//or
MMEM:CAT? '*.xml'
//Returns a list of all xml files in the directory 'C:\R_S\INSTR\USER\Results'.
MMEM:CAT:LONG? '*.xml'
//Returns additional information about the xml files in the directory
// 'C:\R_S\INSTR\USER\Results'.
```

Storing Instrument Settings

In this example we will store the instrument settings for the "Spectrum" channel setup.

```
INST:SEL 'SPECTRUM'
//Selects measurement channel 'SPECTRUM'.
MEMM:STOR:TYPE CHAN
//Specifies that channel-specific data is to be stored.
MMEM:STOR:STAT 1, 'C:\R_S\Instr\user\Spectrum'
//Stores the channel settings from the 'Spectrum' channel
// to the file 'Spectrum.dfl'.
```

Loading Instrument Settings

In this example we will load the hardware settings from the configuration file `Spectrum.dfl` to a new "Spectrum2" channel setup.

```
MEMM:LOAD:TYPE NEW
//Specifies that settings will be loaded to a new channel besides the existing
//'Spectrum' channel.
MEMM:SEL:CHAN:HWS ON
//Selects only hardware settings to be loaded.
MEMM:LOAD:STAT 1, 'C:\R_S\Instr\user\Spectrum'
//Loads the channel-specific settings from the file 'C:\R_S\Instr\user\Spectrum.dfl'
//to a new channel. The new channel is named 'Spectrum2' to avoid a naming conflict
//with the existing 'Spectrum' channel.
INST:REN 'Spectrum2','Spectrum3'
//Renames the loaded channel to 'Spectrum3'.
```

Printing to a File

```
//Select bmp as the file format.
HCOP:DEV:LANG BMP
//Select the file name for the printout.
MEMM:NAME 'C:\R_S\INSTR\USER\Screenshot.bmp'
//Select all screen elements for printing
HCOP:ITEM:ALL
//Add a comment to the printout.
HCOP:ITEM:WIND:TEXT 'ACLRResults'
//Store the printout in a file called 'Screenshot.bmp'.
HCOP
//Store another printout in a file called 'Screenshot_001.bmp'.
HCOP:NEXT
```

Printing on a Printer

```
HCOP:DEST2 'SYST:COMM:PRIN'
//Prints the data on a printer.
SYST:COMM:PRIN:ENUM:FIRS?
SYST:COMM:PRIN:ENUM?
//Returns the available printers, e.g.
//'LASER on LPT1'
//''
//Means that one printer is available.
SYST:COMM:PRIN:SEL2 'LASER on LPT1'
//Selects the printer for the print job on device 2.
HCOP:PAGE:ORI2 LAND
//Selects the landscape format for the printout.
HCOP:TDST:STAT2 ON
//Includes date and time on the printout.
HCOP:ITEM:ALL
//Prints all screen elements
```

```
HCOP
//Initiates the printout.
```

Storing Multiple Graphical Measurement Results to a PDF File

This example demonstrates how to store graphical results from measurements in the Spectrum application and the I/Q Analyzer to a single PDF file. It assumes the Spectrum and I/Q Analyzer measurements have already been configured and performed, with the following screen layout:

'Spectrum': 1 Frequency Sweep

'Spectrum': 2 Spectrogram

'IQ Analyzer': 1 Magnitude

'IQ Analyzer': 2 Spectrum

```
//Switch to MultiView tab
DISP:ATAB ON

//Select windows to be stored to file
HCOP:CONT WIND
HCOP:PAGE:WIND:STAT 'Spectrum','1',ON
HCOP:PAGE:WIND:STAT 'Spectrum','2',ON
HCOP:PAGE:WIND:STAT 'IQ Analyzer','1',ON
HCOP:PAGE:WIND:STAT 'IQ Analyzer','2',ON

//Define contents to be printed on each page (logo, timestamp, page count)
DISP:LOGO ON
HCOP:TDST:STAT ON
HCOP:PAGE:COUN:STAT ON
//Define comment to be printed on each page
HCOP:ITEM:WIND:TEXT 'Measurement Test Report'

//Configure page layout (landscape, 1 display per page, margins 2cm on each side)
HCOP:PAGE:ORI1 LAND
HCOP:PAGE:WIND1:COUN 1
HCOP:PAGE:WIND1:SCAL 1
HCOP:PAGE:MARG1:BOTT 20
HCOP:PAGE:MARG1:LEFT 20
HCOP:PAGE:MARG1:RIGH 20
HCOP:PAGE:MARG1:TOP 20

//Configure the use of optimized colors for printout
HCOP:CMAP:DEF2

//Set format of printout to PDF.
HCOP:DEV:LANG1 PDF
//Define file name of printout
MMEM:NAME 'C:\R_S\instr\user\MeasurementTestReport.pdf'
```

```
//Store pdf of printout to file
HCOP:IMM
```

11.3.4 Configuring the R&S ZNL/ZNLE

The remote commands required to set up the R&S ZNL/ZNLE are described here.

• Configuring the Reference Frequency	558
• Calibration and Checks	558
• Customizing the Screen Layout	561
• Remote Commands for Language Settings	566
• Configuring the Network and Remote Control	567
• Checking the System Configuration	570
• Using Service Functions	574

11.3.4.1 Configuring the Reference Frequency

[SENSe:]ROSCillator:SOURce	558
--	-----

[SENSe:]ROSCillator:SOURce <Source>

This command selects the reference oscillator.

If you want to select the external reference, it must be connected to the R&S ZNL/ZNLE.

Parameters:

<Source>

INTernal

The internal reference is used (10 MHz)

EXTernal

The external reference from the "REF INPUT 10 MHZ" connector is used; if none is available, an error flag is displayed in the status bar

Example:

ROSC:SOUR EXT

11.3.4.2 Calibration and Checks

The following commands control calibration and checks on the R&S ZNL/ZNLE.

CALibration[:ALL]?	559
CALibration:RESult?	559
DIAGnostic:SERVice:INPut:PULSed:CFRequency	559
DIAGnostic:SERVice:INPut:PULSed:MCFRequency	560
DIAGnostic:SERVice:INPut:RF[:SPECtrum]	560
DIAGnostic:SERVice:INPut[:SELect]	560
DIAGnostic:SERVice:STESt:RESult?	560
SOURce<si>:TEMPerature:FRONTend	561

CALibration[:ALL]?

This command initiates a calibration (self-alignment) routine and queries if calibration was successful.

During the acquisition of correction data the instrument does not accept any remote control commands.

In order to recognize when the acquisition of correction data is completed, the MAV bit in the status byte can be used. If the associated bit is set in the Service Request Enable (SRE) register, the instrument generates a service request after the acquisition of correction data has been completed.

Return values:

<CalibrationFailed> ON | OFF | 0 | 1
OFF | 0
 Calibration was successful.
ON | 1
 Calibration was not successful.

Example:

```
*CLS
Resets the status management.
*SRE 16
Enables MAV bit in the Service Request Enable register.
*CAL?
Starts the correction data recording, and then a service request
is generated.
```

Usage: Query only

CALibration:RESult?

This command returns the results collected during calibration.

Return values:

<CalibrationData> String containing the calibration data.

Example:

```
CAL:RES?
would return, e.g.
Total Calibration Status:
PASSED, Date (dd/mm/yyyy): 12/07/2004,
Time: 16:24:54, Runtime: 00.06
```

Usage: Query only

DIAGnostic:SERvice:INPut:PULSed:CFrequency <Frequency>

This command defines the frequency of the calibration signal.

Before you can use the command, you have to feed in a calibration signal with [DIAGnostic:SERvice:INPut\[:SElect\]](#) on page 560.

Manual operation: See "[Calibration Frequency RF](#)" on page 139

DIAGnostic:SERVice:INPut:PULSed:MCFRequency <Frequency>

This command sets the calibration frequency for frequencies greater than 7 GHz. This command only takes effect if a microwave calibration signal is selected for input ([DIAGnostic:SERVice:INPut\[:SELect\]](#) on page 560).

Parameters:

<Frequency> *RST: 7 GHz
 Default unit: Hz

Example: DIAG:SERV:INP:PULS:MCFR 7,1 GHz

DIAGnostic:SERVice:INPut:RF[:SPECTrum] <Bandwidth>

This command selects the bandwidth of the calibration signal.

Parameters:

<Bandwidth> NARRowband | BROadband
 NARRowband
 Narrowband signal for power calibration of the frontend.
 BROadband
 Broadband signal for calibration of the IF filter.

DIAGnostic:SERVice:INPut[:SELect] <Signal>

This command activates or deactivates the use of an internal calibration signal as input for the R&S ZNL/ZNLE.

Parameters:

<Signal> **CALibration**
 Uses the calibration signal as RF input.
 RF
 Uses the signal from the RF input.
 *RST: RF

Example: DIAG:SERV:INP CAL
 Uses the calibration signal as RF input.

Manual operation: See " **NONE** " on page 139

DIAGnostic:SERVice:STESt:RESult?

This command queries the self-test results.

Return values:

<Results> String of data containing the results.
 The rows of the self-test result table are separated by commas.

Example: `DIAG:SERV:STES:RES?`
 would return, e.g.
 "Total Selftest Status:
 PASSED", "Date (dd/mm/yyyy): 09/07/2004 TIME:
 16:24:54", "Runtime: 00:06", "..."

Usage: Query only

SOURce<si>:TEMPerature:FRONTend

This command queries the current frontend temperature of the R&S ZNL/ZNLE.

During self-alignment, the instrument's (frontend) temperature is also measured (as soon as the instrument has warmed up completely). This temperature is used as a reference for a continuous temperature check during operation. If the current temperature deviates from the stored self-alignment temperature by a certain degree, a warning is displayed in the status bar indicating the resulting deviation in the measured power levels. A status bit in the `STATUS:QUESTIONABLE:TEMPerature` register indicates a possible deviation.

Suffix:
 <si> irrelevant

Return values:
 <Temperature> Temperature in degrees Celsius.

Example: `SOUR:TEMP:FRON?`
 Queries the temperature of the frontend sensor.

11.3.4.3 Customizing the Screen Layout

The remote commands required to set up the display of the R&S ZNL/ZNLE are described here.

- [General Display Settings and Items](#).....561
- [Colors and Themes](#).....565

General Display Settings and Items

The following commands add, remove or customize general display and screen elements.

Remote commands exclusive to general display settings

DISPlay:ANNotation:CBAR	562
DISPlay:BLIGHting	562
DISPlay:ANNotation:FREQuency	562
DISPlay:SBAR[:STATe]	562
DISPlay:SKEYs[:STATe]	563
DISPlay:TBAR[:STATe]	563
DISPlay:TOUCHscreen[:STATe]	563
DISPlay[:WINDow<n>]:TIME	563
DISPlay[:WINDow<n>]:TIME:FORMat	564

SYSTem:DISPlay:FPANel[:STATe]	564
SYSTem:DATE	564
SYSTem:TIME	565

DISPlay:ANNotation:CBAR <State>

This command hides or displays the channel bar information.

Parameters:

<State> ON | OFF | 0 | 1
 *RST: 1

Example: DISP:ANN:CBAR OFF

Manual operation: See "[Channel Bar](#)" on page 123

DISPlay:BLIGHting <Brightness>

Changes the brightness of the display in eight steps.

Parameters:

<Brightness> integer
 Range: 0 to 7
 *RST: 3

Example: DISP:BLIG 3
 Reduces the brightness of the display.

Manual operation: See "[Background Lighting](#)" on page 122

DISPlay:ANNotation:FREQuency <State>

This command turns the label of the x-axis on and off.

Parameters:

<State> ON | OFF | 0 | 1
 *RST: 1

Example: DISP:ANN:FREQ OFF

Manual operation: See "[Diagram Footer \(Annotation\)](#)" on page 123

DISPlay:SBAR[:STATe] <State>

This command turns the status bar on and off.

Parameters:

<State> ON | OFF | 0 | 1
 *RST: 1

Example: DISP:SBAR:OFF

Manual operation: See "[Status Bar](#)" on page 123

DISPlay:SKEYs[:STATe] <State>

This command turns the softkey bar on and off.

Parameters:

<State> ON | OFF | 0 | 1
*RST: 1

Example: DISP:SKEY:OFF

Manual operation: See "[Softkey Bar](#)" on page 123

DISPlay:TBAR[:STATe] <State>

This command turns the toolbar on or off.

Parameters:

<State> ON | OFF | 1 | 0
*RST: 0

Example: DISP:TBAR ON

Manual operation: See "[Toolbar](#)" on page 123

DISPlay:TOUCHscreen[:STATe] <State>

This command controls the touch screen functionality.

Parameters:

<State> ON | FRAME | OFF
ON | 1
Touch screen is active for entire screen
OFF | 0
Touch screen is inactivate for entire screen
FRAME
Touch screen is inactivate for the diagram area of the screen,
but active for softkeys, toolbars and menus.
*RST: 1

Example: DISP:TOUC:STAT ON

Manual operation: See "[Deactivating and Activating the Touchscreen](#)" on page 121

DISPlay[:WINDow<n>]:TIME <State>

This command adds or removes the date and time from the display.

Suffix:

<n> irrelevant

Parameters:

<State> ON | OFF | 1 | 0
 *RST: 0

Example: DISP:TIME ON

Manual operation: See ["Date and Time"](#) on page 123

DISPlay[:WINDow<n>]:TIME:FORMat <Format>

This command selects the time and date format.

Suffix:

<n> irrelevant

Parameters:

<Format> US | DE
DE
 dd.mm.yyyy hh:mm:ss
 24 hour format.
US
 mm/dd/yyyy hh:mm:ss
 12 hour format.
 *RST: DE

Example: DISP:TIME ON
 Switches the screen display of date and time on.
 DISP:TIME:FORM US
 Switches the date and time format to US.

Manual operation: See ["Date and Time Format"](#) on page 122

SYSTem:DISPlay:FPANel[:STATe] <State>

This command includes or excludes the front panel keys when working with the remote desktop.

Parameters:

<State> ON | OFF | 0 | 1
 *RST: 1

Manual operation: See ["Front Panel"](#) on page 124

SYSTem:DATE <Year>, <Month>, <Day>

Configures the date on the instrument.

Parameters:

<Year>
 <Month>
 <Day>

Example: `SYST:DATE 2020,04,23`

Manual operation: See " [Set Date and Time](#) " on page 121

SYSTem:TIME <Year>, <Month>, <Day>

Configures the time on the internal real-time clock on the instrument.

Parameters:

<Hour> Range: 0 to 23

<Minutes> Range: 0 to 59

<Seconds> Range: 0 to 59

Example: `SYST:TIME 10,52,33`

Manual operation: See " [Set Date and Time](#) " on page 121

Colors and Themes

Useful commands to customize display colors described elsewhere

The `HCOPY` commands define the print colors and thus only take effect on the display colors, if the display shows the printing colors.

- [HCOPY:CMAP<it>:DEFault<ci>](#) on page 546

Remote commands exclusive to customize the display colors and themes

DISPlay:CMAP<it>:DEFault<ci>	565
DISPlay:THEMe:CATalog?	566
DISPlay:THEMe:SElect	566

DISPlay:CMAP<it>:DEFault<ci>

This command selects the color scheme for the display. The query returns the default color scheme.

Suffix:

<it> Irrelevant.

<ci> 1
Default color set 1 with a black background and white grid.
2
Default color set 2 with a white background and a black grid.
Suffix irrelevant for query

Return values:

<DefScheme> 1 | 2 | 3

The default color scheme used for the screen, as specified by the <ci> suffix.

Example: `DISP:CMAP:DEF2`
 Selects default setting 2 (white background and a black grid) for screen colors.
`DISP:CMAP:DEF?`
`//Result: 2`

DISPlay:THEMe:CATalog?

This command queries all available display themes.

Return values:

<Themes> String containing all available display themes.

Example: `DISP:THEMe:CAT?`

Usage: Query only

DISPlay:THEMe:SElect <Theme>

This command selects the display theme.

Parameters:

<Theme> String containing the name of the theme.
 *RST: SPL

Example: `DISP:THEM:SEL "BlueOcean"`

Manual operation: See "[Theme](#)" on page 126

11.3.4.4 Remote Commands for Language Settings

[SYSTem:DISPlay:LANGuage](#)..... 566

SYSTem:DISPlay:LANGuage <Language>

Defines the language of the software-defined interface elements (such as softkeys, dialog boxes, diagram texts etc.).

Parameters:

<Language> 'EN' | 'ZH_CH' | 'ZH_TW' | 'JA' | 'KO' | 'RU'
 'ZH_CH'
 Simplified Chinese
 'ZH_TW'
 Traditional Chinese
 *RST: 'EN'

Example: `SYST:DISP:LANG 'JA'`
 Switches the language of the instrument to Japanese.

11.3.4.5 Configuring the Network and Remote Control

The following commands are required to configure a network or remote control for the R&S ZNL/ZNLE.

Remote commands exclusive to configuring a network and remote control

SYSTem:COMMunicate:GPIB[:SELF]:ADDRess.....	567
SYSTem:COMMunicate:GPIB[:SELF]:RTERminator.....	567
SYSTem:DISPlay:LOCK.....	568
SYSTem:DISPlay:UPDate.....	568
SYSTem:ERRor:DISPlay.....	568
SYSTem:IDENtify:FACTory.....	569
SYSTem:IDENtify[:STRing].....	569
SYSTem:KLOCK.....	569
SYSTem:LANGuage.....	569
SYSTem:LXI:INFO.....	569
SYSTem:LXI:LANReset.....	570
SYSTem:LXI:MDEscription.....	570
SYSTem:LXI:PASSword.....	570
SYSTem:REVisIon:FACTory.....	570

SYSTem:COMMunicate:GPIB[:SELF]:ADDRess <Address>

This command sets the GPIB address of the R&S ZNL/ZNLE.

Parameters:

<Address>	Range:	0 to 30
	*RST:	(no influence on this parameter, factory default 20)

Example: SYST:COMM:GPIB:ADDR 18

Manual operation: See "GPIB Address" on page 159

SYSTem:COMMunicate:GPIB[:SELF]:RTERminator <Terminator>

This command selects the GPIB receive terminator.

Output of binary data from the instrument to the control computer does not require such a terminator change.

Parameters:

<Terminator> LFEOI | EOI

LFEOI

According to the standard, the terminator in ASCII is <LF> and/or <EOI>.

EOI

For binary data transfers (e.g. trace data) from the control computer to the instrument, the binary code used for <LF> might be included in the binary data block, and therefore should not be interpreted as a terminator in this particular case. This can be avoided by using only the receive terminator EOI.

*RST: LFEOI

Example: SYST:COMM:GPIB:RTER EOI

Manual operation: See "[GPIB Terminator](#)" on page 160

SYSTem:DISPlay:LOCK <State>

Defines whether the "Display Update" function remains available in remote operation or not.

Parameters:

<State> ON | OFF | 0 | 1

OFF | 0

The function remains available.

ON | 1

The function is not available and the display is not updated during remote operation.

*RST: 0

SYSTem:DISPlay:UPDate <State>

This command turns the display during remote operation on and off.

If on, the R&S ZNL/ZNLE updates the diagrams, traces and display fields only.

The best performance is obtained if the display is off during remote control operation.

Parameters:

<State> ON | OFF | 1 | 0

*RST: 0

Example: SYST:DISP:UPD ON

Manual operation: See "[Remote Display Update](#)" on page 160

SYSTem:ERRor:DISPlay <State>

This command the error display during remote operation on and off.

If activated, the R&S ZNL/ZNLE displays a message box at the bottom of the screen that contains the most recent type of error and the command that caused the error.

Parameters:

<State> ON | OFF | 1 | 0

*RST: 0

Example: SYST:ERR:DISP ON

Manual operation: See "[Display Remote Errors](#)" on page 160

SYSTem:IDENtify:FACTory

This command resets the query to *IDN? to its default value.

Manual operation: See ["Reset to Factory String"](#) on page 159

SYSTem:IDENtify[:STRing] <String>

This command defines the response to *IDN?.

Parameters:

<String> String containing the description of the instrument.

Manual operation: See ["Identification String"](#) on page 159

SYSTem:KLOCK <State>

This command activates the local lockout (remote control) or returns to the local mode.

Parameters:

<State> **ON**
 LLO (local lockout)
 OFF
 GTL (go to local)
 *RST: OFF

Example: SYST:KLOC ON
 Activates LLO (remote control)

Manual operation: See ["Local"](#) on page 165

SYSTem:LANGuage <Language>

This function is used to emulate previous R&S signal and spectrum analyzers.

Parameters:

<Language> "FSV" | "SCPI"
 *RST: SCPI

Example: SYST:LANG FSV
 The commands and settings for the R&S FSV instrument are used.

Manual operation: See ["Language"](#) on page 161

SYSTem:LXI:INFO

This command queries the "LXI" settings.

Return values:

<LXIInfo> <current version> | <LXI class> | <Computername> |
 <MAC adress> | <IP adress> | <Auto MDIX>

String containing the current "LXI" parameters.

- <version>
- <LXIclass>
- <ComputerName>
- <MACAddress>
- <IPAddress>
- <AutoMDIX>

SYSTem:LXI:LANReset

This command resets the LAN configuration, as well as the "LXI" password and instrument description.

Manual operation: See "[LXI Reset](#)" on page 163

SYSTem:LXI:MDEscription <Description>

This command defines the "LXI" instrument description.

Parameters:

<Description> String containing the instrument description.

SYSTem:LXI:PASSword <Password>

This command defines the "LXI" password.

Parameters:

<Password> String containing the password.

Manual operation: See "[LAN Password](#)" on page 163

SYSTem:REVision:FACTory

Resets the response to the `REV?` query to the factory default value.

Usage: Event

11.3.4.6 Checking the System Configuration

The following commands are required to check the system configuration on the R&S ZNL/ZNLE.

Useful commands for obtaining system information described elsewhere:

- [DIAGnostic:SERvice:SINfo?](#) on page 575

Remote commands exclusive to obtaining system information:

DIAGnostic:SERvice:BATTery:LEVel?	571
DIAGnostic:SERvice:BIOSinfo?	571
DIAGnostic:SERvice:HWINfo?	571

DIAGnostic:SERvice:VERsinfo?.....	572
SYSTem:ERRor:CLEar:ALL.....	572
SYSTem:ERRor:CLEar:REMOte.....	572
SYSTem:ERRor:LIST?.....	572
SYSTem:ERRor[:NEXT]?.....	573
SYSTem:FIRMware:UPDate.....	573
SYSTem:FORMat:IDENT.....	573
SYSTem:PRESet:COMPAtible.....	574

DIAGnostic:SERvice:BATTery:LEVel?

Queries the joint charge state of the internal batteries (with internal battery pack option R&S FPL1-B31).

Internal LiIon batteries are not available for R&S ZNLE.

Return values:

<ChargeState> numeric value
 Charge state in percent
 Range: 0 to 100

Example: `DIAG:SERV:BATT:LEV?`

Usage: Query only

DIAGnostic:SERvice:BIOSinfo?

This command queries the BIOS version of the CPU board.

Return values:

<BiosInformation> String containing the BIOS version.

Example: `DIAG:SERV:BIOS?`
 Returns the BIOS version.

Usage: Query only

DIAGnostic:SERvice:HWInfo?

This command queries hardware information.

Return values:

<Hardware> String containing the following information for every hardware component.
 <component>: name of the hardware component
 <serial#>: serial number of the component
 <order#>: order number of the component
 <model>: model of the component
 <code>: code of the component
 <revision>: revision of the component
 <subrevision>: subrevision of the component

Example: `DIAG:SERV:HWIN?`
 Queries the hardware information.
`"FRONTEND|100001/003|1300.3009|03|01|00|00",`
`"MOTHERBOARD|123456/002|1300.3080|02|00|00|00",`
 . . .

Usage: Query only

DIAGnostic:SERVice:VERSinfo?

This command queries information about the hardware and software components.

Return values:

<Information> String containing the version of hardware and software components including the types of licenses for installed options.

Example: `DIAG:SERV:VERS?`
 Queries the version information.
 Response:

Usage: Query only

SYSTem:ERRor:CLEar:ALL

This command deletes all contents of the "System Messages" table.

Example: `SYST:ERR:CLE:ALL`

SYSTem:ERRor:CLEar:REMote

This command deletes all contents of the "Remote Errors" table.

Note: The remote error list is automatically cleared when the R&S ZNL/ZNLE is shut down.

Example: `SYST:ERR:CLE:REM`

Manual operation: See ["Display Remote Errors"](#) on page 160

SYSTem:ERRor:LIST? [<MessType>]

This command queries the error messages that occur during R&S ZNL/ZNLE operation.

Query parameters:

<MessType> `SMSG | REMote`

SMSG

(default) Queries the system messages which occurred during manual operation.

REMOte

Queries the error messages that occurred during remote operation.

Note: The remote error list is automatically cleared when the R&S ZNL/ZNLE is shut down.

Return values:

<SystemMessages> String containing all messages in the "System Messages" table.

<RemoteErrors> <Error_no> | <Description> | <Command> | <Date> | <Time>
Comma-separated list of errors from the "Remote Errors" table, where:
<Error_no>: device-specific error code
<Description>: brief description of the error
<Command>: remote command causing the error
<Date>|<Time>: date and time the error occurred

Usage: Query only

SYSTem:ERRor[:NEXT]?

This command queries the most recent error queue entry and deletes it.

Positive error numbers indicate device-specific errors, negative error numbers are error messages defined by SCPI. If the error queue is empty, the error number 0, "No error", is returned.

Usage: Query only

SYSTem:FIRMware:UPDate <Directory>

This command starts a firmware update using the *.msi files in the selected directory. The default path is D:\FW_UPDATE. The path is changed via the [MMEMory:COMMeNt](#) command. To store the update files the [MMEMory:DATA](#) command is used.

Only user accounts with administrator rights can perform a firmware update.

Setting parameters:

<Directory>

Example: `SYST:FIRM:UPD 'D:\FW_UPDATE'`
Starts the firmware update from directory "D:\FW_UPDATE".

SYSTem:FORMat:IDENt <IDNFormat>

This command selects the response format to the [*IDN?](#) query.

Parameters:

<IDNFormat> **NEW | FSL**
R&S ZNL/ZNLE format
Format is also compatible to the R&S FSL and R&S FSV family
***RST:** not reset!

SYSTem:PRESet:COMPAtible <OpMode>

This command defines the operating mode that is activated when you switch on the R&S ZNL/ZNLE or press the [PRESET] key.

Parameters:

<OpMode>

VNA

Defines the Vector Network Analysis mode as the presetting (default).

SANalyzer

Defines Signal and Spectrum Analyzer operating mode as the presetting.

Manual operation: See "[Preset Mode](#)" on page 135

11.3.4.7 Using Service Functions

DIAGnostic:SERVice:SFUNction	574
DIAGnostic:SERVice:SFUNction:LASTresult?	574
DIAGnostic:SERVice:SFUNction:RESults:DELe	575
DIAGnostic:SERVice:SFUNction:RESults:SAVE	575
DIAGnostic:SERVice:SIINfo?	575
SYSTem:PASSword[:CENable]	576
SYSTem:PASSword:RESet	576

DIAGnostic:SERVice:SFUNction <ServiceFunction>

This command starts a service function.

The service functions are available after you have entered the level 1 or level 2 system password.

Parameters for setting and query:

<ServiceFunction> String containing the ID of the service function.
The ID of the service function is made up out of five numbers, separated by a point.

- function group number
- board number
- function number
- parameter 1 (see the Service Manual)
- parameter 2 (see the Service Manual)

Example: DIAG:SERV:SFUN 'Function1'
 DIAG:SERV:SFUN? 'Function2'

Manual operation: See "[Service Function](#)" on page 140

DIAGnostic:SERVice:SFUNction:LASTresult?

This command queries the results of the most recent service function you have used.

Return values:

<Result>

Usage: Query only**DIAGnostic:SERVice:SFUNction:RESults:DELete**

This command deletes the results of the most recent service function you have used.

Usage: Event**Manual operation:** See ["Clear Results"](#) on page 141**DIAGnostic:SERVice:SFUNction:RESults:SAVE** [<FileName>]

This command saves the results of the most recent service function you have used.

Parameters:

<FileName> String containing the file name.

Manual operation: See ["Save Results"](#) on page 141**DIAGnostic:SERVice:SINFo?**

This command creates a *.zip file with important support information. The *.zip file contains the system configuration information ("device footprint"), the current eeprom data and a screenshot of the screen display (if available).

As a result of this command, the created file name (including the drive and path) is returned.

If you contact the Rohde&Schwarz support to get help for a certain problem, send this file to the support in order to identify and solve the problem faster.

Return values:

<FileName> String containing the drive, path and file name of the created support file, where the file name consists of the following elements:

- <R&S Device ID>**: The unique R&S device ID indicated in the "Versions + Options" information
- <CurrentDate>**: The date on which the file is created (<YYYYMMDD>)
- <CurrentTime>**: The time at which the file is created (<HHMMSS>)

Example: `DIAG:SERV:SINF?`
Result:

Usage: Query only**Manual operation:** See ["Create R&S Support Information"](#) on page 137

SYSTem:PASSword[:CENable] <arg0>

Provides a password for subsequent service functions.

Parameters:

<arg0> string

Example: SYST:PASS:CEN '894129'

Manual operation: See "Password" on page 141

SYSTem:PASSword:RESet

Clears any previously provided password and returns to the most restrictive service level.

Manual operation: See "Password" on page 141

11.4 VNA Remote Control Basics

11.4.1 Block Data Format

Block data is a transmission format which is suitable for the transmission of large amounts of data. A command using a block data parameter with definite length has the following structure:

Example: HEADer:HEADer #45168xxxxxxxx

The hash symbol # introduces the data block. The next number indicates how many of the following digits describe the length of the data block. In the example the 4 following digits indicate the length to be 5168 bytes. The data bytes follow. During the transmission of these data bytes all End or other control signs are ignored until all bytes are transmitted.

A #0 combination introduces a data block of indefinite length. The use of the indefinite format requires a NL^END message to terminate the data block. This format is useful when the length of the transmission is not known or if speed or other considerations prevent segmentation of the data into blocks of definite length.

11.4.2 Basic Remote Control Concepts

The GUI and the remote control command set both aim at maximum operating convenience. In manual control this generally means that the control elements are easy to find and intuitive to handle, and that the effect of each operation is easy to verify on the screen. Convenient remote control operation depends on a simple and systematic program syntax and on a predictable instrument state; the display of results is secondary.

These differences suggest the peculiarities in the analyzer's remote control concept discussed in the following sections.

11.4.2.1 Traces, Channels, and Diagram Areas

Like in manual control, traces can be assigned to a channel and displayed in diagram areas (see section Traces, Channels and Diagram Areas in Chapter 3). There are two main differences between manual and remote control:

- A trace can be created without being displayed on the screen.
- A channel must not necessarily contain a trace. Channel and trace configurations are independent of each other.

The following frequently used commands create and delete traces, channels, and diagram areas:

Create new trace and new channel (if channel <Ch> does not exist yet)	CALCulate<Ch>:PARAmeter:SDEFine '<Trace Name>', '< Meas Parameter>
Delete trace	CALCulate<Ch>:PARAmeter:DELEte '<Trace Name>'
Create or delete channel	CONFigure:CHANnel<Ch>[:STATE] ON OFF
Create or delete diagram area	DISPlay:WINDow<Wnd>:STATe ON OFF
Display trace in diagram area	DISPlay:WINDow<Wnd>:TRACe<WndTr>:FEED

The assignment between traces, channels, and diagram areas is defined via numeric suffixes as illustrated in the following example:

Example:

```
CALC4:PAR:SDEF 'Ch4Tr1', 'S11'
```

Create channel 4 (channel suffix 4) and a trace named "Ch4Tr1" to measure the input reflection coefficient S11. The trace is created but not displayed.

```
DISP:WIND2:STAT ON
```

Create diagram area no. 2 (window suffix 2).

```
DISP:WIND2:TRAC9:FEED 'CH4TR1'
```

Display the generated trace (identified by its name "Ch4Tr1") in diagram area no. 2 (window suffix 2), assigning the trace number 9 (trace suffix 9) to it.

11.4.2.2 Active Traces in Remote Control

In manual control there is always exactly one active trace, irrespective of the number of channels and traces defined. The "active channel" contains the active trace; see [Chapter 9.1.3.1, "Trace Settings"](#), on page 188.

In remote control, each channel contains an active trace (unless the channel contains no trace at all). This principle actually simplifies the remote control command syntax, because it allows the active trace in a particular channel to be referenced by means of

the channel suffix. No additional trace identifier is needed; there is no need either to distinguish channel and trace settings using mnemonics or suffixes.

The active traces are handled as follows:

- After a preset (*RST), the analyzer displays a single diagram area with the default trace no. 1 named Trc1. The trace is active in manual and in remote control.
- In manual control, a new, added trace automatically becomes the active trace. To select another trace as the active trace, tap inside the trace list.
- In remote control, a new trace added via CALCulate<Ch>:PARAmeter:SDEFine '<trace_name>', '<parameter>' also becomes the active trace. To select another trace as the active trace, use (CALCulate<Ch>:PARAmeter:SElect '<trace_name>').
- The active traces for manual and remote control may be different.

Example:

```
*RST
```

Reset the analyzer, creating channel no. 1 with the default trace "Trc1". The trace is displayed in diagram area no. 1.

```
CALC1:PAR:SDEF 'Trc2', 'S11'; DISP:WIND:TRAC2:FEED 'Trc2'
```

Create a new trace named "Trc2", assigned to channel no. 1 (the suffix 1 after CALC, may be omitted), and display the trace. The new trace automatically becomes the active trace for manual and for remote control. To check this, tap "Trace – Marker – Marker 1" to create a marker. The marker is assigned to "Trc2". Delete all markers ("Trace – Marker – All Markers Off").

```
CALC1:MARK ON
```

Example:

To verify that "Trc2" is also active for remote control, use the channel suffix 1 after CALC (may be omitted) to reference the active trace in channel 1 and create a marker "Mkr 1". The marker is assigned to "Trc2".

Example:

```
CALC:PAR:SEL 'Trc1'; CALC1:MARK ON
```

Select the old default trace "Trc1" as the active trace for remote control. Create a new marker to verify that "Trc1" is now the active trace in channel 1.



In the SCPI command description, the numeric suffix <Ch> is used for channel settings (it denotes the configured channel), whereas <Chn> is used for trace settings (it refers to the active trace in the channel).

11.4.2.3 Initiating Measurements, Speed Considerations

After a reset the network analyzer measures in continuous mode. The displayed trace shows the result of the last sweep and is continuously updated. This provides a permanent visual control over the measurement and the effect of any analyzer settings.

In remote control, it is advisable to follow a different approach in order use the analyzer's resources to full capacity and gain measurement speed. The following principles can help to optimize a remote control program (see also programming example in [Chapter 11.6.1.1, "Typical Stages of a Remote Control Program"](#), on page 958):

- Switch off the measurement while configuring your instrument.
- Use a minimum number of suitably positioned sweep points.
- Start a single sweep, observing proper command synchronization, and retrieve your results.

The following command sequence performs a single sweep in a single channel.

Example:

```
*RST; :INITiate:CONTInuous:ALL OFF
```

Activate single sweep mode for all channels (including the channels created later).

```
INITiate1:IMMediate; *WAI
```

Start a single sweep in channel no. 1, wait until the sweep is terminated before proceeding to the next command.



Sweeps in several channels

It is also possible to subdivide the channels within a channel setup into active and inactive channels. The analyzer will then measure in the subset of active channels only; see program example for [CONFigure:CHANnel<Ch>:MEASure\[:STATe\]](#).

11.4.2.4 Addressing Traces and Channels

The analyzer provides a variety of schemes for addressing traces and channels and for querying trace and channel names. The following tables give an overview.

Table 11-2: Addressing channels

Method	Commands / Example
Channel number <Ch> as a numeric suffix	CONFigure:CHANnel<Ch>[:STATe] ON
Query all channel names	CONFigure:CHANnel:CATalog? (returns the names of all channels)
Assign or query channel name of a channel numbered <Ch>	CONFigure:CHANnel<Ch>:NAME 'ABCD' CONFigure:CHANnel<Ch>:NAME? (returns 'ABCD')
Query channel number assigned to a channel named 'ABCD'	CONFigure:CHANnel<Ch>:NAME:ID? 'ABCD' (returns the actual channel number, the channel suffix is ignored)

Table 11-3: Addressing traces

Method	Commands / Example
Channel number <Chn> used as a reference for the active trace in the channel	CALCulate<Chn>:MARKer<Mk>[:STATe] ON
Trace name (string variable) used as a reference for the trace	CALCulate<Ch>:PARAMeter:DELeTe '<Trace Name>'
Trace number <Trc> as a numeric suffix (exception!)	CONFigure:TRACe<Trc>:NAME?
Trace number <WndTr> within a particular diagram area <Wnd>	DISPlay:WINDow<Wnd>:TRACe<WndTr>:FEED
Query all trace names	CONFigure:TRACe:CATalog? (returns the names of all traces)
Assign or query trace name of a trace numbered <Trc>	CONFigure:TRACe<Trc>:NAME 'ABCD' CONFigure:TRACe<Trc>:NAME? (returns 'ABCD')
Query trace number assigned to a trace named 'ABCD'	CONFigure:TRACe<Trc>:NAME:ID? 'ABCD' (returns the actual trace number; the trace suffix is ignored)

Table 11-4: Mixed commands

Method	Commands / Example
Query channel name for a trace referenced by its trace name	CONFigure:TRACe<Trc>:CHANnel:NAME? 'ABCD' (returns the channel name for trace 'ABCD'; the trace suffix is ignored)
Query channel number for a trace referenced by its trace name	CONFigure:TRACe<Trc>:CHANnel:NAME:ID? 'ABCD' (returns the actual channel number for trace 'ABCD'; the trace suffix is ignored)

11.4.3 The IECWIN Tool

The R&S ZNL/ZNLE is delivered with *IECWIN* installed, an auxiliary tool provided free of charge by R&S. IECWIN is a program to send SCPI commands to a measuring instrument either interactively or from a command script.



The R&S IECWIN32 tool is provided free of charge. The functionality may change in a future version without notice.

IECWIN offers the following features:

- Connection to instrument via several interfaces/protocols (GPIB, VISA, named pipe (if IECWIN is run on the instrument itself), RSIB)
- Interactive command entry
- Browsing available commands on the instrument
- Error checking following every command
- Execution of command scripts
- Storing binary data to a file

- Reading binary data from a file
- Generation of a log file

For command scripts, IECWIN offers the following features:

- Synchronization with the instrument on every command
- Checking expected result for query commands (as string or numeric value)
- Checking for expected errors codes
- Optional pause on error
- Nested command scripts
- Single step mode
- Conditional execution, based on the *IDN and *OPT strings



You can use the IECWIN to try out the programming examples provided in the R&S ZNL/ZNLE User Manuals.

Starting IECWIN

IECWIN is available from the Windows "Start" menu on the R&S ZNL/ZNLE, or by executing the following file:

```
C:\Program Files\Rohde-Schwarz\Vector Network Analyzer\ZNL\
iecw32.exe
```

You can also copy the program to any Windows PC or laptop. Simply copy the `iecw32.exe`, `iecw32.chm` and `rsib32.dll` files from the location above to the same folder on the target computer.

When the tool is started, a "Connection settings" dialog box is displayed. Define the connection from the computer the IECWIN tool is installed on to the R&S ZNL/ZNLE you want to control. If you are using the tool directly on the R&S ZNL/ZNLE, you can use an NT Pipe (COM Parser) connection, which requires no further configuration. For help on setting up other connection types, check the tool's online help (by clicking the "Help" button in the dialog box).



The IECWIN offers an online help with extensive information on how to work with the tool.

11.4.4 Status Reporting System

The status reporting system stores all information on the present operating state of the instrument, and on errors which have occurred. This information is stored in the status registers and in the error queue. Both can be queried using the `STATUS...` commands.

Hierarchy of status registers

As shown in section [Overview of Status Registers](#), the status information is of hierarchical structure.

- **STB, SRE:**
The S**T**atus **B**yte (STB) register and its associated mask register **S**ervice **R**quest **E**nable (SRE) make up the highest level of the status reporting system. The STB provides a rough overview of the instrument status, collecting the information of the lower-level registers.
- The STB receives its information from:
The **E**vent **S**tatus **R**egister (ESR) with the associated mask register **s**tandard **E**vent **S**tatus **E**nable (ESE).
The **S**TATUS:OPERation and **S**TATUS:QUEStionable registers which are defined by SCPI and contain detailed information on the instrument.
- **IST, PPE:**
The **I**ndividual **S**Tatus (IST) flag, like the SRQ, combines the entire instrument status in a single bit. The **P**PE is associated to the IST flag. It fulfills an analogous function for the IST flag as the SRE does for the service request.
- **Output buffer:**
contains the messages the instrument returns to the controller. It is not part of the status reporting system but determines the value of the MAV bit in the STB.

All status registers have the same internal structure, see [Structure of a SCPI Status Register](#).

For more information on the individual status registers, see [Contents of the Status Registers](#).



SRE register

The service request enable register SRE can be used as **ENABLE** part of the STB if the STB is structured according to SCPI. By analogy, the ESE can be used as the **ENABLE** part of the ESR.

11.4.4.1 Overview of Status Registers

The status registers of the R&S ZNL/ZNLE are implemented as shown below.

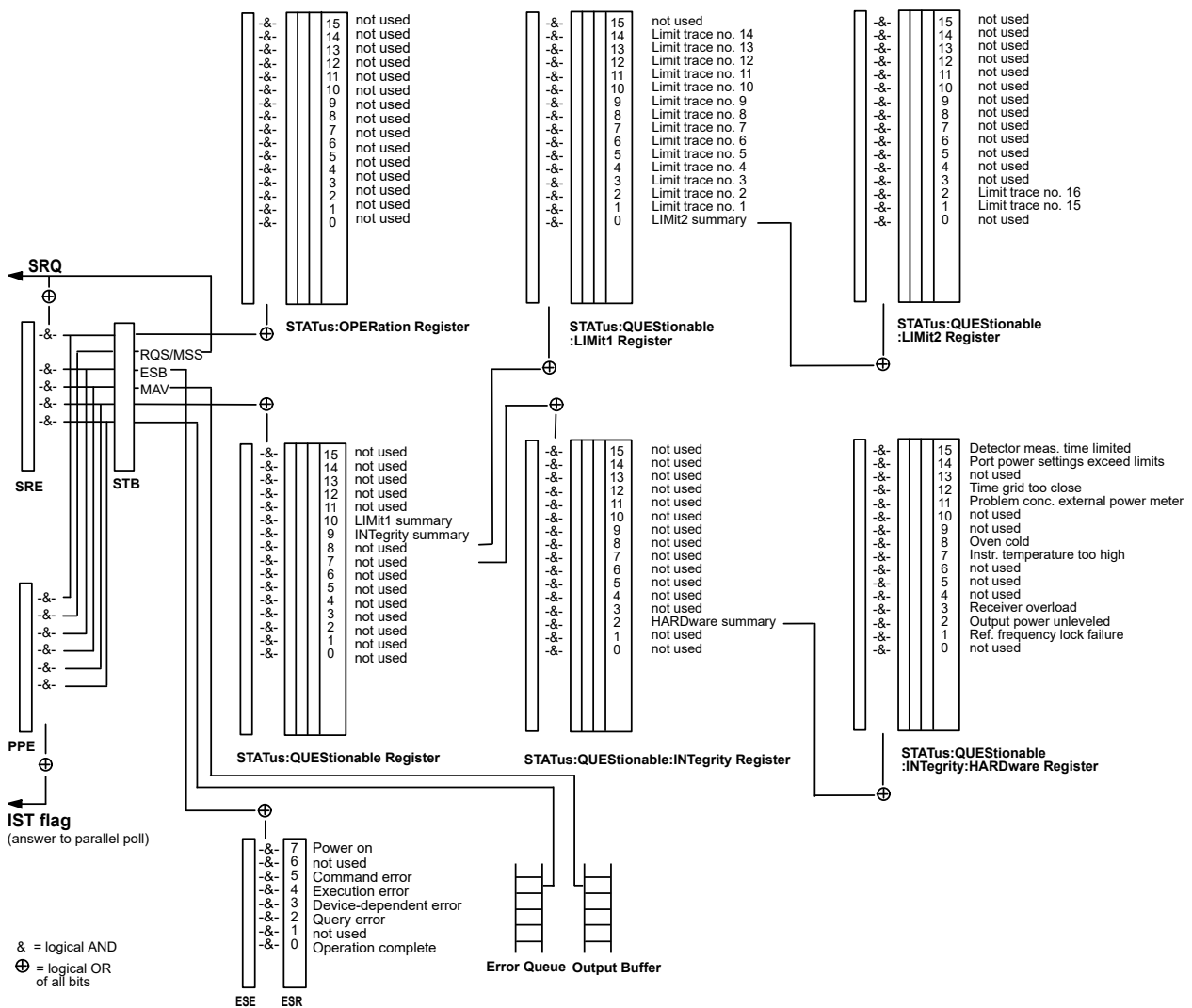

11.4.4.2 Structure of a SCPI Status Register

Each standard SCPI register consists of 5 parts which each have a width of 16 bits and have different functions. The individual bits are independent of each other, i.e. each hardware status is assigned a bit number which is valid for all five parts. Bit 15 (the most significant bit) is set to zero for all parts. Thus the contents of the register parts can be processed by the controller as positive integer.

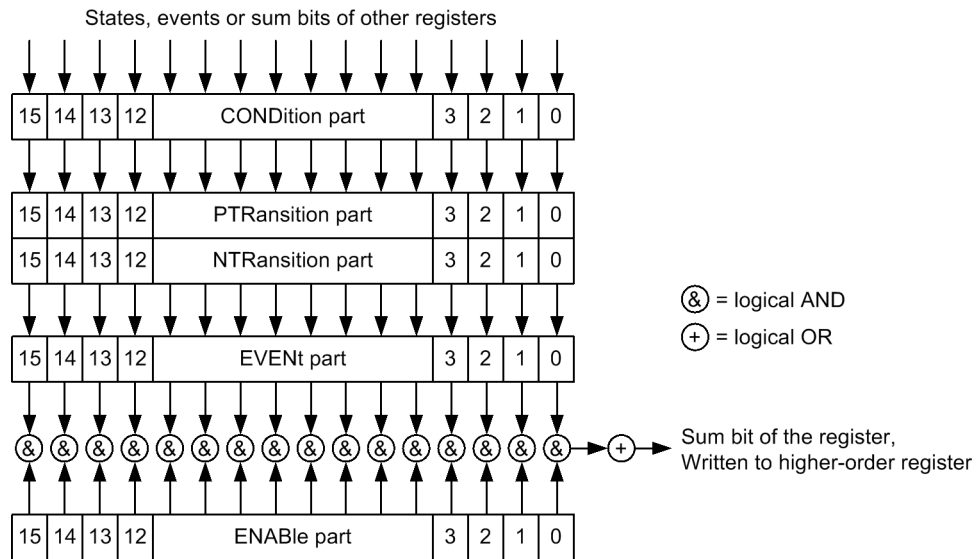

The sum bit is obtained from the EVENT and ENABLE part for each register. The result is then entered into a bit of the CONDition part of the higher-order register.

The instrument automatically generates the sum bit for each register. Thus an event can lead to a [Service Request](#) throughout all levels of the hierarchy.

The five parts of a SCPI register have different properties and function as described below.

CONDition

The CONDition part is permanently overwritten by the hardware or the sum bit of the next lower register. Its contents always reflect the current instrument state.

This register part can only be read, but not overwritten or cleared. Reading the CONDition register is nondestructive.

PTRransition

The two transition register parts define which state transition of the condition part (none, 0 to 1, 1 to 0 or both) is stored in the EVENT part.

The Positive TRransition part acts as a transition filter. When a bit of the CONDition part is changed from 0 to 1, the associated PTR bit decides whether the EVENT bit is set to 1:

- PTR bit = 1: the EVENT bit is set
- PTR bit = 0: the EVENT bit is not set

This status register part can be overwritten and read at will. Reading the PTRransition register is nondestructive.

NTRansition

The Negative TRansition part also acts as a transition filter. When a bit of the CONDition part is changed from 1 to 0, the associated NTR bit decides whether the EVENT bit is set to 1.

- NTR bit = 1: the EVENT bit is set.
- NTR bit = 0: the EVENT bit is not set.

This part can be overwritten and read at will. Reading the PTRansition register is non-destructive.

EVENT

The EVENT part indicates whether an event has occurred since the last reading, it is the "memory" of the condition part. It only indicates events passed on by the transition filters. It is permanently updated by the instrument. This part can only be read by the user. Reading the register clears it. This part is often equated with the entire register.

ENABLE

The ENABLE part determines whether the associated EVENT bit contributes to the sum bit (cf. below). Each bit of the EVENT part is ANDed with the associated ENABLE bit (symbol '&'). The results of all logical operations of this part are passed on to the sum bit via an OR function (symbol '+').

- ENAB bit = 0: The associated EVENT bit does not contribute to the sum bit.
- ENAB bit = 1: If the associated EVENT bit is "1", the sum bit is set to "1" as well.

This part can be overwritten and read by the user at will. Its contents are not affected by reading.

The **sum bit** is obtained from the EVENT and ENABLE part for each register. The result is then entered into a bit of the CONDition part of the higher-order register. The instrument automatically generates the sum bit for each register. Thus an event can lead to a service request throughout all levels of the hierarchy.

11.4.4.3 Contents of the Status Registers

The individual status registers are used to report different classes of instrument states or errors. The following status registers belong to the general model described in IEEE 488.2:

- The SStatus Byte (STB) gives a rough overview of the instrument status.
- The Individual SStatus (IST) flag combines the entire status information into a single bit that can be queried in a [Parallel Poll](#).
- The Event Status Register (ESR) indicates general instrument states.

The status registers below belong to the device-dependent SCPI register model:

- The STATus:OPERation register contains conditions which are part of the instrument's normal operation.
- The STATus:QUESTionable register indicates whether the data currently being acquired is of questionable quality.

- The `STATUS:QUESTIONABLE:LIMIT<1|2>` register indicates the result of the limit check.
- The `STATUS:QUESTIONABLE:INTEGRITY` register monitors hardware failures of the analyzer.

STB and SRE

The Status Byte (STB) provides a rough overview of the instrument status by collecting the pieces of information of the lower registers. The STB represents the highest level within the SCPI hierarchy. A special feature is that bit 6 acts as the summary bit of the remaining bits of the status byte.

The STB is linked to the Service Request Enable (SRE) register on a bit-by-bit basis.

- The STB corresponds to the `EVENT` part of a SCPI register, indicating the current instrument state. This register is cleared when it is read.
- The SRE corresponds to the `ENABLE` part of a SCPI register. If a bit is set in the SRE and the associated bit in the STB changes from 0 to 1, a [Service Request](#) (SRQ) is generated. Bit 6 of the SRE is ignored, because it corresponds to the summary bit of the STB.

The bits in the STB are defined as follows:

Bit No.	Meaning
2	<p>Error queue not empty</p> <p>If this bit is enabled by the SRE, each entry of the error queue generates a Service Request (SRQ). Thus an error can be recognized and further pinned down by polling the error queue. The poll provides an informative error message.</p>
3	<p>QUESTIONABLE status summary bit</p> <p>This bit is set if an <code>EVENT</code> bit is set in the <code>STATUS:QUESTIONABLE</code> register and the associated <code>ENABLE</code> bit is set to 1.</p> <p>The bit indicates a questionable instrument status, which can be further pinned down by polling the <code>QUESTIONABLE</code> register.</p>
4	<p>MAV bit (message available)</p> <p>This bit is set if a message is available and can be read from the output buffer.</p> <p>This bit can be used to transfer data from the instrument to the controller automatically.</p>
5	<p>ESB bit</p> <p>Sum bit of the event status register. It is set if one of the bits in the event status register is set and enabled in the event status enable register.</p> <p>Setting of this bit implies an error or an event which can be further pinned down by polling the event status register.</p>
6	<p>MSS bit (master status summary bit)</p> <p>This bit is set if the instrument triggers a service request, which happens if one of the other bits of this register is set together with its mask bit in the SRE register.</p>
7	<p>OPERATION status register summary bit</p> <p>This bit is set if an <code>EVENT</code> bit is set in the <code>OPERATION</code> status register and the associated <code>ENABLE</code> bit is set to 1.</p> <p>The bit indicates that the instrument is performing an action. The type of action can be determined by polling the <code>STATUS:OPERATION</code> register.</p>

Related common commands

The STB is read out using the command `*STB?` or a [Serial Poll](#).

The SRE can be set using command `*SRE` and read using `*SRE?`.

IST Flag and PPE

In analogy to the [Service Request](#) (SRQ), the Individual Status (IST) flag combines the entire status information in a single bit. It can be queried by a [Parallel Poll](#).

The Parallel Poll Enable (PPE) register determines which bits of the STB contribute to the IST flag. The bits of the STB are ANDed with the corresponding bits of the PPE, with bit 6 being used as well in contrast to the SRE. The IST flag results from ORing all results.

Related common commands

The IST flag is queried using the common command `*IST?`. The PPE can be set using `*PRE` and read using `*PRE?`.

See also [Common Commands](#)

ESR and ESE

The Event Status Register (ESR) indicates general instrument states. It is linked to the Event Status Enable (ESE) register on a bit-by-bit basis.

- The ESR corresponds to the CONDition part of a SCPI register indicating the current instrument state (although reading is destructive).
- The ESE corresponds to the ENABLE part of a SCPI register. If a bit is set in the ESE and the associated bit in the ESR changes from 0 to 1, the ESB bit in the Status Byte (STB) is set.

The bits in the ESR are defined as follows:

Bit No.	Meaning
0	<p>Operation complete</p> <p>This bit is set on receipt of the command <code>*OPC</code> after all previous commands have been executed.</p>
2	<p>Query error</p> <p>This bit is set if either the controller wants to read data from the instrument without having sent a query, or if it does not fetch requested data and sends new instructions to the instrument instead. The cause is often a query which is faulty and hence cannot be executed.</p>
3	<p>Device-dependent error</p> <p>This bit is set if a device-dependent error occurs. An error message with a number between -300 and -399 or a positive error number, which describes the error in greater detail, is entered into the error queue. See also Chapter 12.1, "Error Messages and Troubleshooting", on page 1003.</p>
4	<p>Execution error</p> <p>This bit is set if a received command is syntactically correct, but cannot be performed for other reasons. An error message with a number between -200 and -300, which describes the error in greater detail, is entered into the error queue.</p>

Bit No.	Meaning
5	Command error This bit is set if a command which is undefined or syntactically incorrect is received. An error message with a number between -100 and -200, which describes the error in greater detail, is entered into the error queue.
7	Power On (supply voltage on) This bit is set when the instrument is switched on.

Related common commands

The Event Status Register (ESR) can be queried using `ESR?`. The Event Status Enable (ESE) register can be set using the command `*ESE` and read using `*ESE?`.

See also [Common Commands](#)

STATus:OPERation

The STATus:OPERation register contains conditions which are part of the instrument's normal operation. The analyzer does not use the STATus:OPERation register.

STATus:QUEStionable

The STATus:QUEStionable register indicates whether the acquired data is of questionable quality and monitors hardware failures of the analyzer. It can be queried using the commands `STATus:QUEStionable:CONDition?` or `STATus:QUEStionable:EVENT?`.

Bit No.	Meaning
9	INTEGRity register summary This bit is set if a bit is set in the STATus:QUEStionable:INTEGRity register and the associated ENABLE bit is set to 1.
10	LIMit register summary This bit is set if a bit is set in the STATus:QUEStionable:LIMit1 register and the associated ENABLE bit is set to 1.

STATus:QUEStionable:LIMit<1|2>

The STATus:QUEStionable:LIMit<1|2> registers indicate the result of the limit check. They can be queried using the commands `STATus:QUEStionable:LIMit<1|2>:CONDition?` or `STATus:QUEStionable:LIMit<1|2>[:EVENT]?`
`STATus:QUEStionable:LIMit1` is also the summary register of the lower level `STATus:QUEStionable:LIMit2` register.

The bits in the STATus:QUEStionable:LIMit1 register are defined as follows:

Bit No.	Meaning
0	LIMit2 register summary This bit is set if a bit is set in the STATus:QUEStionable:LIMit2 register and the associated ENABle bit is set to 1.
1	Failed limit check for trace no. 1 This bit is set if any point on trace no. 1 fails the limit check.
...	...
14	Failed limit check for trace no. 14 This bit is set if any point on trace no. 14 fails the limit check.

The bits in the STATus:QUEStionable:LIMit2 register are defined as follows:

Bit No.	Meaning
0	Not used
1	Failed limit check for trace no. 15 This bit is set if any point on trace no. 15 fails the limit check.
2	Failed limit check for trace no. 16 This bit is set if any point on trace no. 16 fails the limit check.

Numbering of traces

The traces numbers 1 to 16 are assigned as follows:

- Traces assigned to channels with smaller channel numbers have smaller trace numbers.
- Within a channel, the order of traces reflects their creation time: The oldest trace has the smallest, the newest trace has the largest trace number. This is equivalent to the order of traces in the response string of the `CALCulate<Ch>:PARAmeter:CATalog? query`.
- The number of traces monitored cannot exceed 16. If a setup contains more traces, the newest traces are not monitored.

STATus:QUEStionable:INTegrity...

The STATus:QUEStionable:INTegrity register monitors hardware failures of the analyzer. It can be queried using the commands

```
STATus:QUEStionable:INTegrity:CONDition? or
STATus:QUEStionable:INTegrity[:EVENT]?
```

STATus:QUEStionable:INTegrity is also the summary register of the lower level STATus:QUEStionable:INTegrity:HARDware register.



Refer to the [Chapter 12.1, "Error Messages and Troubleshooting"](#), on page 1003 for a detailed description of hardware errors including possible remedies.

The bits in the STATus:QUEStionable:INTegrity register are defined as follows.

Bit No.	Meaning
2	<p>HARDware register summary</p> <p>This bit is set if a bit is set in the STATUS:QUESTIONable:INTEgrity:HARDware register and the associated ENABLE bit is set to 1.</p>

STATUS:QUESTIONable:INTEgrity:HARDware

The STATUS:QUESTIONable:INTEgrity:HARDware register can be queried using the commands STATUS:QUESTIONable:INTEgrity:HARDware:CONDition? or STATUS:QUESTIONable:INTEgrity:HARDware[:EVENT]?

The bits in the STATUS:QUESTIONable:INTEgrity:HARDware register are defined as follows.

Bit No.	Meaning
0	Not used
1	<p>Reference frequency lock failure</p> <p>If an external reference signal or an internal high precision clock (option B4) is used, the local oscillator is phase locked to a reference signal. This bit is set if this phase locked loop (PLL) fails.</p> <p>For external reference: check frequency and level of the supplied reference signal.</p>
2	<p>Output power unlevelled</p> <p>This bit is set if the level control at one of the ports is unsettled or unstable, possibly due to an external disturbing signal.</p> <p>Change generator level at the port; check external components.</p>
3	<p>Receiver overload protection tripped</p> <p>This bit is set if the analyzer detects an excessive input level at one of the ports. If this condition persists, all internal sources are switched off.</p> <p>Reduce RF input level at the port. Check amplifiers in the external test setup, then switch on the internal source using OUTPUT ON.</p>
6	<p>Internal communication error</p> <p>This bit is set if an internal error caused the analyzer to perform an automatic hardware reset. The current measurement results are possibly invalid.</p> <p>The bit is automatically cleared at the beginning of the next sweep, no action is required.</p>
7	<p>Instrument temperature is too high</p> <p>This bit is set if the analyzer detects that the instrument temperature is too high.</p> <p>Reduce ambient temperature, keep ventilation holes of the casing unobstructed.</p>
8	<p>Oven cold</p> <p>This bit is set if the oven for the internal high precision clock (option B4) is not at its operating temperature.</p> <p>Wait until the oven has been heated up.</p>
9	<p>Unstable level control</p> <p>This bit is set if the analyzer detects an excessive source level at one of the ports. The signal is turned off and the sweep halted.</p> <p>Check signal path for the received wave, especially check external components. Then restart the sweep (INITiate<Ch>[:IMMediate]).</p>

Bit No.	Meaning
11	<p>Problem concerning external power meter</p> <p>This bit is set if an external power meter has been configured but cannot be controlled or provides error messages.</p> <p>Check whether the power meter is properly connected and switched on. Check the GPIB address; exclude address conflicts when using several external power meters or other equipment.</p>
12	<p>Time grid too close</p> <p>This bit is set if the sweep points for a time sweep are too close, so that the analyzer cannot process the measurement data until the next sweep point starts.</p> <p>Increase stop time, reduce no. of points, increase IF bandwidth. If possible reduce number of partial measurements, e.g. by restricting the number of ports measured.</p>
14	<p>Power settings exceed hardware limits</p> <p>This bit is set if the source power at one of the test ports is too high or too low.</p> <p>Reduce or increase the source power.</p>
15	<p>Detector MEAS time has been internally limited</p> <p>This bit is set if the selected measurement time for a detector (observation time) is too long.</p> <p>If desired, reduce the measurement time or select a smaller IF bandwidth.</p>

11.4.4.4 Application of the Status Reporting System

The purpose of the status reporting system is to monitor the status of one or several devices in a measuring system. To do this and react appropriately, the controller must receive and evaluate the information of all devices. The following standard methods described in the following sections are used:

- Service request (SRQ) initiated by the measuring device
- Serial poll of all devices in the bus system, initiated by the controller to find out who sent an SRQ and why
- Parallel poll of all devices
- Query of a specific instrument status by commands
- Query of the error queue

Service Request

The R&S ZNL/ZNLE can send a service request (SRQ) to the controller. Usually this service request causes an interrupt, to which the control program can react appropriately.

Initiating an SRQ

As shown in section [Overview of Status Registers](#), an SRQ is initiated if one or several of bits 2, 3, 4, 5 or 7 of the status byte are set and enabled in the SRE. Each of these bits summarizes the information of a further register, the error queue or the output buffer.

The ENABLE parts of the status registers can be set such that arbitrary bits in an arbitrary status register initiate an SRQ. To use the possibilities of the service request effectively, all bits in the enable registers SRE and ESE must be set to "1".

Example: Use *OPC to generate an SRQ

1. Set bit 0 in the ESE (Operation Complete).
2. Set bit 5 in the SRE (ESB).
3. Insert *OPC in the command sequence (e.g. at the end of a sweep).

When all commands preceding *OPC have been completed, the instrument generates an SRQ.

Example: Generate an SRQ when a limit is exceeded

1. Set bit 3 in the SRE (summary bit of the STATUS:QUESTIONABLE register, set after STATUS:PRESet)
2. Set bit 10 in the STATUS:QUESTIONABLE:ENABLE register (summary bit of the STATUS:QUESTIONABLE:LIMIT1 register)
3. Set bit 1 in the STATUS:QUESTIONABLE:LIMIT1:ENABLE register

The R&S ZNL/ZNLE generates an SRQ when the event associated with bit 1 of the STATUS:QUESTIONABLE:LIMIT1:ENABLE register occurs, i.e. when any point on the first trace fails the limit check.

Example: Find out which event caused an SRQ

The procedure to find out which event caused an SRQ is analogous the procedure to generate an SRQ:

1. STB? (query the contents of the status byte in decimal form)
If bit 3 (QUESTIONABLE summary bit) is set, then:
2. STAT:QUES:EVENT? (query STATUS:QUESTIONABLE register)
If bit 10 (QUESTIONABLE:LIMIT1 summary bit) is set, then:
3. Query STAT:QUES:LIMIT1:EVENT? (query STATUS:QUESTIONABLE:LIMIT1 register)
If bit 1 is set, then the first trace failed the limit check.



The SRQ is the only possibility for the instrument to become active on its own. Each controller program should set the instrument such that a service request is initiated in the case of malfunction. The program should react appropriately to the service request.

Serial Poll

In a serial poll, the controller queries the S`T`atus Bytes of the devices in the bus system one after another. The query is made via interface messages, so it is faster than a poll using `*STB?`.

The serial poll method is defined in IEEE 488.1 and used to be the only standard possibility for different instruments to poll the status byte. The method also works for instruments which do not adhere to SCPI or IEEE 488.2.

The serial poll is used to obtain a fast overview of the state of several instruments connected to the controller.

Parallel Poll

In a parallel poll, up to eight instruments are simultaneously requested by the controller with a single command to transmit 1 bit of information each on the data lines, i.e., to set the data line allocated to each instrument to a logical "0" or "1".

In addition to the S`R`E register, which determines the conditions under which an S`R`Q is generated, there is a Parallel Poll Enable (PPE) register. This register is ANDed with the S`T`B bit by bit, considering bit 6 as well. The results are O`R`ed, the result is possibly inverted and then sent as a response to the parallel poll of the controller. The result can also be queried without parallel poll with the command `*IST?`.

The parallel poll method is used to find out quickly which one of the instruments connected to the controller has sent a service request. To this effect, S`R`E and PPE must be set to the same value.

Query of an Instrument Status

Each part of any status register can be read using queries. There are two types of commands:

- The common commands `*ESR?`, `*IDN?`, `*IST?`, `*STB?` query the higher-level registers.
- The commands of the S`T`A`T`us system query the SCPI registers (e.g. `STATus:OPERation...`)

All queries return a decimal number which represents the bit pattern of the status register. This number is evaluated by the controller program.

Queries are usually used after an S`R`Q to obtain more detailed information on its cause.

Decimal representation of a bit pattern

The S`T`B and E`S`R registers contain 8 bits, the S`C`P`I` registers 16 bits. The contents of a status register is keyed and transferred as a single decimal number. To make this possible, each bit is assigned a weighted value. The decimal number is calculated as the sum of the weighted values of all bits in the register that are set to 1.

Bits	0	1	2	3	4	5	6	7	...
Weight	1	2	4	8	16	32	64	128	...

Example: The decimal value 40 = 32 + 8 indicates that bits no. 3 and 5 in the status register (e.g. the QUEStionable status summary bit and the ESB bit in the STB) are set.

Error Queue

Each error state in the instrument leads to an entry in the error queue. The entries of the error queue are detailed plain text error messages that can be queried via remote control using `SYSTem:ERRor[:NEXT]?`. Each call of `SYSTem:ERRor[:NEXT]?` provides one entry from the error queue. If no error messages are stored there any more, the instrument responds with 0, "No error".

The error queue should be queried after every SRQ in the controller program as the entries describe the cause of an error more precisely than the status registers. Especially in the test phase of a controller program the error queue should be queried regularly since faulty commands from the controller to the instrument are recorded there as well.

11.4.4.5 Reset Values of the Status Reporting System

The table below indicates the effects of various commands upon the status reporting system of the R&S ZNL/ZNLE.

DCL, SDC (Device Clear, Selected Device Clear)

Event	Switching on supply voltage Power-On-Status-Clear		DCL, SDC (Device Clear, Selected Device Clear)	*RST or SYS-Tem:PRE-Set:ALL	STA-Tus:PRE-Set	*CLS
	0	1				
Effect	0	1				
Clear STB, ESR		yes				yes
Clear SRE, ESE		yes				
Clear PPE		yes				
Clear EVENT parts of the registers		yes				yes
Clear ENABLE parts of all OPERation and QUEStionable registers, Fill ENABLE parts of all other registers with "1".		yes			yes	
Fill PTRansition parts with "1" Clear NTRansition parts		yes			yes	
Clear error queue	yes	yes				yes
Clear output buffer	yes	yes	yes	1)	1)	1)
Clear command processing and input buffer	yes	yes	yes			

- 1) Every command being the first in a command line, i.e. immediately following a <PROGRAM MESSAGE TERMINATOR> clears the output buffer.

11.5 VNA Command Reference

This chapter describes the SCPI commands implemented by the VNA mode of the R&S ZNL/ZNLE.

Compatibility with R&S ZVB and older instruments

The SCPI command set for the R&S ZNL/ZNLE vector network analyzer has been designed for compatibility with network analyzers R&S ZVA and R&S ZVB. A special subset of commands has been implemented for compatibility with older analyzers of the R&S ZVR family. These commands are listed in [Chapter 11.5.3, "R&S ZVR/ZVABT Compatible Commands"](#), on page 935.

If you want to make full use of the R&S ZNL/ZNLE features but do not need R&S ZVR compatibility, you should use the commands listed in [Chapter 11.5.2, "SCPI Command Reference"](#), on page 597.

11.5.1 Special Terms and Notation

This section explains the meaning of special syntax elements used in the SCPI command reference sections.

The following information is provided in the reference sections:

- Complete command syntax and parameter list
- Description of the command and its relationship with other commands
- List and description of the parameters with their numerical ranges, default values and default units
- Supported command types (setting command, query). If nothing is mentioned, the command can be used to write **and** read data (setting command and query).
- Program example

The SCPI conformance information is stated at the beginning of each section. Unless otherwise stated, the commands are device-specific.

The commands are generally arranged in alphabetical order. Commands with similar function (e.g. a pair of `...START` and `...STOP` commands) may be described in a common section, which in some instances disrupts the strict alphabetical order.

11.5.1.1 Upper/Lower Case

Upper/lower case characters characterize the long and short form of the mnemonics in a command. The short form consists of all upper-case characters, the long form of all upper case plus all lower case characters. It is recommended to use either the short

form or the long form; mixed forms are not always recognized. The R&S ZNL/ZNLE itself does not distinguish upper case and lower case characters.

11.5.1.2 Special Characters

The following special characters are frequently used in the command description:

- **|** A vertical stroke characterizes alternative parameter settings. Only one of the parameters separated by | must be selected.
- **[]** Mnemonics in square brackets can be omitted when composing the command header. The complete command must be recognized by the instrument for reasons of compatibility with the SCPI standard. Parameters in square brackets are optional as well. They may be used in some application contexts, omitted in others.
- **{ }** Braces or curly brackets enclose one or more parameters that may be included zero or more times.

11.5.1.3 Parameters

Many commands are supplemented by a parameter or a list of parameters. Parameters either provide alternative options (setting a or setting b or setting c ..., see special character "|"), or they form a list separated by commas (setting x, y).

- **<Parameter1>, <Parameter2>...:** In the command tables and lists, parameters are generally described by a name (Parameter1, Parameter2...) written in angle brackets (<>). In an application program, <Parameter1>, <Parameter2>... must be replaced by one of the possible settings reported in the detailed parameter description.

Example: `CONTRol:AUXiliary:C[:DATA] <DecValue>`

with <DecValue> = 0 to 255

--> possible command syntax: `CONTRol:AUXiliary:C:DATA 1`

- **NAN (Not A Number)** (as a returned value) is generally used to represent missing data, e.g. if a portion of a trace has not been acquired yet. It is also returned after invalid mathematical operations such as division by zero. As defined in the SCPI standard, NAN is represented as 9.91 E 37.
- **INV (INValid)** is returned e.g. if a limit check is performed without defining the appropriate tolerance values.

11.5.1.4 Numeric Suffixes

Symbols in angular brackets (<Ch>, <Chn>, <Mk>...) are numeric suffixes. Numeric suffixes are replaced by integer numbers to distinguish various items of the same type. The analyzer provides numeric suffixes for channels, traces, ports, markers etc. If unspecified, a numeric suffix is replaced by 1.

The marker suffix must be in the range between 1 and 10, the number of ports depends on the analyzer model. No restrictions apply to channel, trace, and diagram suffixes.

In remote control, one active trace can be selected for each channel; see [Chapter 11.4.2.2, "Active Traces in Remote Control"](#), on page 577. This concept simplifies

the remote control command syntax, because it allows the active trace in a particular channel to be referenced by means of the channel suffix. To keep the syntax transparent, <Ch> is used for channel settings (it denotes the configured channel), whereas <Chn> is used for trace settings (it denotes the active trace in the channel).

11.5.2 SCPI Command Reference

The following sections provide detailed reference information on the instrument control commands implemented by the R&S ZNL/ZNLE network analyzer.

• CALCulate Commands	597
• CONFigure Commands	747
• CONTRol Commands	755
• DIAGnostic Commands	756
• DISPlay Commands	757
• FORMat Commands	778
• INITiate Commands	779
• INSTrument Commands	782
• LAYOut	782
• MMEMory Commands	783
• OUTPut Commands	810
• PROGram Commands	814
• [SENSe:] Commands	818
• SOURce Commands	906
• STATus Commands	911
• SYSTem Commands	915
• TRACe Commands	927
• TRIGger Commands	930

11.5.2.1 CALCulate Commands

The `CALCulate...` commands perform post-acquisition data processing. Functions in the `SENSe` subsystem are related to data acquisition, while the `CALCulate` subsystem operates on the data acquired by a `SENSe` function.

CALCulate:CLIMits...

The `CALCulate:CLIMits...` commands control the composite limit check.

CALCulate:CLIMits:FAIL?

Returns a 0 or 1 to indicate whether or not a global, composite limit check on several traces has failed.

Since V2.20 of the R&S ZNL/ZNLE FW the result is automatically recalculated whenever a relevant setting is changed, i.e. a subsequent query will return the updated limit violation state.

- Example:** `*RST; CALC:LIM:CONT 1 GHZ, 2 GHZ`
 Define an upper limit line segment in the stimulus range between 1 GHz and 2 GHz, using default response values.
`CALC:LIM:STAT ON; FAIL?`
 Switch the limit check on and query the result.
`CALC:CLIM:FAIL?`
 Query the result for the composite limit check. As only one trace is tested, the response should be equal to the previous response.
- Usage:** Query only
- Manual operation:** See "Global Check" on page 414

CALCulate:DATA...

The `CALCulate:DATA...` commands provide access to the results of a measurement.



Data format

The trace data is transferred in either ASCII or block data (REAL) format, depending on the `FORMat[:DATA]` setting. If block data format is used, it is recommended to select EOI as a receive terminator (`SYSTem:COMMunicate:GPIB[:SELF]:RTERminator EOI`).

<code>CALCulate:DATA:ALL?</code>	598
<code>CALCulate:DATA:DALL?</code>	599
<code>CALCulate:DATA:TRACe</code>	599
<code>CALCulate<Ch>:DATA:CALL</code>	600
<code>CALCulate<Ch>:DATA:CALL:CATalog?</code>	601
<code>CALCulate<Ch>:DATA:CHANnel:ALL?</code>	601
<code>CALCulate<Ch>:DATA:CHANnel:DALL?</code>	601
<code>CALCulate<Ch>:DATA:MDATa:INTerpolate</code>	602
<code>CALCulate<Ch>:DATA:SGRoup?</code>	602
<code>CALCulate<Chn>:DATA</code>	602
<code>CALCulate<Chn>:DATA:NSWeep[:LAST]?</code>	605
<code>CALCulate<Chn>:DATA:NSWeep:COUNT?</code>	606
<code>CALCulate<Chn>:DATA:NSWeep:FIRSt?</code>	606
<code>CALCulate<Chn>:DATA:STIMulus?</code>	607

CALCulate:DATA:ALL? <Format>[, <ChannelSetup>]

Reads the current response values of all traces of the referenced channel setup.

Query parameters:

<Format> FDATa | SDATa | MDATa
 Output format for the S-parameter data, see
`CALCulate<Chn>:DATA`.

<ChannelSetup> Name of a VNA channel setup. Can be omitted if the active VNA channel setup shall be referenced.

Return values:

<Data> Response values either in ASCII or block data format, depending on the current `FORMat[:DATA]` setting.

Example: See `CALCulate<Chn>:DATA`

Usage: Query only

CALCulate:DATA:DALL? <Format>

Reads the current response values of all data traces of the current channel setup. Use `CALCulate:DATA:ALL?` to query data traces and memory traces.

Query parameters:

<Format> FDATa | SDATa | MDATa
Output format for the S-parameter data, see `CALCulate<Chn>:DATA`.

Return values:

<Data> Response values either in ASCII or block data format, depending on the current `FORMat[:DATA]` setting.

Example: Analogous to `CALCulate:DATA:DALL?`; see `CALCulate<Chn>:DATA`.

Usage: Query only

CALCulate:DATA:TRACe <TraceName>, <Format>, <Data>...

The query gets the trace data of an arbitrary (not necessarily the active) trace, referenced by its trace name <TraceName>.

The "set direction" allows to import formatted or unformatted trace data to an existing trace.

Note

- Unformatted trace data (SDATa) can only be imported to memory traces
- Formatted trace data (FDATa) can only be imported to "live" traces if the related channel is in single sweep mode (`INITiate<Ch>:CONTinuous OFF`). Before the import, the target trace must be prepared according to the settings used during export. Any request for new data from the hardware ("Restart Sweep" in single sweep mode or switching to continuous sweep mode) discards imported data and switches back the display to measured data.

Parameters:

<TraceName> String parameter containing the trace name

<Format> FDATa | SDATa | MDATa | NCDat | UCData
Data format; see [Table 11-5](#).

<Data> Trace data for `FDATA` | `SDATA` import either in ASCII or block data format, depending on the current `FORMat[:DATA]` setting. The column order must match the one used during export.

Example: See `CALCulate<Chn>:DATA`.

CALCulate<Ch>:DATA:CALL <Format>, <Data>...

The query reads the current response values of all S-parameter data traces at channel <Ch>'s data access point <DACPoint>.

If a full n-port system error correction is active in the related channel, the command reads the full nxn S-matrix of the calibrated ports (there is no need to create or display the S-parameter traces). Use `CALCulate<Ch>:DATA:CALL:CATalog?` to query the available traces.

The "set direction" allows you to import measurement data at the "Fixture Simulation Input" data access point (see [Chapter 9.1.5, "Data Flow"](#), on page 192).

Note

- Importing data is only supported in single sweep mode (`INITiate<Ch>:CONTInuous OFF`)
- Before importing data, the channel must be configured with the same settings that were used during export (user calibration, balanced port configuration, stimulus axis etc.).
- After importing data, "downstream" parameters in the data flow can be changed and their effect is shown directly
- Any request for new data from the hardware (Restart Sweep in single sweep mode or switching to continuous sweep mode) discards imported data and switches back the display to measured data

Suffix:

<Ch> Channel number

Parameters:

<Format> `SDATA` | `FSIData`

SDATA

Output as unformatted trace data; see `CALCulate<Chn>:DATA`. Query only.

FSIData

Output or input at "Fixture Simulation Input" data access point.

<Data> Trace data either in ASCII or block data format, depending on the current `FORMat[:DATA]` setting. The column order must match the one used during export.

Example: Suppose that a TOSM calibration for ports 1 and 2 is active in channel no. 1.
`CALCulate:DATA:CALL:CATalog?`
 Query the traces available for `CALCulate<Ch>:DATA:CALL?`.
 The response is 'S11, S12, S21, S22'.
`CALCulate:DATA:CALL? SDATa`
 Return the complex response values of all traces. The traces in the catalog list are read one after another: The response array contains n (number of points) pairs of real and imaginary values for S₁₁, followed by n pairs of values for S₁₂, S₂₁, and S₂₂.

CALCulate<Ch>:DATA:CALL:CATalog?

Returns all traces which are available for `CALCulate<Ch>:DATA:CALL` in channel no. <Ch>. The response is a string parameter with all S-parameter traces in the current channel or in the active system error correction; see example.

Suffix:
 <Ch> Channel number

Example: See `CALCulate<Ch>:DATA:CALL`

Usage: Query only

CALCulate<Ch>:DATA:CHANnel:ALL? <Format>

Reads the current response values of all traces of the selected channel.

Suffix:
 <Ch> Channel number

Query parameters:
 <Format> FDATa | SDATa | MDATa
 Output format for the S-parameter data, see `CALCulate<Chn>:DATA`.

Return values:
 <Data> Trace data either in ASCII or block data format, depending on the current `FORMat [:DATA]` setting.

Usage: Query only

CALCulate<Ch>:DATA:CHANnel:DALL? <Format>

Reads the current response values of all data traces of the selected channel. Use `CALCulate<Ch>:DATA:CHANnel:ALL?` to query data traces and memory traces.

Suffix:
 <Ch> Channel number

Query parameters:

<Format> FDATA | SDATA | MDATA
 Output format for the S-parameter data, see
[CALCulate<Chn>:DATA](#).

Return values:

<Data> Trace data either in ASCII or block data format, depending on
 the current [FORMat \[:DATA\]](#) setting.

Usage: Query only

CALCulate<Ch>:DATA:MDATA:INTerpolate

Uses linear inter-/extrapolation to "regrid" all memory traces of the related channel to the channel's current stimulus values.

Suffix:

<Ch> Channel number

Usage: Event

CALCulate<Ch>:DATA:SGRoup? <Format>

Reads the current response values of all S-parameters associated to a group of logical ports (S-parameter group). The S-parameter group must be created before using [CALCulate<Ch>:PARAmeter:DEFine:SGRoup](#).

Suffix:

<Ch> Channel number of the previously defined S-parameter group.

Query parameters:

<Format> FDATA | SDATA | MDATA
 Output format for the S-parameter data, see
[CALCulate<Chn>:DATA](#) on page 602.

Example: See [CALCulate<Ch>:PARAmeter:DEFine:SGRoup](#)

Usage: Query only

CALCulate<Chn>:DATA <Format>, <Data>...**CALCulate<Chn>:DATA? <Format>**

The query reads the response values of the selected channel's active trace or reads error terms of the selected channel.

The "set command" either imports formatted or unformatted trace data to the selected channel's active trace (see [Chapter 9.1.5, "Data Flow"](#), on page 192) or writes error terms of the selected channel.

Note

- The data format is parameter-dependent; see tables below. The unit is the default unit of the measured parameter; see [CALCulate<Ch>:PARAmeter:SDEFine](#).

- Unformatted trace data (SDATa) can only be imported to memory traces
- Formatted trace data (FDATa) can only be imported to "live" traces if the related channel is in single sweep mode (`INITiate<Ch>:CONTinuous OFF`).
Before the import, the target trace must be prepared according to the settings used during export. Any request for new data from the hardware ("Restart Sweep" in single sweep mode or switching to continuous sweep mode) discards imported data and switches back the display to measured data.

Suffix:

<Chn> Channel number used to identify the active trace

Parameters:

<Data> Trace data either in ASCII or block data format, depending on the current `FORMat [:DATA]` setting.

Parameters for setting and query:

<Format> FDATa | SDATa | MDATa | NCDat | UCData | SCORr1 | SCORr2 | SCORr3 | SCORr4 | SCORr5 | SCORr6 | SCORr7 | SCORr8 | SCORr9 | SCORr10 | SCORr11 | SCORr12 | SCORr13 | SCORr14 | SCORr15 | SCORr16 | SCORr17 | SCORr18 | SCORr19 | SCORr20 | SCORr21 | SCORr22 | SCORr23 | SCORr24 | SCORr25 | SCORr26 | SCORr27

See list of parameters below.

Example:

```
*RST; SWE:POIN 20
```

Create a trace with 20 sweep points, making the created trace the active trace of channel 1 (omitted optional mnemonic `SENSe1`).

```
CALC:DATA? FDAT
```

Query the 20 response values of the created trace. In the `FDATa` setting, 20 comma-separated ASCII values are returned.

```
CALC:DATA:STIM?
```

Query the 20 stimulus values of the created trace. 20 comma-separated ASCII values are returned.

```
CALC2:PAR:SDEF 'Trc2', 'S11'
```

Create a second trace in a new channel no. 2. The second trace does not become the active trace and is not displayed.

```
CALC:DATA:TRAC? 'Trc2', FDAT
```

Query the response values of the second (non-active) trace. 20 comma-separated ASCII values are returned.

```
CALC:DATA:ALL? FDAT
```

Query the response values of all traces. 40 comma-separated ASCII values are returned.

Example:**Writing memory traces**

```
*RST; SWE:POIN 3
```

Create a data trace 'Trc1' with 3 sweep points, making the created trace the active trace of channel 1 (omitted optional mnemonic SENSE1).

```
TRAC:COPY 'MemTrc1','Trc1'; :CALC:PAR:SEL
'MemTrc1'
```

Copy the data trace to a memory trace and select the memory trace as an active trace.

```
CALC:DATA SDAT, 1,2, 3,4, 5,6
```

Write numbers (1,2), (3,4), (5,6) to the memory trace.

```
CALC:DATA? SDAT
```

Query the memory trace. The response is 1,2,3,4,5,6.

```
FORM REAL, 32
```

Change the data format to 4-byte block data.

```
CALC:DATA SDAT, #224123456789012345678901234
```

Write 24 bytes (= 4 * 2 * 3 bytes) of data to the memory trace.

The following parameters are related to trace data (see also diagram in [Chapter 9.1.5, "Data Flow"](#), on page 192):

Table 11-5: Data format identifiers used in the CALCulate:DATA... commands

FDATA	Formatted trace data, according to the selected trace format (CALCulate<Chn>:FORMat). One value per trace point for Cartesian diagrams, two values for polar diagrams. [Data access point 6]
SDATA	Unformatted trace data: real and imaginary part of each measurement point. Two values per trace point irrespective of the selected trace format. The trace mathematics is not taken into account. [Data access point 4]
MDATA	Unformatted trace data (see SDATA) after evaluation of trace mathematics. [Data access point 5]
NCData	Factory calibrated trace data: the values are obtained right after applying the factory calibration but before applying a user-defined calibration (if any). [Data access point 1]
UCData	Uncalibrated trace data. [Data access point 0] Note: <ul style="list-style-type: none"> the respective trace must represent a wave quantity or ratio Otherwise an error occurs.

The following parameters denote the error terms generated during a calibration.

Table 11-6: Error terms in the CALCulate:DATA... commands

Error Term	Description	Receive Ports (S-parameter)
SCORr1, ..., SCORr12	2-port error terms; see [SENSe<Ch>:]CORRection:DATA.	1 and 2 (S11, S12, S21, S22)
SCORr13	Directivity	3 (S33)

Error Term	Description	Receive Ports (S-parameter)
SCORr14	Source match	3 (S33)
SCORr15	Reflection tracking	3 (S33)
SCORr16	Isolation	3 (S31)
SCORr17	Load match	3 (S31)
SCORr18	Transmission tracking	3 (S13)
SCORr19	Isolation	1 (S13)
SCORr20	Load match	1 (S13)
SCORr21	Transmission tracking	1 (S13)
SCORr22	Isolation	3 (S32)
SCORr23	Load match	3 (S32)
SCORr24	Transmission tracking	3 (S32)
SCORr25	Isolation	2 (S23)
SCORr26	Load match	2 (S23)
SCORr27	Transmission tracking	2 (S23)

Note: The error terms are channel-specific; they apply to the active calibration of channel no. <Chn> or to the factory calibration (if no channel calibration is active). For the factory calibration, the query form is allowed only (no change of factory calibration data).

Tip: Use the generalized command `[SENSe<Ch>:]CORRection:CDATa` to read or write error terms for arbitrary analyzer ports. For additional programming examples refer to "Saving and Recalling Error Terms" on page 983.

CALCulate<Chn>:DATA:NSweep[:LAST]? <Format>, <RvCount>

Reads the response values of a trace acquired in single sweep mode (`INITiate<Ch>:CONTInuous OFF`). The trace can be any of the traces acquired during the single sweep cycle.

Tip:

- This command can only be used for `[SENSe<Ch>:]SWEep:COUNT > 1`.
- Ensure that the single sweep is terminated before using this command, otherwise the results of the trace count will be unpredictable (see example below). Alternatively, use the `CALCulate<Chn>:DATA:NSweep:FIRSt?` command.

Suffix:

<Chn> Channel number used to identify the active trace

Query parameters:

<Format>	SDATa Read unformatted sweep data (fixed parameter): Returns the real and imaginary part of each measurement point (2 values per trace point, irrespective of the selected trace format).
<RvCount>	Number of sweep to be read. 1 denotes the last sweep acquired, 2 denotes the second-last and so forth. Range: 1 to sweep count defined via [SENSe<Ch>:]SWEep:COUNT

Example:

```
SWE:COUN 10
```

Define the number of sweeps (10) to be measured in single sweep mode.

```
INIT:CONT OFF; :INIT; *OPC?
```

Activate single sweep mode and start a single sweep sequence in channel no. 1. Wait until the single sweep sequence is complete.

```
CALC:DATA:NSW? SDAT, 3
```

Query the results of the 8th sweep.

See also "[Retrieving the Results of Previous Sweeps](#)" on page 980.

Usage: Query only

CALCulate<Chn>:DATA:NSweep:COUNT?

Reads the number of completed sweeps in single sweep mode ([INITiate<Ch>:CONTinuous](#) OFF). The trace can be any of the traces acquired during the single sweep cycle.

Tip:

This command can only be used for [[SENSe<Ch>:\]SWEep:COUNT](#) > 1.

Suffix:

<Chn> Channel number used to identify the active trace

Example: See [CALCulate<Chn>:DATA:NSweep:FIRSt?](#)

Usage: Query only

CALCulate<Chn>:DATA:NSweep:FIRSt? <Format>, <FwCount>[, <FwCountEnd>]

Reads the response values of a trace or a consecutive group of traces acquired in single sweep mode ([INITiate<Ch>:CONTinuous](#) OFF).

Tip:

This command can only be used for [[SENSe<Ch>:\]SWEep:COUNT](#) > 1.

Suffix:

<Chn> Channel number used to identify the active trace

Query parameters:

<Format>	SDATa Read unformatted sweep data (fixed parameter): Returns the real and imaginary part of each measurement point (2 values per trace point irrespective of the selected trace format).
<FwCount>	Number of first sweep to be read. 1 denotes the first sweep acquired, 2 denotes the second and so forth. The sweep count in single sweep mode is defined via [SENSe<Ch>:]SWEep:COUNt . Range: 1 to sweep count
<FwCountEnd>	Number of last sweep to be read. If this parameter is omitted, it is implicitly set to <FwCount> (a single sweep is read). Range: <FwCount> to sweep count

Return values:

<Data>	Response values either in ASCII or block data format, depending on the current FORMat[:DATA] setting.
---------------------	---

Example:

```
SWE:COUN 10
Define the number of sweeps (10) to be measured in single sweep mode.
INIT:CONT OFF; :INIT;
Activate single sweep mode and start a single sweep sequence in channel no. 1. No synchronization is necessary.
if (CALC:DATA:NSW:COUN? > 4)
CALC:DATA:NSW:FIRS? SDAT, 5
Wait until 5 sweeps have been measured, then query the results of the 5th sweep.
See also "Retrieving the Results of Previous Sweeps" on page 980.
```

Usage: Query only

CALCulate<Chn>:DATA:STIMulus?

Reads the stimulus values of the active data or memory trace.

Suffix:

<Chn> Channel number used to identify the active trace

Example: See [CALCulate<Chn>:DATA](#)

Usage: Query only

CALCulate:DLINe...

The [CALCulate:DLINe...](#) commands control the horizontal line used to mark and retrieve response values (display line).

CALCulate<Chn>:DLINe	608
CALCulate<Chn>:DLINe:STATe	608

CALCulate<Chn>:DLINe <Position>

Defines the position (response value) of the horizontal line.

Suffix:

<Chn> Channel number used to identify the active trace

Parameters:

<Position> See list of parameters below.

Default unit: NN

Example:

```
*RST; :CALC:DLIN 10
```

Define the position of the horizontal line in the default dB Mag diagram at +10 dB.

```
CALC:DLIN:STAT ON
```

Display the defined horizontal line.

Manual operation: See ["Response Value"](#) on page 429

CALCulate<Chn>:DLINe:STATe <Boolean>

Switches the horizontal line on or off.

Suffix:

<Chn> Channel number used to identify the active trace

Parameters:

<Boolean> ON | OFF - horizontal line on or off

```
*RST: OFF
```

Example:

See [CALCulate<Chn>:DLINe](#)

Manual operation: See ["Show Horiz. Line"](#) on page 429

CALCulate:FILTer[:GATE]...

The `CALCulate:FILTer[:GATE]...` commands define the properties of the time gate which is used to optimize the time domain response.

CALCulate:FILTer[:GATE]:TIME:AOffset	609
CALCulate<Chn>:FILTer[:GATE]:TIME[:TYPE]	609
CALCulate<Chn>:FILTer[:GATE]:TIME:CENTer	610
CALCulate<Chn>:FILTer[:GATE]:TIME:DCHebyshev	610
CALCulate<Chn>:FILTer[:GATE]:TIME:SHAPE	610
CALCulate<Chn>:FILTer[:GATE]:TIME:SHOW	611
CALCulate<Chn>:FILTer[:GATE]:TIME:SPAN	611
CALCulate<Chn>:FILTer[:GATE]:TIME:START	612
CALCulate<Chn>:FILTer[:GATE]:TIME:STOP	612
CALCulate<Chn>:FILTer[:GATE]:TIME:STATE	612
CALCulate<Chn>:FILTer[:GATE]:TIME:WINDow	613

CALCulate:FILTer[:GATE]:TIME:AOFFset <Boolean>

Activates the operating mode where the time gate is moved in the opposite direction when the "Delay" setting is changed.

Parameters:

<Boolean> ON | OFF - enable or disable "Adjust Time Gate".
*RST: OFF

Example:

```
*RST; :CALCulate1:TRANSform:TIME:STATE ON
CALCulate1:FILTer:GATE:TIME:STATE ON; SHOW ON
Activate time domain representation and a time gate in channel
no. 1. Display the time gate
CALCulate1:FILTer:GATE:TIME:START 2ns; STOP 3
ns
Restrict the time gate to the time interval between 2 ns and 3 ns.
CALCulate:FILTer:GATE:TIME:AOFFset ON
Activate an offset of the time gate according to a new delay set-
ting.
SENSE1:CORRection:EDELay1:TIME 1ns
Specify a 1 ns delay at port 1.
CALCulate1:FILTer:GATE:TIME:START?; STOP?
Query the time gate position. The response is 1E-009;2E-009.
```

Manual operation: See "[Adjust Time Gate](#)" on page 501

CALCulate<Chn>:FILTer[:GATE]:TIME[:TYPE] <TimeGateFilter>

Selects the time gate filter type, defining what occurs to the data in the specific time region.

Suffix:

<Chn> Channel number used to identify the active trace

Parameters:

<TimeGateFilter> BPASs | NOTCh

BPASs

Band pass filter: Pass all information in specified time region and reject everything else

NOTCh

Notch filter: Reject all information in specified time region and pass everything else

*RST: BPASs

Example:

```
*RST; :CALC:FILT:TIME:STAT ON
Reset the instrument and enable the time gate.
CALC:FILT:TIME NOTCh
Select a notch filter in order to reject unwanted pulses.
```

Manual operation: See "[Bandpass / Notch](#)" on page 350

CALCulate<Chn>:FILTer[:GATE]:TIME:CENTer <CenterTime>

Defines the center time of the time gate.

Suffix:

<Chn> Channel number used to identify the active trace

Parameters:

<CenterTime> Center time of the time gate
 Range: -99.8999999 s to +99.8999999 s
 Increment: 0.1 ns
 *RST: 1.5E-009 s
 Default unit: s

Example:

```
*RST; :CALC:TRAN:TIME:STAT ON; :CALC:FILT:TIME:STAT ON
```

Reset the instrument and enable the time domain representation and the time gate.

```
CALC:FILT:TIME:CENT 0; SPAN 5ns
```

Set the center time to 0 ns and the time span to 5 ns.

Manual operation: See ["Axis Pair"](#) on page 350

CALCulate<Chn>:FILTer[:GATE]:TIME:DCHebyshev <SidebandSupp>

Sets the sideband suppression for the Dolph-Chebyshev time gate. The command is only available if a Dolph-Chebyshev time gate is active ([CALCulate<Chn>:FILTer\[:GATE\]:TIME:WINDow DCHebyshev](#)).

Suffix:

<Chn> Channel number used to identify the active trace

Parameters:

<SidebandSupp> Sideband suppression
 Range: 10 dB to 120 dB
 Increment: 10 dB
 *RST: 32 dB
 Default unit: dB

Example:

```
*RST; :CALC:FILT:TIME:WIND DCH
```

Reset the instrument and select a Dolph-Chebyshev time gate for filtering the data in the frequency domain.

```
CALC:FILT:TIME:DCH 25
```

Set the sideband suppression to 25 dB.

Manual operation: See ["Side Lobe Level"](#) on page 351

CALCulate<Chn>:FILTer[:GATE]:TIME:SHAPE <TimeGate>

Selects the time gate to be applied to the time domain transform.

Tip:

Use the generalized command `CALCulate<Chn>:FILTer[:GATE]:TIME:WINDow` if you wish to select a Dolph-Chebyshev time gate.

Suffix:

<Chn> Channel number used to identify the active trace

Parameters:

<TimeGate> MAXimum | WIDE | NORMal | MINimum
 MINimum - Steepest edges (rectangle)
 WIDE - Normal gate (Hann)
 NORM - Steep edges (Hamming)
 Maximum - Maximum flatness (Bohman)
 *RST: WIDE

Example:

*RST; :CALC:FILT:TIME:SHAP?

Reset the instrument and query the type of time gate used. The response is WIDE.

Manual operation: See "Shape" on page 350

CALCulate<Chn>:FILTer[:GATE]:TIME:SHOW <Boolean>

Enables or disables permanent display of the gate limits.

Suffix:

<Chn> Channel number used to identify the active trace

Parameters:

<Boolean> ON - time gate permanently displayed
 OFF - time gate hidden
 *RST: OFF

Example:

See `CALCulate<Chn>:FILTer[:GATE]:TIME:CENTer`

Manual operation: See "Show Range Lines" on page 350

**CALCulate<Chn>:FILTer[:GATE]:TIME:SPAN **

Defines the span of the time gate.

Suffix:

<Chn> Channel number used to identify the active trace

Parameters:

 Span of the time gate.
 Range: 2E-012 s to 200 s
 Increment: 0.1 ns
 *RST: 5E-009 s
 Default unit: s

Example:

See `CALCulate<Chn>:FILTer[:GATE]:TIME:CENTer`

Manual operation: See "Axis Pair" on page 350

CALCulate<Chn>:FILTer[:GATE]:TIME:STARt <StartTime>

CALCulate<Chn>:FILTer[:GATE]:TIME:STOP <StopTime>

These commands define the start and stop times of the time gate, respectively.

Suffix:

<Chn> Channel number used to identify the active trace

Parameters:

<StopTime> Start or stop time of the time gate.

Range: -100 s to +99.999999999998 s (start time) and
-99.999999999998 s to +100 s (stop time)

Increment: 0.1 ns

*RST: -1E-009 s (start time) to +4E-009 s (stop time)

Default unit: s

Example:

```
*RST; :CALC:TRAN:TIME:STAT ON; :CALC:FILT:TIME:
STAT ON
```

Reset the instrument and enable the time domain representation and the time gate.

```
CALC:FILT:TIME:STAR 0; STOP 10ns; SHOW ON
```

Set the start time to 0 ns and the stop time to 10 ns and display the time gate permanently.

Manual operation: See "Axis Pair" on page 350

Note: If the start frequency entered is greater than the current stop frequency, the stop frequency is set to the start frequency plus the minimum frequency span (`CALCulate<Chn>:FILTer[:GATE]:TIME:SPAN`).

If the stop frequency entered is smaller than the current start frequency, the start frequency is set to the stop frequency minus the minimum frequency span.

CALCulate<Chn>:FILTer[:GATE]:TIME:STATe <Boolean>

Determines whether the time gate for trace no. <Chn> is enabled.

Suffix:

<Chn> Channel number used to identify the active trace

Parameters:

<Boolean> ON - time gate enabled
OFF - time gate disabled

*RST: OFF

Example:

```
*RST; :CALC:TRAN:TIME:STAT?
CALC:FILT:TIME:STAT?
```

Reset the instrument, activating a frequency sweep, and query whether the default trace is displayed in the time domain and whether the time gate is enabled. The response to both queries is 0.

Manual operation: See "Time Gate" on page 350

CALCulate<Chn>:FILTer[:GATE]:TIME:WINDow <TimeGate>

Selects the time gate to be applied to the time domain transform.

Suffix:

<Chn> Channel number used to identify the active trace

Parameters:

<TimeGate> RECT | HAMMing | HANNing | BOHMan | DCHebyshev
 RECT - steepest edges (rectangle)
 HANN - normal gate (Hann)
 HAMMing - steep edges (Hamming)
 BOHMan - minimum flatness (Bohman)
 DCHebyshev - arbitrary gate shape (Dolph-Chebyshev)
 *RST: HANN

Example: See `CALCulate<Chn>:FILTer[:GATE]:TIME:DCHebyshev`

Manual operation: See "Shape" on page 350

CALCulate:FORMat...

The `CALCulate:FORMat...` commands determine the post-processing of the measured data in order to obtain various display formats.

CALCulate<Chn>:FORMat <Type>

Defines how the measured result at any sweep point is post-processed and presented in the graphical display.

Note: The analyzer allows arbitrary combinations of display formats and measured quantities; see [Chapter 10.8, "Format Softtool"](#), on page 395 and `CALCulate<Ch>:PARAmeter...` commands. Nevertheless, it is advisable to check which display formats are generally appropriate for an analysis of a particular measured quantity; see [Chapter 9.2.3.3, "Measured Quantities and Trace Formats"](#), on page 217.

Suffix:

<Chn> Channel number used to identify the active trace

Parameters:

<Type> MLINear | MLOGarithmic | PHASe | UPHase | POLar | SMITH |
 ISMith | GDELay | REAL | IMAGinary | SWR | COMPLex |
 MAGNitude | LOGarithmic
 See list of parameters below.
 *RST: MLOGarithmic

Example:

```
CALC4:PAR:SDEF 'Ch4Tr1', 'S11'
```

Create channel 4 and a trace named Ch4Tr1 to measure the input reflection coefficient S_{11} . The trace becomes the active trace in channel 4.

```
CALC4:FORM MLIN; :DISP:WIND:TRAC2:FEED 'CH4TR1'
```

Calculate the magnitude of S_{11} and display it in a linearly scaled Cartesian diagram, assigning the trace number 2.

Manual operation: See "dB Mag" on page 395

Assume that the result at a sweep point is given by the complex quantity $z = x + jy$. Then the magnitude of z is calculated as

$$|z| = \sqrt{x^2 + y^2}$$

and in phase notation we have

$$z = |z| e^{j \text{Phase}(z)}, \text{ where } \text{Phase}(z) = \arctan(y/x).$$

The meaning of the parameters is as follows (see also table in [CALCulate<Chn>:MARKer<Mk>:FORMat](#) description):

MLINear	Displays $ z $ in a Cartesian diagram
MLOGarithmic MAGNitude (for compatibility with R&S ZVR analyzers)	Calculates $ z $ in dB ($= 20 \log z $) and displays it in a Cartesian diagram
PHASe	Calculates $\text{Phase}(z)$ in the range between -180° and $+180^\circ$ and displays it in a Cartesian diagram
UPHase	Calculates $\text{Phase}(z)$ (unwrapped) and displays it in a Cartesian diagram
POLar COMPLex (for compatibility with R&S ZVR analyzers)	Displays z in a polar diagram
SMITH	Displays z in a Smith diagram
ISMith	Displays z in an inverted Smith diagram
GDELay	For frequency sweeps only Calculates the group delay at the related sweep point and displays it in a Cartesian diagram
REAL	Calculates $\text{Re}(z) = x$ and displays it in a Cartesian diagram
IMAGinary	Calculates $\text{Im}(z) = y$ and displays it in a Cartesian diagram
SWR	Calculates the standing wave ratio $(1 + z) / (1 - z)$ and displays it in a Cartesian diagram
LOGarithmic	Displays z in a Cartesian diagram with logarithmic scale

CALCulate<Chn>:FORMat:WQUType <Unit>

Selects the physical unit of the displayed trace.

Suffix:

<Chn> Channel number used to identify the active trace

Parameters:

<Unit> POWER | VOLTage
Power or voltage units
*RST: POWER

Example:

```
CALC4:PAR:SDEF 'Ch4Tr1', 'b1'
```

Create channel 4 and a trace named Ch4Tr1 to measure the wave quantity b_1 . The trace becomes the active trace in channel 4.

```
CALC4:FORM:WQUType VOLT
```

Select voltage units for the created trace (identified by the suffix 4).

Manual operation: See ["Show as"](#) on page 388

CALCulate:GDAPerture...

The CALCulate:GDAPerture... commands configure the group delay measurement.

CALCulate<Chn>:GDAPerture:SCount <Steps>

Defines an aperture for the calculation of the group delay as an integer number of frequency sweep steps.

Suffix:

<Chn> Channel number used to identify the active trace

Parameters:

<Steps> Number of steps
Range: 1 to 10000
*RST: 10

Example:

```
*RST; :CALC:FORM GDEL
```

Select group delay calculation for the active trace.

```
CALC:GDAP:SCO 15
```

Select an aperture of 15 steps.

Manual operation: See ["Aperture Points"](#) on page 400

CALCulate:IAverage**CALCulate<Chn>:IAverage[:STATE] <Boolean>**

Turns infinite averaging on or off.

The averaging mode can be selected using CALCulate<Chn>:IAverage:MODE.

Suffix:

<Chn> Channel number used to identify the active trace

Parameters:

<Boolean> ON | OFF | 1 | 0

*RST: 0

Manual operation: See "Infinite Average/Restart" on page 367

CALCulate<Chn>:IAverage:MODE <Mode>

Selects the quantities to be averaged if infinite averaging is enabled

(CALCulate<Chn>:IAverage[:STATe] ON).

Suffix:

<Chn> Channel number used to identify the active trace

Parameters:

<Mode> MAGPhase | REIMag

Selects the averaging mode.

MAGPhase

Averaging of magnitude and phase (default) of the complex trace value

REIMag

Averaging of real and imaginary part of the complex trace value

Manual operation: See "Mode" on page 367

CALCulate:LIMit...

The CALCulate:LIMit... commands define the limit lines and control the limit check.

CALCulate:LIMit:CIRClE:FAIL:ALL?	617
CALCulate:LIMit:FAIL:ALL?	617
CALCulate:LIMit:FAIL:DATA?	617
CALCulate<Chn>:LIMit:CIRClE[:STATe]	618
CALCulate<Chn>:LIMit:CIRClE:CLear	618
CALCulate<Chn>:LIMit:CIRClE:DATA	618
CALCulate<Chn>:LIMit:CIRClE:DISPlay[:STATe]	619
CALCulate<Chn>:LIMit:CIRClE:FAIL?	619
CALCulate<Chn>:LIMit:CIRClE:SOUNd[:STATe]	619
CALCulate<Chn>:LIMit:CLear	620
CALCulate<Chn>:LIMit:CONTRol[:DATA]	620
CALCulate<Chn>:LIMit:CONTRol:SHIFt	621
CALCulate<Chn>:LIMit:DATA	621
CALCulate<Chn>:LIMit:DCIRclE[:STATe]	622
CALCulate<Chn>:LIMit:DCIRclE:CLear	623
CALCulate<Chn>:LIMit:DCIRclE:DATA	623
CALCulate<Chn>:LIMit:DCIRclE:DISPlay[:STATe]	623
CALCulate<Chn>:LIMit:DELeTe:ALL	623

CALCulate<Chn>:LIMit:DISPlay[:STATe].....	624
CALCulate<Chn>:LIMit:FAIL?.....	624
CALCulate<Chn>:LIMit:LOWer[:DATA].....	625
CALCulate<Chn>:LIMit:UPPer[:DATA].....	625
CALCulate<Chn>:LIMit:LOWer:FEED.....	626
CALCulate<Chn>:LIMit:UPPer:FEED.....	626
CALCulate<Chn>:LIMit:LOWer:SHIFt.....	627
CALCulate<Chn>:LIMit:UPPer:SHIFt.....	627
CALCulate<Chn>:LIMit:SEGment<Seg>:AMPLitude:STARt.....	628
CALCulate<Chn>:LIMit:SEGment<Seg>:AMPLitude:STOP.....	628
CALCulate<Chn>:LIMit:SEGment:COUNT?.....	628
CALCulate<Chn>:LIMit:SEGment<Seg>:FORMula.....	629
CALCulate<Chn>:LIMit:SEGment<Seg>:FORMula:STATe.....	629
CALCulate<Chn>:LIMit:SEGment<Seg>:INTerpol.....	630
CALCulate<Chn>:LIMit:SEGment<Seg>:STIMulus:STARt.....	630
CALCulate<Chn>:LIMit:SEGment<Seg>:STIMulus:STOP.....	630
CALCulate<Chn>:LIMit:SEGment<Seg>:TYPE.....	631
CALCulate<Chn>:LIMit:SOUNd[:STATe].....	632
CALCulate<Chn>:LIMit:STATe.....	632
CALCulate<Chn>:LIMit:STATe:AREA.....	632
CALCulate<Chn>:LIMit:TTLout<Pt>[:STATe].....	633

CALCulate:LIMit:CIRClE:FAIL:ALL? [<ChannelSetup>]

Returns a 0 or 1 to indicate whether or not the circle limit check has failed for at least one channel in the referenced channel setup. 0 represents pass and 1 represents fail

Query parameters:

<ChannelSetup> Name of a VNA channel setup. Can be omitted if the active VNA channel setup shall be referenced.

Usage: Query only

Manual operation: See "[Limit Check](#)" on page 425

CALCulate:LIMit:FAIL:ALL? [<ChannelSetup>]

Returns a 0 or 1 to indicate whether or not the limit line check has failed for at least one channel in the referenced channel setup. 0 represents pass and 1 represents fail.

Query parameters:

<ChannelSetup> Name of a VNA channel setup. Can be omitted if the active VNA channel setup shall be referenced.

Usage: Query only

Manual operation: See "[Limit Check](#)" on page 412

CALCulate:LIMit:FAIL:DATA? <TraceName>, <LimitFailType>

Returns those sweep points that have caused a limit violation of the given <LimitFailType> for trace <TraceName>.

Query parameters:

<TraceName> Trace name, uniquely identifying the related trace

<LimitFailType> LIMit | RIPPlE | CIRCle
Limit (fail) type

Usage: Query only

CALCulate<Chn>:LIMit:CIRCle[:STATe] <Boolean>

Switches the circle limit check on or off.

Suffix:

<Chn> Channel number used to identify the active trace

Parameters:

<Boolean>

Example:

```
*RST; CALCulate:LIMit:CIRCle:DATA 0, 0, 0.5
```

Define a circle limit line centered around the origin of the polar diagram, assigning a radius of 0.5 U.

```
CALCulate:LIMit:CIRCle:STATe ON; FAIL?
```

Switch the limit check on and query the result.

Manual operation: See "[Limit Check](#)" on page 425

CALCulate<Chn>:LIMit:CIRCle:CLEar

Resets the circle test for the active trace of channel <Chn>.

Suffix:

<Chn> Channel number used to identify the active trace

Usage: Event

Manual operation: See "[Clear Test](#)" on page 427

CALCulate<Chn>:LIMit:CIRCle:DATA <CenterX>, <CenterY>, <Radius>

Defines a circle limit lines by its center coordinates and its radius.

Suffix:

<Chn> Channel number used to identify the active trace

Parameters:

<CenterX> Range: Virtually no restriction for center coordinates.
*RST: 0
Default unit: NN

<CenterY> Range: Virtually no restriction for center coordinates.
*RST: 0
Default unit: NN

<Radius> Range: Virtually no restriction for radius (use positive values).
 *RST: 1
 Default unit: NN

Example: See `CALCulate<Chn>:LIMit:CIRClE[:STATe]`

Manual operation: See "Radius / Center X / Center Y" on page 427

`CALCulate<Chn>:LIMit:CIRClE:DISPlay[:STATe]` <Boolean>

Displays or hides the circle limit line associated to the active trace.

Suffix:

<Chn> Channel number used to identify the active trace

Parameters:

<Boolean> ON | OFF - Circle limit line on or off.

*RST: OFF

Example:

```
*RST; CALCulate:LIMit:CIRClE:DATA 0, 0, 0.5
```

Define a circle limit line centered around the origin of the polar diagram, assigning a radius of 0.5 U.

```
CALCulate:FORMat POLar
```

```
CALCulate:LIMit:CIRClE:DISPlay ON
```

Activate a polar diagram and show the circle limit line in the diagram.

Manual operation: See "Show Limit Circle" on page 425

`CALCulate<Chn>:LIMit:CIRClE:FAIL?`

Returns a 0 or 1 to indicate whether or not the circle limit check has failed. 0 represents pass and 1 represents fail

Tip: Use `CALCulate:CLIMits:FAIL?` to perform a composite (global) limit check.

Suffix:

<Chn> Channel number used to identify the active trace

Example:

See `CALCulate<Chn>:LIMit:CIRClE[:STATe]`

Usage:

Query only

Manual operation: See "Limit Check" on page 425

`CALCulate<Chn>:LIMit:CIRClE:SOUNd[:STATe]` <Boolean>

Switches the acoustic signal (fail beep) on or off. The fail beep is generated each time the analyzer detects an exceeded circle limit.

Suffix:

<Chn> Channel number used to identify the active trace

Parameters:

<Boolean> ON | OFF - Fail beep on or off.
 *RST: OFF

Example:

CALCulate:LIMit:CIRClE:STATe ON; SOUND ON
 Switch the limit check on and activate the fail beep.

Manual operation: See "[Limit Fail Beep](#)" on page 426

CALCulate<Chn>:LIMit:CLEar

Resets the limit check results for the limit line test.

Suffix:

<Chn> Channel number used to identify the active trace

Usage:

Event

Manual operation: See "[Clear Test](#)" on page 414

CALCulate<Chn>:LIMit:CONTRol[:DATA] <StartStim>, <StopStim>[, ...]

Defines the stimulus values of the limit line and/or creates new limit line segments. See also [Chapter 9.4.1.1, "Rules for Limit Line Definition"](#), on page 232.

Rules for creating segments

The following rules apply to an active trace with n existing limit line segments:

- An odd number of values is rejected; an error message -109, "Missing parameter..." is generated.
- An even number of 2*k values updates or generates k limit line segments.
- For n > k the stimulus values of all existing limit line segments no. 1 to k are updated, the existing limit line segments no. k+1, ..., n are deleted.
- For n < k the stimulus values of the limit line segments no. 1 to n are updated, the limit line segments n+1, ..., k are generated with default response values (see [CALCulate<Chn>:LIMit:UPPer\[:DATA\]](#), [CALCulate<Chn>:LIMit:LOWer\[:DATA\]](#)).

Note: The generated segments are upper or lower limit line segments, depending on the [CALCulate<Chn>:LIMit:SEGment<Seg>:TYPE](#) setting.

[CALCulate<Ch>:LIMit:CONTRol\[:DATA\]](#) does not overwrite the type setting.

Tip: To define additional new limit line segments without overwriting the old segments use [CALCulate<Chn>:LIMit:DATA](#).

Suffix:

<Chn> Channel number used to identify the active trace

Parameters:

<StartStim>

<StopStim>	<p>Pairs of stimulus values, each pair confining a limit line segment. See also Chapter 9.4.1.1, "Rules for Limit Line Definition", on page 232.</p> <p>If not specified, the units are adjusted to the sweep type of the active channel (<code>[SENSE<Ch>:]SWEep:TYPE</code>).</p> <p>Range: Virtually no restriction for limit segments.</p> <p>*RST: A segment that is created implicitly, e.g. by means of <code>CALCulate<Ch>:LIMit:UPPer[:DATA]</code> or <code>CALCulate<Ch>:LIMit:LOWer[:DATA,]</code>, covers the maximum sweep range of the analyzer.</p>
Example:	<pre>*RST; :CALC:LIM:CONT 1 GHZ, 2 GHZ</pre> <p>Select a lin. frequency sweep (default) and define an upper limit line segment in the stimulus range between 1 GHz and 2 GHz, using default response values (-40 dB).</p> <pre>CALC:LIM:DISP ON</pre> <p>Show the limit line segment in the active diagram.</p>
Manual operation:	See "Segment List" on page 416

CALCulate<Chn>:LIMit:CONTRol:SHIFt <LimShift>

Shifts an existing limit line in horizontal direction. See also [Chapter 9.4.1.1, "Rules for Limit Line Definition"](#), on page 232.

Suffix:

<Chn> Channel number used to identify the active trace

Setting parameters:

<LimShift> Offset value for the limit line

Range: Virtually no restriction for limit segments

Default unit: NN

Example:

```
*RST; :CALC:LIM:CONT 1 GHZ, 2 GHZ
```

Define a limit line segment in the stimulus range between 1 GHz and 2 GHz, using default response values.

```
CALC:LIM:CONT:SHIF 1; :CALC:LIM:CONT?
```

Shift the segment by 1 Hz. The modified limit line segment ranges from 1000000001 (Hz) to 2000000001 (Hz).

Usage: Setting only

Manual operation: See ["Shift Lines"](#) on page 415

CALCulate<Chn>:LIMit:DATA <Type>, <StartStim>, <StopStim>, <StartResp>, <StopResp>

Defines the limit line type, the stimulus and response values for a limit line with an arbitrary number of limit line segments. See [Chapter 9.4.1.1, "Rules for Limit Line Definition"](#), on page 232.

Note: In contrast to `CALCulate<Chn>:LIMit:CONTRol[:DATA]`, this command does not overwrite existing limit line segments. The defined segments are appended to the segment list as new segments.

Suffix:

<Chn> Channel number used to identify the active trace

Parameters:

<Type> Identifier for the type of the limit line segment:
 0 – limit line segment off, segment defined but no limit check performed.

1 – upper limit line segment

2 – lower limit line segment

Range: 0, 1, 2 (see above)

<StartStim>, <StopStim>, <StartResp>, <StopResp> Stimulus and response values of the first and last points of the limit line segment.

The unit of the stimulus values is adjusted to the sweep type of the active channel (`[SENSe<Ch>:]SWEep:TYPE`), the unit of the ripple limit is adjusted to the format of the active trace (`CALCulate<Chn>:FORMat`).

Example:

```
*RST; :CALC:LIM:CONT 1 GHz, 1.5 GHz
```

Define an upper limit line segment in the stimulus range between 1 GHz and 1.5 GHz, using default response values.

```
CALC:LIM:DATA 1, 1500000000, 2000000000, 2, 3
```

Define an upper limit line segment in the stimulus range between 1.5 GHz and 2 GHz, assigning response values of +2 dB and +3 dB.

```
CALC:LIM:DISP ON
```

Show the limit line segment in the active diagram.

Manual operation: See "[Segment List](#)" on page 416

CALCulate<Chn>:LIMit:DCIRcle[:STATE] <Boolean>

Sets/queries the state of the display circle for the active trace of channel <Chn>.

The display circle is defined using `CALCulate<Chn>:LIMit:DCIRcle:DATA`.

Suffix:

<Chn> Channel number used to identify the active trace

Parameters:

<Boolean> If set to ON, only trace points within the display circle are shown at the GUI whenever the related trace is displayed in complex format.

Manual operation: See "[Limit to Circle On/Off](#)" on page 428

CALCulate<Chn>:LIMit:DCIRcle:CLEar

Resets the display circle to its default configuration (unit circle; show border: off; limit to circle: off).

Suffix:

<Chn> Channel number used to identify the active trace

Usage:

Event

Manual operation: See "[Clear Circle](#)" on page 428

CALCulate<Chn>:LIMit:DCIRcle:DATA <CenterX>, <CenterY>, <Radius>

Defines the display circle for the active trace of channel <Chn>.

Suffix:

<Chn> Channel number used to identify the active trace

Parameters:

<CenterX> X position (real part) of the display circle's center

<CenterY> Y position (imaginary part) of the display circle's center

<Radius> Radius of the display circle

Manual operation: See "[Draw Circle / Radius, Center X, Center Y](#)" on page 428

CALCulate<Chn>:LIMit:DCIRcle:DISPlay[:STATe] <Boolean>

Sets/queries the visibility of the display circle for the active trace of channel <Chn>.

The display circle is defined using [CALCulate<Chn>:LIMit:DCIRcle:DATA](#).

Suffix:

<Chn> Channel number used to identify the active trace

Parameters:

<Boolean> If set to ON, the line of the display circle is shown whenever the related trace is displayed in complex format.

Manual operation: See "[Show Border](#)" on page 428

CALCulate<Chn>:LIMit:DELeTe:ALL

Deletes all limit line segments.

Suffix:

<Chn> Channel number used to identify the active trace

Example: `*RST; :CALC:LIM:CONT 1 GHZ, 1.5 GHZ`
 Define an upper limit line segment in the stimulus range between 1 GHz and 1.5 GHz, using default response values.
`CALC:LIM:DATA 1,1500000000, 2000000000,2,3`
 Define an upper limit line segment in the stimulus range between 1.5 GHz and 2 GHz, assigning response values of +2 dB and +3 dB.
`CALC:LIM:DEL:ALL`
 Delete both created limit line segments.

Usage: Event

Manual operation: See ["Add / Insert / Delete / Delete All"](#) on page 417

CALCulate<Chn>:LIMit:DISPlay[:STATe] <Boolean>

Displays or hides the entire limit line (including all segments) associated to the active trace.

Suffix:
 <Chn> Channel number used to identify the active trace

Parameters:
 <Boolean> ON | OFF - Limit line on or off.
 *RST: OFF

Example: `*RST; :CALC:LIM:CONT 1 GHZ, 2 GHZ`
 Define an upper limit line segment in the stimulus range between 1 GHz and 2 GHz, using default response values.
`CALC:LIM:DISP ON`
 Show the limit line segment in the active diagram.

Manual operation: See ["Show Limit Line"](#) on page 412

CALCulate<Chn>:LIMit:FAIL?

Returns a 0 or 1 to indicate whether or not the limit check has failed. 0 represents pass and 1 represents fail

Tip: Use `CALCulate:CLIMits:FAIL?` to perform a composite (global) limit check.

Since V2.20 of the R&S ZNL/ZNLE FW the result is automatically recalculated whenever a relevant setting is changed, i.e. a subsequent query will return the updated limit violation state.

Suffix:
 <Chn> Channel number used to identify the active trace

- Example:** *`RST; :CALC:LIM:CONT 1 GHZ, 2 GHZ`
 Define an upper limit line segment in the stimulus range
 between 1 GHz and 2 GHz, using default response values.
 `CALC:LIM:STAT ON; FAIL?`
 Switch the limit check on and query the result.
 `CALC:LIM:STAT:AREA LEFT, TOP`
 For a subsequent check at the GUI or a hardcopy, move the
 pass/fail message to the top left position.
- Usage:** Query only
- Manual operation:** See "[Limit Check](#)" on page 412

CALCulate<Chn>:LIMit:LOWer[:DATA] <ResponseValue>, <ResponseValue>...
CALCulate<Chn>:LIMit:UPPer[:DATA] <StartResponse>,
 <StopResponse>[,<StartResponse>, <StopResponse>[,...]]

Sets/gets the response (y-axis) values of the lower/upper limit lines and/or creates new limit line segments. See also [Chapter 9.4.1.1, "Rules for Limit Line Definition"](#), on page 232.

Note that in contrast to commands addressing a single limit line segment <Seg> (such as `CALCulate<Chn>:LIMit:SEGment<Seg>:TYPE`), these commands **assume** that

- lower limit line segments are assigned even numbers (<Seg> = 2, 4, 6, ...) and
- upper limit line segments are assigned odd numbers (<Seg> = 1, 3, 5, ...).

`CALCulate<Chn>:LIMit:LOWer/UPPer` sets the type and response values of even/odd limit line segments and gets the response values of even/odd limit line segments - no matter what the current type of these segments actually is!

Both commands will only work, if the total number of limit line segments is even.

Rules for creating and updating segments

Suppose that the active trace is equipped with 2s limit line segments (of any type) and k pairs of response values are passed with the command.

- `CALCulate:LIMit:LOWer`
 - deletes "obsolete" limit line segments 2k+1, ..., 2s
 - updates even limit line segments 2, 4, ..., 2s with type=lower and the given response values
 - creates lower limit line segments 2s+2, 2s+4, ..., 2k with (type=lower and) the given response values
 - creates "missing" upper limit line segments 2s+1, 2s+3, ..., 2k-1 with (type=upper and) default response values
- `CALCulate:LIMit:UPPer`
 - deletes "obsolete" limit line segments 2k+1, ..., 2s
 - updates odd limit line segments 1, 3, ..., 2s-1 with type=upper and the given response values

- creates upper limit line segments $2s+1, 2s+3, \dots, 2k-1$ with (type=upper and) the given response values
- creates "missing" lower limit line segments $2s+2, 2s+4, \dots, 2k$ with (type=lower and) default response values

If $s > 0$, newly created lower/upper limit line segments inherit their start and stop stimuli from the limit line segment with the highest even/odd number. Otherwise their stimulus range is set to the entire sweep range.

See `CALCulate<Chn>:LIMit:CONTRol[:DATA]` on how to change the stimulus values of a limit line segment.

Suffix:

<Chn> Channel number used to identify the active trace

Parameters:

<StartResponse>, <StopResponse>, ... Pair(s) of response values. In the parameter list, item $2s-1$ defines the "Start Response" and item $2s$ defines the "Stop Response" of upper/lower limit line segment $s = 1, 2, \dots$. An odd number of values is rejected with an error message -109, "Missing parameter...".

Range: Virtually no restriction for limit segments.

*RST: Implicitly created segments are created with a default response value of -40dB.

Default unit: dB

Example:

```
CALC:LIM:LOW -10, 0, 0, -10
```

Define two limit line segments covering the entire sweep range. Two upper limit line segments with default response values are created in addition.

```
CALC:LIM:UPP 0, 10, 10, 0
```

Change the response values of the upper limit line segments .

```
CALC:LIM:DISP ON
```

Show the limit line segments in the active diagram.

Manual operation: See "[Segment List](#)" on page 416

```
CALCulate<Chn>:LIMit:LOWer:FEED <StimulusOffset>, <ResponseOffset>[, <TraceName>]
```

```
CALCulate<Chn>:LIMit:UPPer:FEED <StimulusOffset>, <ResponseOffset>[, <TraceName>]
```

Generates a lower or an upper limit line using the stimulus values of a data or memory trace and specified offset values.

Suffix:

<Chn> Channel number used to identify the active trace. This trace provides the stimulus data for the limit line unless another trace <TraceName> is specified.

Setting parameters:

- <StimulusOffset> Stimulus offset value, used to shift all imported limit line segments in horizontal direction.
Default unit: NN
- <ResponseOffset> Response offset value, used to shift all imported limit line segments in vertical direction.
Default unit: dB
- <TraceName> Name of the selected trace as used e.g. in `CALCulate<Ch>:PARAmeter:SDEFine`. If no trace name is specified the analyzer uses the active trace no. <Chn>.

Example:

```
CALC:LIM:LOW:FEED 1 GHZ, -10
```

Use the stimulus values of the active trace, shifted by 1 GHz to the right and decreased by -10 dB, to create a lower limit line.

```
CALC:LIM:UPP:FEED 1 GHZ, 10
```

Use the stimulus values of the active trace, shifted by 1 GHz to the right and increased by 10 dB, to create an upper limit line.

```
CALC:LIM:LOW:SHIF -3; :CALC:LIM:CONT:SHIF 1 GHZ
```

Shift the lower limit line by an additional -3 dB in vertical and by 1 GHz in horizontal direction. The upper limit line is also shifted.

Usage: Setting only

Manual operation: See "[Segment List](#)" on page 416

```
CALCulate<Chn>:LIMit:LOWer:SHIFt <LimShift>
```

```
CALCulate<Chn>:LIMit:UPPer:SHIFt <LimShift>
```

These commands shift all lower and upper limit line segments assigned to the active trace in vertical direction. Both commands shift **all** limit lines; they have the same functionality. See also [Chapter 9.4.1.1, "Rules for Limit Line Definition"](#), on page 232.

Suffix:

<Chn> Channel number used to identify the active trace

Setting parameters:

<LimShift> Response offset value for all limit line segments.
Range: Virtually no restriction for limit segments
Default unit: NN

Example: See `CALCulate<Chn>:LIMit:LOWer:FEED`

Usage: Setting only

Manual operation: See "[Shift Lines](#)" on page 415

CALCulate<Chn>:LIMit:SEGMent<Seg>:AMPLitude:STARt <Response>

CALCulate<Chn>:LIMit:SEGMent<Seg>:AMPLitude:STOP <Response>

These commands change the start or the stop response values (i.e. the response values assigned to the start or stop stimulus values) of a limit line segment. A segment must be created first to enable the commands (e.g. `CALCulate<Chn>:LIMit:DATA`). See also [Chapter 9.4.1.1, "Rules for Limit Line Definition"](#), on page 232.

Tip: To define the response values of several limit line segments with a single command, use `CALCulate<Chn>:LIMit:LOWer[:DATA]` or `CALCulate<Chn>:LIMit:UPPer[:DATA]`.

Suffix:

<Chn> Channel number used to identify the active trace

<Seg> Segment number

Parameters:

<Response> Response value

Range: Virtually no restriction for limit segments

*RST: The default response values of a segment that is created by defining its stimulus values only (e.g. by means of `CALCulate<Ch>:LIMit:CONTRol[:DATA]`), are -40 dB.

Default unit: NN

Example:

```
CALC:LIM:DATA 1,1500000000, 2000000000,2,3
```

Define an upper limit line segment (segment no. 1) in the stimulus range between 1.5 GHz and 2 GHz, assigning response values of +2 dB and +3 dB.

```
:CALC:LIM:SEGM:AMPL:STAR 5; STOP 5; :CALC:LIM:SEGM:TYPE LMIN
```

Change the segment to a lower limit line segment with a constant response value of +5 dB.

```
CALC:LIM:DATA?
```

Query the type, the stimulus and response values of the created segment with a single command. The response is 2,1500000000,2000000000,5,5.

Manual operation: See ["Segment List"](#) on page 416

CALCulate<Chn>:LIMit:SEGMent:COUNT?

Returns the number of limit line segments, including enabled and disabled segments.

Suffix:

<Chn> Channel number used to identify the active trace

- Example:** `CALC:LIM:DATA 1,1500000000, 2000000000,2,3`
 Define an upper limit line segment (segment no. 1) in the stimulus range between 1.5 GHz and 2 GHz, assigning response values of +2 dB and +3 dB.
`CALC:LIM:SEGM:COUNT?`
 Query the number of segments. The response is 1.
- Usage:** Query only
- Manual operation:** See "[Segment List](#)" on page 416

CALCulate<Chn>:LIMit:SEGMENT<Seg>:FORMula <Formula>

Defines a custom formula for limit line segment <Seg> of the related trace.

The formula is only used, if `CALCulate<Chn>:LIMit:SEGMENT<Seg>:FORMula` is set to ON.

Suffix:

- <Chn> Channel number used to identify the active trace
- <Seg> Segment number

Parameters:

- <Formula> User-defined formula (string).
 Allows for the same mathematical expressions as `CALCulate<Chn>:MATH[:EXPRession]:SDEFine`.

- Example:**
- ```
*RST
SENS:FREQ:STAR 1GHz
SENS:FREQ:STOP 3GHz
CALC:LIM:CONT 1GHz, 2GHz, 2GHz, 3GHz
CALC:LIM:SEGM1:FORM '22-(20/25.78)*StimVal/1e9'
CALC:LIM:SEGM1:FORM:STAT ON
CALC:LIM:SEGM2:FORM '15-(6/25.78)*StimVal/1e9'
CALC:LIM:SEGM2:TYPE LMIN
CALC:LIM:DISP ON
CALC:LIM:STAT ON
```

- Manual operation:** See "[Linear/Formula](#)" on page 419

### **CALCulate<Chn>:LIMit:SEGMENT<Seg>:FORMula:STATe <State>**

Defines whether a custom formula is used for limit line segment <Seg> of the related trace.

**Suffix:**

- <Chn> Channel number used to identify the active trace

<Seg> Segment number  
 If you want to use a custom formula for a segment, use `CALCulate<Chn>:LIMit:CONTRol[:DATA]` to create it.

**Parameters:**

<State> **OFF (0)**  
 The line segment is a straight line, connecting the endpoints specified in the segment definition.

**ON (1)**  
 The line segment is defined by a custom formula. Use `CALCulate<Chn>:LIMit:SEGMENT<Seg>:FORMula` to specify the formula.

\*RST: OFF

**Example:** See `CALCulate<Chn>:LIMit:SEGMENT<Seg>:FORMula` on page 629

**Manual operation:** See "[Linear/Formula](#)" on page 419

**CALCulate<Chn>:LIMit:SEGMENT<Seg>:INTERpol <LimLineInterpolation>**

"Interpolation" determines whether the limit line segment is interpolated linearly or logarithmically. The latter may be more suitable for logarithmic sweeps.

**Suffix:**

<Chn> Channel number used to identify the active trace

<Seg> Segment number

**Parameters:**

<LimLineInterpolation> LOGarithmic | LINear

**Manual operation:** See "[Segment List](#)" on page 416

**CALCulate<Chn>:LIMit:SEGMENT<Seg>:STIMulus:START <FreqPowTime>****CALCulate<Chn>:LIMit:SEGMENT<Seg>:STIMulus:STOP <StimVal>**

These commands change the start and stop stimulus values (i.e. the smallest and the largest stimulus values) of a limit line segment. A segment must be created first to enable the commands (e.g. `CALCulate<Chn>:LIMit:DATA`). See also [Chapter 9.4.1.1, "Rules for Limit Line Definition"](#), on page 232.

**Tip:** To define the stimulus values of several limit line segments with a single command, use `CALCulate<Chn>:LIMit:CONTRol[:DATA]`.

**Suffix:**

<Chn> Channel number used to identify the active trace

<Seg> Segment number

**Parameters:**

&lt;StimVal&gt;

Stimulus value confining the limit line segment.

If specified, the unit of a stimulus value must in accordance with the sweep type of the active channel (`[SENSe<Ch>:]SWEep:TYPE`). Default units are *Hz* for frequency sweeps, and *s* for time sweeps. For CW mode sweeps, stimulus values are dimensionless.

Default unit: NN

**Example:**

```
CALC:LIM:DATA 1,1500000000, 2000000000,2,3
```

Define an upper limit line segment (segment no. 1) in the stimulus range between 1.5 GHz and 2 GHz, assigning response values of +2 dB and +3 dB.

```
CALC:LIM:SEGM:STIM:STAR 1GHZ; STOP 2 GHZ; :
```

```
CALC:LIM:SEGM:TYPE LMIN
```

Change the segment to a lower limit line segment with a stimulus range between 1 GHz and 2 GHz.

```
CALC:LIM:DATA?
```

Query the type, the stimulus and response values of the created segment with a single command. The response is 2,1000000000,2000000000,2,3.

**Manual operation:** See "[Segment List](#)" on page 416

---

**CALCulate<Chn>:LIMit:SEGment<Seg>:TYPE <LimLineType>**

Selects the limit line type for a limit line segment. This can be done before or after defining the stimulus and response values of the segment, however, a segment must be created first to enable this command (e.g `CALC:LIM:DATA`).

**Note:** The type command overwrites the `CALCulate<Chn>:LIMit:DATA` settings and is overwritten by them. It is not affected by the other commands in the `CALCulate<Chn>:LIMit...` subsystem defining stimulus and response values of limit lines.

**Suffix:**

&lt;Chn&gt;

Channel number used to identify the active trace

&lt;Seg&gt;

Segment number

**Parameters:**

&lt;LimLineType&gt;

LMIN | LMAX | OFF

Limit line type

Range: LMAX (upper limit line segment), LMIN (lower limit line segment), OFF (limit check switched off, limit line segment not deleted)

\*RST: LMAX

**Example:** `*RST; :CALC:LIM:UPP 0, 0`  
 Define an upper limit line segment across the entire sweep range, using a constant upper limit of 0 dBm.  
`CALC:LIM:SEGM:TYPE LMIN`  
 Turn the defined limit line segment into a lower limit line segment.

**Manual operation:** See "[Segment List](#)" on page 416

#### **CALCulate<Chn>:LIMit:SOUND[:STATe] <Boolean>**

Switches the acoustic signal (fail beep) on or off. The fail beep is generated each time the analyzer detects an exceeded limit.

**Suffix:**  
 <Chn> Channel number used to identify the active trace

**Parameters:**  
 <Boolean> ON | OFF - Fail beep on or off.  
 \*RST: OFF

**Example:** `CALC:LIM:STAT ON; SOUN ON`  
 Switch the limit check on and activate the fail beep.

**Manual operation:** See "[Limit Fail Beep](#)" on page 413

#### **CALCulate<Chn>:LIMit:STATe <Boolean>**

Switches the limit check (including upper and lower limits) on or off.

**Tip:** Use `CALCulate<Ch>:LIMit:UPPer:STATe` or `CALCulate<Ch>:LIMit:LOWer:STATe` to switch on or off the individual limit checks for upper or lower limit lines.

**Suffix:**  
 <Chn> Channel number used to identify the active trace

**Parameters:**  
 <Boolean> ON | OFF - Limit check on or off.  
 \*RST: OFF

**Example:** `*RST; CALC:LIM:CONT 1 GHZ, 2 GHZ`  
 Define an upper limit line segment in the stimulus range between 1 GHz and 2 GHz, using default response values.  
`CALC:LIM:STAT ON; FAIL?`  
 Switch the limit check on and query the result.

**Manual operation:** See "[Limit Check](#)" on page 412

#### **CALCulate<Chn>:LIMit:STATe:AREA <HorizontalPos>, <VerticalPos>**

Moves the limit check pass/fail message for the active trace <Chn> to one of nine pre-defined positions in the active diagram.



**Suffix:**  
 <Chn> Channel number used to identify the active trace

**Parameters:**  
 <HorizontalPos> LEFT | MID | RIGHT  
 Horizontal position  
 <VerticalPos> TOP | MID | BOTTOm  
 Vertical position

**Example:** See [CALCulate<Chn>:LIMit:FAIL?](#)

**Manual operation:** See "[Limit Check](#)" on page 412

### **CALCulate<Chn>:LIMit:TTLout<Pt>[:STATe] <Boolean>**

Switches the TTL pass/fail signals on or off. The signals are applied to the USER PORT as long as the active trace <Chn> is within limits, including the ripple limits.

- See [Chapter 15.3.1.1, "Aux. Port"](#), on page 1014
- Because the Aux. Port is not available for the R&S ZNLE, this command is not available for these instruments.

**Suffix:**  
 <Chn> Channel number used to identify the active trace  
 <Pt> 1 - TTL out pass 1 (pin 13 of Aux. Port connector)  
 2 - TTL out pass 2 (pin 14 of Aux. Port connector)

**Parameters:**  
 <Boolean> ON | OFF - TTL output signal on or off.  
 \*RST: OFF

**Example:** \*RST; :CALC:LIM:CONT 1 GHZ, 2 GHZ  
 Define an upper limit line segment in the stimulus range between 1 GHz and 2 GHz, using default response values.  
 CALC:LIM:STAT ON; TTL2 ON  
 Switch the limit check on and activate the TTL out pass 2 signal.

**Manual operation:** See "[TTL1 Pass / TTL2 Pass](#)" on page 414

### **CALCulate:MARKer...**

The CALCulate:MARKer... commands control the marker functions. The commands are device-specific and beyond what is specified in the SCPI subsystem SOURCE:MARKer....

|                                                                         |     |
|-------------------------------------------------------------------------|-----|
| <a href="#">CALCulate:MARKer:COUPled[:STATe]</a> .....                  | 634 |
| <a href="#">CALCulate:MARKer:COUPled:TYPE</a> .....                     | 635 |
| <a href="#">CALCulate:MARKer:FUNcTION:BWIDth:GMCenter</a> .....         | 635 |
| <a href="#">CALCulate&lt;Chn&gt;:MARKer[:STATe]:AREA</a> .....          | 636 |
| <a href="#">CALCulate&lt;Chn&gt;:MARKer:DEFault:FORMat</a> .....        | 636 |
| <a href="#">CALCulate&lt;Chn&gt;:MARKer:MPEak:EXcursion</a> .....       | 637 |
| <a href="#">CALCulate&lt;Chn&gt;:MARKer:MPEak:EXcursion:STATe</a> ..... | 638 |

|                                                               |     |
|---------------------------------------------------------------|-----|
| CALCulate<Chn>:MARKer:MPEak:THReshold.....                    | 638 |
| CALCulate<Chn>:MARKer:MPEak:THReshold:STATe.....              | 638 |
| CALCulate<Chn>:MARKer:SEARch:BFILter:RESult[:STATe].....      | 639 |
| CALCulate<Chn>:MARKer:SEARch:BFILter:RESult[:STATe]:AREA..... | 639 |
| CALCulate<Chn>:MARKer<Mk>:AOFF.....                           | 639 |
| CALCulate<Chn>:MARKer<Mk>:BWIDth.....                         | 640 |
| CALCulate<Chn>:MARKer<Mk>:DELTA[:STATe].....                  | 641 |
| CALCulate<Chn>:MARKer<Mk>:EXCursion.....                      | 641 |
| CALCulate<Chn>:MARKer<Mk>:EXCursion:STATe.....                | 642 |
| CALCulate<Chn>:MARKer<Mk>:FORMat.....                         | 642 |
| CALCulate<Chn>:MARKer<Mk>:FUNction:BWIDth:MODE.....           | 643 |
| CALCulate<Chn>:MARKer<Mk>:FUNction:CENter.....                | 643 |
| CALCulate<Chn>:MARKer<Mk>:FUNction:DOMain:USER[:RANGe].....   | 644 |
| CALCulate<Chn>:MARKer<Mk>:FUNction:DOMain:USER:SHOW.....      | 644 |
| CALCulate<Chn>:MARKer<Mk>:FUNction:DOMain:USER:START.....     | 645 |
| CALCulate<Chn>:MARKer<Mk>:FUNction:DOMain:USER:STOP.....      | 645 |
| CALCulate<Chn>:MARKer<Mk>:FUNction:EXECute.....               | 645 |
| CALCulate<Chn>:MARKer<Mk>:FUNction:RESult?.....               | 646 |
| CALCulate<Chn>:MARKer<Mk>:FUNction:SPAN.....                  | 646 |
| CALCulate<Chn>:MARKer<Mk>:FUNction:START.....                 | 647 |
| CALCulate<Chn>:MARKer<Mk>:FUNction:STOP.....                  | 647 |
| CALCulate<Chn>:MARKer<Mk>:MODE.....                           | 647 |
| CALCulate<Chn>:MARKer<Mk>:NAME.....                           | 648 |
| CALCulate<Chn>:MARKer<Mk>:REFerence[:STATe].....              | 648 |
| CALCulate<Chn>:MARKer<Mk>:REFerence:FORMat.....               | 649 |
| CALCulate<Chn>:MARKer<Mk>:REFerence:MODE.....                 | 649 |
| CALCulate<Chn>:MARKer<Mk>:REFerence:NAME.....                 | 650 |
| CALCulate<Chn>:MARKer<Mk>:REFerence:TYPE.....                 | 650 |
| CALCulate<Chn>:MARKer<Mk>:REFerence:X.....                    | 651 |
| CALCulate<Chn>:MARKer<Mk>:REFerence:Y.....                    | 652 |
| CALCulate<Chn>:MARKer<Mk>:SEARch:TRACKing.....                | 652 |
| CALCulate<Chn>:MARKer<Mk>:SEARch:FORMat.....                  | 653 |
| CALCulate<Chn>:MARKer<Mk>[:STATe].....                        | 654 |
| CALCulate<Chn>:MARKer<Mk>:TARGeT.....                         | 655 |
| CALCulate<Chn>:MARKer<Mk>:THReshold.....                      | 655 |
| CALCulate<Chn>:MARKer<Mk>:THReshold:STATe.....                | 655 |
| CALCulate<Chn>:MARKer<Mk>:TYPE.....                           | 656 |
| CALCulate<Chn>:MARKer<Mk>:X.....                              | 657 |
| CALCulate<Chn>:MARKer<Mk>:Y.....                              | 658 |

---

### **CALCulate:MARKer:COUPled[:STATe]** <Boolean>

Enables marker coupling to the active trace of the active channel or disables it.

Use `CALCulate:MARKer:COUPled:TYPE` to select the suitable coupling type before setting `CALCulate:MARKer:COUPled:STATe` to ON.

#### **Parameters:**

<Boolean>                    ON | OFF - enables or disables marker coupling.  
                                  \*RST:            OFF

**Example:** Suppose that the active channel setup contains traces Trc1 and Trc2, assigned to channels no. 1 and 2, respectively.

```
:CALC2:PAR:SEL 'TRC2'; :CALC2:MARK1 ON; MARK2 ON
```

Select Trc2 as the active trace of channel 2 and activate markers 1 and 2 for it. The default position for both markers is the center of the sweep range.

```
INSTRUMENT:NSELECT 2
```

Make channel 2 the active channel.

```
CALCulate:MARKer:COUPled:TYPE ALL
```

Select coupling type "All" (channel setup-wide coupling).

```
CALC:MARK:COUP ON
```

Activate marker coupling to Trc2 (the active trace of the active channel). Automatically creates markers no. 1 and 2 on Trc1 and couples them to the respective markers of Trc2.

**Manual operation:** See "[Coupled Markers](#)" on page 432

#### **CALCulate:MARKer:COUPled:TYPE** <Type>

Selects the marker coupling type to be used in the current channel setup.

Marker coupling is enabled using `CALCulate:MARKer:COUPled[:STATe] ON`.

Changing the coupling type automatically disables marker coupling throughout the channel setup.

#### **Parameters:**

<Type> ALL | CHANnel | DIAGram

Marker coupling mode

#### **ALL**

channel setup-wide

#### **CHANnel**

channel-wide

#### **DIAGram**

diagram-wide

**Example:** See `CALCulate:MARKer:COUPled[:STATe]` on page 634

**Manual operation:** See "[Coupling Type](#)" on page 437

#### **CALCulate:MARKer:FUNction:BWIDth:GMCenter** <arg0>

Defines how bandfilter searches calculate the center frequency of the passband or stopband.

#### **Parameters:**

<arg0>

**ON** – use **geometric** mean of lower and upper band edge

**OFF** – use **arithmetic** mean

\*RST: n/a (\*RST does not affect the calculation rule; the factory setting is ON/geometric mean)

**Manual operation:** See ["Geometric Calculation of Bandfilter Center"](#) on page 145

---

**CALCulate<Chn>:MARKer[:STATe]:AREA** <HorizontalPos>, <VerticalPos>

Moves the marker info field for the active trace <Chn> to one of nine predefined positions in the active diagram.

**Suffix:**

<Chn> Channel number used to identify the active trace

**Parameters:**

<HorizontalPos> LEFT | MID | RIGHT  
Horizontal position

<VerticalPos> TOP | MID | BOTTOm  
Vertical position

**Example:** See [CALCulate<Chn>:MARKer<Mk>:Y](#)

**Manual operation:** See ["Mkr 1 ... Mkr 10"](#) on page 431

---

**CALCulate<Chn>:MARKer:DEFault:FORMat** <OutFormat>

Defines the default marker format of the selected channel's active trace.

New markers will be formatted with the default marker format; previously existing markers will be reformatted if (and only if) their marker format is set to (Trace) DEFault (using [CALCulate<Chn>:MARKer<Mk>:FORMat](#)).

**Suffix:**

<Chn> Channel number used to identify the active trace

**Parameters:**

<OutFormat> MLINear | MLOGarithmic | PHASe | POLar | GDELay | REAL | IMAGinary | SWR | LINPhase | LOGPhase | IMPedance | ADMittance | DEFault | COMPLex | MDB | MLPPhase | MDPHase | MIMPedance | PIMPedance | PADmittance | MADmittance | MPIMPedance | MPADmittance | INDX

DEFault means the default marker format is dynamically adjusted to the selected trace format ([CALCulate<Chn>:FORMat](#)).

For the other marker formats see the table below and the description in ["Marker Format"](#) on page 201.

\*RST: DEFault

**Manual operation:** See ["Dflt Marker Frmt"](#) on page 401

| SCPI                                            | GUI       |
|-------------------------------------------------|-----------|
| MLINear                                         | "Lin Mag" |
| MLOGarithmic<br>MDB (for R&S ZVR compatibility) | "dB Mag"  |

| SCPI                                            | GUI                                                                                                    |
|-------------------------------------------------|--------------------------------------------------------------------------------------------------------|
| PHASe                                           | "Phase"                                                                                                |
| POLar<br>COMPLex (for R&S ZVR compatibility)    | "Real Imag"                                                                                            |
| GDELay                                          | "Delay"                                                                                                |
| REAL                                            | "Real"                                                                                                 |
| IMAGinary                                       | "Imag"                                                                                                 |
| SWR                                             | "SWR"                                                                                                  |
| LINPhase<br>MLPhase (for R&S ZVR compatibility) | "Lin Mag Phas"e                                                                                        |
| LOGPhase<br>MDPhase (for R&S ZVR compatibility) | "dB Mag Phase"                                                                                         |
| IMPedance                                       | "R + j X" for reflection measurement traces<br>"R + j X series" for transmission measurement traces    |
| PIMPedance                                      | "R + j X", for reflection measurement traces<br>"R + j X parallel" for transmission measurement traces |
| ADMittance                                      | "G + j B" for reflection measurement traces<br>"G + j B series" for transmission measurement traces    |
| PADMittance                                     | "G + j B" for reflection measurement traces<br>"G + j B parallel" for transmission measurement traces  |
| MIMPedance                                      | "Imp Mag" for reflection measurement traces<br>"Imp Mag series" for transmission measurement traces    |
| MPIMPedance                                     | "Imp Mag" for reflection measurement traces<br>"Imp Mag parallel" for transmission measurement traces  |
| MADMittance                                     | "Adm Mag" for reflection measurement traces<br>"Adm Mag series" for transmission measurement traces    |
| MPADMittance                                    | "Adm Mag" for reflection measurement traces<br>"Adm Mag parallel" for transmission measurement traces  |
| INDex                                           | Index                                                                                                  |

---

**CALCulate<Chn>:MARKer:MPEak:EXCursion <TargetSearchVal>**

Defines a minimum excursion value for multiple peak searches.

Use `CALCulate<Chn>:MARKer:MPEak:EXCursion:STATe` to activate it.

**Suffix:**

<Chn> Channel number used to identify the active trace

**Parameters:**

<Value> Minimum peak excursion  
The unit is derived from the active trace format and cannot be modified. Changing the trace format resets the excursion to a format-specific default value.

**Manual operation:** See "[Excursion Settings](#)" on page 445

**CALCulate<Chn>:MARKer:MPEak:EXCursion:STATe <Boolean>**

Activates or deactivates the minimum excursion for multiple peak searches.

Use `CALCulate<Chn>:MARKer:MPEak:EXCursion` to set the minimum peak excursion.

**Suffix:**

<Chn> Channel number used to identify the active trace

**Parameters:**

<Active> Boolean

**Manual operation:** See "[Excursion Settings](#)" on page 445

**CALCulate<Chn>:MARKer:MPEak:THReshold <Value>**

Defines a threshold value for multiple peak searches.

Use `CALCulate<Chn>:MARKer:MPEak:THReshold:STATe` to activate it.

**Suffix:**

<Chn> Channel number used to identify the active trace

**Parameters:**

<Value> Threshold value  
The unit is derived from the active trace format and cannot be modified. Changing the trace format resets the threshold to a format-specific default value.

**Manual operation:** See "[Threshold Settings](#)" on page 445

**CALCulate<Chn>:MARKer:MPEak:THReshold:STATe <Boolean>**

Activates or deactivates the threshold for multiple peak searches.

Use `CALCulate<Chn>:MARKer:MPEak:THReshold` to set the threshold value.

**Suffix:**

<Chn> Channel number used to identify the active trace

**Parameters:**

<Active> Boolean

**Manual operation:** See ["Threshold Settings"](#) on page 445

**CALCulate<Chn>:MARKer:SEARch:BFILter:RESult[:STATe] <Boolean>**

Shows or hides the bandfilter search results in the diagram area.

**Suffix:**

<Chn> Channel number used to identify the active trace

**Parameters:**

<Boolean> ON - show the bandfilter search results. If no bandfilter search has been initiated before (`CALCulate<Chn>:MARKer<Mk>:FUNCTION:EXECute BFILter`), nothing is displayed.  
OFF - hide the bandfilter search results.

\*RST: OFF

**Example:** See `CALCulate<Chn>:MARKer<Mk>:BWIDth`

**Manual operation:** See ["Result Off"](#) on page 451

**CALCulate<Chn>:MARKer:SEARch:BFILter:RESult[:STATe]:AREA  
<HorizontalPos>, <VerticalPos>**

Moves the bandfilter search info field for the active trace <Chn> to one of nine predefined positions in the active diagram.

**Suffix:**

<Chn> Channel number used to identify the active trace

**Parameters:**

<HorizontalPos> LEFT | MID | RIGHT  
Horizontal position

<VerticalPos> TOP | MID | BOTTom  
Vertical position

**Example:** See `CALCulate<Chn>:MARKer<Mk>:BWIDth`

**Manual operation:** See ["Bandpass Ref to Max"](#) on page 449

**CALCulate<Chn>:MARKer<Mk>:AOFF**

Removes all markers from all traces of the active channel setup. The removed markers remember their properties (stimulus value, format, delta mode, number) when they are restored (`CALCulate<Chn>:MARKer<Mk>[:STATe] ON`). The marker properties are definitely lost if the associated trace is deleted.

**Suffix:**

<Chn> Channel number used to identify the active trace. If unspecified the numeric suffix is set to 1.

|                          |                                                                                                                                                                                                                                    |
|--------------------------|------------------------------------------------------------------------------------------------------------------------------------------------------------------------------------------------------------------------------------|
| <Mk>                     | This numeric suffix is ignored and may be set to any value.                                                                                                                                                                        |
| <b>Example:</b>          | Suppose that the active channel setup contains an active trace no. 1.<br><code>CALC:MARK1 ON; MARK2 ON</code><br>Create markers 1 and 2 and assign them to the trace no. 1.<br><code>CALC:MARK:AOFF</code><br>Remove both markers. |
| <b>Usage:</b>            | Event                                                                                                                                                                                                                              |
| <b>Manual operation:</b> | See "All Off" on page 431                                                                                                                                                                                                          |

---

### **CALCulate<Chn>:MARKer<Mk>:BWIDth <Bandwidth>**

Sets the bandfilter level for a bandfilter search or returns the results. The command is only available after a bandfilter search has been executed (`CALCulate<Chn>:MARKer<Mk>:FUNCTION:EXECute BFIlter`; see example below).

The response to the query `CALCulate<Chn>:MARKer<Mk>:BWIDth?` contains the following bandfilter search results:

- <Bandwidth> – bandwidth of the bandpass/bandstop region.
- <Center> – stimulus frequency at the center of the bandpass/bandstop region (the stimulus value of marker M4).
- <QualityFactor (3 dB)> – quality factor, i.e. the ratio between the center frequency and the 3-dB bandwidth.
- <Loss> – loss at the center of the bandpass/bandstop region (the response value of marker M4 at the time of the bandfilter search).
- <LowerEdge> – lower band edge.
- <UpperEdge> – upper band edge.

**Tip:** To obtain the <Quality Factor (BW)> result from the bandfilter info field, calculate the ratio <Center> / <Bandwidth>.

#### **Suffix:**

|       |                                                                                                                                 |
|-------|---------------------------------------------------------------------------------------------------------------------------------|
| <Chn> | Channel number used to identify the active trace                                                                                |
| <Mk>  | This numeric suffix is ignored and may be set to any value because the bandfilter search functions always use markers M1 to M4. |

#### **Parameters:**

|               |                                                                                                                                                                  |
|---------------|------------------------------------------------------------------------------------------------------------------------------------------------------------------|
| <Bandwidth>   | Difference between the band edges and the center response value of a bandfilter peak; must be negative for a bandpass search and positive for a bandstop search. |
| Range:        | For bandpass: -100.00 dB to -0.01 dB; for bandstop: +0.01 dB to +100.00 dB                                                                                       |
| Increment:    | 0.03 dB                                                                                                                                                          |
| *RST:         | -3 dB                                                                                                                                                            |
| Default unit: | dB                                                                                                                                                               |



**Example:**

```
CALC:MARK:FUNC:BWID:MODE BST
Select a bandstop filter search.
CALC:MARK:FUNC:EXEC BFIL
Initiate the bandpass filter search for the current trace. Create
markers M1 to M4.
CALC:MARK:SEAR:BFIL:RES ON
Display the marker info field in the diaram area.
CALC:MARK:BWID 6
Select a 6-dB bandwidth for the bandstop.
CALC:MARK:BWID?
Query the results of the bandfilter search. An error message is
generated if the bandfilter search fails so that no valid results are
available.
CALC:MARK:SEAR:BFIL:RES:AREA LEFT, TOP
For a subsequent check at the GUI or a hardcopy, move the info
field to the top left position.
```

**Manual operation:** See "[Bandwidth](#)" on page 448

#### **CALCulate<Chn>:MARKer<Mk>:DELTA[:STATe] <Boolean>**

Switches the delta mode for marker <Mk> on trace no. <Chn> on or off. The marker must be created before using `CALCulate<Chn>:MARKer<Mk>[:STATe] ON`. If the active trace contains no reference marker, the command also creates a reference marker.

**Suffix:**

<Chn> Channel number used to identify the active trace  
 <Mk> Marker number.

**Parameters:**

<Boolean> ON | OFF - Enables or disables the delta mode.  
 \*RST: OFF

**Example:**

```
Suppose that the active channel setup contains an active trace
no. 1.
CALC:MARK ON
Create marker no. 1 and set it to the center of the sweep range.
CALC:MARK:DELT ON
Create a reference marker at the center of the sweep range and
set marker 1 to delta mode.
```

**Manual operation:** See "[Delta Mode](#)" on page 431

#### **CALCulate<Chn>:MARKer<Mk>:EXCURsion <Value>**

Defines a marker-specific minimum excursion value for peak searches.

Use `CALCulate<Chn>:MARKer<Mk>:EXCURsion:STATe` to activate it.

**Suffix:**

<Chn> Channel number used to identify the active trace

<Mk> Marker number

**Parameters:**

<Value> Minimum peak excursion  
The unit is derived from the active trace format and cannot be modified. Changing the trace format resets the excursion to a format-specific default value.

**Manual operation:** See "[Excursion Settings](#)" on page 443

**CALCulate<Chn>:MARKer<Mk>:EXCursion:STATe <Boolean>**

Activates or deactivates the marker-specific minimum excursion for peak searches.

Use [CALCulate<Chn>:MARKer<Mk>:EXCursion](#) to set the minimum peak excursion.

**Suffix:**

<Chn> Channel number used to identify the active trace

<Mk> Marker number

**Parameters:**

<Active> Boolean

**Manual operation:** See "[Excursion Settings](#)" on page 443

**CALCulate<Chn>:MARKer<Mk>:FORMat <OutFormat>**

Sets/queries the output format for the (complex) value of the related marker.

**Suffix:**

<Chn> Channel number used to identify the active trace

<Mk> Marker number.

**Parameters:**

<OutFormat> MLINear | MLOGarithmic | PHASe | POLar | GDELay | REAL | IMAGinary | SWR | LINPhase | LOGPhase | IMPedance | ADMittance | DEFault | COMPLex | MDB | MLPHase | MDPHase | MIMPedance | PIMPedance | PADmittance | MADmittance | MPIMPedance | MPADmittance | INDX  
DEFault means that the marker is formatted according to the related trace's default marker format (see [CALCulate<Chn>:MARKer:DEFault:FORMat](#)), which may not be set to DEFault (= trace format).  
For the other marker formats, see [CALCulate<Chn>:MARKer:DEFault:FORMat](#) and the description in "[Marker Format](#)" on page 201.  
\*RST: DEFault

**Manual operation:** See "[Marker Format](#)" on page 433

**CALCulate<Chn>:MARKer<Mk>:FUNCtion:BWIDth:MODE <BandfilterType>**

Selects the bandfilter search mode. In contrast to manual control, bandfilter tracking is not automatically activated.

**Suffix:**

<Chn> Channel number used to identify the active trace

<Mk> This numeric suffix is ignored and may be set to any value because the bandfilter search functions always use markers M1 to M4.

**Parameters:**

<BandfilterType> BPASs | BStOp | BPRMarker | BSRMarker | BPABsolute | BSABsolute | NONE

Bandfilter search type:

BPASs – Bandpass Search Ref to Max

BStOp – Bandstop Search Ref to Max

BPRMarker – Bandpass Search Ref to Marker

BSRMarker – Bandstop Search Ref to Marker

BPABsolute – Bandpass Absolute Level

BSABsolute – Bandstop Absolute Level

NONE – deactivate bandfilter search, result off

\*RST: NONE

**Example:** See [CALCulate<Chn>:MARKer<Mk>:BWIDth](#)

**Manual operation:** See "[Bandpass Ref to Max](#)" on page 449

**CALCulate<Chn>:MARKer<Mk>:FUNCtion:CENTer**

Sets the center of the sweep range equal to the stimulus value of the marker <Mk> on trace no. <Chn>.

**Suffix:**

<Chn> Channel number used to identify the active trace

<Mk> Marker number.

**Example:**

\*RST; :CALC:MARK ON

Create marker 1 in the center of the current sweep range and assign it to trace no. 1.

CALC:MARK:FUNC:CENT

Leave the sweep range unchanged.

**Usage:** Event

**Manual operation:** See "[Center = Marker / Start = Marker / Stop = Marker / Span = Marker](#)" on page 435

---

**CALCulate<Chn>:MARKer<Mk>:FUNcTion:DOMain:USER[:RANGe]**  
 <NumSearchRange>

Assigns a search range no. <NumSearchRange> to marker no <Mk> and selects the search range, e.g. in order to display range limit lines or define the start and stop values.

**Suffix:**

<Chn> Channel number used to identify the active trace

<Mk> Marker number.

**Parameters:**

<NumSearchRange> Number of the search range.

Range: 0 to 10 where 0 refers to the fixed full span search range (equal to the sweep range) and 1 to 10 refer to user-definable search ranges; see example.

\*RST: 0 (reserved for full span search range)

**Example:**

CALC1:MARK1:FUNC:DOM:USER 2

Select the search range no. 2, assigned to marker no. 1 and trace no. 1.

CALC:MARK:FUNC:DOM:USER:START 1GHz

Set the start frequency of the search range to 1 GHz.

CALC:MARK:FUNC:DOM:USER:STOP 1.2GHz

Set the stop frequency of the search range to 1.2 GHz.

**Manual operation:** See "[Search Range](#)" on page 441

---

**CALCulate<Chn>:MARKer<Mk>:FUNcTion:DOMain:USER:SHOW <Boolean>**

Displays or hides range limit lines for the search range selected via [CALCulate<Chn>:MARKer<Mk>:FUNcTion:DOMain:USER\[:RANGe\]](#).

**Suffix:**

<Chn> Channel number used to identify the active trace

<Mk> Marker number.

**Parameters:**

<Boolean> ON | OFF - range limit lines on or off.

\*RST: OFF

**Example:**

See [CALCulate<Chn>:STATistics:DOMain:USER](#)

**Manual operation:** See "[Range Limit Lines On](#)" on page 442

---

**CALCulate<Chn>:MARKer<Mk>:FUNCtion:DOMain:USER:START**  
 <StarSearchRange>

**CALCulate<Chn>:MARKer<Mk>:FUNCtion:DOMain:USER:STOP**  
 <StopSearchRange>

These commands define the start and stop values of the search range selected via [CALCulate<Chn>:MARKer<Mk>:FUNCtion:DOMain:USER\[:RANGE\]](#).

**Suffix:**

<Chn> Channel number used to identify the active trace

<Mk> Marker number.

**Parameters:**

<StopSearchRange> Beginning or end of the search range.

Range: Maximum allowed sweep range, depending on the instrument model and on the sweep type.

Default unit: NN

**Example:**

See [CALCulate<Chn>:MARKer<Mk>:FUNCtion:DOMain:USER\[:RANGE\]](#)

**Manual operation:** See "Search Range" on page 441

---

**CALCulate<Chn>:MARKer<Mk>:FUNCtion:EXECute [<SearchMode>]**

Selects a search mode for marker no. <Mk> and initiates the search. The marker must be created before using [CALCulate<Chn>:MARKer<Mk>\[:STATE\] ON](#) (exception: bandfilter search).

**Suffix:**

<Chn> Channel number used to identify the active trace

<Mk> Marker number. For a bandfilter search ([BFILter](#)) this numeric suffix is ignored and may be set to any value because the bandfilter search functions always use markers M1 to M4.

**Setting parameters:**

<SearchMode> MAXimum | MINimum | RPEak | LPEak | NPEak | TARGet | LTARget | RTARget | BFILter | MMAXimum | MMINimum | SPRogress

See list of parameters below.

**Example:**

Suppose that the active channel setup contains an active trace no. 1.

```
CALC:MARK ON
```

Create marker M1 and assign it to trace no. 1.

```
CALC:MARK:FUNC:EXEC MAX; RES?
```

Move the created marker to the absolute maximum of the trace and query the stimulus and response value of the search result.

**Usage:**

Setting only

**Manual operation:** See "Max / Min" on page 439

The analyzer provides the following search modes:

| Mode                 | Find...                                                                                                                        |
|----------------------|--------------------------------------------------------------------------------------------------------------------------------|
| MAXimum              | Absolute maximum in the search range (see <a href="#">CALCulate&lt;Chn&gt;:MARKer&lt;Mk&gt;:FUNCTION:DOMain:USER[:RANGE]</a> ) |
| MINimum              | Absolute maximum in the search range                                                                                           |
| RPEak                | Next valid peak to the right of the current marker position                                                                    |
| LPEak                | Next valid peak to the left                                                                                                    |
| NPEak                | Next highest or lowest value among the valid peaks (next peak)                                                                 |
| TARGet               | Target value (see <a href="#">CALCulate&lt;Chn&gt;:MARKer&lt;Mk&gt;:TARGet</a> )                                               |
| RTARget              | Next target value to the right of the current marker position                                                                  |
| LTARget              | Next target value to the left                                                                                                  |
| BFILter              | Bandfilter search. The results are queried using <a href="#">CALCulate&lt;Chn&gt;:MARKer&lt;Mk&gt;:BWIDth</a> .                |
| MMAximum or MMINimum | Multiple peak search                                                                                                           |
| SPRogress            | Sweep progress                                                                                                                 |

---

#### **CALCulate<Chn>:MARKer<Mk>:FUNCTION:RESult?**

Returns the result (stimulus and response value) of a search started by means of [CALCulate<Chn>:MARKer<Mk>:FUNCTION:EXECute](#). The search must be executed before the command is enabled.

**Suffix:**

<Chn> Channel number used to identify the active trace

<Mk> This numeric suffix is ignored and may be set to any value.

**Example:** See [CALCulate<Chn>:MARKer<Mk>:FUNCTION:EXECute](#)

**Usage:** Query only

**Manual operation:** See "Max / Min" on page 439

---

#### **CALCulate<Chn>:MARKer<Mk>:FUNCTION:SPAN**

Sets the sweep span of the sweep range equal to the absolute value of the first coordinate of the active delta marker <Mk> on trace no. <Chn>.

**Suffix:**

<Chn> Channel number used to identify the active trace

<Mk> Marker number.

- Example:** `*RST; :CALC:MARK ON; MARK:DELTA ON`  
 Create marker 1 in the center of the current sweep range and enable the delta mode.  
`CALC:MARK:X 300MHZ`  
 Increase the stimulus value of the delta marker by 300 MHz.  
`CALC:MARK:FUNC:SPAN`  
 Set the sweep range equal to 300 MHz. The sweep range starts at the reference marker position, i.e. in the center of the analyzer's frequency range.
- Usage:** Event
- Manual operation:** See "[Center = Marker / Start = Marker / Stop = Marker / Span = Marker](#)" on page 435

**CALCulate<Chn>:MARKer<Mk>:FUNCtion:START**  
**CALCulate<Chn>:MARKer<Mk>:FUNCtion:STOP**

These command sets the beginning (. . .START) and the end (. . .STOP) of the sweep range equal to the stimulus value of the marker <Mk> on trace no. <Chn>.

**Suffix:**

<Chn> Channel number used to identify the active trace

<Mk> Marker number.

- Example:** `*RST; :CALC:MARK ON`  
 Create marker 1 in the center of the current sweep range and assign it to trace no. 1.  
`CALC:MARK:FUNC:STAR`  
 Divide the sweep range in half, starting at the current marker position. As an alternative:  
`CALC:MARK:FUNC:STOP`  
 Divide the sweep range in half, ending at the current marker position.

**Usage:** Event

**Manual operation:** See "[Center = Marker / Start = Marker / Stop = Marker / Span = Marker](#)" on page 435

**CALCulate<Chn>:MARKer<Mk>:MODE <Mode>**

Sets marker no. <Mk> to continuous or discrete mode. The marker doesn't have to be created before (`CALCulate<Chn>:MARKer<Mk>[:STATe] ON`), the mode can be assigned in advance.

**Suffix:**

<Chn> Channel number used to identify the active trace

<Mk> Marker number.

**Parameters:**

<Mode> CONTInuous | DISCcrete  
 CONTInuous - marker can be positioned on any point of the trace, and its response values are obtained by interpolation.  
 DISCcrete - marker can be set to discrete sweep points only.  
 \*RST: CONT

**Example:**

Suppose that the active channel setup contains an active trace no. 1.

```
CALC:MARK:MODE DISC; :CALC:MARK2:MODE CONT
```

Create marker 1 in discrete mode and marker 2 in continuous mode.

```
CALC:MARK ON; MARK2 ON
```

Display the two markers. Due to the different modes the horizontal positions can be different.

**Manual operation:** See "[Discrete](#)" on page 433

**CALCulate<Chn>:MARKer<Mk>:NAME <MarkerName>**

Defines a name for marker no. <Mk>. The marker doesn't have to be created before ([CALCulate<Chn>:MARKer<Mk>\[:STATe\] ON](#)), the name can be assigned in advance.

**Suffix:**

<Chn> Channel number used to identify the active trace

<Mk> Marker number.

**Parameters:**

<MarkerName> Marker name (string parameter)

\*RST: 'M1' for marker no. 1 etc.

**Example:**

Suppose that the active channel setup contains an active trace no. 1.

```
CALC:MARK:NAME '&$% 1'; :CALC:MARK ON
```

Create marker 1 named "&\$% 1" and display the marker .

```
CALC:MARK:REF ON
```

```
CALC:MARK:REF:NAME 'Reference'
```

Display the reference marker and rename it "Reference".

**Manual operation:** See "[Marker Name](#)" on page 432

**CALCulate<Chn>:MARKer<Mk>:REFerence[:STATe] <Boolean>**

Creates the reference marker and assigns it to trace no. <Chn>.

**Suffix:**

<Chn> Channel number used to identify the active trace

<Mk> This numeric suffix is ignored and may be set to any value.



**Parameters:**

<Boolean> ON | OFF - creates or removes the marker.  
 \*RST: OFF

**Example:**

Suppose that the active channel setup contains an active trace no. 1.  
 CALC:MARK:REF ON; :CALC:MARK ON  
 Create the reference marker and marker 1 and assign them to trace no. 1. The default position of both markers is the center of the sweep range.

**Manual operation:** See "On" on page 430

**CALCulate<Chn>:MARKer<Mk>:REFerence:FORMat <OutFormat>**

Sets/queries the output format for the (complex) value of the reference marker.

**Suffix:**

<Chn> Channel number used to identify the active trace  
 <Mk> This numeric suffix is ignored and may be set to any value.

**Parameters:**

<OutFormat> MLINear | MLOGarithmic | PHASe | POLar | GDELay | REAL |  
 IMAGinary | SWR | LINPhase | LOGPhase | IMPedance |  
 ADMittance | DEFault | COMPLex | MDB | MLPHase |  
 MDPHase | MIMPedance | PIMPedance | PADmittance |  
 MADmittance | MPIMPedance | MPADmittance | INDX  
 DEFault means the reference marker is formatted according  
 the related trace's default marker format (see  
[CALCulate<Chn>:MARKer:DEFault:FORMat](#)).  
 For the other marker formats, see [CALCulate<Chn>:MARKer:  
 DEFault:FORMat](#) and the description in "Marker Format"  
 on page 201.  
 \*RST: DEFault

**Manual operation:** See "Marker Format" on page 433

**CALCulate<Chn>:MARKer<Mk>:REFerence:MODE <Mode>**

Sets the reference marker to continuous or discrete mode. The marker doesn't have to be created before ([CALCulate<Chn>:MARKer<Mk>\[:STATe\] ON](#)), the mode can be assigned in advance.

**Suffix:**

<Chn> Channel number used to identify the active trace  
 <Mk> This numeric suffix is ignored and may be set to any value.

**Parameters:**

<Mode> CONTInuous | DISCcrete  
 CONTInuous - marker can be positioned on any point of the trace, and its response values are obtained by interpolation.  
 DISCcrete - marker can be set to discrete sweep points only.  
 \*RST: CONT

**Example:**

Suppose that the active channel setup contains an active trace no. 1.

```
CALC:MARK:REF:MODE DISC
```

```
CALC:MARK2:REF:MODE CONT
```

Create the reference marker in discrete mode and marker 2 in continuous mode.

```
CALC:MARK:REF ON; :CALC:MARK2 ON
```

Display the two markers. Due to the different modes the horizontal positions can be different.

**Manual operation:** See ["Discrete"](#) on page 433

**CALCulate<Chn>:MARKer<Mk>:REFerence:NAME <MarkerName>**

Defines a name for the reference marker. The marker doesn't have to be created before ([CALCulate<Chn>:MARKer<Mk>\[:STATe\] ON](#)), the name can be assigned in advance.

**Suffix:**

<Chn> Channel number used to identify the active trace  
 <Mk> This numeric suffix is ignored and may be set to any value.

**Parameters:**

<MarkerName> Marker name (string parameter)  
 \*RST: 'R'

**Example:** See [CALCulate<Chn>:MARKer<Mk>:NAME](#)

**Manual operation:** See ["Marker Name"](#) on page 432

**CALCulate<Chn>:MARKer<Mk>:REFerence:TYPE <Mode>**

Sets the marker mode of the related reference marker. The marker must be created before using [CALCulate<Chn>:MARKer<Mk>:REFerence\[:STATe\] ON](#).

**Suffix:**

<Chn> Channel number used to identify the active trace  
 <Mk> This numeric suffix is ignored and may be set to any value.

**Parameters:**

<Mode> NORMal | FIXed | ARBitrary  
 See [CALCulate<Chn>:MARKer<Mk>:TYPE](#).  
 \*RST: NORMal

**Example:** `CALC:MARK:REF ON; :CALC:MARK:REF:TYPE FIX`  
 Create the reference marker and display it in the center of the sweep range as a fixed marker.  
`CALC:MARK:REF:X 1GHz`  
 Shift the marker horizontally. The response value remains fixed.

**Manual operation:** See "[Marker Mode](#)" on page 433

---

**CALCulate<Chn>:MARKer<Mk>:REFerence:X** <StimulusValue>[, <Seg>[, <MeasPoint>]]

In NORMal or FIXed marker mode (see [CALCulate<Chn>:MARKer<Mk>:TYPE](#)) this command sets or gets the stimulus value of the reference marker. In ARbitrary mode this is only true if the X axis represents the stimulus. For all other trace formats (see [CALCulate<Chn>:FORMat](#)) it sets or gets the X position of the reference marker, which is decoupled from the marker stimulus in this case.

**Suffix:**

<Chn> Channel number used to identify the active trace  
 <Mk> This numeric suffix is ignored and may be set to any value.

**Parameters:**

<StimulusValue> If the marker mode of the related marker is ARbitrary and the trace format is complex (Polar, Smith, inverted Smith), this is the real part  $\text{Re}(z_M)$  of the marker value  $z_M$ . In any other case, it is the marker's stimulus value.  
 If the marker mode is ARbitrary and the trace format is complex, the value range is -1 to +1. Otherwise -9.9E+11 Hz to +9.9E+11 Hz for frequency sweeps, 0 s to 127500 s for time sweeps and 1 to 100001 for CW mode.

**Setting parameters:**

<Seg> For a segmented frequency sweep with overlapping segments, you can assign the reference marker to a particular segment. If specified, the <Seg> number must be valid and the <StimulusValue> must be inside the segment.  
 <Point> For a segmented frequency sweep with overlapping segments or with segments that have multiple sweep points at the same frequency, you can assign the reference marker to a particular segment <Seg> and sweep point <Point>. If specified, the <Seg> and <Point> numbers must be valid and the <StimulusValue> must be inside the segment.

**Example:** Suppose that the active channel setup contains an active trace no. 1 and that the sweep range for a frequency sweep starts at 1 GHz.

```
CALC:MARK:REF ON
```

Create the reference marker and display it in the center of the sweep range.

```
CALC:MARK:REF:X 1GHz
```

Set the reference marker to the beginning of the sweep range.

```
CALC:MARK:REF:Y?
```

Query the measurement value at the reference marker position.

**Manual operation:** See "[Mkr <i> Stimulus / Ref Mkr Stimulus](#)" on page 430

### **CALCulate<Chn>:MARKer<Mk>:REFerence:Y <RefResponseValue>**

Sets or gets the (response) value of the related reference marker.

The marker must be created before using [CALCulate<Chn>:MARKer<Mk>:REFerence\[:STATE\] ON](#).

Setting this value is only possible in ARbitrary mode (see [CALCulate<Chn>:MARKer<Mk>:REFerence:TYPE](#)). For NORMal and FIXed mode markers it is read-only.

**Suffix:**

<Chn> Channel number used to identify the active trace

<Mk> This numeric suffix is ignored and may be set to any value.

**Parameters:**

<RefResponseValue> See [CALCulate<Chn>:MARKer<Mk>:Y](#)

Default unit: NN

**Example:** See [CALCulate<Chn>:MARKer<Mk>:REFerence:X](#)

**Manual operation:** See "[Mkr <i> Arb. Response / Ref Mkr Arb. Response](#)" on page 430

### **CALCulate<Chn>:MARKer<Mk>:SEARch:TRACking <Boolean>**

This command is only available if a search mode is active ([CALCulate<Chn>:MARKer<Mk>:FUNction:EXECute ...](#))

It enables or disables tracking, which causes the search logic of the related marker(s) to be repeated after each sweep.

**Tip:** If the current search mode is a bandfilter or multiple peak search this command enables or disables the corresponding tracking.

**Suffix:**

<Chn> Channel number used to identify the active trace

<Mk> Number of an existing marker.  
If a bandfilter search or a multiple peak search is active, tracking recalculates the whole marker set for each sweep and hence this suffix is ignored.

**Parameters:**

<Boolean> ON | OFF - enables or disables the marker tracking mode.  
\*RST: OFF

**Example:**

Suppose the active channel setup contains an active trace no. 1.  
CALC:MARK ON; :CALC:MARK:FUNC:EXEC MAXimum  
Create marker no. 1 and assign it to trace no. 1. Activate a maximum search for marker no. 1.  
CALC:MARK:SEAR:TRAC ON  
Enable the tracking mode for the created marker.

**Manual operation:** See "[Tracking](#)" on page 440

**CALCulate<Chn>:MARKer<Mk>:SEARch:FORMat <SearchFormat>**

Selects the format in which the target value shall be specified (see [CALCulate<Chn>:MARKer<Mk>:TARGet](#) on page 655).

Each marker may have a different target format. The table below gives an overview on how a complex target value  $z = x + jy$  is converted.

| Target Format | Description                                                                                                                 | Formula                                     |
|---------------|-----------------------------------------------------------------------------------------------------------------------------|---------------------------------------------|
| MLINear       | Magnitude of $z$ , unconverted.                                                                                             | $ z  = \sqrt{x^2 + y^2}$                    |
| MLOGarithmic  | Magnitude of $z$ in dB                                                                                                      | $\text{Mag}(z) = 20 \log z  \text{ dB}$     |
| PHASe         | Phase of $z$                                                                                                                | $\varphi(z) = \arctan(y/x)$                 |
| UPHase        | Unwrapped phase of $z$ comprising the complete number of $360^\circ$ phase rotations                                        | $\Phi(z) = \varphi(z) + 2k \cdot 360^\circ$ |
| REAL          | Real part of $z$                                                                                                            | $\text{Re}(z) = x$                          |
| IMAGinary     | Imaginary part of $z$                                                                                                       | $\text{Im}(z) = y$                          |
| SWR           | (Voltage) Standing Wave Ratio                                                                                               | $\text{SWR} = (1 +  z ) / (1 -  z )$        |
| DEFault       | Identical to trace format.<br><b>Note:</b> the Smith and Polar traces use "Lin Mag" as the default format for target value. | -                                           |

**Suffix:**

<Chn> Channel number used to identify the active trace

<Mk> Marker number.

**Parameters:**

<SearchFormat> MLINear | MLOGarithmic | PHASe | UPHase | REAL |  
 IMAGinary | SWR | DEFault  
 Identifies the search format for the target value of the marker.  
 See table above.  
 \*RST: DEFault

**Example:**

Suppose channel 1's selected trace is POLar and marker 1 isn't yet created  
 :CALCULATE1:MARKER1 ON  
 Create/enable Marker 1  
 :CALCulate1:MARKer1:FUNction:SElect TARGet  
 Select TARGet search mode for marker 1  
 :CALCulate1:MARKer1:SEARch:FORMat?  
 Query the target format of marker 1. The result is DEF and for polar diagrams the default target format is "Phase".  
 :CALCulate1:MARKer1:FUNction:TARGet?  
 Query for the default target value; for "Phase" this is 0 (degrees)  
 :CALCulate1:MARKer1:SEARch:FORMat MLOGarithmic  
 Change the target search format to dB magnitude  
 :CALCulate1:MARKer1:FUNction:TARGet?  
 Query for the default target value; for dB magnitude this is 0 (dB)  
 :CALCulate1:MARKer1:FUNction:TARGet -3  
 Set the target value to -3 dB  
 :CALCulate1:MARKer1:FUNction:EXECute  
 Execute the target search for marker 1  
 :CALCulate1:MARKer1:FUNction:RESult?  
 Query for the results.

**Manual operation:** See "[Target Format](#)" on page 446

**CALCulate<Chn>:MARKer<Mk>[:STATe] <Boolean>**

Creates the marker numbered <Mk> and assigns it to trace no. <Chn>.

**Suffix:**

<Chn> Channel number used to identify the active trace  
 <Mk> Marker number. If unspecified the numeric suffix is set to 1.

**Parameters:**

<Boolean> ON | OFF – creates or removes the marker.  
 \*RST: OFF

**Example:**

Suppose that the active channel setup contains an active trace no. 1.  
 CALC:MARK ON; MARK2 ON  
 Create markers 1 and 2 and assign them to trace no. 1. The default position of both markers is the center of the sweep range.

**Manual operation:** See "[On](#)" on page 430

**CALCulate<Chn>:MARKer<Mk>:TARGet <TargetSearchVal>**

Defines the target value for the target search of marker no. <Mk>, which can be activated using `CALCulate<Chn>:MARKer<Mk>:FUNCTION:EXECute TARGet`.

**Suffix:**

<Chn> Channel number used to identify the active trace

<Mk> Marker number.

**Parameters:**

<TargetSearchVal> Target search value of marker no. <Mk>. The value range and reset value depend on the selected target format (see `CALCulate<Chn>:MARKer<Mk>:SEARCH:FORMat` on page 653).

**Example:**

```
CALC:MARK ON
```

Create marker no. 1 and display it in the center of the sweep range.

```
:CALC:MARK:TARG -10; FUNC:EXEC TARG
```

Define a target search value of -10 dB and start the target search.

```
CALC:MARK:X?
```

Query the stimulus value corresponding to the target search result.

**Manual operation:** See "[Target Value](#)" on page 446

**CALCulate<Chn>:MARKer<Mk>:THReshold <Value>**

Defines a marker-specific threshold value for (single) peak searches.

Use `CALCulate<Chn>:MARKer<Mk>:THReshold:STATe` to activate it.

**Suffix:**

<Chn> Channel number used to identify the active trace

<Mk> Marker number

**Parameters:**

<Value> Threshold value  
The unit is derived from the active trace format and cannot be modified. Changing the trace format resets the threshold to a format-specific default value.

**Manual operation:** See "[Threshold Settings](#)" on page 443

**CALCulate<Chn>:MARKer<Mk>:THReshold:STATe <Active>**

Activates or deactivates the marker-specific threshold for (single) peak searches.

Use `CALCulate<Chn>:MARKer<Mk>:THReshold` to set the threshold value.

**Suffix:**

<Chn> Channel number used to identify the active trace

<Mk> Marker number

**Parameters:**

<Active> Boolean

**Manual operation:** See "[Threshold Settings](#)" on page 443

**CALCulate<Chn>:MARKer<Mk>:TYPE <Mode>**

Sets the marker mode for the related marker. The marker must be created before using [CALCulate<Chn>:MARKer<Mk>\[:STATE\]](#) ON.

**Suffix:**

<Chn> Channel number used to identify the active trace

<Mk> Marker number.

**Parameters:**

<Mode> NORMal | FIXed | ARBitary

**NORMal:** If tracking is enabled ([CALCulate<Chn>:MARKer<Mk>:SEARCH:TRACking](#) ON), the marker's stimulus value [CALCulate<Chn>:MARKer<Mk>:X?](#) is updated automatically with every sweep, otherwise it is fixed. The marker position [CALCulate<Chn>:MARKer<Mk>:Y?](#) is adjusted to the corresponding response value, i.e. the marker is always positioned on the trace.

The marker's stimulus value can be set using [CALCulate<Chn>:MARKer<Mk>:X](#); the marker automatically follows the trace.

**FIXed:** freezes the marker at the position determined by the current stimulus and response value. The response value stored with the marker is not adjusted to subsequent sweeps. Tracking is disabled. Stimulus and response value are stored with the marker; they are not adjusted to subsequent sweeps and trace format changes.

The marker stimulus can be set using [CALCulate<Chn>:MARKer<Mk>:X](#), but the response value remains fixed.

**ARBitary:** freezes the marker at the position determined by the current stimulus and response value. Tracking is disabled. The marker stores the stimulus value and – in addition – its X and Y coordinates in the current marker format (see [CALCulate<Chn>:MARKer<Mk>:FORMat](#)).

The marker position can be set using [CALCulate<Chn>:MARKer<Mk>:X](#) and [CALCulate<Chn>:MARKer<Mk>:Y](#). If, in the current trace format, the X axis represents the stimulus, the marker's stimulus value is adjusted accordingly. Otherwise the marker's stimulus value remains unchanged. Switching between trace formats resets the marker position to the response value at the marker's stimulus value.



\*RST:        NORMal

**Example:**

```
CALC:MARK ON; :CALC:MARK:TYPE FIX
```

Create marker 1 and display it in the center of the sweep range as a fixed marker.

```
CALC:MARK:X 1GHz
```

Shift the marker horizontally. The response value remains fixed.

**Manual operation:** See "[Marker Mode](#)" on page 433

**CALCulate<Chn>:MARKer<Mk>:X** <StimulusValue>[, <Seg>[, <MeasPoint>]]

If the mode of the related marker is NORMal or FIXed (see [CALCulate<Chn>:MARKer<Mk>:TYPE](#)), this command sets or gets the marker's stimulus value.

In ARbitrary mode this is only true if the X axis represents the stimulus. For all other trace formats (see [CALCulate<Chn>:FORMat](#)) it sets or gets the X position of the marker, which is decoupled from the marker stimulus in this case.

**Suffix:**

<Chn>                    Channel number used to identify the active trace

<Mk>                    Marker number

**Parameters:**

<StimulusValue>        If the marker mode of the related marker is ARbitrary and the trace format is complex (Polar, Smith, inverted Smith), this is the real part  $\text{Re}(z_M)$  of the marker value  $z_M$ . In any other case, it is the marker's stimulus value.

If the marker mode is ARbitrary and the trace format is complex, the value range is -1 to +1. Otherwise -9.9E+11 Hz to +9.9E+11 Hz for frequency sweeps, 0 s to 127500 s for time sweeps and 1 to 100001 for CW mode.

**Setting parameters:**

<Seg>                    For a segmented frequency sweep with overlapping segments, you can assign the marker to a particular segment. If specified, the <Seg> number must be valid and the <Stimulus-Value> must be inside the segment.

<Point>                  For a segmented frequency sweep with overlapping segments or with segments that have multiple sweep points at the same frequency, you can assign the marker to a particular segment <Seg> and sweep point <Point>.

If specified, the <Seg> and <Point> numbers must be valid and the <StimulusValue> must be inside the segment.

**Example:** Suppose that the active channel setup contains an active trace no. 1 and the sweep range for a frequency sweep starts at 1 GHz.

```
CALC:MARK ON
```

Create marker no. 1 and display it in the center of the sweep range.

```
CALC:MARK:X 1GHz
```

Set the marker to the beginning of the sweep range.

**Manual operation:** See "[Mkr <i> Stimulus / Ref Mkr Stimulus](#)" on page 430

**CALCulate<Chn>:MARKer<Mk>:Y <ResponseValue>**

Sets or gets the (response) value of the related marker.

The marker must be created before using [CALCulate<Chn>:MARKer<Mk>\[:STATe\] ON](#).

Setting this value is only possible in ARbitrary mode (see [CALCulate<Chn>:MARKer<Mk>:TYPE](#)). For NORMal and FIXed mode markers it is read-only.

**Suffix:**

<Chn> Channel number used to identify the active trace

<Mk> Marker number.

**Parameters:**

<ResponseValue> **Setting (ARbitrary mode only):** sets the vertical position of the marker in Y units of the current trace format.

**Query:** returns the marker position formatted according to the current marker format (see [CALCulate<Chn>:MARKer<Mk>:FORMat](#)), i.e. as displayed in the marker info field (1 return value per row in the response column). Indetermined result values are returned as a sequence of dashes (-----). This may occur in ARbitrary mode, if the transformation between trace format and marker format requires a concrete stimulus value.

Default unit: NN

**Example:** Suppose that the active channel setup contains an active trace no. 1.

```
CALC:MARK ON
```

Create marker no. 1 and display it in the center of the sweep range.

```
CALC:MARK:Y?
```

Query the measurement value at the marker position.

```
CALC:MARK:STAT:AREA LEFT, TOP
```

For a subsequent check at the GUI or a hardcopy, move the info field to the top left position.

**Manual operation:** See "[Mkr <i> Arb. Response / Ref Mkr Arb. Response](#)" on page 430

**CALCulate:MATH...**

The `CALCulate:MATH...` commands permit processing of measured data in numerical expression format. The operators are +, -, \*, / and use of constants and data arrays are permitted.

|                                                                             |     |
|-----------------------------------------------------------------------------|-----|
| <code>CALCulate&lt;Chn&gt;:MATH[:EXPRession]:SDEFine</code> .....           | 659 |
| <code>CALCulate&lt;Chn&gt;:MATH:FORMatted[:EXPRession]:SDEFine</code> ..... | 659 |
| <code>CALCulate&lt;Chn&gt;:MATH:FUNctIon</code> .....                       | 660 |
| <code>CALCulate&lt;Chn&gt;:MATH:FORMatted:FUNctIon</code> .....             | 660 |
| <code>CALCulate&lt;Chn&gt;:MATH:MEMorize</code> .....                       | 661 |
| <code>CALCulate&lt;Chn&gt;:MATH:STATe</code> .....                          | 662 |
| <code>CALCulate&lt;Chn&gt;:MATH:FORMatted:STATe</code> .....                | 662 |
| <code>CALCulate&lt;Chn&gt;:MATH:WUNit[:STATe]</code> .....                  | 662 |

---

**CALCulate<Chn>:MATH[:EXPRession]:SDEFine** <Expression>

**CALCulate<Chn>:MATH:FORMatted[:EXPRession]:SDEFine** <Expression>

Defines a mathematical trace for the active trace, using a string expression.

- The expression in the first command refers to raw, unformatted trace data (complex data). In order to apply it, `CALCulate<Chn>:MATH:FUNctIon` must be set to `NORMal` and `CALCulate<Chn>:MATH:STATe` must be set to `ON`.
- The expression in the second command refers to formatted trace data. In order to apply it, `CALCulate<Chn>:MATH:FORMatted:FUNctIon` must be set to `NORMal` and `CALCulate<Chn>:MATH:FORMatted:STATe` must be set to `ON`.

Trace math for unformatted and formatted trace data can be used at the same time.

**Suffix:**

<Chn> Channel number used to identify the active trace

**Parameters:**

<Expression> Operands, operators and functions; see table below.

**Example:**

```
*RST; :CALC:MATH:MEM
```

Copy the current state of the default trace 'Trc1' to a memory trace named 'Mem2[Trc1]'. The memory trace is not displayed.

```
CALC:MATH:SDEF 'Trc1 / Mem2[Trc1]'
```

Define a mathematical trace, dividing the raw complex data trace by the stored memory trace. The mathematical trace is not displayed.

```
CALC:MATH:STAT ON
```

Display the mathematical trace instead of the active data trace.

**Manual operation:** See "[Expression builder](#)" on page 342

Expressions defined via `CALCulate<Ch>:MATH[:EXPRession]:SDEFine` or `CALCulate<Chn>:MATH:FORMatted[:EXPRession]:SDEFine` may contain the following elements:

| Type              | Complete List                                                                                                                                                 | Description                                                                                                                      |
|-------------------|---------------------------------------------------------------------------------------------------------------------------------------------------------------|----------------------------------------------------------------------------------------------------------------------------------|
| Operands          | <Trace name>  <br>activeTrc  <br>Mem[activeTrc]                                                                                                               | All traces and memory traces of the active channel setup  <br>Active trace  <br>Active memory trace assigned to the active trace |
| Constants         | e, pi  <br>1, -1.2, 8e9  <br>1 + 2j, 2 + 1e-9j                                                                                                                | Constants  <br>Real values in decimal or exponential format  <br>Complex numbers                                                 |
| Operators         | - + , - , * , / , ^                                                                                                                                           | Basic arithmetic operations; ^ for exponentiation                                                                                |
| Functions         | linMag (), dBMag (), Arg (),<br>Re (), Im (), log (), ln (), tan (),<br>atan (), sin (), asin (), cos (),<br>acos (),<br>Min ( ... , ... ), Max ( ... , ... ) | Mathematical functions with one or two arguments                                                                                 |
| Special Functions | StimVal                                                                                                                                                       | Current stimulus value (see description of operators for User Defined Math)                                                      |
| Brackets          | ( )                                                                                                                                                           | Priority of operations in complex expressions                                                                                    |

**CALCulate<Chn>:MATH:FUNCTION <Mode>****CALCulate<Chn>:MATH:FORMatted:FUNCTION <Mode>**

Defines a simple mathematical trace based on the active trace and its active memory trace. The first command applies to raw, unformatted trace data (complex data), the second to formatted trace data. Both methods can be combined.

To apply the trace math, the corresponding mathematical mode must be switched on using `CALCulate<Chn>:MATH:STATe ON` and/or `CALCulate<Chn>:MATH:FORMatted:STATe ON`.

**Note:** Use `CALCulate<Chn>:MATH[:EXPRession]:SDEFine` and/or `CALCulate<Chn>:MATH:FORMatted[:EXPRession]:SDEFine` to define general math traces.

**Suffix:**

<Chn> Channel number used to identify the active trace

**Parameters:**

<Mode> NORMAL | ADD | SUBTract | MULTipty | DIVide

NORMAL – Math. trace = active data trace

ADD – Math. trace = data + memory

SUBTract – Math. trace = data - memory

MULTipty – Math. trace = data \* memory

DIVide – Math. trace = data / memory

When set to NORMAL, the corresponding mathematical mode is turned OFF, otherwise it is turned ON.

\*RST: NORMAL

**Example:** \*RST; :CALC:MATH:MEM  
Copy the current state of the default trace 'Trc1' to a memory trace named 'Mem2[Trc1]'. The memory trace is not displayed.

CALC:MATH:FUNC DIV

Define a mathematical trace, dividing the raw complex data trace trace by the stored memory trace. The mathematical trace is displayed instead of the active data trace.

CALC:MATH:STAT?

The response is 1 (mathematical mode for unformatted trace data switched on, mathematical trace displayed).

**Manual operation:** See "Data / <Mem>, Data - <Mem>" on page 340

### CALCulate<Chn>:MATH:MEMorize

Copies the current state of the active data trace to a memory trace. If a mathematical trace is active, the data trace associated with the mathematical trace is copied. The memory trace is named Mem<n>[<Data\_Trace>] where <n> counts all data and memory traces in the active channel setup in chronological order, and <Data\_Trace> is the name of the associated (copied) data trace.

The exact function of the command depends on the number of memory traces associated to the active data trace:

- If no memory trace is associated to the active trace, a new memory trace is generated.
- If several memory traces are associated to the active trace, the current measurement data overwrites the last generated or changed memory trace.

**Note:** To copy a trace to the memory without overwriting an existing memory trace or define a memory trace name, use [TRACe:COPI](#)

<MemTraceName>, <DataTraceName>. To copy an active mathematical trace use [TRACe:COPI:MATH](#) <MemTraceName>, <DataTraceName>

#### Suffix:

<Chn> Channel number used to identify the active trace

#### Example:

\*RST; :CALC:MATH:MEM

Copy the current state of the default trace 'Trc1' to a memory trace named 'Mem2[Trc1]'. The memory trace is not displayed.

DISP:WIND:TRAC2:FEED 'Mem2[Trc1]'

Display the created memory trace in the active diagram area (diagram area no. 1).

**Usage:** Event

**Manual operation:** See "Data to <Destination>" on page 336

---

**CALCulate<Chn>:MATH:STATe** <Boolean>

**CALCulate<Chn>:MATH:FORMatted:STATe** <Boolean>

Activates or deactivates trace math for unformatted and/or formatted trace data, i.e. the trace formulae defined via `CALCulate<Chn>:MATH[:EXPRession]:SDEFine` and/or `CALCulate<Chn>:MATH:FORMatted[:EXPRession]:SDEFine`, respectively.

When trace math is active either for unformatted or formatted data, the resulting mathematical trace is calculated and displayed instead of the active data trace.

**Suffix:**

<Chn> Channel number used to identify the active trace

**Parameters:**

<Boolean> ON – apply trace math on the  
 OFF – display the active data trace  
 \*RST: OFF

**Example:**

\*RST; :CALC:MATH:MEM

Copy the current state of the default trace 'Trc1' to a memory trace named 'Mem2[Trc1]'. The memory trace is not displayed.

CALC:MATH:SDEF 'Trc1 / Mem2[Trc1]'

Define a mathematical trace, dividing the complex data trace by the stored complex memory trace. The mathematical trace is not displayed.

CALC:MATH:STAT ON

Display the mathematical trace instead of the active data trace.

**Manual operation:** See ["Trace Math"](#) on page 340

---

**CALCulate<Chn>:MATH:WUNit[:STATe]** <Boolean>

Controls the conversion and formatting of the mathematic expression defined via `CALCulate<Chn>:MATH[:EXPRession]:SDEFine`.

**Suffix:**

<Chn> Channel number used to identify the active trace

**Parameters:**

<Boolean> ON –"Result is Wave Quantity" enabled: the analyzer assumes that the result of the mathematical expression represents a voltage.  
 OFF –"Result is Wave Quantity" disabled: the analyzer assumes that the result of the mathematical expression is dimensionless.  
 \*RST: OFF

**Example:**           \*RST; CALC:PAR:SDEF 'Trc1', 'a1'  
 Reset the instrument and select a wave quantity  $a_1$  for the trace Trc1.  
 DISP:WIND:TRAC:FEED 'Trc1'  
 Display the generated trace in the active window.  
 CALC:MATH:SDEF '1.1\*Data'; STAT ON  
 Define a mathematical trace and display it instead of the active data trace.  
 CALC:MATH:WUN ON

**Manual operation:** See ["Result is Wave Quantity"](#) on page 343

### CALCulate:PARAmeter...

The CALCulate:PARAmeter... commands assign names and measurement parameters to traces. The commands are device-specific.

|                                              |     |
|----------------------------------------------|-----|
| CALCulate:PARAmeter:DELeTe:ALL.....          | 663 |
| CALCulate:PARAmeter:DELeTe:MEMory.....       | 663 |
| CALCulate<Ch>:PARAmeter:CATalog?.....        | 664 |
| CALCulate<Ch>:PARAmeter:CATalog:SENDED?..... | 664 |
| CALCulate<Ch>:PARAmeter:DEFine:SGRoup.....   | 664 |
| CALCulate<Ch>:PARAmeter:DELeTe.....          | 666 |
| CALCulate<Ch>:PARAmeter:DELeTe:CALL.....     | 667 |
| CALCulate<Ch>:PARAmeter:DELeTe:CMEMory.....  | 667 |
| CALCulate<Ch>:PARAmeter:DELeTe:SGRoup.....   | 667 |
| CALCulate<Ch>:PARAmeter:MEASure.....         | 667 |
| CALCulate<Ch>:PARAmeter:MEASure:SENDED.....  | 668 |
| CALCulate<Ch>:PARAmeter:SDEFine.....         | 668 |
| CALCulate<Ch>:PARAmeter:SDEFine:SENDED.....  | 670 |
| CALCulate<Ch>:PARAmeter:SELeT.....           | 671 |

---

### CALCulate:PARAmeter:DELeTe:ALL

Deletes all traces in all channels of the active channel setup, including the default trace Trc1 in channel 1. The manual control screen shows "No Trace".

**Example:**           See [CALCulate<Ch>:PARAmeter:DELeTe](#)

**Usage:**           Event

**Manual operation:** See ["Delete Trace"](#) on page 332

---

### CALCulate:PARAmeter:DELeTe:MEMory

Deletes all memory traces in all channels.

**Usage:**           Event

**Manual operation:** See ["Delete All Mem"](#) on page 339

**CALCulate<Ch>:PARAmeter:CATalog?**

Returns the trace names and measurement parameters of all traces assigned to a particular channel.

The result is a string containing a comma-separated list of trace names and measurement parameters, e.g. 'CH4TR1, S11, CH4TR2, S12'. The measurement parameters are returned according to the naming convention of [CALCulate<Ch>:PARAmeter:SDEFine](#). The order of traces in the list reflects their creation time: The oldest trace is the first, the newest trace is the last trace in the list.

**Suffix:**

<Ch> Channel number. If unspecified the numeric suffix is set to 1.

**Example:**

```
CALC4:PAR:SDEF 'Ch4Tr1', 'S11'
```

Create channel 4 and a trace named Ch4Tr1 to measure the input reflection coefficient S<sub>11</sub>.

```
CALC4:PAR:CAT?
```

Query the traces assigned to channel 4. If Ch4Tr1 is the only trace assigned to channel 4, the response is 'CH4TR1, S11'.

**Usage:**

Query only

**CALCulate<Ch>:PARAmeter:CATalog:SENDED?**

Returns the trace names and measurement parameters of all traces assigned to a particular channel.

Similar to [CALCulate<Ch>:PARAmeter:CATalog?](#), but in presence of balanced ports this command distinguishes between

- single-ended S-parameters for **logical** ports (SSS<Li><Lj>)
- "raw" single-ended S-parameters referring to **physical** ports (S<Pi><Pj>)

**Suffix:**

<Ch> Channel number. If unspecified the numeric suffix is set to 1.

**Usage:**

Query only

**CALCulate<Ch>:PARAmeter:DEFine:SGRoup <LogicalPort1>[, <LogicalPort2>]...**

Creates the traces for all S-parameters associated with a group of logical ports (S-parameter group). The traces can be queried using [CALCulate<Ch>:DATA:SGRoup?](#).

Traces must be selected to become active traces; see [CALCulate<Ch>:PARAmeter:SElect](#).

**Note:** Each channel can contain a single S-parameter group only. Defining a new S-parameter group deletes the previous one. Use [CALCulate<Ch>:PARAmeter:DElete:SGRoup](#) on page 667 to delete the current S-group explicitly.



**Suffix:**

&lt;Ch&gt;

Channel number. <Ch> may be used to reference a previously defined channel. If <Ch> does not exist, it is generated with default channel settings.

**Parameters:**

&lt;LogicalPort1&gt;

Logical (balanced or unbalanced) port numbers. The port numbers must be in ascending order, their number is limited by the test ports of the analyzer. With n logical port numbers, the command generates  $n^2$  traces. The traces correspond to the following S-parameters:

$$S_{\langle \text{log\_port1} \rangle \langle \text{log\_port1} \rangle}, S_{\langle \text{log\_port1} \rangle \langle \text{log\_port2} \rangle} \dots S_{\langle \text{log\_port1} \rangle \langle \text{log\_port} \langle n \rangle \rangle}$$

...

$$S_{\langle \text{log\_port} \langle n \rangle \rangle \langle \text{log\_port1} \rangle}, S_{\langle \text{log\_port} \langle n \rangle \rangle \langle \text{log\_port2} \rangle} \dots S_{\langle \text{log\_port} \langle n \rangle \rangle \langle \text{log\_port} \langle n \rangle \rangle},$$

e.g.  $S_{11}, S_{12}, S_{21}, S_{22}$  for <log\_port1> = 1, <log\_port2> = 2. If only one logical port <log\_port1> is specified, a single trace with the reflection coefficient  $S_{\langle \text{log\_port1} \rangle \langle \text{log\_port1} \rangle}$  is created.

**Trace names**

The generated traces are assigned the following trace names:

<Ch\_name>\_SG\_S<log\_port1><log\_port1>,  
 <Ch\_name>\_SG\_S<log\_port1><log\_port2> ...  
 <Ch\_name>\_SG\_S<log\_port1><log\_port<n>> ...<Ch\_name>\_S  
 G\_S<log\_port<n>><log\_port1>,  
 <Ch\_name>\_SG\_S<log\_port<n>><log\_port2>...  
 <Ch\_name>\_SG\_S<log\_port<n>><log\_port<n>>,  
 e.g. Ch1\_SG\_S11, Ch1\_SG\_S12, Ch1\_SG\_S21, Ch1\_SG\_S22  
 for <Ch\_name> = Ch1, <log\_port1> = 1, <log\_port2> = 2. The  
 trace names are displayed in the "Channel Manager" and in the  
 "Trace Manager" dialogs where they can be changed manually.  
 The <Ch\_name> is defined via  
 CONFigure:CHANnel<Ch>:NAME '<Ch\_name>'.  
 Trace names are important for referencing the generated traces;  
 see program example below.

<Ch\_name>\_SG\_S<log\_port1><log\_port2> ...<Ch\_name>\_S  
 G\_S<log\_port<n>><log\_port1>,  
 <Ch\_name>\_SG\_S<log\_port<n>><log\_port2>...  
 <Ch\_name>\_SG\_S<log\_port<n>><log\_port<n>>,  
 e.g. Ch1\_SG\_S11, Ch1\_SG\_S12, Ch1\_SG\_S21, Ch1\_SG\_S22  
 for <Ch\_name> = Ch1, <log\_port1> = 1, <log\_port2> = 2. The  
 trace names are displayed in the "Channel Manager" and in the  
 "Trace Manager" dialogs where they can be changed manually.  
 The <Ch\_name> is defined via  
 CONFigure:CHANnel<Ch>:NAME '<Ch\_name>'.  
 Trace names are important for referencing the generated traces;  
 see program example below.

<Ch\_name>\_SG\_S<log\_port<n>><log\_port2>...  
 <Ch\_name>\_SG\_S<log\_port<n>><log\_port<n>>,  
 e.g. Ch1\_SG\_S11, Ch1\_SG\_S12, Ch1\_SG\_S21, Ch1\_SG\_S22  
 for <Ch\_name> = Ch1, <log\_port1> = 1, <log\_port2> = 2. The  
 trace names are displayed in the "Channel Manager" and in the  
 "Trace Manager" dialogs where they can be changed manually.  
 The <Ch\_name> is defined via  
 CONFigure:CHANnel<Ch>:NAME '<Ch\_name>'.  
 Trace names are important for referencing the generated traces;  
 see program example below.

<Ch\_name>\_SG\_S<log\_port<n>><log\_port<n>>,  
 e.g. Ch1\_SG\_S11, Ch1\_SG\_S12, Ch1\_SG\_S21, Ch1\_SG\_S22  
 for <Ch\_name> = Ch1, <log\_port1> = 1, <log\_port2> = 2. The  
 trace names are displayed in the "Channel Manager" and in the  
 "Trace Manager" dialogs where they can be changed manually.  
 The <Ch\_name> is defined via  
 CONFigure:CHANnel<Ch>:NAME '<Ch\_name>'.  
 Trace names are important for referencing the generated traces;  
 see program example below.

e.g. Ch1\_SG\_S11, Ch1\_SG\_S12, Ch1\_SG\_S21, Ch1\_SG\_S22  
 for <Ch\_name> = Ch1, <log\_port1> = 1, <log\_port2> = 2. The  
 trace names are displayed in the "Channel Manager" and in the  
 "Trace Manager" dialogs where they can be changed manually.  
 The <Ch\_name> is defined via  
 CONFigure:CHANnel<Ch>:NAME '<Ch\_name>'.  
 Trace names are important for referencing the generated traces;  
 see program example below.

The trace names are displayed in the "Channel Manager" and in the  
 "Trace Manager" dialogs where they can be changed manually.  
 The <Ch\_name> is defined via  
 CONFigure:CHANnel<Ch>:NAME '<Ch\_name>'.  
 Trace names are important for referencing the generated traces;  
 see program example below.

The <Ch\_name> is defined via

CONFigure:CHANnel<Ch>:NAME '<Ch\_name>'.  
 Trace names are important for referencing the generated traces;  
 see program example below.

Trace names are important for referencing the generated traces;  
 see program example below.

&lt;LogicalPort2&gt;

**Example:**

```
CALC2:PAR:DEF:SGR 1,2
```

Create channel 2 and four traces to measure the two-port S-parameters  $S_{11}$ ,  $S_{12}$ ,  $S_{21}$ ,  $S_{22}$ . The traces are not displayed.

```
DISP:WIND:TRAC2:FEED 'Ch2_SG_S11'
DISP:WIND:TRAC3:FEED 'Ch2_SG_S12'
DISP:WIND:TRAC4:FEED 'Ch2_SG_S21'
DISP:WIND:TRAC5:FEED 'Ch2_SG_S22'
```

Display the four traces in the diagram no. 1.

```
INIT2:CONT OFF; :INIT2:IMMEDIATE; *OPC
```

Perform a complete sweep in channel no. 2 to ensure the traces are completely "filled" with data.

```
CALC2:DATA:SGR? SDAT
```

Retrieve all four traces as unformatted data (real and imaginary part at each sweep point). The analyzer first returns the complete  $S_{11}$  trace, followed by the  $S_{12}$ ,  $S_{21}$ , and  $S_{22}$  traces.

```
CALC2:PAR:DEL:SGR
```

Delete the previously created port group.

**Manual operation:** See ["All S-Params"](#) on page 377

---

#### CALCulate<Ch>:PARAmeter:DELeTe <TraceName>

Deletes a trace with a specified trace name and channel.

##### Suffix:

<Ch> Channel number.

##### Setting parameters:

<TraceName> Trace name, e.g. 'Trc4'. See "Rules for trace names" in [Chapter 10.6.1.2, "Trace Manager Dialog"](#), on page 333.

##### Example:

```
CALCulate4:PARAmeter:SDEFine 'Ch4Tr1', 'S11'
```

Create channel 4 and a trace named Ch4Tr1 to measure the input reflection coefficient  $S_{11}$ .

```
CALCulate4:PAR:CAT?
```

Query the traces assigned to channel 4. Ch4Tr1 is the only trace assigned to channel 4, so the response is

```
'CH4TR1,S11'
```

```
CALCulate4:PARAmeter:SDEFine 'CH4TR2', 'S21';
SDEFine 'CH4TR3', 'S12'; SDEFine 'CH4TR4',
'S22'
```

Create three more traces for the remaining 2-port S-parameters.

```
CALCulate4:PARAmeter:DELeTe 'CH4TR1'
```

Delete the first created trace.

```
CALCulate4:PARAmeter:DELeTe:CALL
```

Delete the remaining three traces in channel 4.

```
CALCulate:PARAmeter:DELeTe:ALL
```

Delete all traces, including the default trace Trc1 in channel 1.

**Usage:** Setting only

**Manual operation:** See ["Delete Trace"](#) on page 332

---

**CALCulate<Ch>:PARAmeter:DELeTe:CALL**

Deletes all traces in channel no. <Ch>.

**Suffix:**

<Ch> Channel number

**Example:** See [CALCulate<Ch>:PARAmeter:DELeTe](#)

**Usage:** Event

**Manual operation:** See ["Delete Trace"](#) on page 332

---

**CALCulate<Ch>:PARAmeter:DELeTe:CMEMory**

Deletes all memory traces in channel <Ch>.

**Suffix:**

<Ch> Channel number

**Usage:** Event

---

**CALCulate<Ch>:PARAmeter:DELeTe:SGRoup**

Deletes a group of logical ports (S-parameter group), previously defined via [CALCulate<Ch>:PARAmeter:DEFine:SGRoup](#).

**Suffix:**

<Ch> Channel number. <Ch> may be used to reference a previously defined channel. If <Ch> does not exist, it is generated with default channel settings.

**Example:** See [CALCulate<Ch>:PARAmeter:DEFine:SGRoup](#)

**Usage:** Event

---

**CALCulate<Ch>:PARAmeter:MEASure <TraceName>, <Result>**

Assigns a measurement result to an **existing** trace. The query returns the result assigned to the specified trace (no second parameter; see example).

**Note:** To create a new trace and at the same time assign the attributes, use [CALCulate<Ch>:PARAmeter:SDEFine](#). To display the trace, create a diagram ([DISPlay\[:WINDow<Wnd>\]\[:STATe\] ON](#)) and assign the trace to this diagram ([DISPlay\[:WINDow<Wnd>\]:TRACe<WndTr>:FEED](#)); see example below.

Traces must be selected to become active traces; see [CALCulate<Ch>:PARAmeter:SElect](#). [CALCulate<Ch>:PARAmeter:CATalog?](#) returns a list of all defined traces. You can open the "Trace Manager" dialog to obtain an overview of all channels and traces, including the traces that are not displayed.

**Suffix:**

<Ch> Channel number of an existing channel containing the referenced trace.

**Parameters:**

|             |                                                                                                                                                                                                                                                                                                                    |
|-------------|--------------------------------------------------------------------------------------------------------------------------------------------------------------------------------------------------------------------------------------------------------------------------------------------------------------------|
| <TraceName> | Trace name, string variable, e.g. 'Trc4'. See "Rules for trace names" in "Table Area" on page 333. Trace names must be unique across all channels and diagrams.                                                                                                                                                    |
| <Result>    | Measurement parameter (string variable); see Table 11-7.<br>A query of a wave quantity 'xy' returns 'xD<n><Detector>', where <n> numbers the source (drive) port, and <Detector> denotes the detector setting. A query of a ratio 'x/y' returns 'xD<n>/yD<m><Detector>', where <n> and <m> number the source ports |

**Example:**

```
CALC4:PAR:SDEF 'Ch4Tr1', 'S11'
```

Create channel 4 and a trace named Ch4Tr1 to measure the input reflection coefficient S<sub>11</sub>.

```
CALC4:PAR:MEAS 'Ch4Tr1', 'a1'
```

Change the measurement parameter of the trace and measure the wave quantity a<sub>1</sub>.

```
CALC4:PAR:MEAS? 'Ch4Tr1'
```

Query the measured quantity. The response is 'A1D1SAM'.

**Manual operation:** See "S-Parameter (selector)" on page 376

**CALCulate<Ch>:PARAmeter:MEASure:SENDED** <TraceName>, <Result>

Assigns a measurement result to an **existing** trace. The query returns the result assigned to the specified trace (no second parameter; see example).

Similar to [CALCulate<Ch>:PARAmeter:MEASure](#), but in presence of balanced ports this command distinguishes between

- single-ended S-parameters for **logical** ports (SSS<Li><Lj>)
- "raw" single-ended S-parameters referring to **physical** ports (S<Pi><Pj>)

**Suffix:**

<Ch> Channel number

**Setting parameters:**

<TraceName> Trace name

<Result> Measured quantity

**Manual operation:** See "S-Parameter (selector)" on page 376

**CALCulate<Ch>:PARAmeter:SDEFine** <TraceName>, <Result>

Creates a trace and assigns a channel number, a name and a measurement parameter to it. The trace becomes the active trace in the channel but is not displayed.

**Note:** To display the trace defined via `CALCulate<Ch>:PARAmeter:SDEFine`, create a diagram (`DISPlay[:WINDow<Wnd>] [:STATe] ON`) and assign the trace to this diagram (`DISPlay[:WINDow<Wnd>]:TRACe<WndTr>:FEED`); see example below. `CALCulate<Ch>:PARAmeter:MEASure` changes the measurement result of an existing trace.

To select an existing trace as the active trace, use `CALCulate<Ch>:PARAmeter:SElect`. You can open the trace manager to obtain an overview of all channels and traces, including the traces that are not displayed.

**Tip:** This command has no query form. Use `CALCulate<Ch>:PARAmeter:MEASure <TraceName>` to query the measurement result of the trace. `CALCulate<Ch>:PARAmeter:CATalog?` returns a list of all defined traces.

**Suffix:**

`<Ch>` Channel number. `<Ch>` may be used to reference a previously defined channel. If `<Ch>` does not exist, it is generated with default channel settings.

**Setting parameters:**

`<TraceName>` Trace name, string variable, e.g. 'Trc4'. See "Rules for trace names" in "Table Area" on page 333. Trace names must be unique across all channels and diagrams. If a trace with the selected trace name already exists, the analyzer behaves as follows: If the existing trace is assigned to the same channel as the new trace, it is deleted. The new trace is not automatically assigned to a diagram area; see note above. If the existing trace is assigned to a different channel, no new trace can be created. The analyzer returns an error message.

`<Result>` Measurement result (string variable), see table below.

**Example:**

```
CALC4:PAR:SDEF 'Ch4Tr1', 'S11'
Create channel 4 and a trace named Ch4Tr1 to measure the
input reflection coefficient S11.
DISP:WIND2:STAT ON
Create diagram area no. 2.
DISP:WIND2:TRAC:FEED 'CH4TR1'
Display the generated trace in diagram area no. 2.
```

**Usage:** Setting only

**Manual operation:** See "Add Trace" on page 331

**Table 11-7: String identifiers for measurement results**

|                                                                                                                                                                                                                                                                                                                                                                                   |                                                                                                                                                            |
|-----------------------------------------------------------------------------------------------------------------------------------------------------------------------------------------------------------------------------------------------------------------------------------------------------------------------------------------------------------------------------------|------------------------------------------------------------------------------------------------------------------------------------------------------------|
| <b>Note:</b>                                                                                                                                                                                                                                                                                                                                                                      |                                                                                                                                                            |
| All port numbers in a result identifier refer to <b>logical (=DUT) ports</b> ; to avoid ambiguities they must be represented by the same number of digits (e.g. S21 or S0201). The valid port numbers are determined by the channel's logical port configuration. For details about the measurement results see <a href="#">Chapter 9.3, "Measurement Results"</a> , on page 217. |                                                                                                                                                            |
| 'S11'   'S12'   ...   'S0101'   ...                                                                                                                                                                                                                                                                                                                                               | Single-ended S-parameters S<i><j> for logical (DUT) ports <i> and <j>. To avoid ambiguities, <i> and <j> must be specified with the same number of digits. |

|                                                                                                                                     |                                                                                                                                                                                                                                                                                                                                                                                                                                                                                                     |
|-------------------------------------------------------------------------------------------------------------------------------------|-----------------------------------------------------------------------------------------------------------------------------------------------------------------------------------------------------------------------------------------------------------------------------------------------------------------------------------------------------------------------------------------------------------------------------------------------------------------------------------------------------|
| 'SCD11'   ...                                                                                                                       | S-parameters involving balanced ports must be specified in the form $S_{\langle m_i \rangle \langle m_j \rangle \langle i \rangle \langle j \rangle}$ , where $\langle m_i \rangle$ and $\langle m_j \rangle$ denote the port modes of the related logical ports $\langle i \rangle$ and $\langle j \rangle$ . In general, for the port modes $\langle m_i \rangle \langle m_j \rangle$ all pairs of D (differential, balanced), C (common, balanced) and S (single-ended, unbalanced) are allowed. |
| 'Y11'   ...   'YSS11'   ...   'YCC11'   ...   'YDD11'   'Z11'   ...   'ZSS11'   ...   'ZCC11'   ...   'ZDD11'   ...                 | Short-circuit Y-parameters and open-circuit Z-parameters with port modes and port numbers like for normal mode S-parameters.<br><br>Selecting a parameter $Y_{\dots \langle n \rangle \langle m \rangle}$ or $Z_{\dots \langle n \rangle \langle m \rangle}$ sets the range of logical port numbers to be considered for the Y and Z-parameter measurement to $\langle n \rangle : \langle m \rangle$ .                                                                                             |
| 'Y-S11'   ...   'Y-SSS11'   ...   'Y-SCC11'   ...   'Y-SDD11'   'Z-S11'   ...   'Z-SSS11'   ...   'Z-SCC11'   ...   'Z-SDD11'   ... | S-parameters converted to matched-circuit admittances and impedances with port modes and port numbers like for normal mode S-parameters. For transmission parameters, this refers to series resistances.                                                                                                                                                                                                                                                                                            |
| 'Y-S12SER'   'Y-S12PAR'   ...   'Z-S12SER'   'Z-S12PAR'   ...                                                                       | Converted transmission admittances and impedances, calculated as <a href="#">series</a> <a href="#">Chapter 9, "VNA Concepts and Features"</a> , on page 186 or <a href="#">parallel</a> admittances/impedances.                                                                                                                                                                                                                                                                                    |
| 'SHUNT-S12'   'SHUNT-S21'                                                                                                           | Converted impedances measured using shunt-thru method.                                                                                                                                                                                                                                                                                                                                                                                                                                              |
| 'A1'   ...   'A01'   ...   'B1'   ...   'B01'   ...                                                                                 | Wave quantities $A_{\langle meas \rangle D1}$ (for a wave) and $B_{\langle meas \rangle D1}$ .                                                                                                                                                                                                                                                                                                                                                                                                      |
| 'A1D2'   ...   'A01D02'   ...   'B1D2'   ...   'B01D02'   ...                                                                       | Wave quantities $A_{\langle meas \rangle D \langle drive \rangle}$ (for a wave) and $B_{\langle meas \rangle D \langle drive \rangle}$ (for b wave) for logical ports $\langle meas \rangle$ and $\langle drive \rangle$ .                                                                                                                                                                                                                                                                          |
| 'B2/A1'   ...   'B02/A01'   ...                                                                                                     | Ratio of wave quantities with port numbers like for normal mode S-parameters.                                                                                                                                                                                                                                                                                                                                                                                                                       |
| 'B2D1/A1D1'   ...   'B02D01/A01D01'   ...                                                                                           | Ratios of wave quantities with drive ports                                                                                                                                                                                                                                                                                                                                                                                                                                                          |
| 'IMB1-23'   'IMB23-1'   'IMB1-24'   ...                                                                                             | Differential Imbalance parameters between a balanced and two single-ended logical ports                                                                                                                                                                                                                                                                                                                                                                                                             |
| 'KFAC21'   'KFAC12'   ...                                                                                                           | Stability factor K (for unbalanced ports only)                                                                                                                                                                                                                                                                                                                                                                                                                                                      |
| 'MUF121'   'MUF112'   ...                                                                                                           | Stability factor 1 (for unbalanced ports only)                                                                                                                                                                                                                                                                                                                                                                                                                                                      |
| 'MUF221'   'MUF212'   ...                                                                                                           | Stability factor 2 (for unbalanced ports only)                                                                                                                                                                                                                                                                                                                                                                                                                                                      |

\*) Selecting a parameter  $Y_{\dots \langle n \rangle \langle m \rangle}$  or  $Z_{\dots \langle n \rangle \langle m \rangle}$  sets the range of port numbers to be considered for the Y and Z-parameter measurement to  $\langle n \rangle : \langle m \rangle$ .

---

#### **CALCulate<Ch>:PARAmeter:SDEFine:SENDED** <TraceName>, <Result>

Creates a trace and assigns a channel number, a name and a measurement parameter to it. The trace becomes the active trace in the channel but is not displayed.

Similar to [CALCulate<Ch>:PARAmeter:SDEFine](#), but in presence of balanced ports this command distinguishes between

- single-ended S-parameters for **logical** ports ( $SSS_{\langle Li \rangle \langle Lj \rangle}$ )
- "raw" single-ended S-parameters referring to **physical** ports ( $S_{\langle Pi \rangle \langle Pj \rangle}$ )

#### **Suffix:**

<Ch> Channel number

#### **Setting parameters:**

<TraceName> Trace name

|                          |                                                            |
|--------------------------|------------------------------------------------------------|
| <Result>                 | Measured quantity                                          |
| <b>Usage:</b>            | Setting only                                               |
| <b>Manual operation:</b> | See " <a href="#">S-Parameter (selector)</a> " on page 376 |

---

### **CALCulate<Ch>:PARAmeter:SElect <TraceName>**

Selects an existing trace as the active trace of the channel. All trace commands without explicit reference to the trace name act on the active trace (e.g. [CALCulate<Chn>:FORMat](#)). `CALCulate<Ch>:PARAmeter:SElect` is also necessary if the active trace of a channel has been deleted.

**Suffix:**

<Ch> Channel number.

**Parameters:**

<TraceName> Trace name, e.g. 'Trc4'. See "Rules for trace names" in "[Table Area](#)" on page 333.

**Example:**

```
CALC4:PAR:SDEF 'Ch4Tr1', 'S11'
```

Create channel 4 and a trace named Ch4Tr1 to measure the input reflection coefficient  $S_{11}$ . The trace is the active trace in channel 4.

```
CALC4:PAR:SDEF 'Ch4Tr2', 'S22'
```

Create another trace named Ch4Tr2 to measure the output reflection coefficient  $S_{22}$ . Again this new trace becomes the active trace in channel 4.

```
CALC4:PAR:SEL 'Ch4Tr1'
```

Select the first trace Ch4Tr1 as the active trace.

```
CALC4:FORM MLIN
```

Calculate the magnitude of  $S_{11}$  and display it in a linearly scaled Cartesian diagram.

**CALCulate:PHOLd...**

The `CALCulate:PHOLd...` commands control the max hold (peak hold) function.

---

### **CALCulate<Chn>:PHOLd <HoldFunc>**

Enables, disables, or restarts the max hold and the min hold functions.

**Suffix:**

<Chn> Channel number used to identify the active trace

**Parameters:**

<HoldFunc> MIN | MAX | OFF

MIN - Enable the min hold function.

MAX - enable the max hold function.

OFF - disable the max hold or min hold function.

\*RST: OFF

**Example:**            \*RST; :CALC:PHOL MAX  
 Reset the instrument and enable the max hold function.  
 CALC:PHOL OFF; PHOL MAX  
 Restart max hold.

**Manual operation:** See "Hold" on page 365

### CALCulate:RIPple...

The CALCulate:RIPple... commands define the ripple limits and control the ripple limit check.

|                                                        |     |
|--------------------------------------------------------|-----|
| CALCulate:RIPple:DISPlay:RESult:ALL[:STATe].....       | 672 |
| CALCulate:RIPple:FAIL:ALL?.....                        | 672 |
| CALCulate<Chn>:RIPple:CLEar.....                       | 673 |
| CALCulate<Chn>:RIPple:CONTRol:DOMain.....              | 673 |
| CALCulate<Chn>:RIPple:DATA.....                        | 674 |
| CALCulate<Chn>:RIPple:DELeTe:ALL.....                  | 674 |
| CALCulate<Chn>:RIPple:DISPlay[:STATe].....             | 675 |
| CALCulate<Chn>:RIPple:FAIL?.....                       | 675 |
| CALCulate<Chn>:RIPple:RDOMain:FORMat.....              | 676 |
| CALCulate<Chn>:RIPple:SEGMENT:COUNT?.....              | 676 |
| CALCulate<Chn>:RIPple:SEGMENT<Seg>[:STATe].....        | 677 |
| CALCulate<Chn>:RIPple:SEGMENT<Seg>:LIMit.....          | 677 |
| CALCulate<Chn>:RIPple:SEGMENT<Seg>:RESult?.....        | 678 |
| CALCulate<Chn>:RIPple:SEGMENT<Seg>:STIMulus:START..... | 679 |
| CALCulate<Chn>:RIPple:SEGMENT<Seg>:STIMulus:STOP.....  | 679 |
| CALCulate<Chn>:RIPple:SOUND[:STATe].....               | 679 |
| CALCulate<Chn>:RIPple:STATe.....                       | 680 |
| CALCulate<Chn>:RIPple:STATe:AREA.....                  | 680 |

---

### CALCulate:RIPple:DISPlay:RESult:ALL[:STATe] <Enable>

Configures the display of ripple check info fields for the active channel setup.

#### Parameters:

<Enable>            ON - Info fields are displayed for all traces, for which a limit check is enabled.  
                       OFF - Only the info field for the active trace is displayed (if the ripple check is enabled for this trace).  
 \*RST:              OFF

**Manual operation:** See "Show Results All Traces" on page 422

---

### CALCulate:RIPple:FAIL:ALL? [<ChannelSetup>]

Returns a 0 or 1 to indicate whether or not the global ripple limit check has failed for at least one channel in the referenced channel setup.

#### Query parameters:

<ChannelSetup>    Name of a VNA channel setup. Can be omitted if the active VNA channel setup shall be referenced.



**Usage:** Query only  
**Manual operation:** See ["Ripple Check"](#) on page 421

#### **CALCulate<Chn>:RIPple:CLEar**

Resets the limit check results for the ripple test.

**Suffix:**  
 <Chn> Channel number used to identify the active trace

**Usage:** Event

**Manual operation:** See ["Clear Test"](#) on page 422

#### **CALCulate<Chn>:RIPple:CONTrol:DOMain <SweepType>**

Deletes the existing ripple limit ranges and (re-)defines the physical units of the stimulus values of the ripple limit lines. The unit of the ripple limit is defined via [CALCulate<Chn>:RIPple:RDOMain:FORMat](#).

**Suffix:**  
 <Chn> Channel number used to identify the active trace

**Setting parameters:**

<SweepType> FLIN | FLOG | FSEG | FSINgle | TLIN | TLOG  
 Keywords for the units of the stimulus values; frequency and time units.  
 The selected unit must be compatible with the sweep type (see [\[SENSe<Ch>: \]SWEep:TYPE](#) on page 905): Hz for FLIN, FLOG, FSEG and FSINgle, s for TLIN and TLOG. Otherwise the ripple limit lines cannot be displayed and no ripple limit check is possible.

\*RST: FLIN

**Example:**  
 SWE:TYPE LOG  
 Select a logarithmic frequency sweep.  
 CALC:RIPP:CONT:DOM FLIN  
 Delete all existing ripple limit ranges and select linear frequency units for the domain of the active trace.  
 CALC:RIPP:DATA 1, 1000000000, 2000000000, 3  
 Define and enable a ripple limit range in the stimulus range between 1 GHz and 2 GHz, assigning a ripple limit of 3 dB.

**Usage:** Setting only

**Manual operation:** See ["Add / Insert / Delete / Delete All / Align All"](#) on page 423

**CALCulate<Chn>:RIPple:DATA <RippleLimRange>...**

Adds and enables/disables an arbitrary number of ripple limit ranges, assigning the stimulus values and the ripple limits. See [Chapter 9.4.1.2, "Rules for Ripple Test Definition"](#), on page 234.

**Note:** This command does not overwrite existing ripple limit ranges. The defined ranges are appended to the range list as new ranges. Use the `CALCulate<Chn>:RIPple:SEGment<Seg>...` commands to change existing ripple limits.

**Suffix:**

<Chn> Channel number used to identify the active trace

**Parameters:**

<RippleLimRange> Parameter list in the format <Type>, <StartStimulus>, <StopStimulus>, <RippleLimit>[, {<Type>, <StartStimulus>, <StopStimulus>, <RippleLimit>}], where:

- <Type> – Boolean identifier for the ripple limit range type. 1 for ripple limit range on (with limit check). 0 for ripple limit range off: The range is defined, but no limit check result displayed. The result is still available via `CALCulate<Chn>:RIPple:SEGment<Seg>:RESult?`.
- <StartStimulus>/<StopStimulus>– stimulus values (unitless) confining the ripple limit range
- <RippleLimit> – ripple limit (unitless) in the stimulus range between <StartStimulus> and <StopStimulus>

The unit of a stimulus value is adjusted to the sweep type of the active channel (`[SENSe<Ch>:]SWEep:TYPE`), the unit of a ripple limit is adjusted to the format of the active trace (`CALCulate<Chn>:FORMat`).

Range: Virtually no restriction for ripple limit ranges.

\*RST: n/a (no ripple limit line defined after a reset)

**Example:**

```
*RST; CALC:RIPP:DATA 1, 1500000000, 2000000000,
3, 1, 2000000000, 3000000000, 5
```

Define and enable a ripple limit range in the stimulus range between 1.5 GHz and 2 GHz, assigning a ripple limit of +3 dB.

Define and enable a second ripple limit range in the stimulus range between 2 GHz and 3 GHz, assigning a ripple limit of +5 dB.

```
CALC:RIPP:DISP ON
```

Show the ripple limits in the active diagram.

**Manual operation:** See ["Add / Insert / Delete / Delete All / Align All"](#) on page 423

**CALCulate<Chn>:RIPple:DELeTe:ALL**

Deletes all ripple limit ranges.

**Suffix:**

<Chn> Channel number used to identify the active trace

**Example:** `*RST; CALC:RIPP:DATA 1,1500000000, 2000000000, 3, 1, 2000000000, 3000000000, 5`  
 Define and enable a ripple limit range in the stimulus range between 1.5 GHz and 2 GHz, assigning a ripple limit of +3 dB. Define and enable a second ripple limit range in the stimulus range between 2 GHz and 3 GHz, assigning a ripple limit of +5 dB.  
`CALC:RIPP:DEL:ALL`  
 Delete both created ripple limit ranges.

**Usage:** Event

**Manual operation:** See "[Add / Insert / Delete / Delete All / Align All](#)" on page 423

**CALCulate<Chn>:RIPple:DISPlay[:STATe]** <Boolean>

Displays or hides all ripple limit lines (including all ranges) associated to the active trace.

**Suffix:**  
 <Chn> Channel number used to identify the active trace

**Parameters:**  
 <Boolean> ON | OFF - ripple limit line on or off.  
 \*RST: OFF

**Example:** `*RST; CALC:RIPP:DATA 1,1500000000, 2000000000, 3`  
 Define and enable a ripple limit range in the stimulus range between 1.5 GHz and 2 GHz, assigning a ripple limit of +3 dB.  
`CALC:RIPP:DISP ON`  
 Show the ripple limit range in the active diagram.

**Manual operation:** See "[Show Ripple Limits](#)" on page 420

**CALCulate<Chn>:RIPple:FAIL?**

Returns a 0 or 1 to indicate whether or not the global ripple limit check has failed.

**Tip:** Use `CALCulate<Chn>:RIPple:SEGment<Seg>:RESult?` to query the result for a single ripple limit range.

**Suffix:**  
 <Chn> Channel number used to identify the active trace

- Example:** `*RST; CALC:RIPP:DATA 1, 1500000000, 2000000000, 3`  
 Define and enable a ripple limit range in the stimulus range between 1.5 GHz and 2 GHz, assigning a ripple limit of +3 dB.  
`CALC:RIPP:STAT ON; FAIL?`  
 Switch the limit check on and query the result.  
`CALC:RIPP:STAT:AREA LEFT, TOP`  
 For a subsequent check at the GUI or a hardcopy, move the info field to the top left position.
- Usage:** Query only
- Manual operation:** See "[Ripple Check](#)" on page 421

### **CALCulate<Chn>:RIPple:RDOMain:FORMat <UnitRef>**

Deletes the existing ripple limit ranges and (re-)defines the physical unit of the ripple limit. The units of the stimulus values are defined via `CALCulate<Chn>:RIPple:CONTrol:DOMain`.

**Suffix:**

<Chn> Channel number used to identify the active trace

**Setting parameters:**

<UnitRef> COMPlEx | MAGNitude | PHASe | REAL | IMAGinary | SWR | GDELay | L | C  
 Keyword for the physical unit of the response values; dimensionless numerss, relative power, phase, time, inductance, capacitance units.

\*RST: n/a  
 Default unit: 1 (U, for COMPlEx, REAL, IMAGinary, and SWR); dB (for MAGNitude), deg (for PHASe), s (for GDELay), H (Henry, for L), F (Farad, for C).

- Example:** `*RST; CALC:RIPP:DATA 1, 1500000000, 2000000000, 3`  
 Define and enable a ripple limit range in the stimulus range between 1.5 GHz and 2 GHz, assigning a ripple limit of +3 dB.  
`CALC:RIPP:RDOM:FORM COMP`  
 Delete the ripple limit range, select complex units for the ripple limit.

**Usage:** Setting only

### **CALCulate<Chn>:RIPple:SEGment:COUNT?**

Queries the number of ripple limit ranges. The response is an integer number.

**Suffix:**

<Chn> Channel number used to identify the active trace

**Example:** \*RST; CALC:RIPP:DATA 1, 1500000000, 2000000000, 3, 1, 2000000000, 3000000000, 5  
 Define and enable a ripple limit range in the stimulus range between 1.5 GHz and 2 GHz, assigning a ripple limit of +3 dB. Define and enable a second ripple limit range in the stimulus range between 2 GHz and 3 GHz, assigning a ripple limit of +5 dB.  
 CALC:RIPP:SEGM:COUNT?  
 Query the number of ranges. The response is 2.

**Usage:** Query only

**Manual operation:** See "[Range List](#)" on page 423

#### CALCulate<Chn>:RIPple:SEGment<Seg>[:STATe] <Boolean>

Enables or disables the limit check in the ripple limit range no. <Seg>.

**Suffix:**

<Chn> Channel number used to identify the active trace

<Seg> Number of the ripple limit range.

**Parameters:**

<Boolean> ON | OFF - Limit check on or off. A result is available even if the limit check is disabled; see example for [CALCulate<Chn>:RIPple:SEGment<Seg>:RESult?](#).

\*RST: n/a (no ripple limit line defined after a reset)

**Example:** See [CALCulate<Chn>:RIPple:SEGment<Seg>:STIMulus:START](#)

**Manual operation:** See "[Range List](#)" on page 423

#### CALCulate<Chn>:RIPple:SEGment<Seg>:LIMit <Limit>

Defines the ripple limit for ripple limit range no. <Seg>. A range must be created first to enable this command (e.g. [CALCulate<Chn>:RIPple:DATA](#)). See [Chapter 9.4.1.2, "Rules for Ripple Test Definition"](#), on page 234.

**Tip:** To define several ripple limit ranges with a single command, use [CALCulate<Chn>:RIPple:DATA](#).

**Suffix:**

<Chn> Channel number used to identify the active trace

<Seg> Number of the ripple limit range.

**Parameters:**

<Limit> Ripple limit in the range. The unit is adjusted to the format of the active trace (`CALCulate<Chn>:FORMat`).

Range: Virtually no restriction for ripple limit ranges.

\*RST: n/a (no ripple limit line defined after a reset)

Default unit: See above.

**Example:**

See `CALCulate<Chn>:RIPPlE:SEGMENT<Seg>:STIMulus:START`

**Manual operation:** See "Range List" on page 423

**CALCulate<Chn>:RIPPlE:SEGMENT<Seg>:RESult?**

Returns the result of the ripple limit check in the previously defined limit range no. <Seg>. The response consists of two parameters:

- <Boolean> – 0 for "passed", 1 for "failed".
- <Limit> – measured ripple in the limit range. A result is returned even if the limit check in the range no. <Seg> is disabled; see example below.

A reset deletes all ripple limit ranges. Use `CALCulate<Ch>:RIPPlE:FAIL?` to query the result for global ripple limit check.

**Note:** In remote control, the ripple limit check result is calculated once at the end of each sweep. If the ripple limits are changed, a new sweep is required to obtain updated ripple limit check results. In single sweep mode (`INITiate<Ch>:CONTinuous OFF`), the new sweep must be started explicitly. This behavior is different from manual control where a changed ripple limit line can directly affect the pass/fail result of the displayed trace.

**Suffix:**

<Chn> Channel number used to identify the active trace

<Seg> Number of the ripple limit range.

**Example:**

```
*RST; CALC:RIPP:DATA 1, 1500000000, 2000000000,
3
```

Define and enable a ripple limit range in the stimulus range between 1.5 GHz and 2 GHz, assigning a ripple limit of +3 dB.

```
CALC:RIPP:STAT ON; SEGM:RES?
```

Enable the limit check and query the result for the created range. Possible response: 0,0.3529814004.

```
CALC:RIPP:DATA 0, 2500000000, 3000000000, 3
```

Define a second ripple limit range with disabled limit check (no limit check results are displayed in the diagram area).

```
CALC:RIPP:SEGM2:RES?
```

Query the result for the second range. Possible response: 0,1.149071925.

**Usage:**

Query only

**Manual operation:** See "Ripple Check" on page 421

**CALCulate<Chn>:RIPple:SEGment<Seg>:STIMulus:STARt <FreqPowTime>**  
**CALCulate<Chn>:RIPple:SEGment<Seg>:STIMulus:STOP <StimValue>**

These commands change the start or stop stimulus values (i.e. the smallest or largest stimulus values) of a ripple limit range. A range must be created first to enable these commands (e.g `CALCulate<Chn>:RIPple:DATA`). See [Chapter 9.4.1.2, "Rules for Ripple Test Definition"](#), on page 234.

**Tip:** To define several ripple limit ranges with a single command, use `CALCulate<Chn>:RIPple:DATA`.

**Suffix:**

<Chn> Channel number used to identify the active trace  
 <Seg> Number of the ripple limit range.

**Parameters:**

<StimValue> Stimulus values (unitless) confining the ripple limit range. The unit is adjusted to the sweep type of the active channel (`[SENSe<Ch>:]SWEep:TYPE`).

Range: Virtually no restriction for ripple limit ranges.  
 \*RST: n/a (no ripple limit line defined after a reset)  
 Default unit: NN

**Example:**

```
*RST; CALC:RIPP:DATA 1,1500000000, 2000000000,3
Define and enable a ripple limit range in the stimulus range
between 1.5 GHz and 2 GHz, assigning a ripple limit of +3 dB.
CALC:RIPP:SEGM:STIM:STAR 1GHZ; STOP 2.5 GHZ; :
CALC:RIPP:SEGM:LIM 5
Change the range to a stimulus range between 1 GHz and 2.5
GHz and a limit of 5 dB.
CALC:RIPP:SEGM:STAT OFF
Disable the limit check in the modified stimulus range.
```

**Manual operation:** See ["Range List"](#) on page 423

**CALCulate<Chn>:RIPple:SOUNd[:STATe] <Boolean>**

Switches the acoustic signal (fail beep) on or off. The fail beep is generated each time the analyzer detects an exceeded ripple limit.

**Suffix:**

<Chn> Channel number used to identify the active trace

**Parameters:**

<Boolean> ON | OFF - fail beep on or off.  
 \*RST: OFF

**Example:**

```
CALC:RIPP:STAT ON; SOUN ON
Switch the limit check on and activate the fail beep.
```

**Manual operation:** See ["Ripple Fail Beep"](#) on page 421

**CALCulate<Chn>:RIPple:STATe** <Boolean>

Switches the ripple limit check for the active trace on or off.

**Tip:** Use `CALCulate<Chn>:RIPple:SEGment<Seg>[:STATe]` to switch the limit check for a single ripple limit range on or off.

**Suffix:**

<Chn> Channel number used to identify the active trace

**Parameters:**

<Boolean> ON | OFF – ripple limit check on or off.  
\*RST: OFF

**Example:** See `CALCulate<Chn>:RIPple:FAIL?`

**Manual operation:** See "Ripple Check" on page 421

**CALCulate<Chn>:RIPple:STATe:AREA** <HorizontalPos>, <VerticalPos>

Moves the ripple test info field for the active trace <Chn> to one of nine predefined positions in the active diagram.

**Suffix:**

<Chn> Channel number used to identify the active trace

**Parameters:**

<HorizontalPos> LEFT | MID | RIGHT  
Horizontal position  
<VerticalPos> TOP | MID | BOTTom  
Vertical position

**Example:** See `CALCulate<Chn>:RIPple:FAIL?`

**Manual operation:** See "Ripple Check" on page 421

**CALCulate:SMOothing...**

The `CALCulate:SMOothing...` commands provide the settings for trace smoothing.

`CALCulate<Chn>:SMOothing[:STATe]`..... 680  
`CALCulate<Chn>:SMOothing:APERture`..... 681

**CALCulate<Chn>:SMOothing[:STATe]** <Boolean>

Enables or disables smoothing for trace no. <Chn>.

**Suffix:**

<Chn> Channel number used to identify the active trace

**Parameters:**

<Boolean> ON | OFF - smoothing on or off.  
\*RST: OFF



**Example:** See `CALCulate<Chn>:SMOothing:APERture`

**Manual operation:** See "Smoothing" on page 364

### **CALCulate<Chn>:SMOothing:APERture <SmoothAperture>**

Defines how many measurement points are averaged to smooth the trace.

**Suffix:**

<Chn> Channel number used to identify the active trace

**Parameters:**

<SmoothAperture> Smoothing aperture. A smoothing aperture of n % means that the smoothing interval for each sweep point i with stimulus value  $x_i$  is equal to  $[x_i - \text{span} * n / 200, x_i + \text{span} * n / 200]$ , and that the result of i is replaced by the arithmetic mean value of all measurement points in this interval.

Range: 0.05% to 100%.

\*RST: 1

Default unit: %

**Example:**

\*RST; :CALC:SMO ON

Activate smoothing for the default trace.

CALC:SMO:APER 0.5

Reduce the smoothing aperture to 0.5 %.

**Manual operation:** See "Aperture" on page 364

### **CALCulate:STATistics...**

The `CALCulate:STATistics...` commands evaluate and display statistical and phase information of the trace.

|                                                                      |     |
|----------------------------------------------------------------------|-----|
| <code>CALCulate&lt;Chn&gt;:STATistics[:STATe]</code> .....           | 681 |
| <code>CALCulate&lt;Chn&gt;:STATistics[:STATe]:AREA</code> .....      | 682 |
| <code>CALCulate&lt;Chn&gt;:STATistics:DOMain:USER</code> .....       | 683 |
| <code>CALCulate&lt;Chn&gt;:STATistics:DOMain:USER:SHOW</code> .....  | 683 |
| <code>CALCulate&lt;Chn&gt;:STATistics:DOMain:USER:START</code> ..... | 683 |
| <code>CALCulate&lt;Chn&gt;:STATistics:DOMain:USER:STOP</code> .....  | 683 |
| <code>CALCulate&lt;Chn&gt;:STATistics:EPDelay[:STATe]</code> .....   | 684 |
| <code>CALCulate&lt;Chn&gt;:STATistics:MMPTpeak[:STATe]</code> .....  | 684 |
| <code>CALCulate&lt;Chn&gt;:STATistics:MSTDdev[:STATe]</code> .....   | 684 |
| <code>CALCulate&lt;Chn&gt;:STATistics:FORMat</code> .....            | 684 |
| <code>CALCulate&lt;Chn&gt;:STATistics:RESult?</code> .....           | 684 |
| <code>CALCulate&lt;Chn&gt;:STATistics:RMS[:STATe]</code> .....       | 685 |
| <code>CALCulate&lt;Chn&gt;:STATistics:SFLatness[:STATe]</code> ..... | 685 |

### **CALCulate<Chn>:STATistics[:STATe] <Boolean>**

Displays or hides all statistical results in the diagram area of trace no. <Chn>.

**Tip:** You can display or hide the "Min/Max/Peak-Peak", "Mean/Std Dev/RMS", "Phase/EI Length" and "Flatness/Gain/Slope" results separately; see example below.

**Suffix:**

<Chn> Channel number used to identify the active trace

**Parameters:**

<Boolean> ON | OFF - Statistical info field on or off.

\*RST: OFF

**Example:**

```
*RST; :CALC:STAT:MMPT ON
```

Reset the instrument, hiding all statistical results. Display the "Min/Max/Peak-Peak" results.

```
CALC:STAT:MSTD ON
```

Display the "Mean/Std Dev" results in addition.

```
CALC:STAT:RMS ON
```

Display the "RMS" results in addition.

```
CALC:STAT:EPD ON
```

Display the "Phase/EI Length" results in addition.

```
CALC:STAT:SFL ON
```

Display the "Flatness/Gain/Slope" results in addition.

```
CALC:STAT:STAT:AREA LEFT, TOP
```

For a subsequent check at the GUI or a hardcopy, move the info field to the top left position.

...

```
CALC:STAT OFF
```

Hide all results.

**Manual operation:** See ["Min/Max/Peak-Peak, Mean/Std Dev/RMS"](#) on page 360

**CALCulate<Chn>:STATistics[:STATe]:AREA** <HorizontalPos>, <VerticalPos>

Moves the statistics info field for the active trace <Chn> to one of nine predefined positions in the active diagram.

**Suffix:**

<Chn> Channel number used to identify the active trace

**Parameters:**

<HorizontalPos> LEFT | MID | RIGHT

Horizontal position

<VerticalPos> TOP | MID | BOTTOm

Vertical position

**Example:**

See `CALCulate<Chn>:STATistics[:STATe]`

**Manual operation:** See ["Min/Max/Peak-Peak, Mean/Std Dev/RMS"](#) on page 360

**CALCulate<Chn>:STATistics:DOMain:USER <EvalRange>**

Selects one out of 10 evaluation ranges to be configured with the `CALCulate<Chn>:STATistics:DOMain:USER:SHOW`, `CALCulate<Chn>:STATistics:DOMain:USER:START`, and `CALCulate<Chn>:STATistics:DOMain:USER:STOP` commands.

**Suffix:**

<Chn> Channel number used to identify the active trace

**Parameters:**

<EvalRange> Number of the evaluation range.

Range: 1 to 10. In addition, 0 denotes the (non-configurable) "Full Span" evaluation range.

\*RST: 0

**Example:**

\*RST; :CALC:STAT:DOM:USER?

Query the default evaluation range. The response is zero, i.e. the evaluation range is equal to the complete sweep range

`CALC:STAT:DOM:USER 1`

`CALC:STAT:DOM:USER:START 1GHZ; STOP 2GHZ; SHOW ON`

Select evaluation range no. 1 and define the evaluation range between 1 GHz and 2 GHz. Display the range limit lines.

**Manual operation:** See ["Evaluation Range"](#) on page 363

**CALCulate<Chn>:STATistics:DOMain:USER:SHOW <Boolean>**

Displays or hides range limit lines for the evaluation range selected via `CALCulate<Chn>:STATistics:DOMain:USER`.

**Suffix:**

<Chn> Channel number used to identify the active trace

**Parameters:**

<Boolean> ON | OFF - range limit lines on or off.

\*RST: OFF

**Example:**

See `CALCulate<Chn>:STATistics:DOMain:USER`

**Manual operation:** See ["Range Limit Lines On"](#) on page 363

**CALCulate<Chn>:STATistics:DOMain:USER:START <Start>****CALCulate<Chn>:STATistics:DOMain:USER:STOP <Stop>**

These commands define the start and stop values of the evaluation range selected via `CALCulate<Chn>:STATistics:DOMain:USER`.

**Suffix:**

<Chn> Channel number used to identify the active trace

**Parameters:**

<Stop> Start or stop value of the evaluation range.  
Default unit: NN

**Example:**

See `CALCulate<Chn>:STATistics:DOMain:USER`

**Manual operation:** See "Evaluation Range" on page 363

**CALCulate<Chn>:STATistics:EPDelay[:STATe]** <Boolean>

**CALCulate<Chn>:STATistics:MMPTpeak[:STATe]** <Boolean>

**CALCulate<Chn>:STATistics:MSTDdev[:STATe]** <Boolean>

These commands display or hide the "Phase/EI Length" results, the "Min/Max/Peak-Peak" results, and the "Mean/Std Dev" results in the diagram area of trace no. <Chn>.

**Suffix:**

<Chn> Channel number used to identify the active trace

**Parameters:**

<Boolean> ON | OFF - statistical info field on or off.  
\*RST: OFF

**Example:**

See `CALCulate<Chn>:STATistics[:STATe]`

**Manual operation:** See "Min/Max/Peak-Peak, Mean/Std Dev/RMS" on page 360

**CALCulate<Chn>:STATistics:FORMat** <Format>

For complex-valued traces (Smith, Polar) this determines how the MEAN, STDDev, MAX, MIN, RMS and PTPeak statistics are calculated, see `CALCulate<Chn>:STATistics:RESult?`.

**Suffix:**

<Chn> Channel number used to identify the active trace

**Parameters:**

<Format> ZVAB | IMPedance | ADMittance

**ZVAB**

The results are based on unformatted wave quantities (voltages)

**IMPedance**

The results are based on resistance values

**ADMittance**

The results are based on conductance vaules

**Manual operation:** See "Format" on page 361

**CALCulate<Chn>:STATistics:RESult?** <Result>

Returns a single statistical parameter of the trace no. <Chn> or all parameters. It is not necessary to display the info field (`CALCulate<Chn>:STATistics[:STATe]` ON) before using this command.

**Suffix:**

<Chn> Channel number used to identify the active trace

**Query parameters:**

<Result>

MEAN | STDDev | MAX | MIN | RMS | PTPeak | PEAK2p | ELENgth | PDElay | GAIN | SLOPe | FLATness | ALL

MEAN - return arithmetic mean value of all response values of the trace in the entire sweep range (or in the evaluation range defined in manual control).

STDDev - return standard deviation of all response values.

MAX - return the maximum of all response values.

MIN - return the minimum of all response values.

RMS - return the root mean square of all response values.

PTPeak - return the peak-to-peak value (MAX - MIN).

ELENgth - return the electrical length.

PDElay - return the phase delay.

GAIN - return the gain, i.e. the larger of two marker values.

SLOPe - return the slope (difference) between two marker values.

FLATness - return the flatness of the trace between two marker positions.

ALL - return all statistical values, observing the order used above.

The data is returned as a comma-separated list of real numbers.

The unit is the default unit of the measured parameter (see

[CALCulate<Ch>:PARAmeter:SDEFine](#)) but may also depend

on the trace format (see [CALCulate<Chn>:FORMat](#)). For complex

traces the statistical results MEAN, STDDev, MAX, MIN,

RMS and PTPeak are calculated in the selected format (see

[CALCulate<Chn>:STATistics:FORMat](#)).

**Example:**

```
*RST; :CALC:STAT:RES? MAX
```

Calculate and return the maximum of the default trace showing an S-parameter on a dB Mag scale.

```
:CALC:FORM POL; STAT:RES? MAX
```

Display the trace in a polar diagram and re-calculate the maximum. The result corresponds to the previous result but is converted to a unitless linear value.

**Usage:**

Query only

**Manual operation:** See "[Min/Max/Peak-Peak, Mean/Std Dev/RMS](#)" on page 360

---

**CALCulate<Chn>:STATistics:RMS[:STATe] <Boolean>**

**CALCulate<Chn>:STATistics:SFLatness[:STATe] <Boolean>**

These commands display or hide the "RMS" and the "Flatness/Gain/Slope" results in the diagram area of trace no. <Chn>.

**Suffix:**

<Chn> Channel number used to identify the active trace

**Parameters:**

<Boolean> ON | OFF - statistical info field on or off.  
\*RST: OFF

**Example:** See `CALCulate<Chn>:STATistics[:STATe]`

**Manual operation:** See "Flatness/Gain/Slope" on page 362

**CALCulate:TDVSwr...**

---

**CALCulate:TDVSwr[:STATe]** <Boolean>

Enables/disables time domain site VSWR measurements.

**Parameters:**

<Boolean> ON | OFF – TD-VSWR on or off.  
\*RST: OFF

**CALCulate:TRANSform...**

The `CALCulate:TRANSform...` commands convert measured data from one representation to another and control the transformation into the time domain (see [Chapter 9.7.1, "Time Domain Analysis"](#), on page 282).

|                                                                                 |     |
|---------------------------------------------------------------------------------|-----|
| <code>CALCulate&lt;Chn&gt;:TRANSform:COMPLex</code> .....                       | 686 |
| <code>CALCulate&lt;Chn&gt;:TRANSform:IMPedance:RNORmal</code> .....             | 687 |
| <code>CALCulate&lt;Chn&gt;:TRANSform:TIME[:TYPE]</code> .....                   | 687 |
| <code>CALCulate&lt;Chn&gt;:TRANSform:TIME:CENTer</code> .....                   | 688 |
| <code>CALCulate&lt;Chn&gt;:TRANSform:TIME:DCHebyshev</code> .....               | 689 |
| <code>CALCulate&lt;Chn&gt;:TRANSform:TIME:LPASs</code> .....                    | 689 |
| <code>CALCulate&lt;Chn&gt;:TRANSform:TIME:LPASs:DCSPam</code> .....             | 689 |
| <code>CALCulate&lt;Chn&gt;:TRANSform:TIME:LPASs:DCSPam:CONTInuous</code> .....  | 690 |
| <code>CALCulate&lt;Chn&gt;:TRANSform:TIME:LPASs:DCSPam:EXTRapolate</code> ..... | 691 |
| <code>CALCulate&lt;Chn&gt;:TRANSform:TIME:LPFRequency</code> .....              | 691 |
| <code>CALCulate&lt;Chn&gt;:TRANSform:TIME:RESolution:EFACtor</code> .....       | 691 |
| <code>CALCulate&lt;Chn&gt;:TRANSform:TIME:SPAN</code> .....                     | 691 |
| <code>CALCulate&lt;Chn&gt;:TRANSform:TIME:START</code> .....                    | 692 |
| <code>CALCulate&lt;Chn&gt;:TRANSform:TIME:STATe</code> .....                    | 692 |
| <code>CALCulate&lt;Chn&gt;:TRANSform:TIME:STIMulus</code> .....                 | 693 |
| <code>CALCulate&lt;Chn&gt;:TRANSform:TIME:STOP</code> .....                     | 693 |
| <code>CALCulate&lt;Chn&gt;:TRANSform:TIME:WINDow</code> .....                   | 694 |
| <code>CALCulate&lt;Chn&gt;:TRANSform:TIME:XAXis</code> .....                    | 694 |

---

**CALCulate<Chn>:TRANSform:COMPLex** <Result>

Converts S-parameters into converted (matched-circuit) Y-parameters or Z-parameters and vice versa, assuming that port no. i is terminated with  $Z_{0i}$  so that the three parameter sets are equivalent and the following formulas apply:

$$Z_{ii} = Z_{0i} \frac{1 + S_{ii}}{1 - S_{ii}}$$

$$Z_{ij} = 2 \frac{\sqrt{Z_{0i} Z_{0j}}}{S_{ij}} - (Z_{0i} + Z_{0j}) \quad \text{for } i \neq j$$

$$Y_{ii} = 1/Z_{ij} = \frac{1}{Z_{0i}} \cdot \frac{1 - S_{ii}}{1 + S_{ii}}$$

$$Y_{ij} = 1/Z_{ij} = \frac{S_{ij}}{2\sqrt{Z_{0i} Z_{0j}} - S_{ij}(Z_{0i} + Z_{0j})} \quad \text{for } i \neq j$$

**Suffix:**

<Chn> Channel number used to identify the active trace

**Parameters:**

<Result> S | Y | Z  
S-parameters, Y-parameters, Z-parameters

**Example:**

```
*RST; CALC:PAR:MEAS 'Trc1'', 'Y-S22'
```

Select the converted admittance Y <-- S22 as measurement parameter of the default trace.

```
CALC:TRAN:COMP S
```

Convert the converted Y-parameter into an S-parameter.

**CALCulate<Chn>:TRANSform:IMPedance:RNORmal <Model>**

Selects the theory for the renormalization of port impedances. The selection has an impact on the conversion formulas for wave quantities and S-parameters.

**Suffix:**

<Chn> Channel number used to identify the active trace

**Parameters:**

<Model> TWAVes | PWAVes  
TWAVes - travelling waves  
PWAVes - power waves  
\*RST: TWAVes

**Example:** See [\[SENSe<Ch>:\] PORT<PhyPt>:ZREFerence](#)

**Manual operation:** See ["Renormalization According to Theory of"](#) on page 383

**CALCulate<Chn>:TRANSform:TIME[:TYPE] <TransformType>**

Selects the time domain transformation type.

**Suffix:**

<Chn> Channel number used to identify the active trace

**Parameters:**

<TransformType> BPASs | LPASs  
 BPASs - band pass impulse (only impulse response; a step response `CALCulate<Chn>:TRANSform:TIME:STIMulus STEP` is automatically changed to impulse response)  
 LPASs - low pass (impulse or step response, depending on `CALCulate<Chn>:TRANSform:TIME:STIMulus` setting)  
 \*RST: BPASs

**Example:**

```
*RST; :CALC:TRAN:TIME:STAT ON
```

Reset the instrument, activating a frequency sweep, and enable the time domain transformation for the default trace.

```
CALC:TRAN:TIME LPAS; TIME:STIM STEP
```

Select a low pass step transformation.

```
CALC:TRAN:TIME:LPAS KFST
```

Calculate a harmonic grid, keeping the stop frequency and the number of points.

**Manual operation:** See "[Type](#)" on page 346

**CALCulate<Chn>:TRANSform:TIME:CENTer <CenterTime>**

Defines the center time of the diagram in time domain.

**Suffix:**

<Chn> Channel number used to identify the active trace

**Parameters:**

<CenterTime> Center time of the diagram in time domain.  
 Range: -99.9999999999 s to +99.9999999999 s  
 Increment: 0.1 ns  
 \*RST: 1.5E-009 s  
 Default unit: s

**Example:**

```
*RST; :CALC:TRAN:TIME:STAT ON
```

Reset the instrument, activating a frequency sweep, and enable the time domain transformation for the default trace.

```
CALC:TRAN:TIME:CENT 0; SPAN 5ns
```

Set the center time to 0 ns and the time span to 5 ns.

**Manual operation:** See "[Time Start / Time Stop / Time Center / Time Span](#)" on page 299

**Note:** If the x-axis is scaled in distance units (`CALCulate<Chn>:TRANSform:TIME:XAXis DISTance`), then the center value is entered in m; the range and default value changes accordingly.



**CALCulate<Chn>:TRANSform:TIME:DCHebyshev <SidebandSup>**

Sets the sideband suppression for the Dolph-Chebyshev window. The command is only available if a Dolph-Chebyshev window is active ([CALCulate<Chn>:TRANSform:TIME:WINDow DCHebyshev](#)).

**Suffix:**

<Chn> Channel number used to identify the active trace

**Parameters:**

<SidebandSup> Sideband suppression  
 Range: 10 dB to 120 dB  
 Increment: 10 dB  
 \*RST: 32 dB  
 Default unit: dB

**Example:**

```
*RST; :CALC:TRAN:TIME:WIND DCH
```

Reset the instrument and select a Dolph-Chebyshev window for filtering the data in the frequency domain.

```
CALC:TRAN:TIME:DCH 25
```

Set the sideband suppression to 25 dB.

**Manual operation:** See "[Side Lobe Level](#)" on page 346

**CALCulate<Chn>:TRANSform:TIME:LPASs <Algorithm>**

Calculates the harmonic grid for low pass time domain transforms according to one of the three alternative algorithms.

**Suffix:**

<Chn> Channel number used to identify the active trace

**Parameters:**

<Algorithm> KFSTop | KDFrequency | KSDFrequency  
 KFSTop - keep stop frequency and number of points  
 KDFrequency - keep frequency gap and number of points  
 KSDfrequency - keep stop frequency and approximate frequency gap

**Example:**

See [CALCulate<Chn>:TRANSform:TIME\[:TYPE\]](#)

**Manual operation:** See "[Set Harmonic Grid and Keep](#)" on page 347

**CALCulate<Chn>:TRANSform:TIME:LPASs:DCSParm <DCValue>**

Defines the DC value for low pass transforms. The command is enabled only if the sweep points are on a harmonic grid (to be set explicitly or using [CALCulate<Chn>:TRANSform:TIME:LPASs](#)).

**Suffix:**

<Chn> Channel number used to identify the active trace

**Parameters:**

<DCValue> DC value of the measured quantity  
 Range: Depending on the measured quantity (-1 to +1 for S-parameters)  
 \*RST: 0

**Example:**

```
*RST; :CALC:TRAN:TIME:STAT ON
```

Reset the instrument, activating a frequency sweep with  $S_{21}$  as measured quantity, and enable the time domain transformation for the default trace.

```
CALC:TRAN:TIME LPAS; TIME:STIM STEP
```

Select a low pass step transformation.

```
CALC:TRAN:TIME:LPAS KFST
```

Calculate a harmonic grid, maintaining the stop frequency and the number of points.

```
CALC:TRAN:TIME:LPAS:DCSP 0.2
```

Set the DC value.

```
CALC:TRAN:TIME:LPAS:DCSP:EXTR; :CALC:TRAN:TIME:LPAS:DCSP?
```

Extrapolate the measured trace, overwrite the defined DC value, and query the new value.

```
CALC:TRAN:TIME:LPAS:DCSP:CONT ON
```

Switch over to continuous extrapolation (e.g. because you noticed a discrepancy between the manually entered DC value and the extrapolation and assume the extrapolation to be more trustworthy).

```
CALC:TRAN:TIME:RES:EFAC 3
```

Select a resolution enhancement factor of 3 in order to improve the resolution in time domain.

**Manual operation:** See ["DC Value"](#) on page 348

**CALCulate<Chn>:TRANSform:TIME:LPASs:DCSPParam:CONTinuous** <Boolean>

Determines whether continuous extrapolation for the DC value is enabled.

**Suffix:**

<Chn> Channel number used to identify the active trace

**Parameters:**

<Boolean> ON - continuous extrapolation enabled  
 OFF - continuous extrapolation disabled  
 \*RST: OFF

**Example:**

See [CALCulate<Chn>:TRANSform:TIME:LPASs:DCSPParam](#)

**Manual operation:** See ["DC Value"](#) on page 348

**CALCulate<Chn>:TRANSform:TIME:LPASs:DCSParam:EXTRapolate**

Extrapolates the measured trace towards  $f = 0$  and overwrites the current DC value (`CALCulate<Chn>:TRANSform:TIME:LPASs:DCSParam`). The command is relevant for low pass time domain transforms.

**Suffix:**

<Chn> Channel number used to identify the active trace

**Example:**

See `CALCulate<Chn>:TRANSform:TIME:LPASs:DCSParam`

**Usage:**

Event

**Manual operation:** See "DC Value" on page 348

**CALCulate<Chn>:TRANSform:TIME:LPFRequency**

Calculates the harmonic grid for low pass time domain transforms, keeping the stop frequency and the number of points.

**Tip:** Use `CALCulate<Chn>:TRANSform:TIME:LPASs` if you wish to use one of the other algorithms for calculating the grid.

**Suffix:**

<Chn> Channel number used to identify the active trace

**Example:**

See `CALCulate<Chn>:TRANSform:TIME[:TYPE]`

**Usage:**

Event

**Manual operation:** See "DC Value" on page 348

**CALCulate<Chn>:TRANSform:TIME:RESolution:EFACtor <REfactor>**

Defines the resolution enhancement factor for the time domain transform.

**Suffix:**

<Chn> Channel number used to identify the active trace

**Parameters:**

<REfactor> Resolution enhancement factor.

Range: 1 to 10.

Increment: 0.1

\*RST: 1 (no resolution enhancement)

**Example:**

See `CALCulate<Chn>:TRANSform:TIME:LPASs:DCSParam`

**Manual operation:** See "Resolution Enh." on page 346

**CALCulate<Chn>:TRANSform:TIME:SPAN <Span>**

Defines the time span of the diagram in time domain.

**Suffix:**

<Chn> Channel number used to identify the active trace

**Parameters:**

<Span> Time span of the diagram in time domain.  
 Range: 2E-012 s to 200 s.  
 Increment: 0.1 ns  
 \*RST: 5E-009 s  
 Default unit: s

**Example:** See `CALCulate<Chn>:TRANSform:TIME:CENTer`

**Manual operation:** See "Time Start / Time Stop / Time Center / Time Span" on page 299

**Note:** If the x-axis is scaled in distance units (`CALCulate<Chn>:TRANSform:TIME:XAXis DISTance`), then the span is entered in m; the range and default value changes accordingly.

**CALCulate<Chn>:TRANSform:TIME:START <StartTime>**

Defines the start time of the diagram in time domain.

**Suffix:**

<Chn> Channel number used to identify the active trace

**Parameters:**

<StartTime> Start time of the diagram.  
 Range: -100 s to +99.999999999998 s.  
 Increment: 0.1 ns  
 \*RST: -1E-009 s  
 Default unit: s

**Example:** `*RST; :CALC:TRAN:TIME:STAT ON`  
 Reset the instrument, activating a frequency sweep, and enable the time domain transformation for the default trace.  
`CALC:TRAN:TIME:STAR 0; STOP 10 ns`  
 Set the start time to 0 ns and the stop time to 10 ns.

**Manual operation:** See "Time Start / Time Stop / Time Center / Time Span" on page 299

**Note:** If the x-axis is scaled in distance units (`CALCulate<Chn>:TRANSform:TIME:XAXis DISTance`), then the start value is entered in m; the range and default value changes accordingly.

**CALCulate<Chn>:TRANSform:TIME:STATe <Boolean>**

Determines whether the time domain transformation for trace no. <Chn> is enabled.

**Suffix:**

<Chn> Channel number used to identify the active trace

**Parameters:**

<Boolean> ON - time domain representation active.  
 OFF - frequency domain representation active.  
 \*RST: OFF

**Example:**

\*RST; :CALC:TRAN:TIME:STAT?

Reset the instrument, activating a frequency sweep, and query whether the default trace is displayed in the time domain. The response is 0.

**Manual operation:** See ["Time Domain"](#) on page 345

**CALCulate<Chn>:TRANSform:TIME:STIMulus <Type>**

Selects the type of stimulus to be simulated in the low pass transformation process.

**Suffix:**

<Chn> Channel number used to identify the active trace

**Parameters:**

<Type> IMPulse | STEP  
 IMPulse - impulse response, in bandpass or lowpass mode.  
 STEP - step response, only in lowpass mode (a bandpass mode setting `CALCulate<Chn>:TRANSform:TIME[:TYPE]` BPASs is automatically changed to lowpass).

\*RST: IMP

**Example:** See `CALCulate<Chn>:TRANSform:TIME[:TYPE]`

**Manual operation:** See ["Type"](#) on page 346

**CALCulate<Chn>:TRANSform:TIME:STOP <StopTime>**

Defines the stop time of the diagram in time domain.

**Suffix:**

<Chn> Channel number used to identify the active trace

**Parameters:**

<StopTime> Stop time of the diagram.  
 Range: -99.9999999999998 s to +100 s.  
 Increment: 0.1 ns  
 \*RST: +4E-009 s  
 Default unit: s

**Example:** See `CALCulate<Chn>:TRANSform:TIME:START`

**Manual operation:** See ["Time Start / Time Stop / Time Center / Time Span"](#) on page 299

**Note:** If the x-axis is scaled in distance units (`CALCulate<Chn>:TRANSform:TIME:XAXis DISTance`), then the stop value is entered in m; the range and default value changes accordingly.

**CALCulate<Chn>:TRANSform:TIME:WINDow <WindowType>**

Selects the window type for filtering the data in the frequency domain prior to the time domain transformation.

**Suffix:**

<Chn> Channel number used to identify the active trace

**Parameters:**

<WindowType> RECT | HAMMing | HANNing | BOHMan | DCHebyshev  
 RECT - no profiling (rectangle)  
 HANN - normal profile (Hann)  
 HAMMing - low first sidelobe (Hamming)  
 BOHMan - steep falloff (Bohman)  
 DCHebyshev - arbitrary sidelobes (Dolph-Chebyshev)  
 \*RST: HANN

**Example:** See [CALCulate<Chn>:TRANSform:TIME:DCHebyshev](#)

**Manual operation:** See "[Impulse Response](#)" on page 346

**CALCulate<Chn>:TRANSform:TIME:XAXis <Unit>**

Switches over between the x-axis scaling in time units or distance units.

**Suffix:**

<Chn> Channel number used to identify the active trace

**Parameters:**

<Unit> TIME | DISTance  
 TIME - x-axis scaled in time units.  
 DISTance - x-axis scaled in distance units (Distance = Time \*  $c_0$   
 \* Velocity Factor).

**Example:** \*RST; :CALC:TRAN:TIME:STAT ON  
 Reset the instrument, activating a frequency sweep, and enable the time domain transformation for the default trace.  
 CALC:TRAN:TIME:XAX DIST  
 Convert the x-axis scaling to distance units.

**Manual operation:** See "[Time / Distance](#)" on page 300

**CALCulate:TRANSform:DTFault...**

The `CALCulate:TRANSform:DTFault...` commands set up and control a distance to fault measurement (with option R&S ZNL-K3).



For the R&S ZNLE the Distance to Fault option K3 is not available.

|                                                          |     |
|----------------------------------------------------------|-----|
| CALCulate<Chn>:TRANSform:DTFault:DEFine.....             | 695 |
| CALCulate<Chn>:TRANSform:DTFault:DELeTe.....             | 696 |
| CALCulate<Chn>:TRANSform:DTFault:SELEct.....             | 696 |
| CALCulate<Chn>:TRANSform:DTFault:CENTer.....             | 696 |
| CALCulate<Chn>:TRANSform:DTFault:SPAN.....               | 696 |
| CALCulate<Chn>:TRANSform:DTFault:PEAK:COUNT?.....        | 697 |
| CALCulate<Chn>:TRANSform:DTFault:PEAK:DATA<FaultNo>..... | 697 |
| CALCulate<Chn>:TRANSform:DTFault:PEAK:STATE.....         | 698 |
| CALCulate<Chn>:TRANSform:DTFault:PEAK:THReshold.....     | 698 |
| CALCulate<Chn>:TRANSform:DTFault:POINts.....             | 699 |
| CALCulate<Chn>:TRANSform:DTFault:START.....              | 699 |
| CALCulate<Chn>:TRANSform:DTFault:STOP.....               | 699 |
| CALCulate<Chn>:TRANSform:DTFault:STATE.....              | 700 |

---

**CALCulate<Chn>:TRANSform:DTFault:DEFine** <CblName>, <CblPermittivity>, <CblAtt1>, <CblFreq1>{, <CblAtt2>, <CblFreq2>}...

Defines a new user-defined cable type for Distance to Fault (DtF) measurements.

The cable's frequency-dependent attenuation is defined via attenuation/frequency pairs <CblAtt1>, <CblFreq1>, <CblAtt2>, <CblFreq2>, ... . At least one pair has to be specified.

**Suffix:**

<Chn> Channel number  
This suffix is ignored: cable types are defined for all channels.

**Setting parameters:**

<CblName> Name of the cable type.  
Must be unique among all DtF cable types, with case insensitive match.

<CblPermittivity> Relative permittivity  $\epsilon_r$  of the cable type.

<CblAtt[i]> Attenuation value  $i$  in the frequency-dependent attenuation table of the cable type.  
Default unit: dB/m

<CblFreq[i]> Frequency  $i$  in the frequency-dependent attenuation table of the cable type.  
Default unit: Hz

**Example:**

```
CALCulate:TRANSform:DTFault:DEFine 'My cable
type', 1.1, 0.01, 1GHz, 0.015, 2GHz, 0.012,
3GHz
```

Defines a new cable type "My cable type" with relative permittivity  $\epsilon_r=1.1$  and the frequency-dependent attenuation given in the table below.

**Usage:** Setting only

**Options:** R&S ZNL-K3

**Manual operation:** See "Add / Delete" on page 357

Table 11-8: Example: frequency-dependent attenuation table

| [i] | Frequency | Attenuation |
|-----|-----------|-------------|
| 1   | 1 GHz     | 0.01 dB/m   |
| 2   | 2 GHz     | 0.015 dB/m  |
| 3   | 3 GHz     | 0.012 dB/m  |

**CALCulate<Chn>:TRANSform:DTFault:DELeTe <DtfDeleteCable>**

Deletes the user-defined cable type with the given name.

**Suffix:**

<Chn> Channel number  
This suffix is ignored: cable types are defined for (and deleted from) all channels.

**Setting parameters:**

<DtfDeleteCable> Name of a user-defined cable type.

**Example:**

CALCulate:TRANSform:DTFault:DELeTe 'My cable type'  
Deletes the user-defined cable type "My cable type".

**Usage:**

Setting only

**Options:**

R&S ZNL-K3

**Manual operation:** See ["Add / Delete"](#) on page 357

**CALCulate<Chn>:TRANSform:DTFault:SELeCt <DtfSelectCable>**

Selects one of the available (predefined or user-defined) cable types for Distance to Fault measurements.

**Suffix:**

<Chn> Channel number used to identify the active trace.

**Parameters:**

<DtfSelectCable> Name of the cable type.

**Example:**

CALCulate1:TRANSform:DTFault:SELeCt '5088-HFLR'  
Selects cable type "5088-HFLR".

**Options:**

R&S ZNL-K3

**Manual operation:** See ["Cable Type..."](#) on page 354

**CALCulate<Chn>:TRANSform:DTFault:CENTer <Center>****CALCulate<Chn>:TRANSform:DTFault:SPAN <Span>**

Defines the distance window of the Distance to Fault measurement using its center and span.



See also `CALCulate<Chn>:TRANSform:DTFault:START` and `CALCulate<Chn>:TRANSform:DTFault:STOP`.

**Suffix:**

<Chn> Channel number used to identify the active trace.

**Parameters:**

<Center>/<Span> Center/span value.  
Default unit: m

**Example:**

```
:CALCulate1:TRANSform:DTFault:CENTer 2; SPAN 2
```

Defines the DtF distance window of the active trace of channel 1 via its center (2m) and span (2m).

**Options:**

R&S ZNL-K3

**Manual operation:** See "[Start Distance / Stop Distance](#)" on page 353

**CALCulate<Chn>:TRANSform:DTFault:PEAK:COUNT?**

If the active trace of channel <Chn> is a Distance to Fault (DtF) trace and DtF limit checking is enabled, this query returns the number of DtF limit violations of this trace.

Use `CALCulate<Chn>:TRANSform:DTFault:PEAK:STATE` to enable DtF limit checking and `CALCulate<Chn>:TRANSform:DTFault:PEAK:THReshold` to set the fault limit.

**Suffix:**

<Chn> Channel number used to identify the active trace

**Usage:**

Query only

**Options:**

R&S ZNL-K3

**Manual operation:** See "[Fault Table](#)" on page 358

**CALCulate<Chn>:TRANSform:DTFault:PEAK:DATA<FaultNo>**

If the active trace of channel <Chn> is a Distance to Fault (DtF) trace and DtF limit checking is enabled, this query returns the peak data of DtF limit violation <FaultNo>

<FaultNo> must be between 1 and `CALCulate<Chn>:TRANSform:DTFault:PEAK:COUNT?`. The peak data are returned as value pair *distance, response value*. Peaks are numbered according to their distance (fault no. 1 has the smallest distance).

Use `CALCulate<Chn>:TRANSform:DTFault:PEAK:STATE` to enable DtF limit checking and `CALCulate<Chn>:TRANSform:DTFault:PEAK:THReshold` to set the fault limit.

**Suffix:**

<Chn> Channel number used to identify the active trace

<FaultNo>

1 ... `CALCulate<Chn>:TRANSform:DTFault:PEAK:COUNT?`

- Example:** Suppose `CALCulate1:TRANSform:DTFault:PEAK:COUNT?` returns 3, then  
`CALCulate1:TRANSform:DTFault:PEAK:DATA1; DATA2; DATA3`  
returns the coordinates of the DtF limit violation peaks.
- Options:** R&S ZNL-K3
- Manual operation:** See "[Fault Table](#)" on page 358

#### **CALCulate<Chn>:TRANSform:DTFault:PEAK:STATE <DtfPeakState>**

If the active trace of channel <Chn> is a Distance to Fault (DtF) trace, this command allows to enable/disable DtF limit checking.

- Suffix:**  
<Chn> Channel number used to identify the active trace
- Parameters:**  
<DtfPeakState> OFF|ON (0|1)
- Example:** `*RST; :CALCulate1:TRANSform:DTFault:STATE ON`  
makes the active trace of channel 1 a DtF trace.  
`CALCulate1:TRANSform:DTFault:PEAK:STATE ON`  
enables DtF limit checking.
- Options:** R&S ZNL-K3
- Manual operation:** See "[Fault Limit Check](#)" on page 355

#### **CALCulate<Chn>:TRANSform:DTFault:PEAK:THReshold <PeakThreshold>**

If the active trace of channel <Chn> is a Distance to Fault (DtF) trace, this command allows to set the fault limit for DtF limit checking.

Use `CALCulate<Chn>:TRANSform:DTFault:PEAK:STATE` to enable DtF limit checking.

- Suffix:**  
<Chn> Channel number used to identify the active trace
- Parameters:**  
<PeakThreshold> Fault limit  
`*RST: -20 dB`  
Default unit: dB
- Example:** `*RST; :CALCulate1:TRANSform:DTFault:STATE ON`  
makes the active trace of channel 1 a DtF trace.  
`CALCulate1:TRANSform:DTFault:PEAK:THReshold -30`  
sets the DtF limit to -30 dB.
- Options:** R&S ZNL-K3
- Manual operation:** See "[Fault Limit](#)" on page 356

**CALCulate<Chn>:TRANSform:DTFault:POINTs**

If the active trace of channel <Chn> is a Distance to Fault (DtF) trace, this command starts the "Auto Number of Points" calculation (see ["Auto Number of Points"](#) on page 354).

An execution error is raised, if the calculated number of points is higher than the maximum number of sweep points the firmware allows (100001). To avoid this, reduce the frequency span  $\Delta f$  (see [\[SENSe<Ch>:\]SWEep:POINTs](#) on page 902) and/or the stop frequency  $d_{\text{stop}}$  (see [CALCulate<Chn>:TRANSform:DTFault:STOP](#)) so that

$$2.6 \cdot d_{\text{stop}} \cdot \Delta f / (v \cdot c_0) \leq 100001 ,$$

where  $v$  denotes the velocity factor of the measured cable (see [CALCulate<Chn>:TRANSform:DTFault:SElect](#)).

**Suffix:**

<Chn> Channel number used to identify the active trace

**Example:**

```
*RST; :CALCulate1:TRANSform:DTFault:STATE ON
makes the active trace of channel 1 a DtF trace.
SENSe1:SWEep:POINTs?
returns the default number of sweep points (201).
:CALCulate1:TRANSform:DTFault:START 0; STOP 100
widens the DtF distance window to 100m.
CALCulate1:TRANSform:DTFault:POINTs
starts the "Auto Number of Points calculation". Now
SENSe1:SWEep:POINTs?
returns an increased number of sweep points.
```

**Usage:** Event

**Options:** R&S ZNL-K3

**Manual operation:** See ["Auto Number of Points"](#) on page 354

**CALCulate<Chn>:TRANSform:DTFault:START <Start>****CALCulate<Chn>:TRANSform:DTFault:STOP <Stop>**

Defines the window of the Distance to Fault measurement using its start and stop distance.

See also [CALCulate<Chn>:TRANSform:DTFault:CENTER](#) and [CALCulate<Chn>:TRANSform:DTFault:SPAN](#).

**Suffix:**

<Chn> Channel number used to identify the active trace

**Parameters:**

<Start>/<Stop> Start/stop distance.  
Default unit: m

**Example:**

```
:CALCulate1:TRANSform:DTFault:START 1; STOP 3
Defines the DtF distance window of the active trace of channel 1
as [1m, 3m].
```

**Options:** R&S ZNL-K3

**Manual operation:** See "[Start Distance / Stop Distance](#)" on page 353

#### **CALCulate<Chn>:TRANSform:DTFault:STATe <DtfState>**

If channel <Chn> is performing an unsegmented frequency sweep, this command allows to transform its active trace into a Distance to Fault (DtF) trace.

**Suffix:**

<Chn> Channel number used to identify the active trace

**Parameters:**

<DtfState> OFF|ON – DtF disabled|enabled

\*RST: OFF

**Example:**

:CALCulate1:TRANSform:DTFault:STATe ON  
turns the DtF representation of the active trace of channel 1 ON.

**Options:** R&S ZNL-K3

**Manual operation:** See "[Distance to Fault](#)" on page 352

#### **CALCulate:TRANSform:VNETworks...**

The CALCulate:TRANSform:VNETworks... commands define and activate the circuit models for the different de-/embedding types. See [Chapter 9.6.2, "Embedding and Deembedding"](#), on page 271 .

The circuit models are addressed by predefined enum constants. Except for the FIM-Port model, that consists of a single snp file, the models and constants are different for the different de-/embedding types.

**Table 11-9: Circuit models for single ended port embedding/deembedding**

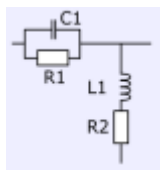
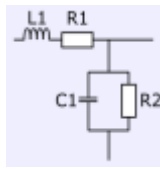
| Parameter | Circuit model                                  | Pictogram                                                                             |
|-----------|------------------------------------------------|---------------------------------------------------------------------------------------|
| FIMPort   | File import, generic 2-port (no circuit model) |  |
| CSL       | Serial C, shunt L                              |  |
| LSC       | Serial L, shunt C                              |  |

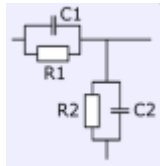
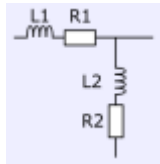
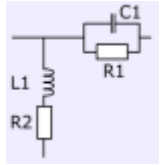
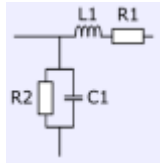
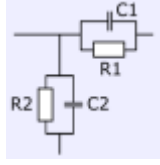
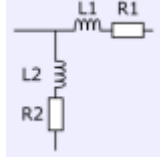
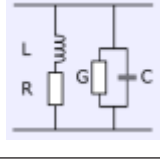
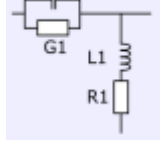
| Parameter | Circuit model     | Pictogram                                                                             |
|-----------|-------------------|---------------------------------------------------------------------------------------|
| CSC       | Serial C, shunt C |    |
| LSL       | Serial L, shunt L |    |
| SLC       | Shunt L, serial C |    |
| SCL       | Shunt C, serial L |   |
| SCC       | Shunt C, serial C |  |
| SLL       | Shunt L, serial L |  |
| SHLC      | Shunt L, shunt C  |  |
| GSL       | Serial C, shunt L |  |



| Parameter | Circuit model     | Pictogram                                                                             |
|-----------|-------------------|---------------------------------------------------------------------------------------|
| LSG       | Serial L, shunt C |    |
| GSG       | Serial C, shunt C |    |
| SGL       | Shunt C, serial L |    |
| SLG       | Shunt L, serial C |   |
| SGG       | Shunt C, serial C |  |

Table 11-10: Circuit models for balanced port (and port pair) de-embedding

| Parameter | Circuit model                                        | Pictogram                                                                             |
|-----------|------------------------------------------------------|---------------------------------------------------------------------------------------|
| FIMPort   | File import, generic 4-port (.s4p, no circuit model) |  |
| STSL      | Serial Touchstone (.s2p) data, shunt L               |  |
| STSC      | Serial Touchstone (.s2p) data, shunt C               |  |

| Parameter | Circuit model                          | Pictogram                                                                             |
|-----------|----------------------------------------|---------------------------------------------------------------------------------------|
| SLST      | Shunt L, serial Touchstone (.s2p) data |    |
| SCST      | Shunt C, serial Touchstone (.s2p) data |    |
| CSSL      | Serial Cs, shunt L                     |    |
| LSSC      | Serial Ls, shunt C                     |   |
| CSSC      | Serial Cs, shunt C                     |  |
| LSSL      | Serial Ls, shunt L                     |  |
| SLCS      | Shunt L, serial Cs                     |  |
| SCLS      | Shunt C, serial Ls                     |  |

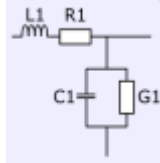
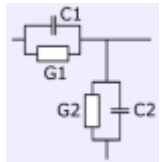
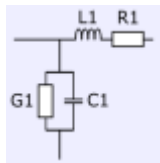
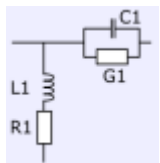
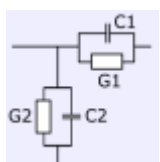
| Parameter | Circuit model                          | Pictogram                                                                             |
|-----------|----------------------------------------|---------------------------------------------------------------------------------------|
| SCCS      | Shunt C, serial Cs                     |    |
| SLLS      | Shunt L, serial Ls                     |    |
| STSG      | Serial Touchstone (.s2p) data, shunt C |    |
| SGST      | Shunt C, serial Touchstone (.s2p) data |   |
| GSSL      | Serial Cs, shunt L                     |  |
| LSSG      | Serial Ls, shunt C                     |  |
| GSSG      | Serial Cs, shunt C                     |  |
| SLGS      | Shunt L, serial Cs                     |  |

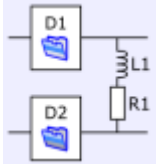
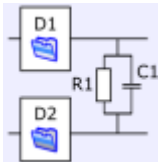
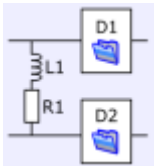
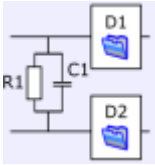
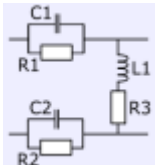
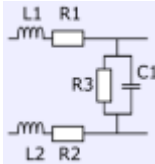
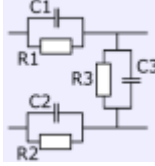
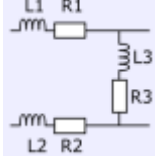
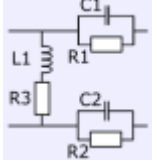
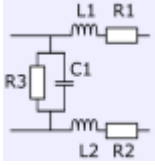
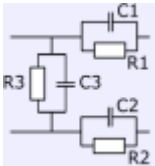
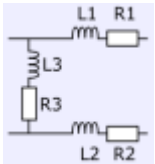
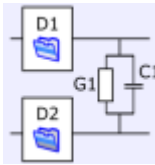
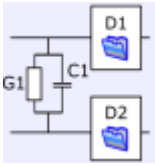
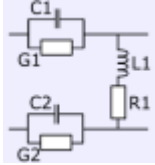
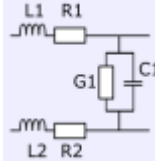
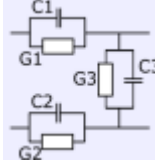
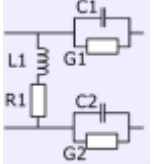

| Parameter | Circuit model      | Pictogram                                                                           |
|-----------|--------------------|-------------------------------------------------------------------------------------|
| SGLS      | Shunt C, serial Ls |  |
| SGGS      | Shunt C, serial Cs |  |

Table 11-11: Circuit models for port set de-/embedding

| Parameter       | Circuit model                                                                                                                              | Pictogram                                                                           |
|-----------------|--------------------------------------------------------------------------------------------------------------------------------------------|-------------------------------------------------------------------------------------|
| FIMPort         | File import, no circuit model                                                                                                              |  |
| STSL, ..., SGGS | The models for port pairs (i.e. port sets with two ports) are the same as the ones for balanced ports<br>See <a href="#">Table 11-10</a> . |                                                                                     |

Table 11-12: Circuit models for ground loop de-/embedding

| Parameter | Circuit model                 | Pictogram                                                                             |
|-----------|-------------------------------|---------------------------------------------------------------------------------------|
| FIMPort   | File import, no circuit model |  |
| SL        | Shunt L                       |  |

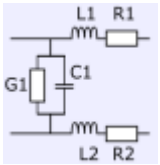
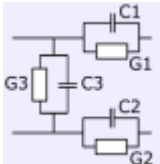

| Parameter | Circuit model | Pictogram                                                                           |
|-----------|---------------|-------------------------------------------------------------------------------------|
| SC        | Shunt C       |  |
| SG        | Shunt C       |  |

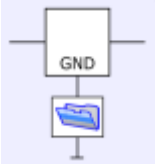
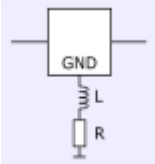
Table 11-13: Circuit models for differential match embedding

| Parameter | Circuit model                                  | Pictogram                                                                             |
|-----------|------------------------------------------------|---------------------------------------------------------------------------------------|
| FIMPort   | File import, generic 2-port (no circuit model) |   |
| SHLC      | Shunt L, shunt C                               |  |

CALCulate<Ch>:TRANSform:VNETworks:BALanced:DEEMbedding<LogPt>[:STATE]..... 708

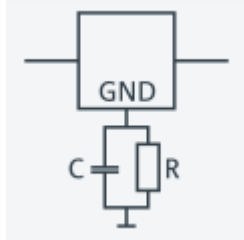
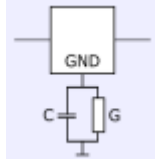
CALCulate<Ch>:TRANSform:VNETworks:BALanced:DEEMbedding<LogPt>:  
 PARAmeters:C<Cmp>..... 709

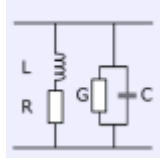
CALCulate<Ch>:TRANSform:VNETworks:BALanced:DEEMbedding<LogPt>:  
 PARAmeters:DATA<Port>..... 709

CALCulate<Ch>:TRANSform:VNETworks:BALanced:DEEMbedding<LogPt>:  
 PARAmeters:G<Cmp>..... 710

CALCulate<Ch>:TRANSform:VNETworks:BALanced:DEEMbedding<LogPt>:  
 PARAmeters:L<Cmp>..... 711

CALCulate<Ch>:TRANSform:VNETworks:BALanced:DEEMbedding<LogPt>:  
 PARAmeters:R<Cmp>..... 712

CALCulate<Ch>:TRANSform:VNETworks:BALanced:DEEMbedding<LogPt>:TNDefinition.... 713

CALCulate<Ch>:TRANSform:VNETworks:BALanced:EMBedding<LogPt>[:STATE]..... 713

CALCulate<Ch>:TRANSform:VNETworks:BALanced:EMBedding<LogPt>:PARAmeters:  
 C<Cmp>..... 714

CALCulate<Ch>:TRANSform:VNETworks:BALanced:EMBedding<LogPt>:PARAmeters:  
 DATA<Port>..... 714

CALCulate<Ch>:TRANSform:VNETworks:BALanced:EMBedding<LogPt>:PARAmeters:  
 G<Cmp>..... 715

|                                                                                            |     |
|--------------------------------------------------------------------------------------------|-----|
| CALCulate<Ch>:TRANSform:VNETworks:BALanced:EMBedding<LogPt>:PARAmeters:<br>L<Cmp>.....     | 716 |
| CALCulate<Ch>:TRANSform:VNETworks:BALanced:EMBedding<LogPt>:PARAmeters:<br>R<Cmp>.....     | 717 |
| CALCulate<Ch>:TRANSform:VNETworks:BALanced:EMBedding<LogPt>:TNDefinition.....              | 718 |
| CALCulate<Ch>:TRANSform:VNETworks:DIFFerential:EMBedding<LogPt>[:STATe].....               | 718 |
| CALCulate<Ch>:TRANSform:VNETworks:DIFFerential:EMBedding<LogPt>:<br>PARAmeters:C<Cmp>..... | 718 |
| CALCulate<Ch>:TRANSform:VNETworks:DIFFerential:EMBedding<LogPt>:<br>PARAmeters:DATA.....   | 719 |
| CALCulate<Ch>:TRANSform:VNETworks:DIFFerential:EMBedding<LogPt>:<br>PARAmeters:G<Cmp>..... | 719 |
| CALCulate<Ch>:TRANSform:VNETworks:DIFFerential:EMBedding<LogPt>:<br>PARAmeters:L<Cmp>..... | 720 |
| CALCulate<Ch>:TRANSform:VNETworks:DIFFerential:EMBedding<LogPt>:<br>PARAmeters:R<Cmp>..... | 720 |
| CALCulate<Ch>:TRANSform:VNETworks:DIFFerential:EMBedding<LogPt>:TNDefinition.....          | 721 |
| CALCulate<Ch>:TRANSform:VNETworks:GLOop:DEEMbedding[:STATe].....                           | 721 |
| CALCulate<Ch>:TRANSform:VNETworks:GLOop:DEEMbedding:PARAmeters:C.....                      | 722 |
| CALCulate<Ch>:TRANSform:VNETworks:GLOop:DEEMbedding:PARAmeters:G.....                      | 722 |
| CALCulate<Ch>:TRANSform:VNETworks:GLOop:DEEMbedding:PARAmeters:L.....                      | 723 |
| CALCulate<Ch>:TRANSform:VNETworks:GLOop:DEEMbedding:PARAmeters:R.....                      | 723 |
| CALCulate<Ch>:TRANSform:VNETworks:GLOop:DEEMbedding:TNDefinition.....                      | 724 |
| CALCulate<Ch>:TRANSform:VNETworks:GLOop:EMBedding[:STATe].....                             | 724 |
| CALCulate<Ch>:TRANSform:VNETworks:GLOop:EMBedding:PARAmeters:C.....                        | 725 |
| CALCulate<Ch>:TRANSform:VNETworks:GLOop:EMBedding:PARAmeters:G.....                        | 725 |
| CALCulate<Ch>:TRANSform:VNETworks:GLOop:EMBedding:PARAmeters:L.....                        | 726 |
| CALCulate<Ch>:TRANSform:VNETworks:GLOop:EMBedding:PARAmeters:R.....                        | 726 |
| CALCulate<Ch>:TRANSform:VNETworks:GLOop:EMBedding:TNDefinition.....                        | 727 |
| CALCulate<Ch>:TRANSform:VNETworks:FSIMulator[:STATe].....                                  | 727 |
| CALCulate<Ch>:TRANSform:VNETworks:PPAir:DEEMbedding:DELeTe.....                            | 727 |
| CALCulate<Ch>:TRANSform:VNETworks:PPAir:DEEMbedding<ListId>[:STATe].....                   | 728 |
| CALCulate<Ch>:TRANSform:VNETworks:PPAir:DEEMbedding<ListId>:DEFine.....                    | 728 |
| CALCulate<Ch>:TRANSform:VNETworks:PPAir:DEEMbedding<ListId>:PARAmeters:<br>C<1 2 3>.....   | 729 |
| CALCulate<Ch>:TRANSform:VNETworks:PPAir:DEEMbedding<ListId>:PARAmeters:<br>G<1 2 3>.....   | 730 |
| CALCulate<Ch>:TRANSform:VNETworks:PPAir:DEEMbedding<ListId>:PARAmeters:<br>L<1 2 3>.....   | 730 |
| CALCulate<Ch>:TRANSform:VNETworks:PPAir:DEEMbedding<ListId>:PARAmeters:<br>R<1 2 3>.....   | 731 |
| CALCulate<Ch>:TRANSform:VNETworks:PPAir:DEEMbedding<ListId>:TNDefinition.....              | 732 |
| CALCulate<Ch>:TRANSform:VNETworks:PPAir:EMBedding<ListId>[:STATe].....                     | 732 |
| CALCulate<Ch>:TRANSform:VNETworks:PPAir:EMBedding<ListId>:DEFine.....                      | 733 |
| CALCulate<Ch>:TRANSform:VNETworks:PPAir:EMBedding<ListId>:DELeTe.....                      | 733 |
| CALCulate<Ch>:TRANSform:VNETworks:PPAir:EMBedding<ListId>:PARAmeters:C<1 2 3>..            | 734 |
| CALCulate<Ch>:TRANSform:VNETworks:PPAir:EMBedding<ListId>:PARAmeters:L<1 2 3>..            | 735 |
| CALCulate<Ch>:TRANSform:VNETworks:PPAir:EMBedding<ListId>:PARAmeters:R<1 2 3>..            | 735 |
| CALCulate<Ch>:TRANSform:VNETworks:PPAir:EMBedding<ListId>:PARAmeters:G<1 2 3>..            | 736 |
| CALCulate<Ch>:TRANSform:VNETworks:PPAir:EMBedding<ListId>:TNDefinition.....                | 737 |

|                                                                                        |     |
|----------------------------------------------------------------------------------------|-----|
| CALCulate<Ch>:TRANSform:VNETworks:PSET:DEEMbedding<ListId>:DEFine.....                 | 737 |
| CALCulate<Ch>:TRANSform:VNETworks:PSET:EMBedding<ListId>:DEFine.....                   | 737 |
| CALCulate<Ch>:TRANSform:VNETworks:SENDEd:DEEMbedding<PhyPt>[:STATe].....               | 738 |
| CALCulate<Ch>:TRANSform:VNETworks:SENDEd:DEEMbedding<PhyPt>:<br>PARAmeters:DATA.....   | 738 |
| CALCulate<Ch>:TRANSform:VNETworks:SENDEd:DEEMbedding<PhyPt>:<br>PARAmeters:C<Cmp>..... | 739 |
| CALCulate<Ch>:TRANSform:VNETworks:SENDEd:DEEMbedding<PhyPt>:<br>PARAmeters:G<Cmp>..... | 740 |
| CALCulate<Ch>:TRANSform:VNETworks:SENDEd:DEEMbedding<PhyPt>:<br>PARAmeters:L<Cmp>..... | 741 |
| CALCulate<Ch>:TRANSform:VNETworks:SENDEd:DEEMbedding<PhyPt>:<br>PARAmeters:R<Cmp>..... | 741 |
| CALCulate<Ch>:TRANSform:VNETworks:SENDEd:DEEMbedding<PhyPt>:TNDefinition.....          | 742 |
| CALCulate<Ch>:TRANSform:VNETworks:SENDEd:EMBedding<PhyPt>[:STATe].....                 | 742 |
| CALCulate<Ch>:TRANSform:VNETworks:SENDEd:EMBedding<PhyPt>:PARAmeters:<br>DATA.....     | 743 |
| CALCulate<Ch>:TRANSform:VNETworks:SENDEd:EMBedding<PhyPt>:PARAmeters:<br>C<Cmp>.....   | 744 |
| CALCulate<Ch>:TRANSform:VNETworks:SENDEd:EMBedding<PhyPt>:PARAmeters:<br>G<Cmp>.....   | 744 |
| CALCulate<Ch>:TRANSform:VNETworks:SENDEd:EMBedding<PhyPt>:PARAmeters:<br>L<Cmp>.....   | 745 |
| CALCulate<Ch>:TRANSform:VNETworks:SENDEd:EMBedding<PhyPt>:PARAmeters:<br>R<Cmp>.....   | 746 |
| CALCulate<Ch>:TRANSform:VNETworks:SENDEd:EMBedding<PhyPt>:TNDefinition.....            | 747 |

---

### CALCulate<Ch>:TRANSform:VNETworks:BALanced:DEEMbedding<LogPt>[: STATe] <Boolean>

Enables or disables the deembedding function for balanced ports. It is allowed to change the circuit model and its parameters while deembedding is enabled.

**Suffix:**

|         |                                     |
|---------|-------------------------------------|
| <Ch>    | Channel number                      |
| <LogPt> | Logical port number (balanced port) |

**Parameters:**

|           |                                                       |
|-----------|-------------------------------------------------------|
| <Boolean> | ON - deembedding active<br>OFF - deembedding inactive |
| *RST:     | OFF                                                   |

**Example:**

```
*RST; SOUR:LPOR1 1,2; LPOR2 3,4
Define a balanced port configuration.
CALC:TRAN:VNET:BAL:DEEM:TND CSSL
Select the Serial Cs, shunt L circuit model for deembedding.
CALC:TRAN:VNET:BAL:DEEM:PAR:R3 CSSL, 2.2E+3; :
CALC:TRAN:VNET:BAL:DEEM ON
Increase the resistance R3 for the Serial Cs, shunt L circuit
model to 2.2 kΩ and enable deembedding.
```

**Manual operation:** See ["Active"](#) on page 496

---

**CALCulate<Ch>:TRANSform:VNETworks:BALanced:DEEMbedding<LogPt>:  
PARAmeters:C<Cmp>** <CircuitModel>, <Capacitance>  
**CALCulate<Ch>:TRANSform:VNETworks:BALanced:DEEMbedding<LogPt>:  
PARAmeters:C<Cmp>?** <CircuitModel>

Specifies the capacitance value C<Cmp> in the different circuit models for balanced port deembedding.

In the query form, the <Capacitance> parameter must be omitted. The command returns the capacitance value for the specified circuit model.

**Suffix:**

|         |                                                                                                                 |
|---------|-----------------------------------------------------------------------------------------------------------------|
| <Ch>    | Channel number                                                                                                  |
| <LogPt> | Logical port number (balanced port)                                                                             |
| <Cmp>   | Number of capacitance in circuit model. The total number of capacitances depends on the selected circuit model. |

**Parameters:**

|               |                                                                                                                                                     |
|---------------|-----------------------------------------------------------------------------------------------------------------------------------------------------|
| <Capacitance> | Capacitance C<Cmp> for the specified circuit model.<br>Range: -1mF to 1 mF.<br>Increment: 1 fF (1E-15 F)<br>*RST: 1 pF (1E-12 F)<br>Default unit: F |
|---------------|-----------------------------------------------------------------------------------------------------------------------------------------------------|

**Parameters for setting and query:**

|                |                                                                                                                                                                                              |
|----------------|----------------------------------------------------------------------------------------------------------------------------------------------------------------------------------------------|
| <CircuitModel> | STSC   SCST   CSSL   LSSC   CSSC   SLCS   SCLS   SCCS   STSG   SGST   GSSL   LSSG   GSSG   SLGS   SGLS   SGGS<br>Possible circuit models (character data); see <a href="#">Table 11-10</a> . |
|----------------|----------------------------------------------------------------------------------------------------------------------------------------------------------------------------------------------|

**Example:**

```
*RST; :SOUR:LPOR1 1,2; :CALC:TRAN:VNET:BAL:
DEEM:PAR:C2? CSSL
Create a balanced port and query the default capacitance C2 for
the Serial Cs, shunt L circuit model. The response is 1E-012 (1
pF).
CALC:TRAN:VNET:BAL:DEEM:PAR:C2 CSSL, 2.2E-12
Increase the capacitance to 2.2 pF.
```

**Manual operation:** See ["Network"](#) on page 513

---

**CALCulate<Ch>:TRANSform:VNETworks:BALanced:DEEMbedding<LogPt>:  
PARAmeters:DATA<Port>** <Interchange>, <arg1>

Defines a deembedding network for a balanced port based on the given S-Parameter traces.

Circuit models STSL | STSC | SLST | SCST require S-Parameter traces of two 2-port networks, to be assigned to the different ports PMAin and PSECondary; the FIMPort model requires S-Parameter traces of a single 4-port network but no additional port assignment.

## Use

- `CALCulate<Ch>:TRANSform:VNETworks:BALanced:DEEMbedding<LogPt>:TNDefinition` to select the adequate circuit model **before** executing this command.
- `MMEMory:LOAD:VNETworks<Ch>:BALanced:DEEMbedding<LogPt>` to load circuit data from a Touchstone file located at the R&S ZNL/ZNLE's file system.

**Suffix:**

|         |                                                                                                                        |
|---------|------------------------------------------------------------------------------------------------------------------------|
| <Ch>    | Channel number                                                                                                         |
| <LogPt> | Logical port number                                                                                                    |
| <Port>  | Port assignment for two 2-port networks:<br>1 - Port 1<br>2 - Port 2<br>This parameter is ignored for 4-port networks. |

**Setting parameters:**

|               |                                                                                                                                                                                                                                                                                                                                                                                                                                                                                                                                                                                                                               |
|---------------|-------------------------------------------------------------------------------------------------------------------------------------------------------------------------------------------------------------------------------------------------------------------------------------------------------------------------------------------------------------------------------------------------------------------------------------------------------------------------------------------------------------------------------------------------------------------------------------------------------------------------------|
| <Interchange> | FPORts   IPORts   SGATes   SINcreasing<br><b>FPORts (or omitted)</b><br>Standard port sequence (odd port numbers towards VNA, even port numbers towards DUT)<br><b>IPORts</b><br>– Two-port networks: inverted port sequence (network port 2 towards VNA, network port 1 towards DUT)<br>– Four-port networks: increasing port sequence (low port numbers towards VNA, high port numbers towards DUT)<br><b>SGATes</b><br>Swapped gates (even port numbers towards VNA, odd port numbers towards DUT)<br><b>SINcreasing</b><br>Swapped increasing port sequence (high port numbers towards VNA, low port numbers towards DUT) |
| <arg1>        | <block_data><br>Content of a Touchstone file (*.s2p or *.s4p) in IEEE488.2 <a href="#">Block Data Format</a> .                                                                                                                                                                                                                                                                                                                                                                                                                                                                                                                |

**Usage:** Setting only

---

**CALCulate<Ch>:TRANSform:VNETworks:BALanced:DEEMbedding<LogPt>:PARAMeters:G<Cmp>** <CircuitModel>, <Conductance>  
**CALCulate<Ch>:TRANSform:VNETworks:BALanced:DEEMbedding<LogPt>:PARAMeters:G<Cmp>?** <CircuitModel>

Specifies the conductance value G<Cmp> in the different circuit models for balanced port deembedding.

In the query form, the <Conductance> parameter must be omitted. The command returns the capacitance value for the specified circuit model.

**Suffix:**

|         |                                                                                                                 |
|---------|-----------------------------------------------------------------------------------------------------------------|
| <Ch>    | Channel number                                                                                                  |
| <LogPt> | Logical port number (balanced port)                                                                             |
| <Cmp>   | Number of conductance in circuit model. The total number of conductances depends on the selected circuit model. |

**Parameters:**

|               |                                                                                                                                                                   |
|---------------|-------------------------------------------------------------------------------------------------------------------------------------------------------------------|
| <Conductance> | Conductance G<Cmp> for the specified circuit model.<br>Range: -1kS to 1 kS.<br>Increment: 1 nS (1E-9 S)<br>*RST: 0 S<br>Default unit: Siemens (SI unit symbol: S) |
|---------------|-------------------------------------------------------------------------------------------------------------------------------------------------------------------|

**Parameters for setting and query:**

|                |                                                                                                                                      |
|----------------|--------------------------------------------------------------------------------------------------------------------------------------|
| <CircuitModel> | STSG   SGST   GSSL   LSSG   GSSG   SLGS   SGLS   SGGS<br>Possible circuit models (character data); see <a href="#">Table 11-10</a> . |
|----------------|--------------------------------------------------------------------------------------------------------------------------------------|

**Manual operation:** See "[Network](#)" on page 513

**CALCulate<Ch>:TRANSform:VNETworks:BALanced:DEEMbedding<LogPt>:**

**PARAmeters:L<Cmp>** <CircuitModel>, <Inductance>

**CALCulate<Ch>:TRANSform:VNETworks:BALanced:DEEMbedding<LogPt>:**

**PARAmeters:L<Cmp>?** <CircuitModel>

Specifies the inductance value L<Cmp> in the different circuit models for balanced port deembedding.

In the query form, the <Inductance> parameter must be omitted. The command returns the inductance value for the specified circuit model.

**Suffix:**

|         |                                                                                                               |
|---------|---------------------------------------------------------------------------------------------------------------|
| <Ch>    | Channel number                                                                                                |
| <LogPt> | Logical port number (balanced port)                                                                           |
| <Cmp>   | Number of inductance in circuit model. The total number of inductances depends on the selected circuit model. |

**Parameters:**

|              |                                                                                                                                                 |
|--------------|-------------------------------------------------------------------------------------------------------------------------------------------------|
| <Inductance> | Inductance L<Cmp> for the specified circuit model.<br>Range: -1H to 1 H.<br>Increment: 1 pH (1E-12 H)<br>*RST: 1 nH (1E-9 H)<br>Default unit: H |
|--------------|-------------------------------------------------------------------------------------------------------------------------------------------------|

**Parameters for setting and query:**

|                |                                                                                                                                                                     |
|----------------|---------------------------------------------------------------------------------------------------------------------------------------------------------------------|
| <CircuitModel> | STSL   SLST   CSSL   LSSC   LSSL   SLCS   SCLS   SLLS  <br>GSSL   LSSG   SLGS   SGLS<br>Possible circuit models (character data); see <a href="#">Table 11-10</a> . |
|----------------|---------------------------------------------------------------------------------------------------------------------------------------------------------------------|

**Example:**                   \***RST**; :**SOUR**:LPOR1 1,2; :**CALC**:TRAN:VNET:BAL:DEEM:PAR:L1? CSSL  
 Create a balanced port and query the default inductance L1 for the Serial Cs, shunt L circuit model. The response is 1E-009 (1 nH).  
**CALC**:TRAN:VNET:BAL:DEEM:PAR:L1 CSSL, 2.2E-9  
 Increase the inductance to 2.2 nH.

**Manual operation:** See "[Network](#)" on page 513

---

**CALCulate<Ch>:TRANSform:VNETworks:BALanced:DEEMbedding<LogPt>:PARAMeters:R<Cmp>** <CircuitModel>, <Resistance>  
**CALCulate<Ch>:TRANSform:VNETworks:BALanced:DEEMbedding<LogPt>:PARAMeters:R<Cmp>?** <CircuitModel>

Specifies the resistance value R<Cmp> in the different circuit models for balanced port deembedding.

In the query form, the <Resistance> parameter must be omitted. The command returns the resistance value for the specified circuit model.

**Suffix:**

<Ch>                           Channel number  
 <LogPt>                       Logical port number (balanced port)  
 <Cmp>                         Number of resistance in circuit model. The total number of resistances depends on the selected circuit model.

**Parameters:**

<Resistance>                 Resistance R<Cmp> for the specified circuit model.  
 Range:                       -10 MΩ to 10 MΩ.  
 Increment:                  1 mΩ (1E-3 Ω)  
 \***RST**:                       0 Ω for all resistances connected in series with an inductance. 10 MΩ for all resistances connected in parallel with a capacitance  
 Default unit: Ω

**Parameters for setting and query:**

<CircuitModel>             STSL | STSC | SLST | SCST | CSSL | LSSC | CSSC | LSSL | SLCS | SCLS | SCCS | SLLS | GSSL | LSSG | SLGS | SGLS  
 Possible circuit models (character data); see [Table 11-10](#).

**Example:**                   \***RST**; :**SOUR**:LPOR1 1,2; :**CALC**:TRAN:VNET:BAL:DEEM:PAR:R1? CSSL; R2? CSSL; R3? CSSL  
 Create a balanced port and query the default resistances for the Serial Cs, shunt L circuit model. The response is 10000000000;10000000000; 0.  
**CALC**:TRAN:VNET:BAL:DEEM:PAR:R3 CSSL, 2.2E+3  
 Increase the resistance R3 to 2.2 kΩ.

**Manual operation:** See "[Network](#)" on page 513



---

**CALCulate<Ch>:TRANSform:VNETworks:BALanced:DEEMbedding<LogPt>:  
TNDefinition <CircuitModel>**

Selects the circuit model for balanced port deembedding.

**Suffix:**

<Ch> Channel number  
<LogPt> Logical port number (balanced port)

**Parameters:**

<CircuitModel> FIMPort | STSL | STSC | SLST | SCST | CSSL | LSSC | CSSC |  
LSSL | SLCS | SCLS | SCCS | SLLS | STSG | SGST | GSSL |  
LSSG | GSSG | SLGS | SGLS | SGGS

Possible circuit models (character data); see [Table 11-10](#).

\*RST: CSSL

**Example:**

See [CALCulate<Ch>:TRANSform:VNETworks:BALanced:  
DEEMbedding<LogPt>\[:STATE\]](#)

**Manual operation:** See "[Network](#)" on page 513

---

**CALCulate<Ch>:TRANSform:VNETworks:BALanced:EMBedding<LogPt>[:STATE]  
<Boolean>**

Enables or disables the embedding function for balanced ports. It is allowed to change the circuit model and its parameters while embedding is enabled.

**Suffix:**

<Ch> Channel number  
<LogPt> Logical port number (balanced port)

**Parameters:**

<Boolean> ON | OFF - embedding active or inactive

\*RST: OFF

**Example:**

\*RST; SOUR:LPOR1 1,2; LPOR2 3,4

Define a balanced port configuration.

CALC:TRAN:VNET:BAL:EMB:TND CSSL

Select the Serial Cs, shunt L circuit model for embedding.

CALC:TRAN:VNET:BAL:EMB:PAR:R3 CSSL, 2.2E+3; :

CALC:TRAN:VNET:BAL:EMB ON

Increase the resistance R3 for the Serial Cs, shunt L circuit model to 2.2 kΩ and enable embedding.

**Manual operation:** See "[Active](#)" on page 496

---

**CALCulate<Ch>:TRANSform:VNETworks:BALanced:EMBedding<LogPt>:  
PARAmeters:C<Cmp> <CircuitModel>, <Capacitance>**  
**CALCulate<Ch>:TRANSform:VNETworks:BALanced:EMBedding<LogPt>:  
PARAmeters:C<Cmp>? <CircuitModel>**

Specifies the capacitance value C<Cmp> in the different circuit models for balanced port embedding.

In the query form, the <Capacitance> parameter must be omitted. The command returns the capacitance value for the specified circuit model.

**Suffix:**

|         |                                                                                                                 |
|---------|-----------------------------------------------------------------------------------------------------------------|
| <Ch>    | Channel number                                                                                                  |
| <LogPt> | Logical port number (balanced port)                                                                             |
| <Cmp>   | Number of capacitance in circuit model. The total number of capacitances depends on the selected circuit model. |

**Parameters:**

|               |                                                                                                                                                     |
|---------------|-----------------------------------------------------------------------------------------------------------------------------------------------------|
| <Capacitance> | Capacitance C<Cmp> for the specified circuit model.<br>Range: -1mF to 1 mF.<br>Increment: 1 fF (1E-15 F)<br>*RST: 1 pF (1E-12 F)<br>Default unit: F |
|---------------|-----------------------------------------------------------------------------------------------------------------------------------------------------|

**Parameters for setting and query:**

|                |                                                                                                                                                                                              |
|----------------|----------------------------------------------------------------------------------------------------------------------------------------------------------------------------------------------|
| <CircuitModel> | STSC   SCST   CSSL   LSSC   CSSC   SLCS   SCLS   SCCS   STSG   SGST   GSSL   LSSG   GSSG   SLGS   SGLS   SGGS<br>Possible circuit models (character data); see <a href="#">Table 11-10</a> . |
|----------------|----------------------------------------------------------------------------------------------------------------------------------------------------------------------------------------------|

**Example:**

```
*RST; :SOUR:LPOR1 1,2; :CALC:TRAN:VNET:BAL:EMB:
PAR:C2? CSSL
Create a balanced port and query the default capacitance C2 for
the Serial Cs, shunt L circuit model. The response is 1E-012 (1
pF).
CALC:TRAN:VNET:BAL:EMB:PAR:C2 CSSL, 2.2E-12
Increase the capacitance to 2.2 pF.
```

**Manual operation:** See "[Network](#)" on page 513

---

**CALCulate<Ch>:TRANSform:VNETworks:BALanced:EMBedding<LogPt>:  
PARAmeters:DATA<Port> <Interchange>, <arg1>**

Defines an embedding network for a balanced port based on the given S-Parameter traces.

Circuit models STSL | STSC | SLST | SCST require S-Parameter traces of two 2-port networks, to be assigned to the different ports; the FIMPort model requires S-Parameter traces of a single 4-port network but no additional port assignment.

## Use

- `CALCulate<Ch>:TRANSform:VNETworks:BALanced:EMBedding<LogPt>:TNDefinition` to select the adequate circuit model **before** executing this command.
- `MMEMory:LOAD:VNETworks<Ch>:BALanced:EMBedding<LogPt>` to load circuit data from a Touchstone file located at the R&S ZNL/ZNLE's file system.

**Suffix:**

|         |                                                                                                                        |
|---------|------------------------------------------------------------------------------------------------------------------------|
| <Ch>    | Channel number                                                                                                         |
| <LogPt> | Logical port number                                                                                                    |
| <Port>  | Port assignment for two 2-port networks:<br>1 - Port 1<br>2 - Port 2<br>This parameter is ignored for 4-port networks. |

**Setting parameters:**

|               |                                                                                                                                                                                                                                                                                                                                                                                                                                                                                                                                                                                                                               |
|---------------|-------------------------------------------------------------------------------------------------------------------------------------------------------------------------------------------------------------------------------------------------------------------------------------------------------------------------------------------------------------------------------------------------------------------------------------------------------------------------------------------------------------------------------------------------------------------------------------------------------------------------------|
| <Interchange> | FPORts   IPORts   SGATes   SINcreasing<br><b>FPORts (or omitted)</b><br>Standard port sequence (odd port numbers towards VNA, even port numbers towards DUT)<br><b>IPORts</b><br>– Two-port networks: inverted port sequence (network port 2 towards VNA, network port 1 towards DUT)<br>– Four-port networks: increasing port sequence (low port numbers towards VNA, high port numbers towards DUT)<br><b>SGATes</b><br>Swapped gates (even port numbers towards VNA, odd port numbers towards DUT)<br><b>SINcreasing</b><br>Swapped increasing port sequence (high port numbers towards VNA, low port numbers towards DUT) |
| <arg1>        | <block_data><br>Content of a Touchstone file (*.s2p or *.s4p) in IEEE488.2 <a href="#">Block Data Format</a> .                                                                                                                                                                                                                                                                                                                                                                                                                                                                                                                |

**Usage:** Setting only

---

**CALCulate<Ch>:TRANSform:VNETworks:BALanced:EMBedding<LogPt>:PARAMeters:G<Cmp>** <CircuitModel>, <Conductance>  
**CALCulate<Ch>:TRANSform:VNETworks:BALanced:EMBedding<LogPt>:PARAMeters:G<Cmp>?** <CircuitModel>

Specifies the conductance value G<Cmp> in the different circuit models for balanced port embedding.

In the query form, the <Conductance> parameter must be omitted. The command returns the capacitance value for the specified circuit model.

**Suffix:**

|         |                                                                                                                 |
|---------|-----------------------------------------------------------------------------------------------------------------|
| <Ch>    | Channel number                                                                                                  |
| <LogPt> | Logical port number (balanced port)                                                                             |
| <Cmp>   | Number of conductance in circuit model. The total number of conductances depends on the selected circuit model. |

**Parameters:**

|               |                                                                                                                                                                    |
|---------------|--------------------------------------------------------------------------------------------------------------------------------------------------------------------|
| <Conductance> | Conductance G<Cmp> for the specified circuit model.<br>Range: -1kS to 1 kS.<br>Increment: 1 pS (1E-12 S)<br>*RST: 0 S<br>Default unit: Siemens (SI unit symbol: S) |
|---------------|--------------------------------------------------------------------------------------------------------------------------------------------------------------------|

**Parameters for setting and query:**

|                |                                                                                                                                      |
|----------------|--------------------------------------------------------------------------------------------------------------------------------------|
| <CircuitModel> | STSG   SGST   GSSL   LSSG   GSSG   SLGS   SGLS   SGGS<br>Possible circuit models (character data); see <a href="#">Table 11-10</a> . |
|----------------|--------------------------------------------------------------------------------------------------------------------------------------|

**Manual operation:** See "[Network](#)" on page 513

**CALCulate<Ch>:TRANSform:VNETworks:BALanced:EMBedding<LogPt>:**

**PARAmeters:L<Cmp>** <CircuitModel>, <Inductance>

**CALCulate<Ch>:TRANSform:VNETworks:BALanced:EMBedding<LogPt>:**

**PARAmeters:L<Cmp>?** <CircuitModel>

Specifies the inductance values L1, L2, L3 in the different circuit models for balanced port embedding.

In the query form, the <Inductance> parameter must be omitted. The command returns the inductance value for the specified circuit model.

**Suffix:**

|         |                                                                                                               |
|---------|---------------------------------------------------------------------------------------------------------------|
| <Ch>    | Channel number                                                                                                |
| <LogPt> | Logical port number (balanced port)                                                                           |
| <Cmp>   | Number of inductance in circuit model. The total number of inductances depends on the selected circuit model. |

**Parameters:**

|              |                                                                                                                                                 |
|--------------|-------------------------------------------------------------------------------------------------------------------------------------------------|
| <Inductance> | Inductance L<Cmp> for the specified circuit model.<br>Range: -1H to 1 H.<br>Increment: 1 pH (1E-12 H)<br>*RST: 1 nH (1E-9 H)<br>Default unit: H |
|--------------|-------------------------------------------------------------------------------------------------------------------------------------------------|

**Parameters for setting and query:**

|                |                                                                                                                                                                     |
|----------------|---------------------------------------------------------------------------------------------------------------------------------------------------------------------|
| <CircuitModel> | STSL   SLST   CSSL   LSSC   LSSL   SLCS   SCLS   SLLS  <br>GSSL   LSSG   SLGS   SGLS<br>Possible circuit models (character data); see <a href="#">Table 11-10</a> . |
|----------------|---------------------------------------------------------------------------------------------------------------------------------------------------------------------|

**Example:** `*RST; :SOUR:LPOR1 1,2; :CALC:TRAN:VNET:BAL:EMB:PAR:L1? CSSL`  
 Create a balanced port and query the default inductance L1 for the Serial Cs, shunt L circuit model. The response is 1E-009 (1 nH).  
`CALC:TRAN:VNET:BAL:EMB:PAR:L1 CSSL, 2.2E-9`  
 Increase the inductance to 2.2 nH.

**Manual operation:** See "[Network](#)" on page 513

---

**CALCulate<Ch>:TRANSform:VNETworks:BALanced:EMBedding<LogPt>:  
 PARameters:R<Cmp> <CircuitModel>, <Resistance>**  
**CALCulate<Ch>:TRANSform:VNETworks:BALanced:EMBedding<LogPt>:  
 PARameters:R<Cmp>? <CircuitModel>**

Specifies the resistance values R1, R2, R3 in the different circuit models for balanced port embedding.

In the query form, the <Resistance> parameter must be omitted. The command returns the resistance value for the specified circuit model.

**Suffix:**

<Ch> Channel number  
 <LogPt> Logical port number (balanced port)  
 <Cmp> Number of resistance in circuit model. The total number of resistances depends on the selected circuit model.

**Parameters:**

<Resistance> Resistance R<Cmp> for the specified circuit model.  
 Range: -10 MΩ to 10 MΩ.  
 Increment: 1 mΩ (1E-3 Ω)  
 \*RST: 0 Ω for all resistances connected in series with an inductance. 10 MΩ for all resistances connected in parallel with a capacitance  
 Default unit: Ω

**Parameters for setting and query:**

<CircuitModel> STSL | STSC | SLST | SCST | CSSL | LSSC | CSSC | LSSL | SLCS | SCLS | SCCS | SLLS | GSSL | LSSG | SLGS | SGLS  
 Possible circuit models (character data); see [Table 11-10](#).

**Example:** `*RST; :SOUR:LPOR1 1,2; :CALC:TRAN:VNET:BAL:EMB:PAR:R1? CSSL; R2? CSSL; R3? CSSL`  
 Create a balanced port and query the default resistances for the Serial Cs, shunt L circuit model. The response is 10000000000;10000000000; 0.  
`CALC:TRAN:VNET:BAL:EMB:PAR:R3 CSSL, 2.2E+3`  
 Increase the resistance R3 to 2.2 kΩ.

**Manual operation:** See "[Network](#)" on page 513

---

**CALCulate<Ch>:TRANSform:VNETworks:BALanced:EMBedding<LogPt>:  
TNDefinition <CircuitModel>**

Selects the circuit model for balanced port embedding.

**Suffix:**

<Ch> Channel number  
<LogPt> Logical port number (balanced port)

**Parameters:**

<CircuitModel> FIMPort | STSL | STSC | SLST | SCST | CSSL | LSSC | CSSC |  
LSSL | SLCS | SCLS | SCCS | SLLS | STSG | SGST | GSSL |  
LSSG | GSSG | SLGS | SGLS | SGGS

Possible circuit models (character data); see [Table 11-10](#).

\*RST: CSSL

**Example:**

See [CALCulate<Ch>:TRANSform:VNETworks:BALanced:  
EMBedding<LogPt>\[:STATE\]](#)

**Manual operation:** See "[Network](#)" on page 513

---

**CALCulate<Ch>:TRANSform:VNETworks:DIFFerential:EMBedding<LogPt>[:  
STATE] <Boolean>**

Enables or disables differential match embedding for balanced port <LogPt>.

**Suffix:**

<Ch> Channel number  
<LogPt> Logical port number (balanced port)

**Parameters:**

<Boolean> ON | OFF - embedding active or inactive

\*RST: OFF

**Manual operation:** See "[Active](#)" on page 499

---

**CALCulate<Ch>:TRANSform:VNETworks:DIFFerential:EMBedding<LogPt>:  
PARAmeters:C<Cmp> <CircuitModel>[, <Capacitance>]**

Specifies the capacitance value C in the "Shunt L, Shunt C" lumped element model for differential match embedding.

In the query form, the <Capacitance> parameter must be omitted.

**Suffix:**

<Ch> Channel number  
<LogPt> Logical port number (balanced port)  
<Cmp> Must be omitted or set to 1.

**Parameters:**

|                |                                                                                              |
|----------------|----------------------------------------------------------------------------------------------|
| <CircuitModel> | SHLC<br>Currently only the "Shunt L, Shunt C" lumped element model is supported              |
| <Capacitance>  | Range: -1mF to 1 mF.<br>Increment: 1 fF (1E-15 F)<br>*RST: 1 pF (1E-12 F)<br>Default unit: F |

**Manual operation:** See "[Network](#)" on page 518

**CALCulate<Ch>:TRANSform:VNETworks:DIFFerential:EMBedding<LogPt>:  
PARAmeters:DATA <Interchange>, <SParamTrcs>**

Defines a [Differential Match Embedding](#) network for a balanced port based on the given S-Parameter traces.

Use [MMEMory:LOAD:VNETworks<Ch>:DIFFerential:EMBedding<LogPt>](#) to load circuit data from a Touchstone file located at the R&S ZNL/ZNLE's file system instead.

**Suffix:**

|         |                                        |
|---------|----------------------------------------|
| <Ch>    | Channel number                         |
| <LogPt> | Logical port number of a balanced port |

**Setting parameters:**

|               |                                                                                                                                                                                                                                                        |
|---------------|--------------------------------------------------------------------------------------------------------------------------------------------------------------------------------------------------------------------------------------------------------|
| <Interchange> | FPORts   IPORts   SGATes<br><b>FPORts (or omitted)</b><br>Standard port sequence (network port 1 towards VNA, network port 2 towards DUT)<br><b>IPORts   SGATes</b><br>Inverted port sequence (network port 2 towards VNA, network port 1 towards DUT) |
| <SParamTrcs>  | <block_data><br>Content of a two-port Touchstone file (*.s2p) in IEEE488.2 <a href="#">Block Data Format</a> .                                                                                                                                         |

**Usage:** Setting only

**CALCulate<Ch>:TRANSform:VNETworks:DIFFerential:EMBedding<LogPt>:  
PARAmeters:G<Cmp> <CircuitModel>[, <Conductance>]**

Specifies the conductance value G in the "Shunt L, Shunt C" lumped element model for differential match embedding.

In the query form, the <Conductance> parameter must be omitted.

**Suffix:**

|      |                |
|------|----------------|
| <Ch> | Channel number |
|------|----------------|

<LogPt> Logical port number (balanced port)

<Cmp> Must be omitted or set to 1.

**Parameters:**

<CircuitModel> SHLC

Currently only the "Shunt L, Shunt C" lumped element model is supported

<Conductance> Range: -10 MS to 10 MS.  
Increment: 1  $\mu$ S (1E-6 F)  
\*RST: 0 S  
Default unit: S(iemens)

**Manual operation:** See "[Network](#)" on page 518

**CALCulate<Ch>:TRANSform:VNETworks:DIFFerential:EMBedding<LogPt>:  
PARAmeters:L<Cmp> <CircuitModel>[, <Inductance>]**

Specifies the inductance value L in the "Shunt L, Shunt C" lumped element model for differential match embedding.

In the query form, the <Inductance> parameter must be omitted.

**Suffix:**

<Ch> Channel number

<LogPt> Logical port number (balanced port)

<Cmp> Must be omitted or set to 1

**Parameters:**

<CircuitModel> SHLC

Currently only the "Shunt L, Shunt C" lumped element model is supported

<Inductance> Range: -1 H to 1 H  
Increment: 1 pH (1E-12 H)  
\*RST: 1 nH (1E-9 H)  
Default unit: H

**Manual operation:** See "[Network](#)" on page 518

**CALCulate<Ch>:TRANSform:VNETworks:DIFFerential:EMBedding<LogPt>:  
PARAmeters:R<Cmp> <CircuitModel>[, <Resistance>]**

Specifies the resistance value R in the "Shunt L, Shunt C" lumped element model for differential match embedding.

In the query form, the <Resistance> parameter must be omitted.

**Suffix:**

<Ch> Channel number

<LogPt> Logical port number (balanced port)



<Cmp> Must be omitted or set to 1.

**Parameters:**

<CircuitModel> SHLC  
Currently only the "Shunt L, Shunt C" lumped element model is supported

<Resistance> Range: -10 MΩ to 10 MΩ.  
Increment: 1 mΩ (1E-3 Ω)  
\*RST: 0 Ω  
Default unit: Ohm

**Manual operation:** See "[Network](#)" on page 518

**CALCulate<Ch>:TRANSform:VNETworks:DIFFerential:EMBEDding<LogPt>:  
TNDefinition <CircuitModel>**

Selects the circuit model for differential match embedding.

**Suffix:**

<Ch> Channel number  
<LogPt> Logical port number (balanced port)

**Parameters:**

<CircuitModel> FIMPort | SHLC  
Possible circuit models (character data), see [Circuit models for differential match embedding](#)

**Manual operation:** See "[Network](#)" on page 518

**CALCulate<Ch>:TRANSform:VNETworks:GLOop:DEEMbedding[:STATE]  
<Boolean>**

Enables or disables the deembedding function for ground loops. It is allowed to change the circuit model and its parameters while deembedding is enabled.

**Suffix:**

<Ch> Channel number.

**Parameters:**

<Boolean> ON - Deembedding active  
OFF - Deembedding inactive  
\*RST: OFF

**Example:**

```
CALC:TRAN:VNET:GLO:DEEM:TND SL
Select the Shunt L circuit model for deembedding.
CALC:TRAN:VNET:GLO:DEEM:PAR:R SL, 2.2E+3; :
CALC:TRAN:VNET:GLO:DEEM ON
Increase the resistance for the Shunt L circuit model to 2.2 kΩ
and enable deembedding.
```

**Manual operation:** See "[Active](#)" on page 497

---

**CALCulate<Ch>:TRANSform:VNETworks:GLOop:DEEMbedding:PARAmeters:C**  
<CircuitModel>, <Capacitance>

**CALCulate<Ch>:TRANSform:VNETworks:GLOop:DEEMbedding:PARAmeters:C?**  
<CircuitModel>

Specifies the capacitance value C in the different circuit models for ground loop embedding.

**Suffix:**

<Ch> Channel number

**Parameters:**

<Capacitance> Capacitance C for ground loop deembedding.  
Range: -1mF to 1 mF.  
Increment: 1 fF (1E-15 F)  
\*RST: 1 pF (1E-12 F)  
Default unit: F

**Parameters for setting and query:**

<CircuitModel> SC | SG  
Possible circuit models (character data); see [Table 11-12](#).

**Example:**

```
*RST; :CALC:TRAN:VNET:GLO:DEEM:PAR:C? SC
Query the default capacitance for ground loop deembedding.
The response is 1E-012 (1 pF).
CALC:TRAN:VNET:GLO:DEEM:PAR:C SC, 2.2E-12
Increase the capacitance to 2.2 pF.
```

**Manual operation:** See "[Network](#)" on page 516

---

**CALCulate<Ch>:TRANSform:VNETworks:GLOop:DEEMbedding:PARAmeters:G**  
<CircuitModel>, <Conductance>

**CALCulate<Ch>:TRANSform:VNETworks:GLOop:DEEMbedding:PARAmeters:G?**  
<CircuitModel>

Specifies the conductance value G in the different circuit models for ground loop embedding.

**Suffix:**

<Ch> Channel number.

**Parameters:**

<Conductance> Conductance G for the specified circuit model.  
Range: -1kS to 1 kS.  
Increment: 1 nS (1E-9 S)  
\*RST: 0 S  
Default unit: Siemens (SI unit symbol: S)

**Parameters for setting and query:**

<CircuitModel> SG  
Possible circuit models (character data); see [Table 11-12](#).

**Manual operation:** See "[Network](#)" on page 516

---

**CALCulate<Ch>:TRANSform:VNETworks:GLOop:DEEMbedding:PARAmeters:L**  
<CircuitModel>, <Inductance>

**CALCulate<Ch>:TRANSform:VNETworks:GLOop:DEEMbedding:PARAmeters:L?**  
<CircuitModel>

Specifies the inductance value in the different circuit models for ground loop deembedding.

**Suffix:**

<Ch> Channel number.

**Parameters:**

<Inductance> Inductance L for ground loop deembedding.  
Range: -1 H to 1 H.  
Increment: 1 pH (1E-12 H)  
\*RST: 1 nH (1E-9 H)  
Default unit: H

**Parameters for setting and query:**

<CircuitModel> SL  
Possible circuit models (character data); see [Table 11-12](#).

**Example:**

```
*RST; :CALC:TRAN:VNET:GLO:DEEM:PAR:L? SL
Query the default inductance for ground loop deembedding. The
response is 1E-009 (1 nH).
CALC:TRAN:VNET:GLO:DEEM:PAR:L SL, 2.2E-9
Increase the inductance to 2.2 nH.
```

**Manual operation:** See "[Network](#)" on page 516

---

**CALCulate<Ch>:TRANSform:VNETworks:GLOop:DEEMbedding:PARAmeters:R**  
<CircuitModel>, <Resistance>

**CALCulate<Ch>:TRANSform:VNETworks:GLOop:DEEMbedding:PARAmeters:R?**  
<CircuitModel>

Specifies the resistance value R in the different circuit models for ground loop deembedding.

**Suffix:**

<Ch> Channel number.

**Parameters:**

<Resistance> Resistance R for the specified circuit model.  
Range: -10 MΩ to 10 MΩ  
Increment: 1 mΩ  
\*RST: 0 Ω if the resistance is connected in series with an inductance. 10 MΩ if the resistance is connected in parallel with a capacitance)  
Default unit: Ω

**Parameters for setting and query:****<CircuitModel>** SL | SCPossible circuit models (character data); see [Table 11-12](#).**Example:**

```
*RST; :CALC:TRAN:VNET:GLO:DEEM:PAR:R? SC; R? SL
```

Query the default resistances for ground loop deembedding. The response is 10000000; 0.

```
CALC:TRAN:VNET:GLO:DEEM:PAR:R SC, 2.2E+3
```

Increase the resistance for the Shunt C model to 2.2 kΩ.

**Manual operation:** See "[Network](#)" on page 516**CALCulate<Ch>:TRANSform:VNETworks:GLOop:DEEMbedding:TNDefinition****<CircuitModel>**

Selects the circuit model for ground loop deembedding.

**Suffix:****<Ch>** Channel number.**Parameters:****<CircuitModel>** FIMPort | SL | SC | SGPossible circuit models (character data); see [Circuit models for ground loop de-/embedding](#).**Example:**

```
See CALCulate<Ch>:TRANSform:VNETworks:GLOop:
DEEMbedding[:STATe] on page 721
```

**Manual operation:** See "[Network](#)" on page 516**CALCulate<Ch>:TRANSform:VNETworks:GLOop:EMBedding[:STATe] <Boolean>**

Enables or disables the embedding function for ground loops. It is allowed to change the circuit model and its parameters while embedding is enabled.

**Suffix:****<Ch>** Channel number.**Parameters:**

**<Boolean>** ON - Embedding active  
 OFF - Embedding inactive

```
*RST: OFF
```

**Example:**

```
CALC:TRAN:VNET:GLO:EMB:TND SL
```

Select the Shunt L circuit model for embedding.

```
CALC:TRAN:VNET:GLO:EMB:PAR:R SL, 2.2E+3; :CALC:
TRAN:VNET:GLO:EMB ON
```

Increase the resistance for the Shunt L circuit model to 2.2 kΩ and enable embedding.

**Manual operation:** See "[Active](#)" on page 497

---

**CALCulate<Ch>:TRANSform:VNETworks:GLOop:EMBedding:PARameters:C**  
<CircuitModel>, <Capacitance>

**CALCulate<Ch>:TRANSform:VNETworks:GLOop:EMBedding:PARameters:C?**  
<CircuitModel>

Specifies the capacitance value C in the different circuit models for ground loop embedding.

**Suffix:**

<Ch> Channel number.

**Parameters:**

<Capacitance> Capacitance C for ground loop embedding.  
Range: -1mF to 1 mF.  
Increment: 1 fF (1E-15 F)  
\*RST: 1 pF (1E-12 F)  
Default unit: F

**Parameters for setting and query:**

<CircuitModel> SC | SG  
Possible circuit models (character data); see [Table 11-12](#).

**Example:**

```
*RST; :CALC:TRAN:VNET:GLO:EMB:PAR:C? SC
Query the default capacitance for ground loop embedding. The
response is 1E-012 (1 pF).
CALC:TRAN:VNET:GLO:EMB:PAR:C SC, 2.2E-12
Increase the capacitance to 2.2 pF.
```

**Manual operation:** See "[Network](#)" on page 516

---

**CALCulate<Ch>:TRANSform:VNETworks:GLOop:EMBedding:PARameters:G**  
<CircuitModel>, <Conductance>

**CALCulate<Ch>:TRANSform:VNETworks:GLOop:EMBedding:PARameters:G?**  
<CircuitModel>

Specifies the conductance value G in the different circuit models for ground loop embedding.

**Suffix:**

<Ch> Channel number.

**Parameters:**

<Conductance> Conductance G for the specified circuit model.  
Range: -1kS to 1 kS.  
Increment: 1 pS (1E-12 S)  
\*RST: 0 S  
Default unit: Siemens (SI unit symbol: S)

**Parameters for setting and query:**

<CircuitModel> SG  
Possible circuit models (character data); see [Table 11-12](#).

**Manual operation:** See "[Network](#)" on page 516

---

**CALCulate<Ch>:TRANSform:VNETworks:GLOop:EMBedding:PARameters:L**  
<CircuitModel>, <Inductance>

**CALCulate<Ch>:TRANSform:VNETworks:GLOop:EMBedding:PARameters:L?**  
<CircuitModel>

Specifies the inductance value in the different circuit models for ground loop embedding.

**Suffix:**

<Ch> Channel number.

**Parameters:**

<Inductance> Inductance L for ground loop embedding.  
Range: -1H to 1 H.  
Increment: 1 pH (1E-12 H)  
\*RST: 1 nH (1E-9 H)  
Default unit: H

**Parameters for setting and query:**

<CircuitModel> SL  
Possible circuit models (character data); see [Table 11-12](#).

**Example:**

```
*RST; :CALC:TRAN:VNET:GLO:EMB:PAR:L? SL
```

Query the default inductance for ground loop embedding. The response is 1E-009 (1 nH).

```
CALC:TRAN:VNET:GLO:EMB:PAR:L SL, 2.2E-9
```

Increase the inductance to 2.2 nH.

**Manual operation:** See "[Network](#)" on page 516

---

**CALCulate<Ch>:TRANSform:VNETworks:GLOop:EMBedding:PARameters:R**  
<CircuitModel>, <Resistance>

**CALCulate<Ch>:TRANSform:VNETworks:GLOop:EMBedding:PARameters:R?**  
<CircuitModel>

Specifies the resistance value R in the different circuit models for ground loop embedding.

**Suffix:**

<Ch> Channel number.

**Parameters:**

<Resistance> Resistance R for the specified circuit model.  
Range: -10 MΩ to 10 MΩ  
Increment: 1 mΩ  
\*RST: 0 Ω if the resistance is connected in series with an inductance. 10 MΩ if the resistance is connected in parallel with a capacitance)  
Default unit: Ω

**Parameters for setting and query:****<CircuitModel>** SL | SCPossible circuit models (character data); see [Table 11-12](#).**Example:**

```
*RST; :CALC:TRAN:VNET:GLO:EMB:PAR:R? SC; R? SL
Query the default resistances for ground loop embedding. The
response is 10000000; 0.
CALC:TRAN:VNET:GLO:EMB:PAR:R SC, 2.2E+3
Increase the resistance for the Shunt C model to 2.2 kΩ.
```

**Manual operation:** See ["Network"](#) on page 516**CALCulate<Ch>:TRANSform:VNETworks:GLOop:EMBedding:TNDefinition**  
**<CircuitModel>**

Selects the circuit model for ground loop embedding.

**Suffix:****<Ch>** Channel number.**Parameters:****<CircuitModel>** FIMPort | SL | SC | SGPossible circuit models (character data); see [Circuit models for ground loop de-/embedding](#).**\*RST:** FIMPort**Example:**See [CALCulate<Ch>:TRANSform:VNETworks:GLOop:EMBedding\[:STATE\]](#) on page 724**Manual operation:** See ["Network"](#) on page 516**CALCulate<Ch>:TRANSform:VNETworks:FSIMulator[:STATE] <Enable>**

De/activates the "Fixture Simulator" switch that allows to disable and (re-)enable the configured deembedding, embedding, balanced ports, and port impedance settings for the selected channel.

**Suffix:****<Ch>** Channel number**Parameters:****<Enable>****Manual operation:** See ["Fixture Simulator"](#) on page 485**CALCulate<Ch>:TRANSform:VNETworks:PPAir:DEEMbedding:DELeTe**

Deletes all port sets (including port pairs) previously defined for deembedding.

**Suffix:****<Ch>** Channel number

- Example:** See [CALCulate<Ch>:TRANSform:VNETworks:PPAir:DEEMbedding<ListId>\[:STATE\]](#)
- Usage:** Event
- Manual operation:** See ["Add / Delete"](#) on page 494

**CALCulate<Ch>:TRANSform:VNETworks:PPAir:DEEMbedding<ListId>[:STATE]**  
 <arg0>

Enables or disables the deembedding function for port set (or port pair) <ListId>. It is allowed to change the deembedding network while embedding is enabled.

**Suffix:**

- <Ch> Channel number
- <ListId> Index of the affected port set

**Parameters:**

- <arg0> **OFF** (0): Deembedding inactive  
**ON** (1): Deembedding active  
 \*RST: OFF (0)

- Example:** \*RST; CALC:TRAN:VNET:PPA:DEEM:DEF 1,2,3,4  
 Define a port pair configuration with port pairs (1,2) and (3,4).  
 CALC:TRAN:VNET:PPA:DEEM1:TND CSSL  
 Select the Serial Cs, shunt L circuit model for the first port pair.  
 CALC:TRAN:VNET:PPA:DEEM1:PAR:  
 R3 CSSL, 2.2E+3; CALC:TRAN:VNET:PPA:DEEM1 ON  
 Increase the resistance R3 for the Serial Cs, shunt L circuit  
 model to 2.2 kΩ and enable deembedding.  
 CALC:TRAN:VNET:PPA:DEEM:DEL  
 Delete the port pair configuration.

- Manual operation:** See ["Active"](#) on page 495

**CALCulate<Ch>:TRANSform:VNETworks:PPAir:DEEMbedding<ListId>:DEFine**  
 <PP\_First>,<PP\_Second>,<PP\_First>,...

Creates one or more port pairs for port set deembedding. The command can be used repeatedly to extend or (partially) overwrite the list of port sets for deembedding.

See [CALCulate<Ch>:TRANSform:VNETworks:PSET:DEEMbedding<ListId>:DEFine](#) on page 737 for general port set definition.

**Suffix:**

- <Ch> Channel number



<ListId> Index of the defined port set within the channel's overall list of port sets for deembedding.  
Port sets for deembedding must be numbered consecutively, i.e. port set <ListId> can only be created if port set <ListId>-1 already exists. If several port pairs are specified, <ListId> is the number of the first port pair to be created.

**Parameters:**

<PP\_First>,  
<PP\_Second>,  
<PP\_First>, ... Sequence of port pairs, each one consisting of two different ports.

**Example:**

See `CALCulate<Ch>:TRANSform:VNETworks:PPAir:DEEMbedding<ListId>[:STATE]`

**Usage:**

Setting only

**Manual operation:** See "Add / Delete" on page 494

**CALCulate<Ch>:TRANSform:VNETworks:PPAir:DEEMbedding<ListId>:**

**PARAMeters:C<1|2|3>** <CircuitModel>, <Capacitance>

**CALCulate<Ch>:TRANSform:VNETworks:PPAir:DEEMbedding<ListId>:**

**PARAMeters:C<1|2|3>?** <CircuitModel>

Specifies the capacitance value C<i> in the different lumped circuit models for port pair deembedding.

In the query form, the <Capacitance> parameter must be omitted. The command returns the capacitance value for the specified circuit model.

**Suffix:**

<Ch> Channel number

<ListId> Index of the affected port pair (see `CALCulate<Ch>:TRANSform:VNETworks:PPAir:DEEMbedding<ListId>:DEFine`)

<1|2|3> Index i of the capacitance C<i> in the related lumped circuit model. If unspecified the numeric suffix is set to 1.

**Parameters:**

<Capacitance> Capacitance Ci  
Range: -1 mF to 1 mF  
Increment: 1 fF (1E-15 F)  
\*RST: 1 pF (1E-12 F)  
Default unit: F

**Parameters for setting and query:**

<CircuitModel> STSC | SCST | CSSL | LSSC | CSSC | SLCS | SCLS | SCCS | STSG | SGST | GSSL | LSSG | GSSG | SLGS | SGLS | SGGS  
Circuit model whose capacitance C<i> shall be set, see [Table 11-10](#)

**Example:** See `CALCulate<Ch>:TRANSform:VNETworks:PPAir:DEEMbedding<ListId>[:STATE]`

**Manual operation:** See "Network" on page 511

**CALCulate<Ch>:TRANSform:VNETworks:PPAir:DEEMbedding<ListId>:  
PARAMeters:G<1|2|3> <CircuitModel>, <Conductance>**  
**CALCulate<Ch>:TRANSform:VNETworks:PPAir:DEEMbedding<ListId>:  
PARAMeters:G<1|2|3>? <CircuitModel>**

Specifies the conductance value G<i> in the different lumped circuit models for port pair deembedding.

In the query form, the <Conductance> parameter must be omitted. The command returns the conductance value for the specified circuit model.

**Suffix:**

<Ch> Channel number  
 <ListId> Index of the affected port pair (see `CALCulate<Ch>:TRANSform:VNETworks:PPAir:DEEMbedding<ListId>:DEFine`)  
 <1|2|3> Index i of the conductance G<i> in the related lumped circuit model. If unspecified the numeric suffix is set to 1.

**Parameters:**

<Conductance> Conductance G<i> for the specified circuit model.  
 Range: -1kS to 1 kS.  
 Increment: 1 nS (1E-9 S)  
 \*RST: 0 S  
 Default unit: Siemens (SI unit symbol: S)

**Parameters for setting and query:**

<CircuitModel> STSG | SGST | GSSL | LSSG | GSSG | SLGS | SGLS | SGGS  
 Circuit model whose conductance G<i> shall be set, see [Table 11-10](#)

**Manual operation:** See "Network" on page 511

**CALCulate<Ch>:TRANSform:VNETworks:PPAir:DEEMbedding<ListId>:  
PARAMeters:L<1|2|3> <CircuitModel>, <Inductance>**  
**CALCulate<Ch>:TRANSform:VNETworks:PPAir:DEEMbedding<ListId>:  
PARAMeters:L<1|2|3>? <CircuitModel>**

Specifies the inductance value L<i> in the different lumped circuit models for port pair deembedding.

In the query form, the <Inductance> parameter must be omitted. The command returns the inductance value for the specified circuit model.

**Suffix:**

<Ch> Channel number

<ListId> Index of the affected port pair (see [CALCulate<Ch>:TRANSform:VNETworks:PPAir:DEEMbedding<ListId>:DEFine](#))

<1|2|3> Index i of the inductance L<i> in the related lumped circuit model. If unspecified the numeric suffix is set to 1.

**Parameters:**

<Inductance> Inductance L<i>  
 Range: -1 H to 1 H.  
 Increment: 1 pH (1E-12 H)  
 \*RST: 1 nH (1E-9 H)  
 Default unit: H

**Parameters for setting and query:**

<CircuitModel> STSL | SLST | CSSL | LSSC | LSSL | SLCS | SCLS | SLLS | GSSL | LSSG | SLGS | SGLS  
 Circuit model whose inductance L<i> shall be set, see [Table 11-10](#)

**Example:** See [CALCulate<Ch>:TRANSform:VNETworks:PPAir:DEEMbedding<ListId>\[:STATE\]](#)

**Manual operation:** See "Network" on page 511

**CALCulate<Ch>:TRANSform:VNETworks:PPAir:DEEMbedding<ListId>:PARAMeters:R<1|2|3> <CircuitModel>[, <Resistance>]**

Specifies the resistance value R<i> in the different lumped circuit models for port pair deembedding.

In the query form, the <Resistance> parameter must be omitted. The command returns the resistance value for the specified circuit model.

**Suffix:**

<Ch> Channel number  
 <ListId> Index of the affected port pair (see [CALCulate<Ch>:TRANSform:VNETworks:PPAir:DEEMbedding<ListId>:DEFine](#))

<1|2|3> Index i of the resistance R<i> in the related lumped circuit model. If unspecified the numeric suffix is set to 1.

**Parameters:**

<CircuitModel> STSL | STSC | SLST | SCST | CSSL | LSSC | CSSC | LSSL | SLCS | SCLS | SCCS | SLLS | GSSL | LSSG | SLGS | SGLS  
 Circuit model whose resistance R<i> shall be set, see [Table 11-10](#)

**<Resistance>** Resistance R<i> for the specified circuit model.  
 Range: -10 MΩ to 10 MΩ  
 Increment: 1 mΩ  
 \*RST: 0 Ω if the resistance is connected in series with an inductance. 10 MΩ if the resistance is connected in parallel with a capacitance)  
 Default unit: Ohm

**Example:** See `CALCulate<Ch>:TRANSform:VNETworks:PPAir:DEEMbedding<ListId>[:STATE]`

**Manual operation:** See "Network" on page 511

### **CALCulate<Ch>:TRANSform:VNETworks:PPAir:DEEMbedding<ListId>:TNDefinition <arg0>**

Selects the circuit model for port pair deembedding.

**Suffix:**

**<Ch>** Channel number

**<ListId>** Index of the affected port pair (see `CALCulate<Ch>:TRANSform:VNETworks:PPAir:DEEMbedding<ListId>:DEFine`)

**Parameters:**

**<arg0>** FIMPort | STSL | STSC | SLST | SCST | CSSL | LSSC | CSSC | LSSL | SLCS | SCLS | SCCS | SLLS | STSG | SGST | GSSL | LSSG | GSSG | SLGS | SGLS | SGGS

Circuit model to be used for the addressed port pair, see [Table 11-10](#)

**Example:** See `CALCulate<Ch>:TRANSform:VNETworks:PPAir:DEEMbedding<ListId>[:STATE]`

**Manual operation:** See "Network" on page 511

### **CALCulate<Ch>:TRANSform:VNETworks:PPAir:EMBedding<ListId>[:STATE] <Boolean>**

Enables or disables the embedding function for **port set** <ListId>. It is allowed to change the embedding network while embedding is enabled.

**Suffix:**

**<Ch>** Channel number

**<ListId>** Index of the affected **port set** (see `CALCulate<Ch>:TRANSform:VNETworks:PPAir:EMBedding<ListId>:DEFine`)

**Parameters:**

<Boolean>           **OFF** (0): Embedding inactive  
                           **ON** (1): Embedding active  
 \*RST:                **OFF** (0)

**Example:**

```
*RST; CALC:TRAN:VNET:PPA:EMB:DEF 1,2,3,4
Define a port pair configuration with port pairs (1,2) and (3,4).
CALC:TRAN:VNET:PPA:EMB1:TND CSSL
Select the Serial Cs, shunt L circuit model for the first port pair.
CALC:TRAN:VNET:PPA:EMB1:PAR:
R3 CSSL, 2.2E+3; CALC:TRAN:VNET:PPA:EMB1 ON
Increase the resistance R3 for the Serial Cs, shunt L circuit
model to 2.2 kΩ and enable deembedding.
CALC:TRAN:VNET:PPA:EMB:DEL
Delete the port pair configuration.
```

**Manual operation:** See ["Active"](#) on page 495

**CALCulate<Ch>:TRANSform:VNETworks:PPAir:EMBedding<ListId>:DEFine**  
 <PP\_First>,<PP\_Second>,<PP\_First>,...

Creates one or more port pairs for port set embedding. The command can be used repeatedly to extend or (partially) overwrite the list of port sets for embedding.

See [CALCulate<Ch>:TRANSform:VNETworks:PSET:EMBedding<ListId>:DEFine](#) for general port set definition.

**Suffix:**

<Ch>                    Channel number  
 <ListId>               Index of the defined port set within the channel's overall list of port sets for embedding.  
 Port sets for embedding must be numbered consecutively, i.e. port set <ListId> can only be created if port set <ListId>-1 already exists. If several port pairs are specified, <ListId> is the number of the first port pair to be created.

**Parameters:**

<PP\_First>             Sequence of port pairs, each one consisting of two different ports.  
 <PP\_Second>,  
 <PP\_First>, ...

**Example:**

```
See CALCulate<Ch>:TRANSform:VNETworks:PPAir:EMBedding<ListId>[:STATE]
```

**Usage:**

Setting only

**Manual operation:** See ["Add / Delete"](#) on page 494

**CALCulate<Ch>:TRANSform:VNETworks:PPAir:EMBedding<ListId>:DELete**

Deletes all port sets (including port pairs) previously defined for embedding.

**Suffix:**  
 <Ch> Channel number  
 <ListId> This suffix is ignored  
**Example:** See `CALCulate<Ch>:TRANSform:VNETworks:PPAir:EMBedding<ListId>[:STATe]`  
**Usage:** Event  
**Manual operation:** See "Add / Delete" on page 494

**CALCulate<Ch>:TRANSform:VNETworks:PPAir:EMBedding<ListId>:PARAmeters:  
 C<1|2|3> <CircuitModel>, <Capacitance>**  
**CALCulate<Ch>:TRANSform:VNETworks:PPAir:EMBedding<ListId>:PARAmeters:  
 C<1|2|3>? <CircuitModel>**

Specifies the capacitance value C<i> in the different lumped circuit models for port pair embedding.

In the query form, the <Capacitance> parameter must be omitted. The command returns the capacitance value for the specified circuit model.

**Suffix:**  
 <Ch> Channel number  
 <ListId> Index of the affected port pair (see `CALCulate<Ch>:TRANSform:VNETworks:PPAir:DEEMbedding<ListId>:DEFine`)  
 <1|2|3> Index i of the capacitance C<i> in the related lumped circuit model. If unspecified the numeric suffix is set to 1.

**Parameters:**  
 <Capacitance> Capacitance Ci  
 Range: -1 mF to 1 mF  
 Increment: 1 fF (1E-15 F)  
 \*RST: 1 pF (1E-12 F)  
 Default unit: F

**Parameters for setting and query:**  
 <CircuitModel> STSC | SCST | CSSL | LSSC | CSSC | SLCS | SCLS | SCCS | STSG | SGST | GSSL | LSSG | GSSG | SLGS | SGLS | SGGS  
 Circuit model whose capacitance C<i> shall be set, see [Table 11-10](#)

**Example:** See `CALCulate<Ch>:TRANSform:VNETworks:PPAir:EMBedding<ListId>[:STATe]`  
**Manual operation:** See "Network" on page 511

---

**CALCulate<Ch>:TRANSform:VNETworks:PPAir:EMBedding<ListId>:PARAmeters:  
L<1|2|3> <arg0>, <Inductance>**

**CALCulate<Ch>:TRANSform:VNETworks:PPAir:EMBedding<ListId>:PARAmeters:  
L<1|2|3>? <arg0>**

Specifies the inductance value L<i> in the different lumped circuit models for port pair embedding.

In the query form, the <Inductance> parameter must be omitted. The command returns the inductance value for the specified circuit model.

**Suffix:**

|          |                                                                                                                                       |
|----------|---------------------------------------------------------------------------------------------------------------------------------------|
| <Ch>     | Channel number                                                                                                                        |
| <ListId> | Index of the affected port pair (see <a href="#">CALCulate&lt;Ch&gt;:TRANSform:VNETworks:PPAir:DEEMbedding&lt;ListId&gt;:DEFine</a> ) |
| <1 2 3>  | Index i of the inductance L<i> in the related lumped circuit model. If unspecified the numeric suffix is set to 1.                    |

**Parameters:**

|              |                                                                                                               |
|--------------|---------------------------------------------------------------------------------------------------------------|
| <Inductance> | Inductance L<i><br>Range: -1 H to 1 H.<br>Increment: 1 pH (1E-12 H)<br>*RST: 1 nH (1E-9 H)<br>Default unit: H |
|--------------|---------------------------------------------------------------------------------------------------------------|

**Parameters for setting and query:**

|        |                                                                                                                                                                        |
|--------|------------------------------------------------------------------------------------------------------------------------------------------------------------------------|
| <arg0> | STSL   SLST   CSSL   LSSC   LSSL   SLCS   SCLS   SLLS   GSSL   LSSG   SLGS   SGLS<br>Circuit model whose inductance L<i> shall be set, see <a href="#">Table 11-10</a> |
|--------|------------------------------------------------------------------------------------------------------------------------------------------------------------------------|

**Example:** See [CALCulate<Ch>:TRANSform:VNETworks:PPAir:EMBedding<ListId>\[:STATE\]](#)

**Manual operation:** See "Network" on page 511

---

**CALCulate<Ch>:TRANSform:VNETworks:PPAir:EMBedding<ListId>:PARAmeters:  
R<1|2|3> <arg0>, <Resistance>**

**CALCulate<Ch>:TRANSform:VNETworks:PPAir:EMBedding<ListId>:PARAmeters:  
R<1|2|3>? <arg0>**

Specifies the resistance value R<i> in the different lumped circuit models for port pair embedding.

In the query form, the <Resistance> parameter must be omitted. The command returns the resistance value for the specified circuit model.

**Suffix:**

|      |                |
|------|----------------|
| <Ch> | Channel number |
|------|----------------|

|                                          |                                                                                                                                                                                                                                                                   |
|------------------------------------------|-------------------------------------------------------------------------------------------------------------------------------------------------------------------------------------------------------------------------------------------------------------------|
| <ListId>                                 | Index of the affected port pair (see <a href="#">CALCulate&lt;Ch&gt;:TRANSform:VNETworks:PPAir:DEEMbedding&lt;ListId&gt;:DEFine</a> )                                                                                                                             |
| <1 2 3>                                  | Index i of the resistance R<i> in the related lumped circuit model. If unspecified the numeric suffix is set to 1.                                                                                                                                                |
| <b>Parameters:</b>                       |                                                                                                                                                                                                                                                                   |
| <Resistance>                             | Resistance R<i> for the specified circuit model.<br>Range: -10 MΩ to 10 MΩ<br>Increment: 1 mΩ<br>*RST: 0 Ω if the resistance is connected in series with an inductance. 10 MΩ if the resistance is connected in parallel with a capacitance)<br>Default unit: Ohm |
| <b>Parameters for setting and query:</b> |                                                                                                                                                                                                                                                                   |
| <arg0>                                   | STSL   STSC   SLST   SCST   CSSL   LSSC   CSSC   LSSL   SLCS   SCLS   SCCS   SLLS   GSSL   LSSG   SLGS   SGLS<br>Circuit model whose resistance R<i> shall be set, see <a href="#">Table 11-10</a>                                                                |
| <b>Example:</b>                          | See <a href="#">CALCulate&lt;Ch&gt;:TRANSform:VNETworks:PPAir:EMBedding&lt;ListId&gt;[:STATE]</a>                                                                                                                                                                 |
| <b>Manual operation:</b>                 | See " <a href="#">Network</a> " on page 511                                                                                                                                                                                                                       |

---

**CALCulate<Ch>:TRANSform:VNETworks:PPAir:EMBedding<ListId>:PARAmeters:G<1|2|3> <arg0>, <Conductance>**

**CALCulate<Ch>:TRANSform:VNETworks:PPAir:EMBedding<ListId>:PARAmeters:G<1|2|3>? <arg0>**

Specifies the conductance value G<i> in the different lumped circuit models for port pair embedding.

In the query form, the <Conductance> parameter must be omitted. The command returns the conductance value for the specified circuit model.

**Suffix:**

|          |                                                                                                                                       |
|----------|---------------------------------------------------------------------------------------------------------------------------------------|
| <Ch>     | Channel number                                                                                                                        |
| <ListId> | Index of the affected port pair (see <a href="#">CALCulate&lt;Ch&gt;:TRANSform:VNETworks:PPAir:DEEMbedding&lt;ListId&gt;:DEFine</a> ) |
| <1 2 3>  | Index i of the conductance G<i> in the related lumped circuit model. If unspecified the numeric suffix is set to 1.                   |



**Parameters:**

<Conductance> Conductance G<i> for the specified circuit model.  
 Range: -1kS to 1 kS.  
 Increment: 1 pS (1E-12 S)  
 \*RST: 0 S  
 Default unit: Siemens (SI unit symbol: S)

**Parameters for setting and query:**

<arg0> STSG | SGST | GSSL | LSSG | GSSG | SLGS | SGLS | SGGS  
 Circuit model whose conductance G<i> shall be set, see  
[Table 11-10](#)

**Manual operation:** See "[Network](#)" on page 511

**CALCulate<Ch>:TRANSform:VNETworks:PPAir:EMBedding<ListId>:TNDefinition**  
 <CircuitModel>

Selects the circuit model for port pair embedding.

**Suffix:**

<Ch> Channel number  
 <ListId> Index of the affected port pair (see [CALCulate<Ch>:TRANSform:VNETworks:PPAir:EMBedding<ListId>:DEFine](#))

**Parameters:**

<CircuitModel> FIMPort | STSL | STSC | SLST | SCST | CSSL | LSSC | CSSC |  
 LSSL | SLCS | SCLS | SCCS | SLLS | STSG | SGST | GSSL |  
 LSSG | GSSG | SLGS | SGLS | SGGS  
 Circuit model to be used for the addressed port pair, see  
[Table 11-10](#)

**Example:** See [CALCulate<Ch>:TRANSform:VNETworks:PPAir:EMBedding<ListId>\[:STATE\]](#)

**Manual operation:** See "[Network](#)" on page 511

**CALCulate<Ch>:TRANSform:VNETworks:PSET:DEEMbedding<ListId>:DEFine**  
 <Port1>, <Port2>[, <Port3>[, <Port4>]]

**CALCulate<Ch>:TRANSform:VNETworks:PSET:EMBedding<ListId>:DEFine**  
 <Port1>, <Port2>, ...

Defines port set <ListId> for port set deembedding|embedding.

Note that **port pairs** (i.e. 2-element port sets) can also be created using  
[CALCulate<Ch>:TRANSform:VNETworks:PPAir:DEEMbedding<ListId>:DEFine](#) /  
[CALCulate<Ch>:TRANSform:VNETworks:PPAir:EMBedding<ListId>:DEFine](#).

Use `CALCulate<Ch>:TRANSform:VNETworks:PPAir:DEEMbedding:DELeTe / CALCulate<Ch>:TRANSform:VNETworks:PPAir:EMBedding<ListId>:DELeTe` on page 733 to delete all port sets (including port pairs).

**Suffix:**

|          |                                                                                                         |
|----------|---------------------------------------------------------------------------------------------------------|
| <Ch>     | Channel number                                                                                          |
| <ListId> | Index of the defined port set within the channel's overall list of port sets for deembedding/embedding. |

**Parameters:**

<Port1>, <Port2>, ... A port set consist of two or more (different) ports.  
A port can be an element of multiple port sets.

**Manual operation:** See "Add / Delete" on page 494

### `CALCulate<Ch>:TRANSform:VNETworks:SENDEd:DEEMbedding<PhyPt>[: STATE] <Boolean>`

Enables or disables the deembedding function for single ended ports. It is allowed to change the circuit model and its parameters while deembedding is enabled.

**Suffix:**

|         |                      |
|---------|----------------------|
| <Ch>    | Channel number       |
| <PhyPt> | Physical port number |

**Parameters:**

<Boolean> ON - deembedding active  
OFF - deembedding inactive  
\*RST: OFF

**Example:**

```
CALC:TRAN:VNET:SEND:DEEM:TND CSL
```

Select the Serial C, shunt L circuit model for deembedding.

```
CALC:TRAN:VNET:SEND:DEEM:PAR:R2 CSL, 2.2E+3; :
```

```
CALC:TRAN:VNET:SEND:DEEM ON
```

Increase the resistance R2 for the Serial C, shunt L circuit model to 2.2 kΩ and enable deembedding.

**Manual operation:** See "Active" on page 493

### `CALCulate<Ch>:TRANSform:VNETworks:SENDEd:DEEMbedding<PhyPt>:PARAMeters:DATA <Interchange>, <arg1>`

Defines an embedding network for a single-ended port based on the given S-Parameter traces.

**Use**

- `CALCulate<Ch>:TRANSform:VNETworks:SENDEd:DEEMbedding<PhyPt>:TNDefinition` to select the adequate circuit model **before** executing this command.
- `MMEMory:LOAD:VNETworks<Ch>:SENDEd:DEEMbedding<PhyPt>` to load circuit data from a Touchstone file located at the R&S ZNL/ZNLE's file system.

**Suffix:**

|         |                      |
|---------|----------------------|
| <Ch>    | Channel number       |
| <PhyPt> | Physical port number |

**Setting parameters:**

|               |                                                                                                                                                                                                                                                        |
|---------------|--------------------------------------------------------------------------------------------------------------------------------------------------------------------------------------------------------------------------------------------------------|
| <Interchange> | FPORts   IPORts   SGATes<br><b>FPORts (or omitted)</b><br>Standard port sequence (network port 1 towards VNA, network port 2 towards DUT)<br><b>IPORts   SGATes</b><br>Inverted port sequence (network port 2 towards VNA, network port 1 towards DUT) |
|---------------|--------------------------------------------------------------------------------------------------------------------------------------------------------------------------------------------------------------------------------------------------------|

|        |                                                                                                       |
|--------|-------------------------------------------------------------------------------------------------------|
| <arg1> | <block_data><br>Content of a Touchstone file (*.s2p) in IEEE488.2 <a href="#">Block Data Format</a> . |
|--------|-------------------------------------------------------------------------------------------------------|

|               |              |
|---------------|--------------|
| <b>Usage:</b> | Setting only |
|---------------|--------------|

**CALCulate<Ch>:TRANSform:VNETworks:SENDED:DEEMbedding<PhyPt>:  
PARAMeters:C<Cmp>** <CircuitModel>, <Capacitance>

**CALCulate<Ch>:TRANSform:VNETworks:SENDED:DEEMbedding<PhyPt>:  
PARAMeters:C<Cmp>?** <CircuitModel>

Specifies the capacitance value C<Cmp> in the different circuit models for single ended port embedding.

In the query form, the <Capacitance> parameter must be omitted. The command returns the capacitance value for the specified circuit model.

**Suffix:**

|         |                                                                                                                 |
|---------|-----------------------------------------------------------------------------------------------------------------|
| <Ch>    | Channel number                                                                                                  |
| <PhyPt> | Physical port number                                                                                            |
| <Cmp>   | Number of capacitance in circuit model. The total number of capacitances depends on the selected circuit model. |

**Parameters:**

|               |                                                                                                                                                     |
|---------------|-----------------------------------------------------------------------------------------------------------------------------------------------------|
| <Capacitance> | Capacitance C<Cmp> for the specified circuit model.<br>Range: -1mF to 1 mF.<br>Increment: 1 fF (1E-15 F)<br>*RST: 1 pF (1E-12 F)<br>Default unit: F |
|---------------|-----------------------------------------------------------------------------------------------------------------------------------------------------|

**Parameters for setting and query:**

|                |                                                                                                                                                            |
|----------------|------------------------------------------------------------------------------------------------------------------------------------------------------------|
| <CircuitModel> | CSL   LSC   CSC   SLC   SCL   SCC   SHLC   GSL   LSG   GSG   SLG   SGL   SGG<br>Possible circuit models (character data); see <a href="#">Table 11-9</a> . |
|----------------|------------------------------------------------------------------------------------------------------------------------------------------------------------|

**Example:** `*RST; :CALC:TRAN:VNET:SEND:DEEM:PAR:C2? CSC`  
 Query the default capacitance C2 for the Serial C, shunt C circuit model. The response is 1E-012 (1 pF).  
`CALC:TRAN:VNET:SEND:DEEM:PAR:C2 CSC, 2.2E-12`  
 Increase the capacitance to 2.2 pF.

**Manual operation:** See "[Network](#)" on page 509

**CALCulate<Ch>:TRANSform:VNETworks:SENDEd:DEEMbedding<PhyPt>:  
 PARAmeters:G<Cmp>** <CircuitModel>, <Conductance>

**CALCulate<Ch>:TRANSform:VNETworks:SENDEd:DEEMbedding<PhyPt>:  
 PARAmeters:G<Cmp>?** <CircuitModel>

Specifies the conductance value G in the "shunt L, shunt C" circuit model for single ended port deembedding.

In the query form, the <Conductance> parameter must be omitted.

**Suffix:**

<Ch> Channel number

<PhyPt> Physical port number

<Cmp> Number of the conductance component in the circuit model. The total number of conductances depends on the selected circuit model.

**Parameters:**

<Conductance> Conductance G<Cmp> for the specified circuit model.  
 Range: -1kS to 1 kS.  
 Increment: 1 nS (1E-9 S)  
 \*RST: 0 S  
 Default unit: Siemens (SI unit symbol: S)

**Parameters for setting and query:**

<CircuitModel> SHLC  
 Circuit model whose conductance G<Cmp> shall be set, see [Table 11-9](#).

**Example:** `*RST; :CALC:TRAN:VNET:SEND:DEEM:PAR:L? SHLC; R?  
 SHLC; C? SHLC; G? SHLC`  
 Query the default component values for the "shunt L, shunt C" circuit model.  
`CALC:TRAN:VNET:SEND:DEEM:PAR:G SHLC, 1`  
 Increase the conductance G to 1 Siemens.

**Manual operation:** See "[Network](#)" on page 509

---

**CALCulate<Ch>:TRANSform:VNETworks:SENDED:DEEMbedding<PhyPt>:  
PARAMeters:L<Cmp> <CircuitModel>, <Inductance>**  
**CALCulate<Ch>:TRANSform:VNETworks:SENDED:DEEMbedding<PhyPt>:  
PARAMeters:L<Cmp>? <CircuitModel>**

Specifies the inductance value L<Cmp> in the different circuit models for single ended port deembedding.

In the query form, the <Inductance> parameter must be omitted. The command returns the inductance value for the specified circuit model.

**Suffix:**

|         |                                                                                                               |
|---------|---------------------------------------------------------------------------------------------------------------|
| <Ch>    | Channel number                                                                                                |
| <PhyPt> | Physical port number                                                                                          |
| <Cmp>   | Number of inductance in circuit model. The total number of inductances depends on the selected circuit model. |

**Parameters:**

|              |                                                                                                                                                 |
|--------------|-------------------------------------------------------------------------------------------------------------------------------------------------|
| <Inductance> | Inductance L<Cmp> for the specified circuit model.<br>Range: -1H to 1 H.<br>Increment: 1 pH (1E-12 H)<br>*RST: 1 nH (1E-9 H)<br>Default unit: H |
|--------------|-------------------------------------------------------------------------------------------------------------------------------------------------|

**Parameters for setting and query:**

|                |                                                                                                                                                |
|----------------|------------------------------------------------------------------------------------------------------------------------------------------------|
| <CircuitModel> | CSL   LSC   LSL   SLC   SCL   SLL   SHLC   GSL   LSG   SLG   SGL<br>Possible circuit models (character data); see <a href="#">Table 11-9</a> . |
|----------------|------------------------------------------------------------------------------------------------------------------------------------------------|

**Example:**

```
*RST; :CALC:TRAN:VNET:SEND:DEEM:PAR:L1? SLL
Query the default inductance L1 for the Shunt L, serial L circuit
model. The response is 1E-009 (1 nH).
CALC:TRAN:VNET:SEND:DEEM:PAR:L1 SLL, 2.2E-9
Increase the inductance to 2.2 nH.
```

**Manual operation:** See "[Network](#)" on page 509

---

**CALCulate<Ch>:TRANSform:VNETworks:SENDED:DEEMbedding<PhyPt>:  
PARAMeters:R<Cmp> <CircuitModel>, <Resistance>**  
**CALCulate<Ch>:TRANSform:VNETworks:SENDED:DEEMbedding<PhyPt>:  
PARAMeters:R<Cmp>? <CircuitModel>**

Specifies the resistance value R<Cmp> in the different circuit models for single ended port deembedding.

In the query form, the <Resistance> parameter must be omitted. The command returns the resistance value for the specified circuit model.

**Suffix:**

|         |                      |
|---------|----------------------|
| <Ch>    | Channel number       |
| <PhyPt> | Physical port number |

<Cmp> Number of resistance in circuit model. The total number of resistances depends on the selected circuit model.

**Parameters:**

<Resistance> Resistance R<Cmp> for the specified circuit model.  
 Range: -10 MΩ to 10 MΩ.  
 Increment: 1 mΩ (1E-3 Ω)  
 \*RST: 0 Ω for all resistances connected in series with an inductance. 10 MΩ for all resistances connected in parallel with a capacitance  
 Default unit: Ohm

**Parameters for setting and query:**

<CircuitModel> CSL | LSC | CSC | LSL | SLC | SCL | SCC | SLL | SHLC | GSL | LSG | SLG | SGL  
 Possible circuit models (character data); see [Table 11-9](#).

**Example:**

```
*RST; :CALC:TRAN:VNET:SEND:DEEM:PAR:R1? CSL;
R2? CSL
```

Query the default resistances for the Serial C, shunt L circuit model. The response is 10000000; 0.

```
CALC:TRAN:VNET:SEND:DEEM:PAR:R2 CSL, 2.2E+3
```

Increase the resistance R2 to 2.2 kΩ.

**Manual operation:** See ["Network"](#) on page 509

### **CALCulate<Ch>:TRANSform:VNETworks:SENDEd:DEEMbedding<PhyPt>:TNDefinition <CircuitModel>**

Selects the circuit model for single ended port deembedding.

**Suffix:**

<Ch> Channel number  
 <PhyPt> Physical port number

**Parameters:**

<CircuitModel> FIMPort | CSL | LSC | CSC | LSL | SLC | SCL | SCC | SLL | SHLC | GSL | LSG | GSG | SLG | SGL | SGG  
 Possible circuit models (character data); see [Table 11-9](#)  
 \*RST: CSL

**Example:**

```
See CALCulate<Ch>:TRANSform:VNETworks:SENDEd:
DEEMbedding<PhyPt>[:STATE]
```

**Manual operation:** See ["Network"](#) on page 509

### **CALCulate<Ch>:TRANSform:VNETworks:SENDEd:EMBEdding<PhyPt>[:STATE] <Boolean>**

Enables or disables the embedding function for single ended ports. It is allowed to change the circuit model and its parameters while embedding is enabled.

**Suffix:**

<Ch> Channel number  
 <PhyPt> Physical port number

**Parameters:**

<Boolean> ON - embedding active  
 OFF - embedding inactive  
 \*RST: OFF

**Example:**

```
CALC:TRAN:VNET:SEND:EMB:TND CSL
Select the Serial C, shunt L circuit model for embedding.
CALC:TRAN:VNET:SEND:EMB:PAR:R2 CSL, 2.2E+3; :
CALC:TRAN:VNET:SEND:EMB ON
Increase the resistance R2 for the Serial C, shunt L circuit model
to 2.2 kΩ and enable embedding.
```

**Manual operation:** See "[Active](#)" on page 493

**CALCulate<Ch>:TRANSform:VNETworks:SENDED:EMBedding<PhyPt>:  
 PARameters:DATA <Interchange>, <arg1>**

Defines a dembedding network for a single-ended port based on the given S-Parameter traces.

**Use**

- `CALCulate<Ch>:TRANSform:VNETworks:SENDED:EMBedding<PhyPt>:TNDefinition` to select the adequate circuit model **before** executing this command.
- `MMEMemory:LOAD:VNETworks<Ch>:SENDED:EMBedding<PhyPt>` to load circuit data from a Touchstone file located at the R&S ZNL/ZNLE's file system.

**Suffix:**

<Ch> Channel number  
 <PhyPt> Physical port number

**Setting parameters:**

<Interchange> FPORts | IPORts | SGATes  
**FPORts (or omitted)**  
 Standard port sequence (network port 1 towards VNA, network port 2 towards DUT)  
**IPORts | SGATes**  
 Inverted port sequence (network port 2 towards VNA, network port 1 towards DUT)

<arg1> <block\_data>  
 Content of a Touchstone file (\*.s2p or \*.s4p) in IEEE488.2 [Block Data Format](#).

**Usage:** Setting only

---

**CALCulate<Ch>:TRANSform:VNETworks:SENDED:EMBedding<PhyPt>:  
PARAMeters:C<Cmp>** <CircuitModel>, <Capacitance>  
**CALCulate<Ch>:TRANSform:VNETworks:SENDED:EMBedding<PhyPt>:  
PARAMeters:C<Cmp>?** <CircuitModel>

Specifies the capacitance value C<Cmp> in the different circuit models for single ended port embedding.

In the query form, the <Capacitance> parameter must be omitted. The command returns the capacitance value for the specified circuit model.

**Suffix:**

|         |                                                                                                                 |
|---------|-----------------------------------------------------------------------------------------------------------------|
| <Ch>    | Channel number                                                                                                  |
| <PhyPt> | Physical port number                                                                                            |
| <Cmp>   | Number of capacitance in circuit model. The total number of capacitances depends on the selected circuit model. |

**Parameters:**

|               |                                                                                                                                                     |
|---------------|-----------------------------------------------------------------------------------------------------------------------------------------------------|
| <Capacitance> | Capacitance C<Cmp> for the specified circuit model.<br>Range: -1mF to 1 mF.<br>Increment: 1 fF (1E-15 F)<br>*RST: 1 pF (1E-12 F)<br>Default unit: F |
|---------------|-----------------------------------------------------------------------------------------------------------------------------------------------------|

**Parameters for setting and query:**

|                |                                                                                                                                                               |
|----------------|---------------------------------------------------------------------------------------------------------------------------------------------------------------|
| <CircuitModel> | CSL   LSC   CSC   SLC   SCL   SCC   SHLC   GSL   LSG  <br>GSG   SLG   SGL   SGG<br>Possible circuit models (character data); see <a href="#">Table 11-9</a> . |
|----------------|---------------------------------------------------------------------------------------------------------------------------------------------------------------|

**Example:**

```
*RST; :CALC:TRAN:VNET:SEND:EMB:PAR:C2? CSC
Query the default capacitance C2 for the Serial C, shunt C cir-
cuit model. The response is 1E-012 (1 pF).
CALC:TRAN:VNET:SEND:EMB:PAR:C2 CSC, 2.2E-12
Increase the capacitance to 2.2 pF.
```

**Manual operation:** See "[Network](#)" on page 509

---

**CALCulate<Ch>:TRANSform:VNETworks:SENDED:EMBedding<PhyPt>:  
PARAMeters:G<Cmp>** <CircuitModel>, <Conductance>  
**CALCulate<Ch>:TRANSform:VNETworks:SENDED:EMBedding<PhyPt>:  
PARAMeters:G<Cmp>?** <CircuitModel>

Specifies the conductance value G<Cmp> in the different circuit models for single ended port embedding.

In the query form, the <Conductance> parameter must be omitted. The command returns the conductance value for the specified circuit model.

**Suffix:**

|         |                      |
|---------|----------------------|
| <Ch>    | Channel number       |
| <PhyPt> | Physical port number |



<Cmp> Number of the conductance component in the circuit model. The total number of conductances depends on the selected circuit model.

**Parameters:**

<Conductance> Conductance G<Cmp> for the specified circuit model.  
 Range: -1kS to 1 kS.  
 Increment: 1 pS (1E-12 S)  
 \*RST: 0 S  
 Default unit: Siemens (SI unit symbol: S)

**Parameters for setting and query:**

<CircuitModel> GSL | LSG | GSG | SLG | SGL | SGG | SHLC  
 Circuit model whose conductance G<Cmp> shall be set, see [Table 11-9](#).

**Example:**

```
*RST; :CALC:TRAN:VNET:SEND:EMB:PAR:L? SHLC; R?
SHLC; C? SHLC; G? SHLC
Query the default component values for the "shunt L, shunt C"
circuit model.
CALC:TRAN:VNET:SEND:EMB:PAR:G SHLC, 1
Increase the conductance G to 1 Siemens.
```

**Manual operation:** See "[Network](#)" on page 509

**CALCulate<Ch>:TRANSform:VNETworks:SENDEd:EMBedding<PhyPt>:  
 PARAmeters:L<Cmp> <CircuitModel>, <Inductance>**  
**CALCulate<Ch>:TRANSform:VNETworks:SENDEd:EMBedding<PhyPt>:  
 PARAmeters:L<Cmp>? <CircuitModel>**

Specifies the inductance value L<Cmp> in the different circuit models for single ended port embedding.

In the query form, the <Inductance> parameter must be omitted. The command returns the inductance value for the specified circuit model.

**Suffix:**

<Ch> Channel number  
 <PhyPt> Physical port number  
 <Cmp> Number of inductance in circuit model. The total number of inductances depends on the selected circuit model.

**Parameters:**

<Inductance> Inductance L<Cmp> for the specified circuit model.  
 Range: -1H to 1 H.  
 Increment: 1 pH (1E-12 H)  
 \*RST: 1 nH (1E-9 H)  
 Default unit: H

**Parameters for setting and query:**

<CircuitModel> CSL | LSC | LSL | SLC | SCL | SLL | SHLC | GSL | LSG | SLG | SGL

Possible circuit models (character data); see [Table 11-9](#).

**Example:**

```
*RST; :CALC:TRAN:VNET:SEND:EMB:PAR:L1? SLL
Query the default inductance L1 for the Shunt L, serial L circuit
model. The response is 1E-009 (1 nH).
CALC:TRAN:VNET:SEND:EMB:PAR:L1 SLL, 2.2E-9
Increase the inductance to 2.2 nH.
```

**Manual operation:** See "[Network](#)" on page 509

**CALCulate<Ch>:TRANSform:VNETworks:SENDED:EMBedding<PhyPt>:**

**PARAMeters:R<Cmp>** <CircuitModel>, <Resistance>

**CALCulate<Ch>:TRANSform:VNETworks:SENDED:EMBedding<PhyPt>:**

**PARAMeters:R<Cmp>?** <CircuitModel>

Specifies the resistance value R<Cmp> in the different circuit models for single ended port embedding.

In the query form, the <Resistance> parameter must be omitted. The command returns the resistance value for the specified circuit model.

**Suffix:**

<Ch> Channel number  
 <PhyPt> Physical port number  
 <Cmp> Number of resistance in circuit model. The total number of resistances depends on the selected circuit model.

**Parameters:**

<Resistance> Resistance R<Cmp> for the specified circuit model.  
 Range: -10 MΩ to 10 MΩ.  
 Increment: 1 mΩ (1E-3 Ω)  
 \*RST: 0 Ω for all resistances connected in series with an inductance. 10 MΩ for all resistances connected in parallel with a capacitance  
 Default unit: Ohm

**Parameters for setting and query:**

<CircuitModel> CSL | LSC | CSC | LSL | SLC | SCL | SCC | SLL | SHLC | GSL | LSG | SLG | SGL

Possible circuit models (character data); see [Table 11-9](#).

**Example:**

```
*RST; :CALC:TRAN:VNET:SEND:EMB:PAR:R1? CSL; R2?
CSL
Query the default resistances for the Serial C, shunt L circuit
model. The response is 10000000; 0.
CALC:TRAN:VNET:SEND:EMB:PAR:R2 CSL, 2.2E+3
Increase the resistance R2 to 2.2 kΩ.
```

**Manual operation:** See "[Network](#)" on page 509

---

**CALCulate<Ch>:TRANSform:VNETworks:SENDED:EMBedding<PhyPt>:  
TNDefinition <CircuitModel>**

Selects the circuit model for single ended port embedding.

**Suffix:**

<Ch> Channel number  
<PhyPt> Physical port number

**Parameters:**

<CircuitModel> FIMPort | CSL | LSC | CSC | LSL | SLC | SCL | SCC | SLL |  
SHLC | GSL | LSG | GSG | SLG | SGL | SGG  
Possible circuit models (character data); see [Table 11-9](#)  
\*RST: CSL

**Example:** See `CALCulate<Ch>:TRANSform:VNETworks:SENDED:  
EMBedding<PhyPt>[:STATe]`

**Manual operation:** See "Network" on page 509

### 11.5.2.2 CONFigure Commands

The `CONFigure...` commands create and delete channels or traces, assign channel and trace names, and define the channel sweep order. The commands are device-specific.

|                                                                |     |
|----------------------------------------------------------------|-----|
| <code>CONFigure:CHANnel:CATalog?</code> .....                  | 747 |
| <code>CONFigure:CHANnel:MEASure:ALL[:STATe]</code> .....       | 748 |
| <code>CONFigure:CHANnel:MEASure:OPTimized</code> .....         | 748 |
| <code>CONFigure:CHANnel&lt;Ch&gt;[:STATe]</code> .....         | 749 |
| <code>CONFigure:CHANnel&lt;Ch&gt;:MEASure[:STATe]</code> ..... | 750 |
| <code>CONFigure:CHANnel&lt;Ch&gt;:NAME</code> .....            | 750 |
| <code>CONFigure:CHANnel&lt;Ch&gt;:NAME:ID?</code> .....        | 751 |
| <code>CONFigure:CHANnel&lt;Ch&gt;:TRACe:REName</code> .....    | 751 |
| <code>CONFigure:CHANnel&lt;Ch&gt;:TRACe:CATalog?</code> .....  | 751 |
| <code>CONFigure:TRACe:CATalog?</code> .....                    | 752 |
| <code>CONFigure:TRACe:WINDow?</code> .....                     | 752 |
| <code>CONFigure:TRACe:WINDow:TRACe?</code> .....               | 753 |
| <code>CONFigure:TRACe&lt;Trc&gt;:CHANnel:NAME?</code> .....    | 753 |
| <code>CONFigure:TRACe&lt;Trc&gt;:CHANnel:NAME:ID?</code> ..... | 753 |
| <code>CONFigure:TRACe&lt;Trc&gt;:NAME</code> .....             | 754 |
| <code>CONFigure:TRACe&lt;Trc&gt;:NAME:ID?</code> .....         | 754 |
| <code>CONFigure:TRACe&lt;Trc&gt;:REName</code> .....           | 754 |

---

**CONFigure:CHANnel:CATalog?**

Returns the numbers and names of all channels in the current channel setup. The response is a string containing a comma-separated list of channel numbers and names; see example below. If all channels have been deleted the response is an empty string ("").

**Example:**            \*RST; :CONF:CHAN2:STAT ON; NAME 'New Channel'  
 Create channel 2 and assign the channel name "New Channel".  
 CONF:CHAN:CAT?  
 Query all channels and their names. As a default channel no. 1  
 is created on \*RST, the response is  
 '1,Ch1,2,New\_Channel'.  
 CONF:CHAN:NAME:ID? 'New Channel'  
 Query the channel number for the channel named "New Chan-  
 nel". The response is 2.

**Usage:**            Query only

**Manual operation:** See "[Channel table](#)" on page 486

#### **CONFigure:CHANnel:MEASure:ALL[:STATe]** <Boolean>

Enables or disables the sweep in all channels of the active channel setup. This command can be used in combination with [CONFigure:CHANnel<Ch>:MEASure\[:STATe\]](#) to optimize the measurement speed.

#### **Parameters:**

<Boolean>            ON | OFF  
 \*RST:                ON

**Example:**            See [CONFigure:CHANnel<Ch>:MEASure\[:STATe\]](#)

**Manual operation:** See "[Continuous / Single](#)" on page 327

#### **CONFigure:CHANnel:MEASure:OPTimized** <Order>[, <Ch1>, <Ch2>, ...]

This setting tells the firmware to optimize the channel switching times for a particular channel sweep order.

**Note** that the optimization can only be applied, if **all** channels in the current setup are in single sweep mode ([INITiate<Ch>:CONTinuous OFF](#), and if there is no ongoing sweep sequence. Any change in the current setup or a wrong sweep sequence lets the analyzer fall back to unoptimized channel switching.

#### **Setting parameters:**

<Order>                AUTO | MANual  
**AUTO**  
 Optimize the switching times for the channel order that is automatically used with [INIT:ALL](#) (increasing order of channel numbers).  
**MANual**  
 Optimize the switching times for the channel order manually specified using channel numbers <Ch1>, <Ch2>, ...

<Ch1>, <Ch2>, ... Can only and must be specified for MANual optimized channel ordering. Defines the order in which the channels are measured. To get the optimization to work, you have to sweep the channels manually, and in the specified order: `INIT<Ch1>`, `INIT<Ch2>`, ...

**Example:**

```
*RST;
*RST creates channel 1, trace 1, and diagram 1.
:INITiate1:CONTinuous OFF
enable single sweep mode
CALC2:PAR:SDEF 'Ch2Tr1', 'S11'
CALC3:PAR:SDEF 'Ch3Tr1', 'S11'
CALC4:PAR:SDEF 'Ch4Tr1', 'S11'

create additional channels 2, 3 and 4 with one trace each
DISP:WIND1:TRAC2:FEED 'CH2TR1'
DISP:WIND1:TRAC3:FEED 'CH3TR1'
DISP:WIND1:TRAC4:FEED 'CH4TR1'

assign these traces to diagram 1
:CONF:CHAN:MEAS:OPT AUTO; :INITiate1:IMMediate:
ALL
optimize the switching times for the AUTOMatic channel order
1,2,3,4, and restart the sweep in all channels
:CONF:CHAN:MEAS:OPT MAN, 2,3,1,4; :INIT2; :
INIT3; :INIT1; :INIT4
optimize the switching times for channel order 2,3,1,4 and
restart the sweeps in the same order
```

**Usage:**

Setting only

**CONFigure:CHANnel<Ch>[:STATe] <Boolean>**

Creates or deletes channel no. <Ch> and selects it as the active channel.

`CONFigure:CHANnel<Ch>:NAME` defines the channel name.

A channel created using `CONFigure:CHANnel<Ch>[:STATe] ON` can be configured but has no trace assigned so that no measurement can be initiated. Use `CALCulate<Ch>:PARAMeter:SDEFine <TraceName>, <Result>` to create a channel and a trace. In remote control, it is possible to remove all channels. This is in contrast to manual control where at least one channel with one diagram area and one trace must be available.

**Suffix:**

<Ch> Number of the channel to be created or deleted.

**Parameters:**

<Boolean> ON - create channel no. <Ch>. If the channel no. <Ch> exists already, it is not modified but selected as the active channel.  
OFF - delete channel no. <Ch>.

\*RST: ON for channel no. 1 (created on \*RST), OFF for all other channels.

**Example:** See [CONFigure:CHANnel:CATalog?](#)

**Manual operation:** See "New Channel" on page 484

### **CONFigure:CHANnel<Ch>:MEASure[:STATe] <Boolean>**

Enables or disables the sweep in channel no. <Ch>. This command can be used to restrict the measurement in a subset of channels in order to optimize the measurement speed.

**Suffix:**

<Ch> Number of an existing channel.

**Parameters:**

<Boolean> ON | OFF

\*RST: ON (all existing channels)

**Example:**

```
*RST; :CONFigure:CHANnel2 ON; CHANnel3 ON
Create channels 2 and 3, in addition to the default channel no.
1. The analyzer performs sweeps in all three channels.
CONFigure:CHANnel:MEASure:ALL OFF
Disable the measurement in all channels
CONFigure:CHANnel2:MEASure ON
(Re-)enable the measurement in channel no. 2. The analyzer
measures in channel 2; the channels no. 1 and 3 are not mea-
sured.
```

**Manual operation:** See "Continuous / Single" on page 327

### **CONFigure:CHANnel<Ch>:NAME <ChannelName>**

Assigns a name to channel number <Ch>. The channel must be created before ([CONFigure:CHANnel<Ch>\[:STATe\] ON](#)). Moreover it is not possible to assign the same name to two different channels. [CONFigure:CHANnel:CATalog?](#) returns a list of all defined channels with their names.

**Suffix:**

<Ch> Number of an existing channel.

**Parameters:**

<ChannelName> Channel name, e.g. 'Channel 4'.

\*RST: 'Ch1'

**Example:** See [CONFigure:CHANnel:CATalog?](#)

**Manual operation:** See "Channel table" on page 486

**CONFigure:CHANnel<Ch>:NAME:ID? <ChannelName>**

Queries the channel number (numeric suffix) of a channel with known channel name. A channel name must be assigned before ([CONFigure:CHANnel<Ch>:NAME <ChannelName>](#)). [CONFigure:CHANnel:CATalog?](#) returns a list of all defined channels with their names.

**Suffix:**

<Ch> Channel number. This suffix is not relevant and may be omitted (the command returns the actual channel number).

**Query parameters:**

<ChannelName> Channel name, e.g. 'Channel 4'.

**Example:** See [CONFigure:CHANnel:CATalog?](#)

**Usage:** Query only

**Manual operation:** See "[Table Area](#)" on page 333

**CONFigure:CHANnel<Ch>:TRACe:REName <TraceName>**

Assigns a (new) name to the active trace in channel <Ch>.

**Suffix:**

<Ch> Channel number

**Setting parameters:**

<TraceName> Trace name, e.g. 'Trace 4'.

**Example:**

```
*RST; :CONF:CHAN:TRAC:REN 'Testtrace_1'
Reset the analyzer to create a default trace in channel 1 and set
this trace as the active trace. Rename the trace 'Testtrace_1'.
CALC:PAR:SDEF 'Testtrace_2', 'S11'
Create a new trace which will become the active trace in chan-
nel no. 1.
CONF:TRAC:REN 'Testtrace_1', 'Testtrace_3'
Rename the first trace (which is currently not active) 'Test-
trace_3'.
```

**Usage:** Setting only

**Manual operation:** See "[Table Area](#)" on page 333

**CONFigure:CHANnel<Ch>:TRACe:CATalog?**

Returns the numbers and names of all traces in channel no. <Ch>. The response is a string containing a comma-separated list of trace numbers and names; see example. If all traces have been deleted the response is an empty string ("").

**Tip:** Use [CONFigure:TRACe:CATalog?](#) to query the traces in all channels of the active channel setup.

**Suffix:**

<Ch> Channel number

**Example:** See [CONFigure:TRACe:CATalog?](#)

**Usage:** Query only

**Manual operation:** See "[Table Area](#)" on page 333

### CONFigure:TRACe:CATalog?

Returns the numbers and names of all traces in the current channel setup. The response is a string containing a comma-separated list of trace numbers and names, see example below. If all traces have been deleted the response is an empty string ("").

**Tip:** Use [CONFigure:CHANnel<Ch>:TRACe:CATalog?](#) to query the traces in a particular channel; see example.

**Example:**

```
*RST; :CALC2:PAR:SDEF 'Ch2Trc2', 'S11'
```

Create channel 2 and a new trace named Ch2Trc2.

```
CONF:TRAC:CAT?
```

Query all traces and their names. As a default trace no. 1 is created upon \*RST, the response is '1,Trc1,2,Ch2Trc2'.

```
CONF:CHAN1:TRAC:CAT?
```

Query the channels in channel no. 1. The response is '1,Trc1'.

```
CONF:TRAC:NAME:ID? 'Ch2Trc2'
```

Query the trace number for the trace named "Ch2Trc2". The response is 2.

```
CONF:TRAC2:NAME?
```

Query the trace name for trace no. 2. The response is 'Ch2Trc2'.

```
CONF:TRAC:CHAN:NAME? 'Ch2Trc2'
```

Query the channel name for trace Ch2Trc2. The response is 'Ch2'.

```
CONF:TRAC:CHAN:NAME:ID? 'Ch2Trc2'
```

Query the channel number for trace Ch2Trc2. The response is 2.

**Usage:** Query only

**Manual operation:** See "[Table Area](#)" on page 333

### CONFigure:TRACe:WINDow? <TraceName>

Returns the trace number within a diagram which is assigned to the trace <TraceName> is assigned to. A zero is returned when the trace is not assigned/displayed.

The trace number is equal to the <WndTr> suffix in [DISPlay\[:WINDow<Wnd>\]:TRACe<WndTr>:FEED](#) and similar commands; see example.

#### Query parameters:

<TraceName> Trace name (string), e.g. 'Trc1'

**Example:** See [CONFigure:TRACe:WINDow:TRACe?](#)



**Usage:** Query only

---

**CONFigure:TRACe:WINDow:TRACe? <TraceName>**

Returns the number of the diagram which the trace <TraceName> is assigned to. A zero is returned when the trace is not assigned/displayed.

The diagram number is equal to the <Wnd> suffix in `DISPlay[:WINDow<Wnd>]:TRACe<WndTr>:FEED` and similar commands; see example.

**Query parameters:**

<TraceName> Trace name (string), e.g. 'Trc1'

**Example:**

```
*RST; :CALC:PAR:SDEF 'Trc2', 'S11'
```

Create a trace named Trc2.

```
CONF:TRAC:WIND:TRAC? 'Trc2'
```

Query the diagram number for Trc2. The new trace is not displayed, so the response is 0.

```
DISP:WIND2:STAT ON
```

Create a diagram no. 2.

```
DISP:WIND2:TRAC3:FEED 'Trc2'
```

Display the trace in the new diagram no. 2, assigning the trace number 3.

```
CONF:TRAC:WIND? 'Trc2'
```

Query the diagram number for Trc2. The response is 2.

```
CONF:TRAC:WIND:TRAC? 'Trc2'
```

Query the trace number for Trc2. The response is 3.

**Usage:** Query only

**Manual operation:** See "[Table Area](#)" on page 333

---

**CONFigure:TRACe<Trc>:CHANnel:NAME? <TraceName>**

Queries the channel name for an existing trace named '<TraceName>'.

**Suffix:**

<Trc> Trace number. This suffix is ignored; the trace is referenced by its name.

**Query parameters:**

<TraceName> Trace name, e.g. 'Ch2Trc2'.

**Example:**

See `CONFigure:TRACe:CATalog?`

**Usage:** Query only

**Manual operation:** See "[New Channel](#)" on page 484

---

**CONFigure:TRACe<Trc>:CHANnel:NAME:ID? <TraceName>**

Queries the channel number (numeric suffix) for an existing trace named '<TraceName>'.

**Suffix:**  
 <Trc> Trace number. This suffix is ignored; the trace is referenced by its name.

**Query parameters:**  
 <TraceName> Trace name, e.g. 'Ch2Trc2'.

**Example:** See [CONFigure:TRACe:CATalog?](#)

**Usage:** Query only

**Manual operation:** See "New Channel" on page 484

#### **CONFigure:TRACe<Trc>:NAME <TraceName>**

Assigns a name to an existing trace number <Trc>. Note that it is not possible to assign the same name to two different traces. [CONFigure:TRACe:CATalog?](#) returns a list of all traces in the active channel setup with their names.

**Suffix:**  
 <Trc> Number of an existing trace.

**Parameters:**  
 <TraceName> Trace name, e.g. 'Ch2Trc2'.  
 \*RST: 'Trc1'

**Example:** See [CONFigure:TRACe:CATalog?](#)

#### **CONFigure:TRACe<Trc>:NAME:ID? <TraceName>**

Queries the trace number (numeric suffix) of a trace with known trace name. [CONFigure:TRACe:CATalog?](#) returns a list of all traces in the active channel setup with their names.

**Suffix:**  
 <Trc> Trace number. This suffix is not relevant and may be omitted (the command returns the actual trace number).

**Query parameters:**  
 <TraceName> Trace name, e.g. 'Ch2Trc2'.

**Example:** See [CONFigure:TRACe:CATalog?](#)

**Usage:** Query only

#### **CONFigure:TRACe<Trc>:REName <OldTraceName>, <NewTraceName>**

Assigns a new name to a trace. The trace does not have to be the active trace.

**Suffix:**  
 <Trc> Trace number. This suffix is ignored; the trace is identified via its <TraceName>

**Setting parameters:**

<OldTraceName> String parameter with old trace name, e.g. 'Trc1'  
 <NewTraceName> String parameter with new trace name, e.g. 'S11 Trace'  
 \*RST: n/a

**Example:** See [CONFigure:CHANnel<Ch>:TRACe:REName](#)

**Usage:** Setting only

**Manual operation:** See "[Table Area](#)" on page 333

**11.5.2.3 CONTrol Commands**

The `Control...` commands allow you to configure the following interfaces:

- Aux. Port



- The VNA User Port functionality is offered at the Aux. Port connector that is provided by hardware option R&S FPL1-B5 "Additional Interfaces". This option is not available for the R&S ZNLE
- Usage of the Aux. Port as VNA User Port (instead of SA Auxiliary Port) must be selected in the "Add. Interfaces" tab of the "System Configuration" dialog.

[CONTrol:AUXiliary:C\[:DATA\]](#)..... 755

**CONTrol:AUXiliary:C[:DATA] <DecValue>**

Sets or queries a channel-dependent eight-bit decimal value to control eight independent output signals at the Aux. Port connector (lines 8, 9, 10, 11 and lines 16, 17, 18, 19). The output signals are 3.3 V TTL signals which can be used to differentiate between up to 255 independent analyzer states. `CONTrol:AUXiliary:C[:DATA]` itself does not change the analyzer state.

**Channel bit definition and activation**

The channel bits have the following properties:

- After a \*RST of the analyzer all channel bits (including the value for the active, sweeping channel no. 1) are set to zero; no signal is applied to pins 8 to 11 and 16 to 19 of the Aux. Port connector.
- The value defined with `CONTrol:AUXiliary:C[:DATA]` is assigned to the **active** channel (`INSTrument:NSElect <Ch>`).
- The signals at the Aux. Port connector reflect the channel bits of the **measuring** channel, i.e. the channel for which the analyzer performs a sweep. This channel is not necessarily identical with the active channel.
- The signals are switched on as soon as a measurement (sweep) in a channel with non-zero channel bits is started. They are changed whenever a channel with different channel bits becomes the measuring channel.

- The signals at the Aux. Port connector are maintained after the analyzer enters the hold state. This happens if all channels use single sweep mode and if all sweep sequences have been terminated.
- Pins 16 to 19 may be reserved for monitoring the drive ports 1 to 4 of the analyzer (`OUTPut:UPORt:ECBits OFF`). This leaves up to 16 different monitored channel states.

**Tip:** A simple application consists of selecting the channel numbers as parameters for `CONTRol:AUXiliary:C[:DATA]` and monitor the activity of up to 255 different channels at the Aux. Port connector; see example below. You can also use the Aux. Port output signals as channel-dependent trigger signals for external devices. Use `OUTPut<Ch>:UPORt[:VALue]` to transfer the eight bit value for an arbitrary channel <Ch> in binary representation.

**Parameters:**

<DecValue>            Decimal value. The values correspond to the following states of the Aux. Port connector:  
 0 - no signal at any of the no signal at any of the eight pins 8, 9, 10, 11, 16, 17, 18, 19  
 1 - output signal at pin 8  
 2 - output signal at pin 9  
 3 - output signal at pins 8 and 9  
 ...  
 255 - output signal at pins 8, 9, 10, 11, 16, 17, 18, 19  
 Range:            0 to 255  
 \*RST:            0 (no signal)

**Example:**

```
*RST; :CONT:AUX:C 1
```

Assign the channel bit value 1 to the active channel no. 1. The analyzer performs a measurement in channel no. 1, therefore the output signal at pin 8 is switched on.

```
CONF:CHAN2:STAT ON; :CONT:AUX:C 2
```

Create channel no. 2, causing it to become the active channel, and assign the channel bit value 2. The analyzer performs no measurement in channel no. 2, therefore the output signal is not changed.

```
CALC2:PAR:SDEF 'Ch2Tr1', 'S11'
```

Create a trace named 'Ch2Tr1' and assign it to channel 2. While the analyzer measures in channel 2, the output signal changes from pin 8 to pin 9.

**Manual operation:** See "[Optional Columns](#)" on page 321

#### 11.5.2.4 DIAGnostic Commands

The `DIAGnostic...` commands provide access to service and diagnostic routines used in service, maintenance and repair. In accordance with the SCPI standard, all commands are device-specific.

|                                               |     |
|-----------------------------------------------|-----|
| <code>DIAGnostic:DUMP:SIZE</code> .....       | 757 |
| <code>DIAGnostic:SERVice:RFPower</code> ..... | 757 |

**DIAGnostic:DUMP:SIZE** <DumpSize>

Determines the level of detail and hence the size of the dump files created in case of firmware exceptions.

**Parameters:**

<DumpSize> NONE | MINI | NORMAl | LARGe | FULL  
 Either disables dump file creation (NONE) or determines the level of detail.

**DIAGnostic:SERVice:RFPower** <Boolean>

Turns the internal source power at all ports on or off. This command is equivalent to [OUTPut<Ch>\[:STATe\]](#) .

**Parameters:**

<Boolean> ON | OFF - switch the power on or off.  
 \*RST: ON

**Example:**

DIAG:SERV:RFP OFF  
 Turn off the RF source power.

**11.5.2.5 DISPlay Commands**

The [DISPlay...](#) commands control the selection and presentation of graphical and trace information on the screen.

**Trace display**

Traces are identified by a string parameter defining the trace name (e.g. [CALCulate<Ch>:PARAmeter:SElect](#) <TraceName>). In the [DISPlay...](#) subsystem, traces are assigned to diagrams ([DISPlay\[:WINDow<Wnd>\]:TRACe<WndTr>:FEED](#) <TraceName>). While this assignment is valid, the trace is identified by the numeric suffix <Wnd>, and the trace name is not needed.

**Units for DISPlay... commands**

The [DISPlay...](#) subsystem contains commands to define particular points in the diagram, e.g. to set the scale or a reference value. Some settings require a numeric value and a physical unit, depending on the related parameter type. The following table lists the physical units accepted by the analyzer.

| Parameter type | Physical unit                      |
|----------------|------------------------------------|
| Power          | DBM, DB, DBW, W, MW, UW, NW, PW    |
| Voltage        | V, MV, UV, NV, PV, DBV, DBMV, DBUV |
| Phase          | DEG, KDEG, MDEG, UDEG, NDEG, PDEG  |
| Group delay    | S, MS, US, NS, PS                  |
| Impedance      | OHM, GOHM, MOHM, KOHM              |

| Parameter type | Physical unit                           |
|----------------|-----------------------------------------|
| Admittance     | SIE, MSIE, USIE, NSIE                   |
| Inductance     | H, MH, UH, NH, PH, FH                   |
| Capacitance    | F, MF, UF, NF, PF, FF                   |
| Dimensionless  | UNIT, MUNIT, UUNIT, NUNIT, PUNIT, FUNIT |

|                                                             |     |
|-------------------------------------------------------------|-----|
| DISPlay:WINDow[:STATe].....                                 | 759 |
| DISPlay:WINDow:BFILter[:STATe].....                         | 759 |
| DISPlay:WINDow:MARKer<Mk>[:STATe].....                      | 759 |
| DISPlay[:WINDow<Wnd>]:[:STATe].....                         | 759 |
| DISPlay[:WINDow<Wnd>]:CATalog?.....                         | 760 |
| DISPlay[:WINDow<Wnd>]:MAXimize.....                         | 760 |
| DISPlay[:WINDow<Wnd>]:OVERview[:STATe].....                 | 761 |
| DISPlay[:WINDow<Wnd>]:NAME.....                             | 761 |
| DISPlay[:WINDow<Wnd>]:TITLe[:STATe].....                    | 762 |
| DISPlay[:WINDow<Wnd>]:TITLe:DATA.....                       | 762 |
| DISPlay[:WINDow<Wnd>]:TRACe<WndTr>:CATalog?.....            | 762 |
| DISPlay[:WINDow<Wnd>]:TRACe<WndTr>:DELeTe.....              | 763 |
| DISPlay[:WINDow<Wnd>]:TRACe<WndTr>:EFEed.....               | 763 |
| DISPlay[:WINDow<Wnd>]:TRACe<WndTr>:FEED.....                | 764 |
| DISPlay[:WINDow<Wnd>]:TRACe<WndTr>:LABel:SHOW.....          | 764 |
| DISPlay[:WINDow<Wnd>]:TRACe<WndTr>:SHOW.....                | 765 |
| DISPlay[:WINDow<Wnd>]:TRACe<WndTr>:X:OFFSet.....            | 766 |
| DISPlay[:WINDow<Wnd>]:TRACe<WndTr>:Y[:SCALE]:AUTO.....      | 766 |
| DISPlay[:WINDow<Wnd>]:TRACe<WndTr>:Y[:SCALE]:BOTTom.....    | 767 |
| DISPlay[:WINDow<Wnd>]:TRACe<WndTr>:Y[:SCALE]:TOP.....       | 767 |
| DISPlay[:WINDow<Wnd>]:TRACe<WndTr>:Y[:SCALE]:PDIVision..... | 768 |
| DISPlay[:WINDow<Wnd>]:TRACe<WndTr>:Y[:SCALE]:RLEVel.....    | 769 |
| DISPlay[:WINDow<Wnd>]:TRACe<WndTr>:Y[:SCALE]:RPOSition..... | 770 |
| DISPlay[:WINDow<Wnd>]:TRACe<WndTr>:Y:OFFSet.....            | 771 |
| DISPlay[:WINDow<Wnd>]:TRACe<WndTr>:ZOOM[:STATe].....        | 772 |
| DISPlay[:WINDow<Wnd>]:TRACe<WndTr>:ZOOM:START.....          | 773 |
| DISPlay[:WINDow<Wnd>]:TRACe<WndTr>:ZOOM:STOP.....           | 773 |
| DISPlay[:WINDow<Wnd>]:TRACe<WndTr>:ZOOM:BOTTom.....         | 773 |
| DISPlay[:WINDow<Wnd>]:TRACe<WndTr>:ZOOM:TOP.....            | 773 |
| DISPlay:ANNOtation:CHANnel[:STATe].....                     | 774 |
| DISPlay:ANNOtation:TRACe[:STATe].....                       | 774 |
| DISPlay:ANNOtation:FREQuency[:STATe].....                   | 774 |
| DISPlay:LAYout.....                                         | 774 |
| DISPlay:LAYout:APPLY.....                                   | 775 |
| DISPlay:LAYout:DEFine.....                                  | 775 |
| DISPlay:LAYout:EXECute.....                                 | 776 |
| DISPlay:LAYout:GRID.....                                    | 777 |
| DISPlay:LAYout:JOIN.....                                    | 777 |
| DISPlay:RFSize.....                                         | 777 |

---

**DISPlay:IWINDow[:STATe]** <Boolean>

Shows/hides the [Info Window](#)

**Parameters:**

<Boolean>                    0 – hide the "Info Window" (default)  
                                   1 – show the "Info Window"

**Manual operation:**    See "[Info Window](#)" on page 409

---

**DISPlay:IWINDow:BFILTer[:STATe]** <TraceName>, <BandfilterItem>, <Boolean>

Defines the bandfilter search results to be displayed in the [Info Window](#).

**Parameters:**

<Boolean>                    0 – Result <BandfilterItem> of trace <TraceName> is displayed  
                                   1 – Result <BandfilterItem> of trace <TraceName> is hidden

**Setting parameters:**

<TraceName>                Name of the related trace.

<BandfilterItem>          CENTER | BANDwidth | UPPer | LOWer | LOSS | QFACTOR |  
                                   QFA3 | HEADer  
                                   Bandfilter search result (see [Display Elements of a VNA Dia-  
 gram](#))

**Manual operation:**    See "[Content Selection](#)" on page 410

---

**DISPlay:IWINDow:MARKer<Mk>[:STATe]** <TraceName>, <Boolean>

Defines the markers to be displayed in the [Info Window](#).

**Suffix:**

<Mk>                         Marker number.

**Parameters:**

<Boolean>                    0 – Marker <Mk> of trace <TraceName> is displayed  
                                   1 – Marker <Mk> of trace <TraceName> is hidden

**Setting parameters:**

<TraceName>                Name of the related trace.

**Manual operation:**    See "[Content Selection](#)" on page 410

---

**DISPlay[:WINDow<Wnd>][:STATe]** <Boolean>

Creates or deletes a diagram area, identified by its area number <Wnd>.

**Suffix:**

<Wnd>                        Number of the diagram area to be created or deleted.

**Parameters:**

<Boolean>                    ON | OFF - creates or deletes diagram area no. <Wnd>.  
                                   \*RST:                    -

**Example:**            `CALC4:PAR:SDEF 'Ch4Tr1', 'S11'`  
 Create channel 4 and a trace named Ch4Tr1 to measure the input reflection coefficient  $S_{11}$ .  
`DISP:WIND2:STAT ON`  
 Create diagram area no. 2.  
`DISP:WIND2:TRAC9:FEED 'CH4TR1'`  
 Display the generated trace in diagram area no. 2, assigning the trace number 9 to it.

**Manual operation:** See ["Add Trace + Diagram"](#) on page 332

### DISPlay[:WINDow<Wnd>]:CATalog?

Returns the numbers and names of all diagrams in the current channel setup.

The response is a string containing a comma-separated list of diagram area numbers and names, see example below. If all diagram areas have been deleted, the response is an empty string ("").

**Suffix:**

<Wnd>                    Number of a diagram. This suffix is ignored; the command returns a list of all diagrams.

**Example:**            `*RST; :DISP:WIND2:STAT ON`  
 Create diagram no. 2.  
`DISP:WIND2:NAME 'S11 Test Diagram'`  
 Assign a name to the new diagram.  
`DISP:CAT?`  
 Query all diagrams and their names. As a default diagram no. 1 is created upon \*RST, the response is `'1,1,2,S11 Test Diagram'`. The first diagram is not named; its default name is equal to the diagram number.  
`CALC:PAR:SDEF 'Win2_Tr1', 'S11'`  
 Create a trace named Win2\_Tr1 to measure the input reflection coefficient  $S_{11}$ .  
`DISP:WIND2:TRAC9:FEED 'Win2_Tr1'`  
 Display the generated trace in diagram area no. 2, assigning the trace number 9 to it.  
`DISP:WIND2:TRAC:CAT?`  
 Query all traces in diagram area no. 2. The response is `'9,Win2_Tr1'`.

**Usage:**                Query only

**Manual operation:** See ["Title"](#) on page 403

### DISPlay[:WINDow<Wnd>]:MAXimize <Boolean>

Maximizes all diagram areas in the active channel setup or restores the previous display configuration.



**Suffix:**  
<Wnd> Number of the diagram area to become the active diagram area. `DISPlay:WINDow<Wnd>:MAXimize` acts on all diagrams of the current channel setup, however, the diagram no. <Wnd> is displayed on top of the others.

**Parameters:**  
<Boolean> ON | OFF - maximize all diagram areas or restore the previous display configuration.  
\*RST: OFF

**Example:** \*RST; :DISP:WIND2:STAT ON  
Create diagram areas no. 1 (with default trace) and 2 (with no trace).  
`DISP:WIND2:MAXimize ON`  
Maximize the diagram areas, placing area no. 2 on top.

**Manual operation:** See "[Maximize Diagram](#)" on page 403

#### **DISPlay[:WINDow<Wnd>]:OVERview[:STATe] <Boolean>**

Enables the zoom function with an additional overview window for the diagram no. <Wnd> or removes the overview window from a diagram.

**Suffix:**  
<Wnd> Number of the zoomed diagram area

**Parameters:**  
<Boolean> ON – activate the zoom window with overview window  
OFF – remove the overview window  
\*RST: OFF

**Example:** See `DISPlay[:WINDow<Wnd>]:TRACe<WndTr>:ZOOM[:STATe]`

#### **DISPlay[:WINDow<Wnd>]:NAME <Name>**

Defines a name for diagram area <Wnd>. The name appears in the list of diagram areas, to be queried by `DISPlay[:WINDow<Wnd>]:CATalog?`.

**Suffix:**  
<Wnd> Number of the diagram area.

**Parameters:**  
<Name> String variable for the name.

**Example:** See `DISPlay[:WINDow<Wnd>]:CATalog?`

**Manual operation:** See "[Title](#)" on page 403

**DISPlay[:WINDow<Wnd>]:TITLe[:STATe] <Boolean>**

Displays or hides the title for area number <Wnd>, defined by means of  
DISPlay:WINDow<Wnd>:TITLe:DATA.

**Suffix:**

<Wnd>                      Number of the diagram area.

**Parameters:**

<Boolean>                ON | OFF - displays or hides the title.  
\*RST:                    ON

**Example:**                See [DISPlay\[:WINDow<Wnd>\]:TITLe:DATA](#)

**Manual operation:**    See "[Show Title](#)" on page 404

**DISPlay[:WINDow<Wnd>]:TITLe:DATA <Title>**

Defines a title for diagram area <Wnd>.

**Suffix:**

<Wnd>                      Number of the diagram area.

**Parameters:**

<Title>                    String variable for the title. The length of the title is practically unlimited but should be kept short enough to be displayed in the diagrams.

**Example:**                \*RST; :DISP:WIND:TITL:DATA 'S21 Test Diagram'  
Define a title for the default diagram area. The title is displayed below the top of the diagram area.  
DISP:WIND:TITL OFF; TITL:DATA?  
Hide the title. The title is no longer displayed but still defined so it can be displayed again.

**Manual operation:**    See "[Title](#)" on page 403

**DISPlay[:WINDow<Wnd>]:TRACe<WndTr>:CATalog?**

Returns the numbers and names of all traces in diagram area no. <Wnd>.

**Suffix:**

<Wnd>                      Number of a diagram area.

<WndTr>                   Trace number used to distinguish the traces of the same diagram area <Wnd>. This suffix is ignored; the command returns a list of all traces.

**Example:**                See [DISPlay\[:WINDow<Wnd>\]:CATalog?](#)

**Usage:**                    Query only

**Manual operation:**    See "[Active Diagram](#)" on page 402

**DISPlay[:WINDow<Wnd>]:TRACe<WndTr>:DELeTe**

Releases the assignment between a trace and a diagram area, as defined by means of `DISPlay[:WINDow<Wnd>]:TRACe<WndTr>:FEED <TraceName>` and expressed by the `<WndTr>` suffix. The trace itself is not deleted; this must be done via `CALCulate<Ch>:PARAmeter:DELeTe <TraceName>`.

**Suffix:**

`<Wnd>` Number of an existing diagram area (defined by means of `DISPlay[:WINDow<Wnd>][:STATE] ON`).

`<WndTr>` Trace number used to distinguish the traces of the same diagram area `<Wnd>`.

**Example:**

```
CALC4:PAR:SDEF 'Ch4Tr1', 'S11'
Create channel 4 and a trace named Ch4Tr1 to measure the
input reflection coefficient S11.
DISP:WIND2:STAT ON
Create diagram area no. 2.
DISP:WIND2:TRAC9:FEED 'CH4TR1'
Display the generated trace in diagram area no. 2, assigning the
trace number 9 to it.
DISP:WIND2:TRAC9:DELeTe
Release the assignment between trace no. 9 and window no. 2.
The trace can still be referenced with its trace name Ch4Tr1.
```

**Usage:** Event

**DISPlay[:WINDow<Wnd>]:TRACe<WndTr>:EFEEd <TraceName>**

Assigns an existing trace (`CALCulate<Ch>:PARAmeter:SDEFine <TraceName>`) to a diagram area `<Wnd>`, and displays the trace. Use `DISPlay[:WINDow<Wnd>]:TRACe<WndTr>:FEED` to assign the trace to a diagram area using a numeric suffix (e.g. in order to use the `DISPlay[:WINDow<Wnd>]:TRACe<WndTr>:Y:OFFSet` command).

**Tip:** You can open the "Trace Manager" dialog to obtain an overview of all channels and traces, including the traces that are not displayed.

**Suffix:**

`<Wnd>` Number of an existing diagram area (defined by means of `DISPlay[:WINDow<Wnd>][:STATE] ON`).

`<WndTr>` Trace number. This suffix is ignored; the trace is referenced by its name.

**Setting parameters:**

`<TraceName>` String parameter for the trace name, e.g. 'Trc4'.

**Example:**            `CALC4:PAR:SDEF 'Ch4Tr1', 'S11'`  
 Create channel 4 and a trace named Ch4Tr1 to measure the input reflection coefficient  $S_{11}$ .  
`DISP:WIND2:STAT ON`  
 Create diagram area no. 2.  
`DISP:WIND2:TRAC:EFE 'CH4TR1'`  
 Display the generated trace in diagram area no. 2. No trace number is assigned.

**Usage:**            Setting only

---

### **DISPlay[:WINDow<Wnd>]:TRACe<WndTr>:FEED <TraceName>**

Assigns an existing trace (`CALCulate<Ch>:PARAmeter:SDEFine`) to a diagram area, using the `<WndTr>` suffix, and displays the trace. Use `DISPlay[:WINDow<Wnd>]:TRACe<WndTr>:EFEEd` to assign the trace to a diagram area without using a numeric suffix.

**Tip:** A trace can be assigned to a diagram only once. If a attempt is made to assign the same trace a second time (e.g. by typing `DISP:WIND2:TRAC8:FEED 'CH4TR1'` after executing the program example below) an error message -114,"Header suffix out of range" is generated. You can open the "Trace Manager" dialog to obtain an overview of all channels and traces, including the traces that are not displayed.

**Suffix:**

`<Wnd>`                Number of an existing diagram area (defined by means of `DISPlay[:WINDow<Wnd>][:STATe] ON`).

`<WndTr>`             Trace number used to distinguish the traces of the same diagram area `<Wnd>`.

**Parameters:**

`<TraceName>`        String parameter for the trace name, e.g. 'Trc4'.

**Example:**            `CALC4:PAR:SDEF 'Ch4Tr1', 'S11'`  
 Create channel 4 and a trace named Ch4Tr1 to measure the input reflection coefficient  $S_{11}$ .  
`DISP:WIND2:STAT ON`  
 Create diagram area no. 2.  
`DISP:WIND2:TRAC9:FEED 'CH4TR1'`  
 Display the generated trace in diagram area no. 2, assigning the trace number 9 to it.

**Manual operation:** See "Add Trace" on page 331

---

### **DISPlay[:WINDow<Wnd>]:TRACe<WndTr>:LABel:SHOW <TraceName>[, <Boolean>]**

Displays or hides the label of an existing trace, identified by its `<TraceName>`.

**Suffix:**

`<Wnd>`                ignored

<WndTr> ignored

**Parameters:**

<TraceName> Trace name (string parameter), e.g. 'Trc4'

<Boolean> ON | OFF – display or hide the label of the related trace

**Example:**

```
*RST; :DISP:TRAC:LAB:SHOW? 'Trc1'
```

Reset the analyzer, creating the default trace 'Trc1'. The trace label is displayed; the query returns 1.

```
DISP:TRAC:LAB:SHOW 'Trc1', OFF
```

Hide the label of trace 'Trc1'.

**Manual operation:** See "[Table Area](#)" on page 333

**DISPlay[:WINDow<Wnd>]:TRACe<WndTr>:SHOW <TraceName>[, <Boolean>]**

Displays or hides an existing trace, identified by its trace name <Trace\_Name>, or a group of traces.

**Tip:** You can open the trace manager to obtain an overview of all channels and traces, including the traces that are not displayed.

**Suffix:**

<Wnd> Number of a diagram area. This suffix is ignored; the command affects traces in all diagram areas.

<WndTr> Trace number. This suffix is ignored; the trace is referenced by its name.

**Parameters:**

<TraceName> DALL – all data traces  
MALL – all memory traces  
<string> – single trace identified by its trace name (string parameter), e.g. 'Trc4'.

<Boolean> ON | OFF – display or hide traces.

**Example:**

```
*RST; :DISP:TRAC:SHOW? 'Trc1'
```

Reset the analyzer, creating the default trace 'Trc1'. The trace is displayed; the query returns 1.

```
CALC4:PAR:SDEF 'Ch4Tr1', 'S11'
```

Create channel 4 and a trace named Ch4Tr1 to measure the input reflection coefficient  $S_{11}$ .

```
DISP:WIND2:STAT ON; :DISP:WIND2:TRAC:FEED
'CH4TR1'
```

Create diagram area no. 2 and display the generated trace in the diagram area.

```
DISP:TRAC:SHOW DALL, OFF
```

Hide both traces in both diagrams.

```
DISP:TRAC:SHOW? DALL
```

Query whether all data traces are displayed. The response 0 means that at least one trace is hidden.

**Manual operation:** See "[Table Area](#)" on page 333

**DISPlay[:WINDow<Wnd>]:TRACe<WndTr>:X:OFFSet <StimulusOffset>**

Shifts the trace <WndTr> in horizontal direction, leaving the positions of all markers unchanged.

**Suffix:**

<Wnd> Number of an existing diagram area (defined by means of [DISPlay\[:WINDow<Wnd>\]\[:STATe\] ON](#)).

<WndTr> Existing trace number, assigned by means of [DISPlay\[:WINDow<Wnd>\]:TRACe<WndTr>:FEED](#).

**Parameters:**

<StimulusOffset> Stimulus offset value.  
The range and unit depends on the sweep type.  
Default unit: NN

**Example:**

```
*RST; :DISP:WIND:TRAC:X:OFFS 1MHZ; :DISP:WIND:
TRAC:Y:OFFS 10
Create the default trace and shift it horizontally by 1 MHz, verti-
cally by 10 dB.
```

**Manual operation:** See "[Stimulus](#)" on page 365

**DISPlay[:WINDow<Wnd>]:TRACe<WndTr>:Y[:SCALE]:AUTO <Activate>[, <TraceName>]**

Displays the entire trace in the diagram area, leaving an appropriate display margin. The trace can be referenced either by its number <WndTr> or by its name <TraceName>.

**Suffix:**

<Wnd> Number of an existing diagram area (defined by means of [DISPlay\[:WINDow<Wnd>\]\[:STATe\] ON](#)). This suffix is ignored if the optional <TraceName> parameter is used.

<WndTr> Existing trace number, assigned by means of [DISPlay\[:WINDow<Wnd>\]:TRACe<WndTr>:FEED](#). This suffix is ignored if the optional <TraceName> parameter is used.

**Setting parameters:**

<Activate> ONCE  
Activate the autoscale function.

<TraceName> Optional string parameter for the trace name, e.g. 'Trc4'. If this optional parameter is present, both numeric suffixes are ignored (trace names must be unique across different channels and windows).

**Example:** \*RST; DISP:WIND:TRAC:Y:PDIV?; RLEV?  
 Query the value between two grid lines and the reference value for the default trace. The response is 10;0.  
 DISP:WIND:TRAC:Y:AUTO ONCE; PDIV?; RLEV?  
 or:  
 DISP:WIND:TRAC:Y:AUTO ONCE, 'Trc1'; PDIV?;  
 RLEV?  
 Autoscale the default trace and query the scaling parameters again. In general both values have changed.

**Usage:** Setting only

**Manual operation:** See "[Auto Scale Trace](#)" on page 302

**DISPlay[:WINDow<Wnd>]:TRACe<WndTr>:Y[:SCALE]:BOTTom** <LowEdge>[, <TraceName>]

**DISPlay[:WINDow<Wnd>]:TRACe<WndTr>:Y[:SCALE]:TOP** <UppEdge>[, <TraceName>]

These commands define the lower (bottom) and upper (top) edge of the diagram area <Wnd>.

**Suffix:**

<Wnd> Number of an existing diagram area (defined by means of [DISPlay\[:WINDow<Wnd>\]\[:STATE\] ON](#)). This suffix is ignored if the optional <TraceName> parameter is used.

<WndTr> Existing trace number, assigned by means of [DISPlay\[:WINDow<Wnd>\]:TRACe<WndTr>:FEED](#). This suffix is ignored if the optional <TraceName> parameter is used.

**Parameters:**

<UppEdge> Value and unit for the lower or upper diagram edge. Range and unit depend on the measured quantity, see "[Units for DISPlay... commands](#)" on page 757.

Default unit: NN

<TraceName> Optional string parameter for the trace name, e.g. 'Trc4'. If this optional parameter is present, both numeric suffixes are ignored (trace names must be unique across different channels and windows).

**Example:**

```
CALC4:PAR:SDEF 'Ch4Tr1', 'S11'
```

Create channel 4 and a trace named Ch4Tr1 to measure the input reflection coefficient  $S_{11}$ .

```
DISP:WIND2:STAT ON
```

Create diagram area no. 2.

```
DISP:WIND2:TRAC9:FEED 'CH4TR1'
```

Display the generated trace in diagram area no. 2, assigning the trace number 9 to it.

```
DISP:WIND2:TRAC9:Y:BOTT -40; TOP 10
```

or:

```
DISP:WIND2:TRAC:Y:BOTT -40, 'CH4TR1'; TOP 10, 'CH4TR1'
```

Scale the diagram between -40 dB and +10 dB.

**Manual operation:** See "[Max / Min](#)" on page 303

---

**DISPlay[:WINDow<Wnd>]:TRACe<WndTr>:Y[:SCALE]:PDIVision <VerticalDiv>[, <TraceName>]**

Sets the value between two grid lines (value "per division") for the diagram area <Wnd>. When a new PDIVision value is entered, the current RLEVel is kept the same, while the top and bottom scaling is adjusted for the new PDIVision value.

**Suffix:**

<Wnd>

Number of an existing diagram area (defined by means of [DISPlay\[:WINDow<Wnd>\]\[:STATE\] ON](#)). This suffix is ignored if the optional <TraceName> parameter is used.

<WndTr>

Existing trace number, assigned by means of [DISPlay\[:WINDow<Wnd>\]:TRACe<WndTr>:FEED](#). This suffix is ignored if the optional <TraceName> parameter is used.

**Parameters:**

<VerticalDiv>

Value and unit for the vertical diagram divisions. Range and unit depend on the measured quantity, see "[Units for DISPlay... commands](#)" on page 757.

Default unit: NN

<TraceName>

Optional string parameter for the trace name, e.g. 'Trc4'. If this optional parameter is present, both numeric suffixes are ignored (trace names must be unique across different channels and windows).



**Example:**

```
CALC4:PAR:SDEF 'Ch4Tr1', 'S11'
```

Create channel 4 and a trace named Ch4Tr1 to measure the input reflection coefficient  $S_{11}$ .

```
DISP:WIND2:STAT ON
```

Create diagram area no. 2.

```
DISP:WIND2:TRAC9:FEED 'CH4TR1'
```

Display the generated trace in diagram area no. 2, assigning the trace number 9 to it.

```
DISP:WIND2:TRAC9:Y:PDIV 5
```

or:

```
DISP:WIND2:TRAC:Y:PDIV 5, 'CH4TR1'
```

Set the value per division to 5 dB.

**Manual operation:** See ["Scale/Div"](#) on page 302

---

```
DISPlay[:WINDow<Wnd>]:TRACe<WndTr>:Y[:SCALE]:RLEVel <RefLevel>[,
<TraceName>]
```

Sets the reference level (or reference value) for a particular displayed trace. Setting a new reference level does not affect the value of `PDIVision`. The trace can be referenced either by its number `<WndTr>` or by its name `<TraceName>`.

**Suffix:**

`<Wnd>`

Number of an existing diagram area (defined by means of `DISPlay[:WINDow<Wnd>][:STATE] ON`). This suffix is ignored if the optional `<TraceName>` parameter is used.

`<WndTr>`

Existing trace number, assigned by means of `DISPlay[:WINDow<Wnd>]:TRACe<WndTr>:FEED`. This suffix is ignored if the optional `<TraceName>` parameter is used.

**Parameters:**

`<RefLevel>`

Value and unit for the reference level (or reference value, if the trace does not show a level). Range and unit depend on the measured quantity, see ["Units for DISPlay... commands"](#) on page 757.

Default unit: NN

`<TraceName>`

Optional string parameter for the trace name, e.g. 'Trc4'. If this optional parameter is present, both numeric suffixes are ignored (trace names must be unique across different channels and windows).

**Example:**

```
CALC4:PAR:SDEF 'Ch4Tr1', 'S11'
```

Create channel 4 and a trace named Ch4Tr1 to measure the input reflection coefficient  $S_{11}$ .

```
DISP:WIND2:STAT ON
```

Create diagram area no. 2.

```
DISP:WIND2:TRAC9:FEED 'CH4TR1'
```

Display the generated trace in diagram area no. 2, assigning the trace number 9 to it.

```
DISP:WIND2:TRAC9:Y:RLEV -10
```

or:

```
DISP:WIND2:TRAC:Y:RLEV -10, 'CH4TR1'
```

Change the reference level to -10 dB.

**Manual operation:** See ["Ref Value"](#) on page 303

---

```
DISPlay[:WINDow<Wnd>]:TRACe<WndTr>:Y[:SCALe]:RPOSition <RefPosition>[,
<TraceName>]
```

Sets the point on the y-axis to be used as the reference position as a percentage of the length of the y-axis. The reference position is the point on the y-axis which should equal the `RLEVEL`.

**Suffix:**

<Wnd>

Number of an existing diagram area (defined by means of `DISPlay[:WINDow<Wnd>][:STATe] ON`). This suffix is ignored if the optional <TraceName> parameter is used.

<WndTr>

Existing trace number, assigned by means of `DISPlay[:WINDow<Wnd>]:TRACe<WndTr>:FEED`. This suffix is ignored if the optional <TraceName> parameter is used.

**Parameters:**

<RefPosition>

Value of the reference position in percent. The top of the y-axis is defined to have a reference position of 100%, while the bottom of the y-axis is defined to have a reference position of 0%.

Range: 0% to 100%

\*RST: 80%

Default unit: %

<TraceName>

Optional string parameter for the trace name, e.g. 'Trc4'. If this optional parameter is present, both numeric suffixes are ignored (trace names must be unique across different channels and windows).

**Example:**

```
CALC4:PAR:SDEF 'Ch4Tr1', 'S11'
```

Create channel 4 and a trace named Ch4Tr1 to measure the input reflection coefficient  $S_{11}$ .

```
DISP:WIND2:STAT ON
```

Create diagram area no. 2.

```
DISP:WIND2:TRAC9:FEED 'CH4TR1'
```

Display the generated trace in diagram area no. 2, assigning the trace number 9 to it.

```
DISP:WIND2:TRAC9:Y:RPOS 50
```

or:

```
DISP:WIND2:TRAC:Y:RPOS 50, 'CH4TR1'
```

Set the reference position to the center of the diagram area.

**Manual operation:** See "[Ref Pos](#)" on page 303

**DISPlay[:WINDow<Wnd>]:TRACe<WndTr>:Y:OFFSet <MagnitudeFactor>[, <PhaseFactor>[, <RealPart>[, <ImaginaryPart>]]]**

Modifies all points of the trace <WndTr> by means of an added and/or a multiplied complex constant. The response values M of the trace are transformed according to:

**Suffix:**

<Wnd> Number of an existing diagram area (defined by means of [DISPlay\[:WINDow<Wnd>\]\[:STATe\] ON](#)).

<WndTr> Existing trace number, assigned by means of [DISPlay\[:WINDow<Wnd>\]:TRACe<WndTr>:FEED](#).

**Parameters:**

<MagnitudeFactor> Multiplied magnitude factor

Range: -300 dB to + 300 dB

\*RST: 0 dB

Default unit: dB

<PhaseFactor> Multiplied phase factor, optional for setting command but returned by query

Range:  $-3.4 \cdot 10^{38}$  deg to  $+3.4 \cdot 10^{38}$  deg

\*RST: 0 deg

Default unit: deg

<RealPart> Real and imaginary part of added complex constant, optional for setting command but returned by query

Range:  $-3.4 \cdot 10^{38}$  to  $+3.4 \cdot 10^{38}$

\*RST: 0

<ImaginaryPart>

- Example:** `*RST; :DISP:WIND:TRAC:X:OFFS 1MHZ; :DISP:WIND:TRAC:Y:OFFS 10`  
 Create the default trace and shift it horizontally by 1 MHz, vertically by 10 dB.  
`DISP:WIND:TRAC:Y:OFFS?`  
 Query all response offset values. The response is 10, 0, 0, 0.
- Manual operation:** See "[Mag / Phase / Real / Imag](#)" on page 366

**DISPlay[:WINDow<Wnd>]:TRACe<WndTr>:ZOOM[:STATe] <Boolean>[, <TraceName>]**

Applies or disables the zoom function based on the current zoom window settings.

**Suffix:**

<Wnd>

Number of an existing diagram (defined by means of [DISPlay\[:WINDow<Wnd>\]\[:STATe\] ON](#)). This suffix is ignored if the optional <TraceName> parameter is used.

<WndTr>

Existing trace number, assigned by means of [DISPlay\[:WINDow<Wnd>\]:TRACe<WndTr>:FEED](#). This suffix is ignored if the optional <TraceName> parameter is used.

**Parameters:**

<Boolean>

Enable or disable the zoom. OFF also restores the original diagram size after a zoom function was applied.  
 OFF

<TraceName>

Optional string parameter for the trace name, e.g. 'Trc4'. If this optional parameter is present, both numeric suffixes are ignored (trace names must be unique across different channels and windows).

**Example:**

`*RST; :DISPlay:WINDow1:TRACe:ZOOM:BOTTom -20; TOP +10; START 1GHz; STOP 1.5 GHz`

Define a zoom rectangle in the default diagram no. 1 ranging from -20 dB to +10 dB and from 1 GHz to 1.5 GHz.

`DISPlay:WINDow1:TRACe:ZOOM ON`

Zoom into the diagram no. 1 so that the zoom window fills the entire diagram. The actual sweep range and the stimulus values of the sweep points are not affected.

`DISPlay:WINDow1:OVERview:STATe ON`

Activate an additional overview window in the upper part of the diagram.

- Manual operation:** See "[Zoom Select/Stim. Zoom Select](#)" on page 305

---

```

DISPlay[:WINDow<Wnd>]:TRACe<WndTr>:ZOOM:START <LeftBorder>[,
 <TraceName>]
DISPlay[:WINDow<Wnd>]:TRACe<WndTr>:ZOOM:STOP <RightBorder>[,
 <TraceName>]

```

These commands specify the start and stop values of the zoom window (left and right border), respectively. In contrast to manual control, all or part of the zoom window may be outside the original diagram. The range of possible values depends on the R&S ZNL/ZNLE's frequency range; see "[SENSe:]FREQuency..." on page 875.

**Suffix:**

<Wnd>                      Number of an existing diagram (defined by means of [DISPlay\[:WINDow<Wnd>\]\[:STATe\] ON](#)). This suffix is ignored if the optional <TraceName> parameter is used.

<WndTr>                    Existing trace number, assigned by means of [DISPlay\[:WINDow<Wnd>\]:TRACe<WndTr>:FEED](#). This suffix is ignored if the optional <TraceName> parameter is used.

**Parameters:**

<RightBorder>            Left or right border of the zoom window.  
 Range:                    See description above.  
 \*RST:                    Start or stop of the analyzer's sweep range.  
 Default unit: NN

<TraceName>              Optional string parameter for the trace name, e.g. 'Trc4'. If this optional parameter is present, both numeric suffixes are ignored (trace names must be unique across different channels and windows).

**Example:**                See [DISPlay\[:WINDow<Wnd>\]:TRACe<WndTr>:ZOOM\[:STATe\]](#)

**Manual operation:**    See "Max / Min / Start / Stop" on page 306

---

```

DISPlay[:WINDow<Wnd>]:TRACe<WndTr>:ZOOM:BOTTom <LowEdge>[,
 <TraceName>]
DISPlay[:WINDow<Wnd>]:TRACe<WndTr>:ZOOM:TOP <UppEdge>[,
 <TraceName>]

```

These commands specify the lower and upper edge of the zoom window. In contrast to manual control, all or part of the zoom window may be outside the original diagram.

**Suffix:**

<Wnd>                      Number of an existing diagram (defined by means of [DISPlay\[:WINDow<Wnd>\]\[:STATe\] ON](#)). This suffix is ignored if the optional <TraceName> parameter is used.

<WndTr>                    Existing trace number, assigned by means of [DISPlay\[:WINDow<Wnd>\]:TRACe<WndTr>:FEED](#). This suffix is ignored if the optional <TraceName> parameter is used.

**Parameters:**

<UppEdge> Lower or upper edge of the zoom window. Range and unit depend on the measured quantity, see "[Units for DISPLAY... commands](#)" on page 757.

Default unit: NN

<TraceName> Optional string parameter for the trace name, e.g. 'Trc4'. If this optional parameter is present, both numeric suffixes are ignored (trace names must be unique across different channels and windows).

**Example:** See `DISPlay[:WINDow<Wnd>]:TRACe<WndTr>:ZOOM[:STATE]`

**Manual operation:** See "[Max / Min / Start / Stop](#)" on page 306

**DISPlay:ANNOtation:CHANnel[:STATe]** <Boolean>

**DISPlay:ANNOtation:TRACe[:STATe]** <Boolean>

Shows or hides the channel/trace list(s) in all diagrams of the current channel setup.

**Parameters:**

<Boolean> ON | OFF - show or hide information element(s).

\*RST: ON

**Example:** `*RST; :DISP:ANN:TRAC OFF; CHAN ON; FREQ OFF`  
Create diagram area no. 1 (with default trace) and hide the trace list. Keep the channel list but hide the swept frequency range.

**Manual operation:** See "[Trace Info](#)" on page 409

**DISPlay:ANNOtation:FREQUency[:STATe]** <Boolean>

Unmasks or masks all stimulus values in the VNA GUI for the active channel setup.

**Parameters:**

<Boolean> ON | OFF - unmask or mask stimulus values

\*RST: ON - all stimulus values unmasked

**Example:** `*RST; :DISP:ANN:FREQ OFF`  
Create diagram area no. 1 (with default trace) and mask all stimulus values.

**Manual operation:** See "[Hide Sensitive Information](#)" on page 408

**DISPlay:LAYout** <LayoutMode>

Arranges the diagrams in the screen, leaving the diagram contents unchanged.

**Parameters:**

<LayoutMode> LINEup | STACK | HORizontal | VERTical | GRID

LINEup – the diagrams are arranged side by side.

STACK – the diagrams are arranged one on top of the other.

HORizontal – the diagrams are arranged in horizontal rows.

VERTical – the diagrams are arranged in vertical rows.

GRID – the diagrams are arranged as a rectangular matrix. The number of rows and columns is as defined with command

`DISPlay:LAYout:GRID`.

**Example:** See `DISPlay:LAYout:GRID`

**Manual operation:** See "Split Type" on page 406

#### `DISPlay:LAYout:APPLy` <LayoutId>

Selects a previously defined layout for display in the analyzer screen.

#### Parameters:

<LayoutId> Integer value 1, 2 ...  
Current number, as defined by `DISPlay:LAYout:DEFine`.

**Example:** See [Creating Diagrams](#)

**Manual operation:** See "Additional Functionality: SCPI Commands" on page 407

#### `DISPlay:LAYout:DEFine` <LayoutId>, <LayoutFormatMode>, <LayoutData>

#### `DISPlay:LAYout:DEFine?` <LayoutId>

Creates a horizontal or vertical display layout and provides it with an identifier (<LayoutId>).

Layouts are defined row by row (horizontal layouts) or column by column (vertical layouts).

- A horizontal layout consists of N rows, each of height  $h_i$  ( $i = 1$  to  $N$ ). The heights are defined in units relative to the total height of the screen, i.e. their sum  $h_1 + h_2 + \dots + h_N$  must be equal to 1.00.  
Each row contains a selectable number of diagrams with independent widths  $w_{ij}$  ( $j = 1, 2 \dots M(i)$ ). The sum of the widths in each row must also match the screen width, hence  $w_{i1} + w_{i2} + \dots + w_{iM(i)} = 1.00$  for all rows ( $i = 1$  to  $N$ ).  
The <LayoutData> string for horizontal layouts reads ' $h_1, w_{11}, w_{12} \dots w_{1M(1)}; h_2, w_{21}, w_{22} \dots w_{2M(2)}; \dots; h_N, w_{N1}, w_{N2} \dots w_{NM(N)}$ '.  
A semicolon separates different rows, a comma separates different diagram widths within a row.
- The definition of a vertical layout is analogous, however, the role of rows and columns is interchanged.

The query returns the layout data in an alternative, executable format. The executable format is also used by `DISPlay:LAYout:EXECute`.

Use `DISPlay:LAYout:JOIN` or `DISPlay:LAYout:EXECute` to create more complicated (nested) layouts.

**Note:** The maximum number of diagrams in a layout is 256.

**Parameters:**

<LayoutFormatMode>HORizontal | VERTical

Horizontal or vertical layout; see above.

<LayoutData>

String parameter defining the number of diagrams and their position (easy format); see above.

**Parameters for setting and query:**

<LayoutId>

Integer value 1, 2 ...

Current number, used by other `DISPlay:LAYout...` commands to reference the created layout.

**Example:**

See [Creating Diagrams](#)

**Manual operation:** See "[Additional Functionality: SCPI Commands](#)" on page 407

**DISPlay:LAYout:EXECute** <LayoutData>

Creates and displays a horizontal or vertical display layout. The query returns the layout data of the currently displayed layout (the last layout selected via `DISPlay:LAYout:APPLY`) in executable format.

The executable format is an extension of the easy format used by `DISPlay:LAYout:DEFine`.

- The <LayoutData> string consists of two parts: <LayoutData> = '(<StartFormat>,<RepeatFormat<sub>1</sub>>,<RepeatFormat<sub>2</sub>> ...)'. The <StartFormat> descriptor distinguishes between horizontal and vertical layouts and defines the number of rows or columns. A <RepeatFormat> descriptor follows for each row or column in the layout. The <RepeatFormat> descriptors can be nested in order to describe joined layouts; refer to [Creating Diagrams](#) for an easy example.
- For a horizontal layout with N rows, each of height  $h_i$  ( $i = 1 \dots N$ ) and filled with  $M(i)$  diagrams with independent widths  $w_{ij}$  ( $j = 1, 2 \dots M(i)$ ), the data string is composed as follows:  
 <StartFormat> = N,1,0.00,0.00  
 <RepeatFormat<sub>i</sub>> = (1,M(i),1.00, $h_i$ [ $w_{i1}$ ,1.00], [ $w_{i2}$ ,1.00] ... [ $w_{iM(i)}$ ,1.00])
- For a vertical layout with N columns, each of width  $w_i$  ( $i = 1 \dots N$ ) and filled with  $M(i)$  diagrams with independent heights  $h_{ij}$  ( $j = 1, 2 \dots M(i)$ ), the data string is composed as follows:  
 <StartFormat> = 1,N,0.00,0.00  
 <RepeatFormat<sub>i</sub>> = (M(i),1, $w_i$ ,1.00,[1.00, $h_{i1}$ ], [1.00, $h_{i2}$ ] ... [1.00, $h_{iM(i)}$ ])

**Note:** The maximum number of diagrams in a layout is 256.

**Parameters:**

<LayoutData>

String parameter defining the number of diagrams and their position (executable format); see above.

**Example:**

See [Creating Diagrams](#)

**Manual operation:** See "[Additional Functionality: SCPI Commands](#)" on page 407



**DISPlay:LAYout:GRID** <Rows>, <Columns>

Defines the number of rows and columns if `DISPlay:LAYout GRID` is set.

**Parameters:**

|           |                |
|-----------|----------------|
| <Rows>    | Range: 1 to 16 |
|           | *RST: 1        |
| <Columns> | Range: 1 to 16 |
|           | *RST: 1        |

**Example:**

```
DISPlay:LAYout GRID
```

Select the split type where the diagrams are arranged in rows and columns.

```
DISPlay:LAYout:GRID 2,2
```

Arrange 4 diagrams in two rows and two columns.

**Manual operation:** See "[Diagrams / Rows / Columns](#)" on page 407

**DISPlay:LAYout:JOIN** <MainLayoutId>, <DiagramNumber>, <SubLayoutId>

Creates a nested layout, inserting a sub-layout into one of the diagrams of a main layout. Main layout and sub-layout must be defined previously, preferably using `DISPlay:LAYout:DEFine`.

**Note:** The maximum number of joined levels within a layout is 16.

**Setting parameters:**

|                 |                                                                                                             |
|-----------------|-------------------------------------------------------------------------------------------------------------|
| <MainLayoutId>  | Integer value 1, 2 ...<br>Current number of main layout, as defined by <code>DISPlay:LAYout:DEFine</code> . |
| <DiagramNumber> | Integer value 1, 2 ...<br>Diagram number in the main layout                                                 |
| <SubLayoutId>   | Integer value 1, 2 ...<br>Current number of sub-layout, as defined by <code>DISPlay:LAYout:DEFine</code> .  |
|                 | *RST: n/a                                                                                                   |

**Example:** See [Creating Diagrams](#)

**Usage:** Setting only

**Manual operation:** See "[Additional Functionality: SCPI Commands](#)" on page 407

**DISPlay:RFSize** <RelFontSize>

Defines the size of the fonts in the diagram on a relative scale.

**Parameters:**

<RelFontSize>      Relative font size  
 Range:            80 % to 170 %  
 \*RST:            100 %  
 Default unit: percent

**Example:**

\*RST; :DISP:RFS 80

Use smaller fonts to gain more space for the traces in the diagram.

**Manual operation:** See "[Font Size](#)" on page 409

**11.5.2.6 FORMat Commands**

The `FORMAT . . .` commands select a data format for transferring numeric data (including arrays) from and to the analyzer.

[FORMat\[:DATA\]](#)..... 778

---

**FORMat[:DATA]** <TransferFormat>[, <Length>]

Selects the format for numeric data transferred to and from the analyzer.

**Note:** The format setting is only valid for commands and queries whose description states that the response is formatted as described by `FORMat [:DATA]`. In particular, it affects trace data transferred by means of the commands in the `TRACe: . . .` system.

**Parameters:**

<TransferFormat>    ASCII | REAL  
 ASCII - numeric data is transferred as ASCII bytes. The numbers are separated by commas as specified in IEEE 488.2.  
 REAL - Data is transferred in a definite length block as IEEE floating point numbers of the specified <Length>. See [Chapter 11.4.1, "Block Data Format"](#), on page 576.  
**Note:** If binary data is transferred to the analyzer, the receive terminator should be set to EOI (`SYSTEM:COMMunicate: GPIB[:SELF]:RTERminator EOI`) to avoid inadvertent interruption of the data transfer.

<Length>            The optional <Length> parameter is needed for REAL format only. It defines the length of the floating point numbers in bits. Valid values are 32 and 64.

\*RST:            ASCII. The default length of REAL data is 32 bits (single precision).

**Example:**

```
FORM REAL, 32
```

Select real data format.

```
SYST:COMM:GPIB:RTER EOI
```

Set the terminator to EOI.

(During a calibration) ... CORR:CDAT?

```
'REFLTRACK',1,0
```

Query a system error correction term. The data is transferred in a definite length block which can be written to a file; the analyzer displays the message "<no> bytes binary data received".

**11.5.2.7 INITiate Commands**

The `INITiate...` commands control the initiation of the trigger system and define the scope of the triggered measurement.

|                                                         |     |
|---------------------------------------------------------|-----|
| <code>INITiate[:IMMEDIATE]:ALL</code> .....             | 779 |
| <code>INITiate:CONTinuous:ALL</code> .....              | 779 |
| <code>INITiate&lt;Ch&gt;[:IMMEDIATE]:DUMMy</code> ..... | 780 |
| <code>INITiate&lt;Ch&gt;[:IMMEDIATE]:SCOPE</code> ..... | 780 |
| <code>INITiate&lt;Ch&gt;:CONTinuous</code> .....        | 781 |

**INITiate[:IMMEDIATE]:ALL**

Starts a new single sweep sequence in all channels. This command is available in single sweep mode only (`INITiate:CONTinuous:ALL OFF`). The data of the last sweep (or of previous sweeps, see [Retrieving the Results of Previous Sweeps](#)) can be read using `CALCulate<Chn>:DATA:NSweep:FIRSt? SDATa, <count>`.

This command is not supported in the "ZVR" or "ZVABT" compatibility modes.

**Note:** In contrast to all other commands of the VNA mode, the `INITiate<Ch>[:IMMEDIATE]...` commands have been implemented for overlapped execution.

**Example:** See `INITiate<Ch>:CONTinuous`

**Usage:** Event

**Manual operation:** See "[Restart Sweep](#)" on page 328

**INITiate:CONTinuous:ALL <Boolean>**

Qualifies whether the analyzer measures in single sweep or in continuous sweep mode.

This command is not supported in the "ZVR" or "ZVABT" compatibility modes.

**Parameters:**

<Boolean> ON - the analyzer measures continuously in all channel, repeating the current sweep. The query returns ON (1) if at least one channel is measured continuously.  
 OFF - the measurement is stopped after the number of sweeps defined via [SENSe<Ch>:]SWEep:COUNT. INITiate<Ch>[:IMMediate][:DUMMy] initiates a new measurement cycle.  
 \*RST: ON

**Example:** See INITiate<Ch>:CONTinuous

**Manual operation:** See "All Channels Continuous/All Channels on Hold" on page 328

**INITiate<Ch>[:IMMediate][:DUMMy]**

Starts a new single sweep sequence. This command is available in single sweep mode only (INITiate<Ch>:CONTinuous OFF). The data of the last sweep (or previous sweeps, see "Retrieving the Results of Previous Sweeps" on page 980) can be read using CALCulate<Chn>:DATA:NSWeep:FIRSt? SDATa, <count>.

**Note:** In contrast to all other commands of the VNA mode, the INITiate<Ch>[:IMMediate]... commands have been implemented for overlapped execution.

**Suffix:**

<Ch> Channel number. If the channel number does not exist the analyzer returns an error message. If the "ZVR" or "ZVABT" compatibility mode is active and INITiate<Ch>[:IMMediate]:SCOPE ALL is selected, this suffix is ignored.

**Example:** See INITiate<Ch>:CONTinuous

**Usage:** Event

**Manual operation:** See "Restart Sweep" on page 328

**INITiate<Ch>[:IMMediate]:SCOPE <Scope>**

Selects the scope of the single sweep sequence. The setting is applied in single sweep mode only (INITiate<Ch>:CONTinuous OFF).

**Suffix:**

<Ch> Channel number

**Parameters:**

<Scope> ALL | SINGLE  
 INITiate<Ch>[:IMMediate][:DUMMy] starts a single sweep in all channels or in the referenced channel <Ch> only.

**Example:** See INITiate<Ch>:CONTinuous

**Manual operation:** See "Sweep All Channels/Sweeps" on page 330

**INITiate<Ch>:CONTInuous <Boolean>**

Qualifies whether the analyzer measures in single sweep or in continuous sweep mode.

**Suffix:**

<Ch> Channel number.

**Parameters:**

<Boolean> ON - the analyzer measures continuously, repeating the current sweep.  
 OFF - the measurement is stopped after the number of sweeps defined via [SENSe<Ch>:]SWEep:COUNT. INITiate<Ch>[:IMMediate][:DUMMy] initiates a new measurement cycle.  
 \*RST: ON

**Example:**

```
*RST; :CALC2:PAR:SDEF 'TRC2','S11'
DISPlay:WINDow:TRACe2:FEED 'Trc2'
```

Reset the analyzer to create the default channel no. 1 and default trace. Create a second trace and display the trace. Both traces are measured continuously.

```
INIT1:CONT OFF
```

Activate single sweep mode for the first channel. The measurement in channel no. 1 is stopped after the current sweep. Channel no. 2 is still measured continuously.

```
INIT1
```

Activate a new (single) sweep in channel no. 1. Channel no. 2 is still measured continuously.

```
INIT:CONT:ALL OFF
```

Activate single sweep mode for all channels. The measurement in channel no. 2 is also stopped after the current sweep.

```
INIT:ALL
```

Re-start a single sweep in both channels.

**Example:**

Alternative settings using the R&S ZVAB compatibility mode:

```
*RST; :SYSTem:LANGuage 'ZVABT'
```

```
*RST; :INIT:CONT OFF
```

Activate single sweep mode for all channels (including channel no. 2 created later).

```
INIT:SCOP SING
```

State that a single sweep will be performed in the active channel.

```
CALC2:PAR:SDEF 'TRC2','S11'; :INIT2
```

Create channel no. 2 with a new trace and start a single sweep in channel no. 2. Start a single sweep in the second channel.

**Manual operation:** See "[Continuous / Single](#)" on page 327

### 11.5.2.8 INStRument Commands

The `INStRument...` commands select or query particular resources (SCPI: logical instruments) of the analyzer.

|                                            |     |
|--------------------------------------------|-----|
| <code>INStRument:NSElect</code> .....      | 782 |
| <code>INStRument:PORT:COUNT?</code> .....  | 782 |
| <code>INStRument:TPORt:COUNT?</code> ..... | 782 |

---

#### **INStRument:NSElect** <Channel>

Selects a channel as the active channel.

##### **Parameters:**

<Channel>                      Number of the channel to be activated. The channel must be created before using `CONFigure:CHANnel<Ch>[:STATe] ON`.

Range:                      1, 2, ...

\*RST:                         1

##### **Example:**

```
CONF:CHAN2:STAT ON; :INST:NSEL?
Create channel no. 2 and select it as the active channel. The query returns 2.
```

---

#### **INStRument:PORT:COUNT?**

Returns the number of test ports (Port 1, Port 2 ...) of the analyzer.

##### **Example:**

```
INST:PORT:COUN?
Return the number of ports of your analyzer.
```

##### **Usage:**

Query only

---

#### **INStRument:TPORt:COUNT?**

Returns the total number of test ports.

Because the R&S ZNL/ZNLE doesn't support switch matrices, this is always the same as the number of analyzer ports (see `INStRument:PORT:COUNT?`).

##### **Usage:**

Query only

### 11.5.2.9 LAYOut

---

#### **LAYout:CATalog[:WINDow]?**

Queries the name and index of all active windows. Implements the correspondent spectrum analysis command for VNA channel setups.

The result is a comma-separated list of window names and numbers:

```
'<Name of Window 1>',1,...,'<Name of Window n>',n
```

If the marker info table is active, it is returned at the last position (...,'Info',n).

**Example:**

```

HCOpy:DEST 'MME'
Prepare a hardcopy to a file.
MME:NAME 'C:\temp\hc_test.pdf'
Specify the target file path.
HCOpy:DEvice:LANGUage PDF
Select file type PDF.
HCOpy:CONT WIND
Print multiple windows.
LAYout:CATalog?
Returns name and id of the active diagram areas and the the
marker info table (if active).
Suppose the marker info table is active.
HCOpy:PAGE:WINDow1:STATE 'VNA','Info',0
Exclude the marker info table from output.
HCOpy:IMMediate1
Print to file.

```

**Usage:** Query only

#### 11.5.2.10 MMEMemory Commands

The `MMEMemory...` commands provide mass storage capabilities for the analyzer.

|                                                                                              |     |
|----------------------------------------------------------------------------------------------|-----|
| <a href="#">MMEMemory:AKAL:FACTory:CONVersion</a> .....                                      | 784 |
| <a href="#">MMEMemory:AKAL:USER:CONVersion</a> .....                                         | 784 |
| <a href="#">MMEMemory:CKIT:INFO?</a> .....                                                   | 785 |
| <a href="#">MMEMemory:DELeTe:CORRection</a> .....                                            | 785 |
| <a href="#">MMEMemory:LOAD:CABLe</a> .....                                                   | 786 |
| <a href="#">MMEMemory:LOAD:CKIT</a> .....                                                    | 786 |
| <a href="#">MMEMemory:LOAD:CKIT:SDATa</a> .....                                              | 787 |
| <a href="#">MMEMemory:LOAD:CKIT:SDATa:WLAbel</a> .....                                       | 788 |
| <a href="#">MMEMemory:LOAD:CKIT:UDIRectory</a> .....                                         | 789 |
| <a href="#">MMEMemory:LOAD:CORRection</a> .....                                              | 790 |
| <a href="#">MMEMemory:LOAD:CORRection:MERGe</a> .....                                        | 791 |
| <a href="#">MMEMemory:LOAD:CORRection:RESolve</a> .....                                      | 792 |
| <a href="#">MMEMemory:LOAD:LIMit</a> .....                                                   | 792 |
| <a href="#">MMEMemory:LOAD:RIPPLe</a> .....                                                  | 794 |
| <a href="#">MMEMemory:LOAD:SEGMENT</a> .....                                                 | 795 |
| <a href="#">MMEMemory:LOAD:TRACe</a> .....                                                   | 796 |
| <a href="#">MMEMemory:LOAD:TRACe:AUTO</a> .....                                              | 797 |
| <a href="#">MMEMemory:LOAD:VNETworks&lt;Ch&gt;:BALanced:DEEMbedding&lt;LogPt&gt;</a> .....   | 797 |
| <a href="#">MMEMemory:LOAD:VNETworks&lt;Ch&gt;:BALanced:EMBedding&lt;LogPt&gt;</a> .....     | 797 |
| <a href="#">MMEMemory:LOAD:VNETworks&lt;Ch&gt;:DIFFerential:EMBedding&lt;LogPt&gt;</a> ..... | 798 |
| <a href="#">MMEMemory:LOAD:VNETworks&lt;Ch&gt;:GLOop:DEEMbedding</a> .....                   | 799 |
| <a href="#">MMEMemory:LOAD:VNETworks&lt;Ch&gt;:GLOop:EMBedding</a> .....                     | 799 |
| <a href="#">MMEMemory:LOAD:VNETworks&lt;Ch&gt;:PPAir:DEEMbedding&lt;ListId&gt;</a> .....     | 799 |
| <a href="#">MMEMemory:LOAD:VNETworks&lt;Ch&gt;:PPAir:EMBedding&lt;ListId&gt;</a> .....       | 799 |
| <a href="#">MMEMemory:LOAD:VNETworks&lt;Ch&gt;:SENDEd:DEEMbedding&lt;PhyPt&gt;</a> .....     | 801 |
| <a href="#">MMEMemory:LOAD:VNETworks&lt;Ch&gt;:SENDEd:EMBedding&lt;PhyPt&gt;</a> .....       | 801 |
| <a href="#">MMEMemory:STORe:CABLe</a> .....                                                  | 802 |

|                                            |     |
|--------------------------------------------|-----|
| MMEMory:STORe:CKIT.....                    | 802 |
| MMEMory:STORe:CKIT:WLABEL.....             | 803 |
| MMEMory:STORe:CORRection.....              | 803 |
| MMEMory:STORe:LIMit.....                   | 803 |
| MMEMory:STORe:MARKer.....                  | 804 |
| MMEMory:STORe:RIPPlE.....                  | 804 |
| MMEMory:STORe:SEGMENT.....                 | 805 |
| MMEMory:STORe:TRACe.....                   | 805 |
| MMEMory:STORe:TRACe:CHANnel.....           | 806 |
| MMEMory:STORe:TRACe:OPTion:BALanced.....   | 808 |
| MMEMory:STORe:TRACe:OPTion:SYMMetric.....  | 808 |
| MMEMory:STORe:TRACe:OPTion:PLUS.....       | 808 |
| MMEMory:STORe:TRACe:OPTion:SSEParator..... | 808 |
| MMEMory:STORe:TRACe:OPTion:TABS.....       | 808 |
| MMEMory:STORe:TRACe:OPTion:TRIM.....       | 809 |
| MMEMory:STORe:TRACe:PORTs.....             | 809 |

---

### MMEMory:AKAL:FACTory:CONVersion <Directory>

Converts the factory calibration data of the standards in the active calibration unit (`SYSTem:COMMunicate:RDEvice:AKAL:ADDRESS`) to Touchstone format and copies it to the specified directory.

#### Setting parameters:

<Directory> String parameter to specify the directory.

#### Example:

```
MMEM:AKAL:FACTory:CONVersion 'C:\Users\Public\
Documents\Rohde-Schwarz\ZNL\AKAL\Touchstone'
```

Convert and copy the factory calibration data of the active calibration unit to the specified (writable) directory.

**Usage:** Setting only

**Manual operation:** See "Apply/Cancel" on page 460

---

### MMEMory:AKAL:USER:CONVersion <Directory>[, <CalKitFile>]

Converts an arbitrary (e.g. user-defined) set of calibration data of the standards in the active calibration unit (`SYSTem:COMMunicate:RDEvice:AKAL:ADDRESS`) to Touchstone format and copies it to the specified directory.

#### Setting parameters:

<Directory> String parameter to specify the directory.

<CalKitFile> Name and (possibly) directory of the cal kit file to be used for the automatic calibration (optional string parameter):

- If the parameter is omitted, the analyzer uses the last characterized cal kit file.
- If an empty string ( ' ' ) is specified, the factory cal kit file stored in the active calibration unit (`SYSTem:COMMunicate:RDEvice:AKAL:ADDRESS`) is used. By default this file is also used in manual control.



– A cal kit file name \*.calkit without path denotes a specific cal kit file stored in the active calibration unit.

– A cal kit file name \*.calkit with path denotes a specific cal kit file stored in an arbitrary directory.

**Example:**

```
MMEM:AKAL:USER:CONV 'C:\Users\Public\
Documents\Rohde-Schwarz\ZNL\AKAL\Touchstone'
Convert and copy the calibration data of the standards of the last
characterized cal kit to the specified (writable) directory.
```

```
MMEM:AKAL:USER:CONV 'C:\Users\Public\
Documents\Rohde-Schwarz\ZNL\AKAL\Touchstone',
'user.calkit'
```

Convert and copy the calibration data of the standards of the user-defined cal kit 'user.calkit' to the specified directory.

**Usage:** Setting only

**Manual operation:** See "[Apply/Cancel](#)" on page 460

**MMEMory:CKIT:INFO?** <CalKitFile>[, <Detail>]

Queries connector type, name, label and gender of a cal kit defined in the specified cal kit file

**Query parameters:**

<CalKitFile> Path to the cal kit file, either absolute or relative to the current directory (see [MMEMory:CDIRectory](#))

<Detail> CONNECTor | LABEL | NAME | GENDER  
If specified, the command only returns the corresponding property

**Return values:**

<ConnectorType>

<CalKitName>

<KitLabel>

<Gender> **1**: has a gender  
**0**: doesn't have a gender

**Usage:** Query only

**MMEMory:DELeTe:CORRection** <CalGroupName>

Deletes a system error correction data set stored in the cal pool (cal group file).

**Setting parameters:**

<CalGroupName> String parameter to specify the name of the cal group file to be deleted. Cal group files must have the extension \*.cal. The directory path must not be specified; the analyzer always uses the default cal pool directory  
 C:\Users\Public\Documents\Rohde-Schwarz\ZNL\Calibration\Data.

**Example:** See [MMEMory:LOAD:CORRection](#)

**Usage:** Setting only

**Manual operation:** See "[Pool / Delete from Pool](#)" on page 482

**MMEMory:LOAD:CABLe** <InputDir>

Loads Distance to Fault (DtF) cable type files (\*.rsc) from the specified input directory.

Cable types are loaded "by name", overwriting user-defined cable types of the same name. Predefined cable types of the same name will not be overwritten.

**Setting parameters:**

<InputDir> Input Directory

**Example:** `MMEMory:STORe:CABLe 'C:\dtf-cables'`  
 Saves all predefined and user-defined Distance to Fault (DtF) cable types to the directory C:\dtf-cables.  
 Edit \*.rsc files for user defined cable types, copy \*.rsc files, rename and edit them. Afterwards execute  
`MMEMory:LOAD:CABLe 'C:\dtf-cables'`  
 to update existing and create new user-defined cable types.

**Usage:** Setting only

**Options:** R&S ZNL-K3

**Manual operation:** See "[Add / Delete](#)" on page 357

**MMEMory:LOAD:CKIT** <CalKitFile>

Loads cal kit data from the specified cal kit file.

**Setting parameters:**

<CalKitFile> String parameter to specify name and directory of the loaded cal kit file. If no path is specified the analyzer searches the current directory, to be queried with [MMEMory:CDIRectory?](#)

**Example:**

```
MMEM:LOAD:CKIT 'C:\Users\Public\Documents
\Rohde-Schwarz\ZNL\Calibration\Kits\New_kit.calkit'
Load the previously created cal kit file New_kit.calkit from
the default cal kit directory.
... :MMEM:STOR:CKIT 'New_kit', 'C:
\Users\Public\Documents
\Rohde-Schwarz\ZNL\Calibration\Kits\New_kit.calkit'
Store the data for the user-defined cal kit Newkit and overwrite
the cal kit file New_kit.calkit.
```

**Usage:** Setting only

**Manual operation:** See "[Import Cal Kit...](#)" on page 464

**MMEMory:LOAD:CKIT:SDATa** <ConnectorType>, <CalKitName>, <StandardType>, <StandardLabel>, <TouchstoneFile>[, <FirstPort>[, <SecondPort>]]

Loads cal kit data for a calibration standard from a specified Touchstone file. A restriction on the port assignment may be defined in addition.

Use the newer command `MMEMory:LOAD:CKIT:SDATa:WLABel` to be able to distinguish cal kits by label.

**Setting parameters:**

|                  |                                                                                                                                                                                                                                                                                                                                                                                                                                                                                                                         |
|------------------|-------------------------------------------------------------------------------------------------------------------------------------------------------------------------------------------------------------------------------------------------------------------------------------------------------------------------------------------------------------------------------------------------------------------------------------------------------------------------------------------------------------------------|
| <ConnectorType>  | String parameter containing the name of the connector type.                                                                                                                                                                                                                                                                                                                                                                                                                                                             |
| <CalKitName>     | String parameter containing the name of a calibration kit available on the analyzer.                                                                                                                                                                                                                                                                                                                                                                                                                                    |
| <StandardType>   | MMTHrough   MFTHrough   FFTHrough   MMLine   MMLine1   MMLine2   MMLine3   MFLine   MFLine1   MFLine2   MFLine3   FFLine   FFLine1   FFLine2   FFLine3   MMATten   MFATten   FFATten   MMSNetwork   MFSNetwork   FFSNetwork   MOPen   FOPen   MSHort   FSHort   MOShort   MOShort1   MOShort2   MOShort3   FOSHort   FOSHort1   FOSHort2   FOSHort3   MREFlect   FREFlect   MMTCh   FMTCh   MSMATCH   FSMATCH<br>Standard types; for a description refer to table <a href="#">Standard types and their parameters</a> . |
| <StandardLabel>  | String parameter addressing a particular calibration standard by its label. An empty string means that no label is defined.                                                                                                                                                                                                                                                                                                                                                                                             |
| <TouchstoneFile> | String parameter to specify name and directory of the Touchstone file to be loaded. A *.s1p file must be used for one-port standards, a *.s2p file for two-port standards.<br>If no path is specified the analyzer searches the current directory, to be queried with <code>MMEMory:CDIRECTory?</code><br>*RST: -                                                                                                                                                                                                       |
| <FirstPort>      | First port number (sufficient for one-port standards). If the port numbers are omitted, the cal kit data is valid for all ports.                                                                                                                                                                                                                                                                                                                                                                                        |
| <SecondPort>     | Second port number, for two-port standards. If the port numbers are omitted, the cal kit data is valid for all ports.                                                                                                                                                                                                                                                                                                                                                                                                   |

**Example:** `MMEM:LOAD:CKIT:SDAT 'N 50 Ohm', 'Default Kit', MOPEN, 'Test data', 'test.s1p', 1`  
 Load the file Test.s1p from the current directory in order to define the properties of an Open (m) standard in the cal kit named "Default Kit" for the N 50 Ω connector type. Assign the label "Test data" and specify that the standard data is valid for port no. 1 only.

**Usage:** Setting only

**Manual operation:** See ["Read .s1p File... / Read .s2p File..."](#) on page 474

**Connector and cal kit naming conventions:**

Connector and calibration kit names must be entered as string parameters. The strings contain the connector and cal kit names used in the `Calibration Kits` dialog; a Ω in the name must be replaced by 'Ohm', e.g.:

- 'NewKit1' denotes the user-defined calibration kit "NewKit1".

- 'N 50 Ohm Ideal Kit' denotes the "N 50 Ω Ideal Kit".

- 'ZV-Z21 typical' denotes the cal kit "ZV-Z21 typical".

---

**MMEMory:LOAD:CKIT:SDATa:WLABel** <ConnectorType>, <CalKitName>, <KitLabel>, <StandardType>, <StandardLabel>, <TouchstoneFile>[, <FirstPort>[, <SecondPort>]]

Loads characterization data from the given Touchstone file; similar to existing command `MMEMory:LOAD:CKIT:SDATa` but supports cal kit addressing **by label**.

**Setting parameters:**

<ConnectorType> String parameter containing the name of the connector type.

<CalKitName> String parameter containing the name of a calibration kit available on the analyzer.

<KitLabel> String parameter containing the label of a calibration kit available on the analyzer. An empty string means that no label is defined.

<StandardType> MMTThrough | MFTThrough | FFTHrough | MMLine | MMLine1 | MMLine2 | MMLine3 | MFLine | MFLine1 | MFLine2 | MFLine3 | FFLine | FFLine1 | FFLine2 | FFLine3 | MMATten | MFATten | FFATten | MMSNetwork | MFSNetwork | FFSNetwork | MOPen | FOPen | MSHort | FSHort | MOShort | MOShort1 | MOShort2 | MOShort3 | FOSHort | FOSHort1 | FOSHort2 | FOSHort3 | MREFlect | FRElect | MMTCh | FMTCh | MSMatch | FSMatch  
 Standard types; for a description refer to table [Standard types and their parameters](#).

<StandardLabel> String parameter addressing a particular calibration standard by its label. An empty string means that no label is defined.

<TouchstoneFile> String parameter to specify the name and directory of the Touchstone file to be loaded. A \*.s1p file must be used for one-port standards, a \*.s2p file for two-port standards. If no path is specified the analyzer searches the current directory, to be queried with [MMEemory:CDIRectory?](#)

<FirstPort> First port number (sufficient for one-port standards). If the port numbers are omitted, the cal kit data is valid for all ports.

<SecondPort> Second port number, for two-port standards. If the port numbers are omitted, the cal kit data is valid for all ports.

**Example:**

```
MMEM:LOAD:CKIT:SDAT:WLAB 'N 50 Ohm','Default Kit','0815',MOPEN,'Test data','test.s1p',1
```

Load the file Test.s1p from the current directory in order to define the properties of an Open (m) standard in the cal kit "Default Kit" with label "0815" for the N 50 Ω connector type. Assign the label "Test data" and specify that the standard data is valid for port no. 1 only.

**Usage:** Setting only

**Connector and cal kit naming conventions:**

Connector and calibration kit names must be entered as string parameters. The strings contain the connector and cal kit names used in the *Calibration Kits* dialog; a Ω in the name must be replaced by 'Ohm', e.g.:

-'NewKit1' denotes the user-defined calibration kit "NewKit1".

-'N 50 Ohm Ideal Kit' denotes the "N 50 Ω Ideal Kit".

-'ZV-Z21 typical' denotes the cal kit "ZV-Z21 typical".

**MMEMory:LOAD:CKIT:UDIRectory <Directory>**

Specifies the "Search Path for Additional Cal Kits and Connector Types". All cal kit files in the specified directory will be (re-)loaded automatically as predefined kits (i.e. read-only kits which cannot be modified) every time the VNA application is started.

**Parameters:**

<Directory> String parameter to specify the directory path. The directory can be created separately ([MMEemory:MDIRectory](#)). An empty string means that no cal kit files will be loaded.

- Example:** MMEM:LOAD:CKIT:UDIR 'C:\Users\Public\Documents\Rohde-Schwarz\ZNL\Calibration\Kits\Autoload'  
Specify the directory for additionally available cal kits.  
MMEM:MDIR 'C:\Users\Public\Documents\Rohde-Schwarz\ZNL\Calibration\Kits\Autoload'  
Create the specified "Autoload" directory.  
MMEM:STOR:CKIT 'New Kit 1', 'C:\Users\Public\Documents\Rohde-Schwarz\ZNL\Calibration\Kits\Autoload\New Kit 1.calkit'  
Store the data for the existing, user-defined cal kit "New Kit 1" to the "Autoload" directory.
- Manual operation:** See ["Search Path for additional Cal Kits and Connector Types"](#) on page 143

---

### MMEMory:LOAD:CORRection <Channel>[, <CalGroupFile>]

Applies a system error correction data set stored in the cal pool (cal group file) to channel <Channel>.

#### Parameters:

- <Channel> Channel number of an existing channel. ALL applies the selected data set to all channels.
- <CalGroupFile> String parameter to specify the name of the cal group file to be loaded. Cal group files must have the extension \*.cal. The directory path must not be specified; the analyzer always uses the default cal pool directory C:\Users\Public\Documents\Rohde-Schwarz\ZNL\Calibration\Data.

- Example:** MMEM:STOR:CORR 1, 'Calgroup1.cal'  
Copy the current correction data set of channel 1 to a cal group file Calgroup1.cal.  
CONF:CHAN2:STAT ON; :MMEM:LOAD:CORR 2, 'Calgroup1.cal'  
Apply the stored correction data (cal group file) to channel 2.  
MMEM:LOAD:CORR? 2  
Query the cal group file for channel 2. Response: 'Calgroup1.cal'  
MMEM:LOAD:CORR:RES 2, 'Calgroup1.cal'  
Resolve the pool link between channel 2 and the cal group file.  
MMEM:LOAD:CORR? 2  
Query the cal group file for channel 2. Response: ''  
MMEM:DEL:CORR 'Calgroup1.cal'  
Delete the created cal group file.

- Manual operation:** See ["Add / Add All... / Replace / Apply / Apply to All"](#) on page 481

**MMEMory:LOAD:CORRection:MERGe** <Channel>[, <CalGroupFile>[, <CalGroupFile>]...]

Merges (activates) several cal group files for channel no. <Channel> so that the query [SENSe<Ch>:]CORRection:COLLect:METHod:DEFine? returns a list of all merged calibration types (equivalent to the calibration pool list in the "Calibration Manager" dialog). The merged cal group files can be stored to a common file (see example).

**Note** that the calibrations to be merged must be based on the same frequency grid (identical frequency sweep points).

**Setting parameters:**

<Channel> Channel number of an existing channel

<CalGroupFile>

<CalGroupFile> String parameters with the names of the merged cal group files. Cal group files must have the extension \*.cal. The file extensions must be specified as part of the string parameters. In contrast the directory path must not be specified; the analyzer always uses the default path

C:\Users\Public\Documents\Rohde-Schwarz\ZNL\CALibration\DATA.

**Example:**

SENS1:CORR:COLL:METH:DEF 'Test', FRTRans, 1, 3

Select a bidirectional transmission normalization between ports 1 and 3 as a calibration type for channel 1.

CORR:COLL:SAVE:SEL:DEF; :MMEM:STOR:CORR 1, 'P1-P3.cal'

Create a default calibration data set for the selected calibration type and store the data to a cal group file.

SENS1:CORR:COLL:METH:DEF 'Test', FRTRans, 1, 4

Select a bidirectional transmission normalization between ports 1 and 4 as a calibration type for channel 1.

CORR:COLL:SAVE:SEL:DEF; :MMEM:STOR:CORR 1, 'P1-P4.cal'

Create a default calibration data set for the selected calibration type and store the data to a cal group file.

CORR:COLL:METH:DEF?

Query the active calibrations for channel 1. The response is FRTR0104 (the last data set stored).

MMEM:LOAD:CORR:

MERGE 1, 'P1-P3.cal', 'P1-P4.cal'; :CORR:COLL:METH:DEF?

Merge the two calibration types and query the active calibrations again. The response is FRTR0103, FRTR0104.

MMEM:STOR:CORR 1, 'Merged.cal'

Store both sets of calibration data to a common cal group file.

**Usage:** Setting only

**Manual operation:** See ["Add / Add All... / Replace / Apply / Apply to All"](#) on page 481

---

### **MMEMory:LOAD:CORRection:RESolve** <Channel>[, <CalGroupFile>]

Resolves the pool link between channel <Channel> and a correction data set (cal group file). After resolving the pool link, the analyzer keeps the previous system error correction as a channel calibration ("Channel Cal"). A new calibration will replace the channel calibration but not overwrite the old cal group file (and not affect other channels).

#### **Setting parameters:**

<Channel> Channel number of an existing channel. ALL resolves the pool link for all channels.

<CalGroupFile> Optional string parameter to specify the name of the cal group file. Cal group files must have the extension \*.cal. The directory must not be specified; the analyzer always uses the default path C:\Users\Public\Documents\Rohde-Schwarz\ZNL\Calibration\Data. If there is no link between <Ch> and the specified file, the command has no effect. If no file is specified, the command resolves any link between <Ch> and an arbitrary cal group file.

**Example:** See [MMEMory:LOAD:CORRection](#)

**Usage:** Setting only

**Manual operation:** See ["Resolve Pool Link / Remove Pool Link"](#) on page 482

---

### **MMEMory:LOAD:LIMit** <TraceName>, <LimLineFile>[, <TouchstoneFile>[, <StimulusOffset>[, <ResponseOffset>[, <LimLineType>]]]]

Loads a limit line definition from a specified file and assigns it to a trace with a specified name. Limit lines are created using the CALCulate<Ch>:LIMit... commands.

**Note:** Limit lines can be loaded from Touchstone files (\*.s<n>p, where <n> denotes the number of ports). The optional parameters '<TouchstoneFile>', <StimulusOffset>, <ResponseOffset>, <LimLineType> are only relevant for Touchstone files. For \*.limit files, no optional parameters can be set.

#### **Setting parameters:**

<TraceName> Name of an existing trace in the active channel setup (string parameter). The imported limit line is assigned to this trace, irrespective of the trace information in the limit line file.

<LimLineFile> String parameter to specify the name and directory of the limit line file to be loaded. The default extension (manual control) for limit line files is \*.limit, although other extensions are allowed. If no path is specified the analyzer searches the current directory, to be queried with MMEMory:CDIRectory?. See also note on Touchstone files above.



|                  |                                                                                                                                                                                                                                                                               |
|------------------|-------------------------------------------------------------------------------------------------------------------------------------------------------------------------------------------------------------------------------------------------------------------------------|
| <TouchstoneFile> | <p>String parameter, selects an S-parameter from a Touchstone file. The parameter must be compatible with the file type (e.g. for one-port Touchstone files *.s1p, only the parameter name 'S11' is allowed).</p> <p>*RST: 'S11' (if all optional parameters are omitted)</p> |
| <StimulusOffset> | <p>Stimulus offset for limit lines loaded from a Touchstone file. A 1 GHz offset shifts the limit line by 1 GHz in (positive) horizontal direction.</p> <p>Range: Depending on the sweep range of the analyzer.</p> <p>*RST: 0</p> <p>Default unit: NN</p>                    |
| <ResponseOffset> | <p>Response offset for limit lines loaded from a Touchstone file. A 1 dB offset shifts the limit line by 1 dB in (positive) vertical direction.</p> <p>Range: Depending on the measured quantity.</p> <p>*RST: 0</p> <p>Default unit: NN</p>                                  |
| <LimLineType>    | <p>LMIN   LMAX   OFF</p> <p>Limit line type :</p> <p>LMAX - upper limit line</p> <p>LMIN - lower limit line</p> <p>OFF - limit line off</p> <p>*RST: LMAX (if all optional parameters are omitted)</p>                                                                        |

- Example:** Assume that the current channel setup contains two traces named Trc1 and Trc2, respectively, and that limit lines have been defined for Trc1.
- ```
MMEM:STOR:LIM 'TRC1', 'C:
\Users\Public\Documents
\Rohde-Schwarz\ZNL\LIMitLines\Lim_Trcl.limit'
```
- Store the limit line definition of Trc1 to a limit line file.
- ```
MMEM:LOAD:LIM 'TRC2', 'C:
\Users\Public\Documents
\Rohde-Schwarz\ZNL\LIMitLines\Lim_Trcl.limit'
```
- Load the previously created limit line file and assign the limit lines to Trc2.
- ```
MMEM:STOR:TRAC 'TRC1', 'C:
\Users\Public\Documents
\Rohde-Schwarz\ZNL\LIMitLines\Trcl.slp'
```
- Store the current trace data of Trc1 to a limit line file in Touchstone format.
- ```
MMEM:LOAD:LIM 'TRC1', 'C:
\Users\Public\Documents
\Rohde-Schwarz\ZNL\LIMitLines\Trcl.slp', 'S11',
0, 2, LMAX
```
- Load the previously created Touchstone limit line file and assign the limit lines to Trc1, applying a response offset of 2 dB.
- ```
CALC:LIMit:DISPlay ON
```
- Show the limit line in the diagram.
- Usage:** Setting only
- Manual operation:** See "[Recall... / Save...](#)" on page 417

MMEMory:LOAD:RIPple <TraceName>, <RippleLimFile>

Loads a ripple limit definition from a specified file and assigns it to a trace with a specified name. Ripple limits are created using the `CALCulate<Ch>:RIPple...` commands.

Setting parameters:

- <TraceName> Name of an existing trace in the active setup (string parameter). The imported ripple limit line is assigned to this trace, irrespective of the trace information in the ripple limit file.
- *RST: -
- <RippleLimFile> String parameter to specify the name and directory of the ripple limit file to be loaded. The default extension (manual control) for ripple limit files is *.ripple, although other extensions are allowed. If no path is specified the analyzer searches the current directory, to be queried with [MMEMory:CDIRectory?](#)

- Example:** Assume that the current setup contains two traces named Trc1 and Trc2, respectively, and that ripple limits have been defined for Trc1.
- ```
MMEM:STOR:RIPP 'TRC1', 'C:\Users\Public\Documents\Rohde-Schwarz\ZNL\LIMitLines\Lim_Trcl.limit'
```
- Store the ripple limit definition of Trc1 to a ripple limit file.
- ```
MMEM:LOAD:RIPP 'TRC2', 'C:\Users\Public\Documents\Rohde-Schwarz\ZNL\LIMitLines\Lim_Trcl.limit'
```
- Load the previously created ripple limit file and assign the limits to Trc2.
- ```
CALC:RIPP:DISPlay ON
```
- Show the ripple limit line for the active trace in the diagram.
- Usage:** Setting only
- Manual operation:** See "[Recall Ripple Test.../Save Ripple Test...](#)" on page 424

---

#### **MMEMory:LOAD:SEGMent** <Channel>, <SweepSegFile>

Replaces the related channel's current sweep segment definition by a sweep segment definition loaded from the specified ASCII file.

#### **Setting parameters:**

- <Channel> Channel number
- <SweepSegFile> String parameter to specify the name and directory of the sweep segment file to be loaded. The default extension (manual control) for sweep segment files is \*.SegList, although other extensions are allowed. If no path is specified the analyzer searches the current directory, to be queried with [MMEMory:CDIRectory?](#)

- Example:** Assume that the current channel setup contains two channels numbered 1 and 2, respectively, and that sweep segments have been defined for channel no. 1.
- ```
MMEM:STOR:SEGM 1, 'C:\Users\Public\Documents\Rohde-Schwarz\ZNL\SweepSegments\Seg_Ch1.SegList'
```
- Store the sweep segment definition of channel 1 to a sweep segment file.
- ```
MMEM:LOAD:SEGM 2, 'C:\Users\Public\Documents\Rohde-Schwarz\ZNL\SweepSegments\Seg_Ch1.SegList'
```
- Load the previously created sweep segment file and use the sweep segments for channel 2.
- Usage:** Setting only
- Manual operation:** See "[Import.../Export...](#)" on page 320

**MMEMory:LOAD:TRACe** <DestinationTraceName>, <TraceFile>[,  
<SPParamOrTraceName>]

Loads trace data from a specified trace file and assigns it to a trace with a specified name. Traces are created using the [CALCulate<Ch>:PARAMeter:SDEFine](#) command.

**Setting parameters:**

|                            |                                                                                                                                                                                                                                                                                                                                                                            |
|----------------------------|----------------------------------------------------------------------------------------------------------------------------------------------------------------------------------------------------------------------------------------------------------------------------------------------------------------------------------------------------------------------------|
| <Destination<br>TraceName> | Name of an existing data trace in the active channel setup (string parameter). The trace data is loaded into a memory trace associated with the specified data trace. If one or more memory traces are already associated with the specified data trace, the last generated memory trace is overwritten.                                                                   |
| <TraceFile>                | String parameter to specify the name and directory of the trace file to be loaded. Several file formats for trace files are supported. The file extensions *.s<n>p, *.csv, and *.dat for Touchstone, ASCII, and Matlab files are mandatory. If no path is specified the analyzer searches the current directory, to be queried with <a href="#">MMEMory:CDIRectory?</a>    |
| <SPParam<br>OrTraceName>   | Optional string parameter: For imported Touchstone files for more than one port (*.s2p, *.s3p, *.s4p), the parameter denotes the imported S-parameter ('S11', 'S12', ...). For ASCII (*.csv) and Matlab (*.dat) files, the parameter references a trace name in the file (case sensitive). If the parameter is omitted, the first trace in the specified file is imported. |

**Example:**

Assume that the current channel setup contains a trace named Trc1.

```
MMEM:STOR:TRAC 'TRC1', 'C:\Users\Public
\Documents\Rohde-Schwarz\ZNL\Traces\Trc1.s1p'
```

Store the current trace data of Trc1 to a trace file.

```
MMEM:LOAD:TRAC 'TRC1', 'C:\Users\Public
\Documents\Rohde-Schwarz\ZNL\Traces\Trc1.s1p'
```

Load the previously created trace file and create a memory trace assigned to Trc1.

```
CALC:PAR:DEF:SGR 1,2
```

Create four traces to measure the two-port S-parameters  $S_{11}$ ,  $S_{12}$ ,  $S_{21}$ ,  $S_{22}$ . The traces are not displayed.

```
MMEM:STOR:TRAC 'TRC1', 'C:\Users\Public
\Documents\Rohde-Schwarz\ZNL\Traces\Trc1.s2p'
```

Store the four S-parameter traces to a two-port Touchstone file.

```
MMEM:LOAD:TRAC 'TRC1', 'C:\Users\Public
\Documents\Rohde-Schwarz\ZNL\Traces\Trc1.s2p'
```

Load the previously created Touchstone file and overwrite the previously generated memory trace assigned to Trc1 with the  $S_{11}$  trace.

**Usage:** Setting only

**Manual operation:** See "[Import Data to New Mem](#)" on page 369

**MMEMory:LOAD:TRACe:AUTO** <TraceFile>

Loads the specified trace file and automatically distributes the imported S-parameter traces  $S_{ij}$  to all diagrams in the active channel that are currently displaying  $S_{ij}$ .

**Setting parameters:**

<TraceFile> String parameter to specify the name and directory of the trace file to be loaded. Several file formats for trace files are supported. The file extensions \*.s<n>p, \*.csv, and \*.dat for Touchstone, ASCII, and Matlab files are mandatory. If no path is specified the analyzer searches the current directory, to be queried with [MMEMory:CDIRectory?](#)

**Usage:** Setting only

**Manual operation:** See "[Auto Distribute](#)" on page 374

**MMEMory:LOAD:VNETworks<Ch>:BALanced:DEEMbedding<LogPt>**

<TouchstoneFile>[, <Port>[, <Interchange>]]

**MMEMory:LOAD:VNETworks<Ch>:BALanced:EMBedding<LogPt>**

<TouchstoneFile>[, <Port>[, <Interchange>]]

Loads the S-parameter data that (partly) specify the de-/embedding network of balanced port <LogPt> from local Touchstone files.

Use [CALCulate<Ch>:TRANSform:VNETworks:BALanced:DEEMbedding<LogPt>:TNDefinition](#) or [CALCulate<Ch>:TRANSform:VNETworks:BALanced:EMBedding<LogPt>:TNDefinition](#) to select the desired **circuit model** **before** loading the data files.

- The `FIMPort` model requires a single \*.s4p file and hence a single set command.
- The circuit models `STSL` | `STSC` | `SLST` | `SCST` require 2 \*.s2p files, that have to be assigned to the appropriate port using two set commands.

**Suffix:**

<Ch> Channel number

<LogPt> Logical port number

**Parameters:**

<TouchstoneFile> String parameter to specify the name and directory of the loaded Touchstone file. If no path is specified the analyzer searches the current directory, which can be set and queried using [MMEMory:CDIRectory?](#)

|                            |                                                                                                                                                                                                                                                                                                                                                                                                                                                                                                                                                                                                                                                                                                                                                                                                        |
|----------------------------|--------------------------------------------------------------------------------------------------------------------------------------------------------------------------------------------------------------------------------------------------------------------------------------------------------------------------------------------------------------------------------------------------------------------------------------------------------------------------------------------------------------------------------------------------------------------------------------------------------------------------------------------------------------------------------------------------------------------------------------------------------------------------------------------------------|
| <b>&lt;Port&gt;</b>        | <p>PMAin   PSECondy</p> <p>Assigns a 2-port (* .s2p) file to the appropriate port. PMAin corresponds to D1, PSECondy to D2 in the <a href="#">circuit model pictograms</a>.</p> <p>For an s4p file, this parameter is ignored. However, it must be specified unless the &lt;Interchange&gt; parameter is also omitted.</p>                                                                                                                                                                                                                                                                                                                                                                                                                                                                             |
| <b>&lt;Interchange&gt;</b> | <p>FPORts   IPORts   SGATes   SINCreasing</p> <p>Defines how to interpret the (implicit) port numbering of the Touchstone file in the context of the de-/embedding network.</p> <p><b>FPORts (or omitted)</b><br/>Standard interpretation: odd port numbers towards VNA, even port numbers towards DUT</p> <p><b>IPORts</b><br/>For s2p files IPORts means "inverted port sequence": network port 2 towards VNA, network port 1 towards DUT<br/>For s4p files IPORts means "increasing port sequence": low port numbers towards VNA, high port numbers towards DUT</p> <p><b>SGATes</b><br/>Swapped gates: even port numbers towards VNA, odd port numbers towards DUT</p> <p><b>SINCreasing</b><br/>Swapped increasing port sequence: high port numbers towards VNA, low port numbers towards DUT</p> |
| <b>Example:</b>            | <pre>*RST; SOUR:LPOR1 1,2; LPOR2 3,4 Define a balanced port configuration. CALC:TRAN:VNET:BAL:DEEM:TND STSL Select the "Serial .s2p data, shunt L" circuit model. MMEM:LOAD:VNET:BAL:DEEM2 'C:\Users\Public \Documents\Rohde-Schwarz\ZNL\VNET\Test.s2p', PMA Load a Touchstone file and assign it to logical port no. 2.</pre>                                                                                                                                                                                                                                                                                                                                                                                                                                                                         |
| <b>Manual operation:</b>   | See " <a href="#">File Name &lt;i&gt;/Swap Gates</a> " on page 496                                                                                                                                                                                                                                                                                                                                                                                                                                                                                                                                                                                                                                                                                                                                     |

---

**MMEMory:LOAD:VNETworks<Ch>:DIFFerential:EMBedding<LogPt>**  
 <TouchstoneFile>[, <Interchange>]

Lloads data of a [Differential Match Embedding](#) network from the specified Touchstone \*.s2p file.

Use [CALCulate<Ch>:TRANsform:VNETworks:BALanced:EMBedding<LogPt>:PARAmeters:DATA<Port>](#) to load circuit data from the remote client instead.

The query returns the name of the loaded file.

**Suffix:**

|                      |                                        |
|----------------------|----------------------------------------|
| <b>&lt;Ch&gt;</b>    | Channel number                         |
| <b>&lt;LogPt&gt;</b> | Logical port number of a balanced port |

**Parameters:**

<TouchstoneFile> String parameter to specify the name and directory of the loaded \*.s2p file.

If no path is specified the analyzer searches the current directory, which can be set and queried using [MMEMory:CDIRectory?](#)

<Interchange> FPORts | IPORts | SGATes

**FPORts (or omitted)**

Standard port sequence (network port 1 towards VNA, network port 2 towards DUT)

**IPORts | SGATes**

Inverted port sequence (network port 2 towards VNA, network port 1 towards DUT)

**Example:**

```
MMEM:LOAD:VNET1:DIFF:EMBM1 'C:\Users\Public\
Documents\Rohde-Schwarz\ZNL\Embedding\Test.s2p'
Load a Touchstone file.
```

**Manual operation:** See "[File Name 1](#)" on page 499

**MMEMory:LOAD:VNETworks<Ch>:GLOop:DEEMbedding <TouchstoneFile>**

**MMEMory:LOAD:VNETworks<Ch>:GLOop:EMBedding <TouchstoneFile>**

Loads data from a specified one-port (\*.s1p) Touchstone file defining a ground loop circuit model for de-/embedding.

**Suffix:**

<Ch> Channel number

**Parameters:**

<TouchstoneFile> String parameter to specify the name and directory of the loaded Touchstone file.

If no path is specified the analyzer searches the current directory, which can be set and queried using [MMEMory:CDIRectory?](#)

**Example:**

```
CALC:TRAN:VNET:SEND:GLO:TND FIMP
```

Select the 1-Port Data (s1p) circuit model.

```
MMEM:LOAD:VNET:GLO:EMB 'C:\Users\Public\
Documents\Rohde-Schwarz\ZNL\Embedding\Test.s1p'
Load a Touchstone file.
```

**Manual operation:** See "[File Name 1](#)" on page 498

**MMEMory:LOAD:VNETworks<Ch>:PPAir:DEEMbedding<ListId>**

<TouchstoneFile>[, <Port>[, <Interchange>]]

**MMEMory:LOAD:VNETworks<Ch>:PPAir:EMBedding<ListId> <TouchstoneFile>[,**

<Port>[, <Interchange>]]

Loads the S-parameter data that (partly) specify the deembedding network of port group <ListId> from local Touchstone files.

Use `CALCulate<Ch>:TRANSform:VNETworks:PPAir:DEEMbedding<ListId>:TNDefinition` or `CALCulate<Ch>:TRANSform:VNETworks:PPAir:EMBedding<ListId>:TNDefinition` to select the desired **circuit model** before loading the data files.

- For any n-port set, the `FIMPort` model requires a single `*.s<2n>p` file and hence a single set command.
- For 2-port sets (port pairs), the circuit models `STSL` | `STSC` | `SLST` | `SCST` require 2 `*.s2p` files, that have to be assigned to the appropriate port using two set commands.

**Suffix:**

|          |                                                                                       |
|----------|---------------------------------------------------------------------------------------|
| <Ch>     | Channel number                                                                        |
| <ListId> | Index of the port set within the channel's overall list of port sets for deembedding. |

**Parameters:**

|                  |                                                                                                                                                                                                                                                                                                                                                                                                                                                                                                                                                                                                                                                                                                                                                                                                                                                                              |
|------------------|------------------------------------------------------------------------------------------------------------------------------------------------------------------------------------------------------------------------------------------------------------------------------------------------------------------------------------------------------------------------------------------------------------------------------------------------------------------------------------------------------------------------------------------------------------------------------------------------------------------------------------------------------------------------------------------------------------------------------------------------------------------------------------------------------------------------------------------------------------------------------|
| <TouchstoneFile> | String parameter specifying the name and directory of the loaded Touchstone file.<br>If no path is specified, the analyzer searches the current directory, which can be set and queried using <code>MMEMemory:CDIRectory?</code>                                                                                                                                                                                                                                                                                                                                                                                                                                                                                                                                                                                                                                             |
| <Port>           | <code>PMAin</code>   <code>PSECondary</code><br>For port pairs, <Port> assigns a 2-port ( <code>*.s2p</code> ) file to the appropriate port. <code>PMAin</code> corresponds to D1, <code>PSECondary</code> to D2 in the <b>circuit model pictograms</b> for balanced ports<br>For an <code>s&lt;2m&gt;p</code> file with $m > 1$ , this parameter is ignored. However, it must be specified unless the <Interchange> parameter is also omitted.                                                                                                                                                                                                                                                                                                                                                                                                                              |
| <Interchange>    | <code>FPORts</code>   <code>IPORts</code>   <code>SGATes</code>   <code>SINCreasing</code><br>Defines how to interpret the (implicit) port numbering of the Touchstone file in the context of the deembedding network.<br><b>FPORts (or omitted)</b><br>Standard interpretation: odd port numbers towards VNA, even port numbers towards DUT<br><b>IPORts</b><br>For <code>s2p</code> files <code>IPORts</code> means "inverted port sequence": network port 2 towards VNA, network port 1 towards DUT<br>For <code>s4p</code> files <code>IPORts</code> means "increasing port sequence": low port numbers towards VNA, high port numbers towards DUT<br><b>SGATes</b><br>Swapped gates: even port numbers towards VNA, odd port numbers towards DUT<br><b>SINCreasing</b><br>Swapped increasing port sequence: high port numbers towards VNA, low port numbers towards DUT |



**Example:**           \*RST; :CALC:TRAN:VNET:PPA:DEEM:DEF 1,2,3,4  
 Define a port pair configuration with port pairs (1,2) and (3,4).  
 CALC:TRAN:VNET:PPA:DEEM2:TND STSL  
 Select the *Serial Touchstone .s2p data, shunt L* circuit mode for the second port pair.  
 MMEM:LOAD:VNET:PPA:DEEM2 'C:\Rohde-Schwarz\ZNL\Traces\Test.s2p', PMA  
 Load a Touchstone file and assign it to the second port pair.

**Manual operation:** See "File Name <i>/Inc. Seq. <i>" on page 495

---

**MMEMory:LOAD:VNETworks<Ch>:SENDEd:DEEMbedding<PhyPt>**  
 <TouchstoneFile>[, <Interchange>]

**MMEMory:LOAD:VNETworks<Ch>:SENDEd:EMBedding<PhyPt>**  
 <TouchstoneFile>[, <Interchange>]

Loads data from a specified two-port (\* .s2p) Touchstone file defining a single ended circuit model for de-/embedding.

Use

- **CALCulate<Ch>:TRANSform:VNETworks:SENDEd:DEEMbedding<PhyPt>:TNDefinition** or **CALCulate<Ch>:TRANSform:VNETworks:SENDEd:EMBedding<PhyPt>:TNDefinition** to select the adequate circuit model **before** executing this command.
- **CALCulate<Ch>:TRANSform:VNETworks:SENDEd:EMBedding<PhyPt>:PARAMeters:DATA** to load circuit data from the remote client.

**Suffix:**

<Ch>                   Channel number  
 <PhyPt>               Physical port number

**Parameters:**

<TouchstoneFile>   String parameter to specify the name and directory of the loaded Touchstone file.  
 If no path is specified the analyzer searches the current directory, which can be set and queried using **MMEMory:CDIRectory?**

<Interchange>       FPORts | IPORts | SGATes  
**FPORts (or omitted)**  
 Standard port sequence (network port 1 towards VNA, network port 2 towards DUT)  
**IPORts | SGATes**  
 Inverted port sequence (network port 2 towards VNA, network port 1 towards DUT)

**Example:**           CALC:TRAN:VNET:SEND:EMB:TND FIMP  
 Select the "Serial .s2p" data circuit model.  
 MMEM:LOAD:VNET:SEND:EMB2 'C:\Users\Public\Documents\Rohde-Schwarz\ZNL\VNET\Test.s2p'  
 Load a Touchstone file and assign it to the physical port no. 2.

**Manual operation:** See ["File Name 1 / Swap Gates"](#) on page 493

---

### MMEMory:STORe:CABLe <OutputDir>

Saves all predefined and user-defined Distance to Fault (DtF) cable types to the specified output directory.

Each DtF cable type is stored in a separate ASCII file < cable name >.rsc. The command silently overwrites files of the same name previously existing in the output directory.

#### Setting parameters:

<OutputDir> Output Directory, must be created before the command is executed

**Example:** see [MMEMory:LOAD:CABLe](#) on page 786

**Usage:** Setting only

**Options:** R&S ZNL-K3

**Manual operation:** See ["Add / Delete"](#) on page 357

---

### MMEMory:STORe:CKIT <CalKitName>, <CalKitFile>

Stores the data of a calibration kit to a specified file. The calibration kit is identified by its name.

#### Setting parameters:

<CalKitName> Name of a user-defined calibration kit available on the analyzer.  
**Tip:** It is not possible to modify or store predefined or ideal kits.

<CalKitFile> String parameter to specify the name and directory of the cal kit file to be created. The file is a network analyzer-specific cal kit file with the extension \*.calkit.  
If no path is specified the analyzer searches the current directory, to be queried with [MMEMory:CDIRectory?](#)

**Example:**

```
MMEM:LOAD:CKIT 'C:\Users\Public\Documents
\Rohde-Schwarz\ZNL\Calibration\Kits\New Kit
1.calkit'
```

Load the previously created cal kit file New Kit 1.calkit from the default cal kit directory.

```
... :MMEM:STOR:CKIT 'New Kit 1', 'C:
\Users\Public\Documents
\Rohde-Schwarz\ZNL\Calibration\Kits\New Kit
1.calkit'
```

Store the data for the user-defined cal kit "New Kit 1" and overwrite the cal kit file New Kit 1.calkit.

**Usage:** Setting only

**Manual operation:** See ["Import Cal Kit... / Export Cal Kit..."](#) on page 472

---

**MMEMory:STORe:CKIT:WLABel** <CalKitName>, <KitLabel>, <CalKitFile>

Stores the data of a calibration kit to a specified file. The calibration kit is identified by its name and label.

**Setting parameters:**

|              |                                                                                                                                                                                                                                                                                           |
|--------------|-------------------------------------------------------------------------------------------------------------------------------------------------------------------------------------------------------------------------------------------------------------------------------------------|
| <CalKitName> | Name of a user-defined calibration kit available on the analyzer.<br><b>Tip:</b> It is not possible to modify or store predefined or ideal kits.                                                                                                                                          |
| <KitLabel>   | Label of the calibration kit, usually its serial number.                                                                                                                                                                                                                                  |
| <CalKitFile> | String parameter to specify the name and directory of the cal kit file to be created. The file is a NWA-specific cal kit file with the extension *.calkit.<br>If no path is specified the analyzer searches the current directory, to be queried with <a href="#">MMEMory:CDIRectory?</a> |

**Example:** See [\[SENSe:\]CORRection:CKIT:LLABel](#)

**Usage:** Setting only

---

**MMEMory:STORe:CORRection** <Channel>, <CalGroupFile>

Copies the correction data of channel <Channel> to the cal pool, generating a new correction data file (cal group). The file has the extension \*.cal and is stored in the C:\Users\Public\Documents\Rohde-Schwarz\ZNL\Calibration\Data directory.

**Setting parameters:**

|                |                                                                                                                                                                                                                                                                             |
|----------------|-----------------------------------------------------------------------------------------------------------------------------------------------------------------------------------------------------------------------------------------------------------------------------|
| <Channel>      | Channel number                                                                                                                                                                                                                                                              |
| <CalGroupFile> | String parameter to specify the name of the created cal group file. There is no need to specify the directory path and file extension; the analyzer uses the default cal pool directory C:\Users\Public\Documents\Rohde-Schwarz\ZNL\Calibration\Data and a *.cal extension. |

**Example:** See [MMEMory:LOAD:CORRection](#)

**Usage:** Setting only

**Manual operation:** See "Add / Add All... / Replace / Apply / Apply to All" on page 481

---

**MMEMory:STORe:LIMit** <TraceName>, <LimLineFile>

Saves the limit lines associated to a specified trace to a limit line file. Limit lines are created using the `CALCulate<Chn>:LIMit...` commands.

**Setting parameters:**

|             |                                                                                                                    |
|-------------|--------------------------------------------------------------------------------------------------------------------|
| <TraceName> | Name of an existing trace in the active channel setup (string parameter) for which a limit line definition exists. |
|-------------|--------------------------------------------------------------------------------------------------------------------|

<LimLineFile> String parameter to specify the name and directory of the created limit line file. The default extension (manual control) for limit line files is \*.limit, although other extensions are allowed. If no path is specified the analyzer searches the current directory, to be queried with [MMEemory:CDIRectory?](#)

**Example:** See [MMEemory:LOAD:LIMit](#)

**Usage:** Setting only

**Manual operation:** See "[Recall... / Save...](#)" on page 417

### **MMEemory:STORe:MARKer** <AsciiFile>

Saves the values of all markers to an ASCII file.

#### **Setting parameters:**

<AsciiFile> String parameter to specify the name and directory of the created ASCII file. The default extension (manual control) for marker files is \*.txt, although other extensions are allowed. If no path is specified the analyzer searches the current directory, to be queried with [MMEemory:CDIRectory?](#)

**Example:** \*RST  
Reset the analyzer, creating the default trace no. 1 in channel no. 1.  
CALC:MARK ON; MARK:X 1GHz  
Create marker no. 1 and place it to 1 GHz.  
CALC:MARK2 ON; MARK2:X 2GHz  
Create a second marker and place it to 2 GHz.  
MMEemory:STOR:MARK 'Marker.txt'  
Store the marker values to an ASCII file. The file contains both marker values, e.g.:  
Trc1 S21  
Mkr 1 1.000000 GHz -4.900 dB  
Mkr 2 2.000000 GHz -6.807 dB

**Usage:** Setting only

**Manual operation:** See "[Export Markers](#)" on page 434

### **MMEemory:STORe:RIPPlE** <TraceName>, <RippleLimFile>

Saves the ripple limits associated with a specified trace to a ripple limit file. Ripple limit definitions are created using the [CALCulate<Chn>:RIPPlE...](#) commands.

#### **Setting parameters:**

<TraceName> Name of an existing trace in the active setup (string parameter) for which a ripple limit definition exists.

<RippleLimFile> String parameter to specify the name and directory of the created ripple limit file. The default extension (manual control) for ripple limit files is \*.ripple, although other extensions are allowed.  
If no path is specified the analyzer searches the current directory, to be queried with [MMEMory:CDIRectory?](#)

**Example:** See [MMEMory:LOAD:LIMit](#)

**Usage:** Setting only

**Manual operation:** See "Recall Ripple Test.../Save Ripple Test..." on page 424

**MMEMory:STORe:SEGMENT** <Channel>, <SweepSegFile>

Saves the sweep segment definition of the related channel to a an ASCII file. Sweep segments are defined using [\[SENSe:\]SEGMENT<Seg>...](#) commands.

**Setting parameters:**

<Channel> Channel number

<SweepSegFile> String parameter to specify the name and directory of the created sweep segment file. The default extension (manual control) for sweep segment files is \*.SegList, although other extensions are allowed.  
If no path is specified the analyzer searches the current directory, to be queried with [MMEMory:CDIRectory?](#)

**Example:** See [MMEMory:LOAD:SEGMENT](#)

**Usage:** Setting only

**Manual operation:** See "Import.../Export..." on page 320

**MMEMory:STORe:TRACe** <TraceName>, <TraceFile>[, <FormatInd>[, <Format>[, <DecSeparator>[, <FieldSeparator>]]]]

Stores the trace data of a specified data trace to a trace file. Traces are created using the [CALCulate<Ch>:PARAMeter:SDEFine](#) command.

**Tip:** \*.s<n>p Touchstone files (<n> = 1, 2, 3, ...) are intended for a complete set of <n>-port S-parameters. Data export fails if the active channel does not contain the full set of <n><sup>2</sup> traces or if the involved ports are not numbered consecutively, starting with port 1. If the necessary traces are available, '<trc\_name>' can be the name of any of the traces. To create Touchstone files while less than <n><sup>2</sup> single-ended traces are available, use [MMEMory:STORe:TRACe:PORTs](#).

**Setting parameters:**

<TraceName> Name of an existing data trace in the active channel setup (string parameter).

|                  |                                                                                                                                                                                                                                                                                                                                                                                                                                                                                                                        |
|------------------|------------------------------------------------------------------------------------------------------------------------------------------------------------------------------------------------------------------------------------------------------------------------------------------------------------------------------------------------------------------------------------------------------------------------------------------------------------------------------------------------------------------------|
| <TraceFile>      | String parameter to specify the name and directory of the created trace file. Several file formats for trace files are supported. The file extensions *.s<n>p, *.csv, and *.dat for Touchstone, ASCII, and Matlab files are mandatory. To generate a multiport Touchstone file *.s2p, *.s3p..., the channel must contain traces for the full set of S-parameters; the '<trc_name>' is ignored. If no path is specified the analyzer uses the current directory, to be queried with <code>MMEemory:CDIRectory?</code> . |
| <FormatInd>      | FORMatted   UNFormatted<br>UNFormatted - unformatted data export specified by the second optional parameter.<br>FORMatted - formatted data export (for *.csv and *.dat files only).<br>If the first optional parameter is omitted, the command stores unformatted data.                                                                                                                                                                                                                                                |
| <Format>         | COMPLex   LINPhase   LOGPhase<br>COMPLex - complex values (real and imaginary part)<br>LINPhase - linear magnitude and phase.<br>LOGPhase - dB-magnitude and phase.<br>If the second optional parameter is omitted, the command stores complex data.                                                                                                                                                                                                                                                                   |
| <DecSeparator>   | POINT   COMMa<br>POINT - decimal separator: point.<br>COMMa - decimal separator: comma.<br>If the third optional parameter is omitted, points are used.                                                                                                                                                                                                                                                                                                                                                                |
| <FieldSeparator> | SEMicolon   COMMa   TABulator   SPACe<br>SEMicolon - field separator: semicolon<br>COMMa - field separator: comma.<br>TABulator - field separator: tabulator.<br>SPACe - field separator: space.<br>If the fourth optional parameter is omitted, semicolons are used.                                                                                                                                                                                                                                                  |

**Example:** See `MMEemory:LOAD:TRACe`

**Usage:** Setting only

**Manual operation:** See "Save" on page 373

---

**MMEemory:STORe:TRACe:CHANnel** <Channel>, <TraceFile>[, <FormatInd>[, <Format>[, <DecSeparator>[, <FieldSeparator>]]]]

Stores the trace data of all data traces in the specified channel to a trace file. Traces are created using the `CALCulate<Ch>:PARAMeter:SDEFine` command.

**Tip:** \*.s<n>p Touchstone files (<n> = 1, 2, 3, ...) are intended for a complete set of <n>-port S-parameters. Data export fails if the active channel does not contain the full set of <n><sup>2</sup> traces.

**Setting parameters:**

|                  |                                                                                                                                                                                                                                                                                                                                                                                                                                                                                       |
|------------------|---------------------------------------------------------------------------------------------------------------------------------------------------------------------------------------------------------------------------------------------------------------------------------------------------------------------------------------------------------------------------------------------------------------------------------------------------------------------------------------|
| <Channel>        | Channel number in the active channel setup. ALL means that a separate file is created for each channel in the active channel setup.                                                                                                                                                                                                                                                                                                                                                   |
| <TraceFile>      | String parameter to specify the name and directory of the created trace file. Several file formats for trace files are supported. The file extensions *.s<n>p, *.csvc, and *.dat for Touchstone, ASCII, and Matlab files are mandatory. To generate a multiport Touchstone file *.s2p, *.s3p . . . , the channel must contain traces for the full set of S-parameters. If no path is specified the analyzer uses the<br>C:\Users\Public\Documents\Rohde-Schwarz\ZNL\Traces directory. |
| <FormatInd>      | FORMatted   UNFormatted<br><br>UNFormatted - unformatted data export specified by the second optional parameter.<br>FORMatted - formatted data export (for *.csv and *.dat files only).<br>If the first optional parameter is omitted, the command stores unformatted data.                                                                                                                                                                                                           |
| <Format>         | COMPLex   LINPhase   LOGPhase<br><br>COMPLex - complex values (real and imaginary part)<br>LINPhase - linear magnitude and phase.<br>LOGPhase - dB-magnitude and phase.<br>If the second optional parameter is omitted, the command stores complex data.                                                                                                                                                                                                                              |
| <DecSeparator>   | POINT   COMMa<br><br>POINT - Decimal separator: point.<br>COMMa - Decimal separator: comma.<br>If the third optional parameter is omitted, points are used.                                                                                                                                                                                                                                                                                                                           |
| <FieldSeparator> | SEMicolon   COMMa   TABulator   SPACe<br><br>SEMicolon - Field separator: semicolon<br>COMMa - field separator: comma.<br>TABulator - field separator: tabulator.<br>SPACe - field separator: space.<br>If the third optional parameter is omitted, semicolons are used.                                                                                                                                                                                                              |

**Example:**            \*RST; :CONF:TRAC:NAME?  
 Reset the instrument, creating a default channel no 1 and a default trace Trc1.  
 CALC:PAR:DEF:SGR 1,2  
 Create four traces to measure the two-port S-parameters  $S_{11}$ ,  $S_{12}$ ,  $S_{21}$ ,  $S_{22}$ . The traces are not displayed.  
 MMEM:STOR:TRAC:CHAN 1, 'C:\Users\Public\Documents\Rohde-Schwarz\ZNL\Traces\Chn1.csv'  
 Store all trace data of channel 1 to a trace file.  
 MMEM:STOR:TRAC:CHAN 1, 'C:\Users\Public\Documents\Rohde-Schwarz\ZNL\Traces\Chn1.s2p'  
 Store the four S-parameter traces to a two-port Touchstone file. The Touchstone file will not contain the default trace Trc1.

**Usage:**            Setting only

**Manual operation:** See ["Save"](#) on page 373

---

**MMEMory:STORe:TRACe:OPTion:BALanced** <Boolean>

**MMEMory:STORe:TRACe:OPTion:SYMMetric** <Boolean>

This command enables/disables the export of balanced (symmetric) S-parameters for [MMEMory:STORe:TRACe:PORTs](#).

**Parameters:**

<Boolean>

---

**MMEMory:STORe:TRACe:OPTion:PLUS** <arg0>

This command defines how positive numbers are prefixed during Touchstone file export: by a leading space, a plus sign or not at all.

**Parameters:**

<arg0>            SPACe | PLUS | VOID

**Manual operation:** See ["Positive Number Prefix"](#) on page 146

---

**MMEMory:STORe:TRACe:OPTion:SSEParator** <Boolean>

This command defines whitespace insertion during Touchstone file export.

If set to ON, separator lines are skipped, i.e. the content parts are no longer separated by blank lines.

**Parameters:**

<Boolean>

**Manual operation:** See ["Skip Separator Lines"](#) on page 146

---

**MMEMory:STORe:TRACe:OPTion:TABS** <Boolean>

This command defines whitespace insertion during Touchstone file export.



If set to ON, columns are separated by tabs rather than spaces.

**Parameters:**

<Boolean>

**Manual operation:** See ["Use TAB \(instead of blanks\)"](#) on page 146

**MMEMory:STORe:TRACe:OPTion:TRIM** <Boolean>

This command defines whitespace insertion during Touchstone file export.

If set to ON, whitespace at the beginning of each line is removed.

**Parameters:**

<Boolean>

**Manual operation:** See ["Trim Leading Whitespace"](#) on page 146

**MMEMory:STORe:TRACe:PORTs** <Channel>, <TouchstoneFile>, <Format>[, <ModelImpedance>, <Port>[, <Port>]...]

Generates an `snp` Touchstone file, where `n` is the number of specified ports.

If ports 1 and 2 are specified and configured as balanced port, and if export of [Balanced Params](#) is enabled, then the Touchstone file contains the full set of balanced S-parameters. Otherwise, it contains the full set of single-ended S-parameters. Both sets have a size of  $n^2$ .

The command fails unless the conditions for Touchstone file export are met; see ["Conditions for Touchstone File Export"](#) on page 244. Traces are created using the `CALCulate<Ch>:PARAMeter:SDEFine` command.

**Setting parameters:**

|                     |                                                                                                                                                                                                                                                                                                                |
|---------------------|----------------------------------------------------------------------------------------------------------------------------------------------------------------------------------------------------------------------------------------------------------------------------------------------------------------|
| <Channel>           | Channel number in the active channel setup.                                                                                                                                                                                                                                                                    |
| <TouchstoneFile>    | String parameter to specify the name and directory of the created Touchstone file. The file extension <code>*.snp</code> for an <code>n</code> -port Touchstone file is mandatory.<br>If no path is specified the analyzer searches the current directory, to be queried with <code>MMEMory:CDIRectory?</code> |
| <Format>            | COMPLex   LINPhase   LOGPhase<br>COMPLex - complex values (real and imaginary part).<br>LINPhase - Linear magnitude and phase.<br>LOGPhase - dB-magnitude and phase.                                                                                                                                           |
| <ModelImpedance>    | CIMPedance   PIMPedance<br><b>CIMPedance</b> (default, if omitted): normalize to a common target impedance of 50 $\Omega$<br><b>PIMPedance</b> : normalize to the individual port reference impedances<br>See <a href="#">"Renormalization of S-Parameters"</a> on page 245.                                   |
| <Port>, <Port>, ... | Physical port numbers                                                                                                                                                                                                                                                                                          |

<Port>

**Example:** Suppose that a full two-port calibration for ports 1 and 2 and channel 1 has been performed, and that a DUT with two balanced ports is connected. The analyzer measures an arbitrary mixed mode S-parameter.

```
MMEM:STOR:TRAC:PORT 1, 'Test_CIMP.s2p',
COMPLex, CIMPedance, 1, 2
```

Calculate all single-ended S-parameters, renormalize them to the common target impedance and store them to a two-port Touchstone file.

```
MMEM:STOR:TRAC:PORT 1, 'Test_PIMP.s2p',
COMPLex, PIMPedance, 1, 2
```

Calculate all single-ended S-parameters, renormalize them to the individual port reference impedances and store them to a two-port Touchstone file.

**Usage:** Setting only

**Manual operation:** See "Save" on page 373

### 11.5.2.11 OUTPut Commands

The `OUTPut...` commands control the characteristics of the analyzer's output ports.

|                                                                      |     |
|----------------------------------------------------------------------|-----|
| <code>OUTPut:UPORt:ECBits</code> .....                               | 810 |
| <code>OUTPut&lt;Ch&gt;[:STATe]</code> .....                          | 810 |
| <code>OUTPut&lt;Ch&gt;:UPORt:SEGMENT&lt;Seg&gt;:STATe</code> .....   | 811 |
| <code>OUTPut&lt;Ch&gt;:UPORt:SEGMENT&lt;Seg&gt;[:VALue]</code> ..... | 811 |
| <code>OUTPut&lt;Ch&gt;:UPORt[:VALue]</code> .....                    | 813 |

---

#### `OUTPut:UPORt:ECBits` <Boolean>

Defines the usage of pins 16 to 19 of the USER PORT connector.

**Parameters:**

<Boolean>            ON – channel bits 4 to 7  
                       OFF – drive port 1 to 4  
                       \*RST:        ON

**Example:** See `OUTPut<Ch>:UPORt[:VALue]`

**Manual operation:** See "Pin 16 - 19" on page 490

---

#### `OUTPut<Ch>[:STATe]` <Boolean>

Turns the internal source power at all ports on or off.

**Suffix:**

<Ch>                    Channel number. This suffix is ignored; the setting is valid for all channels.

**Parameters:**

<Boolean> ON | OFF - switch the power on or off.  
\*RST: ON

**Example:**

OUTP OFF  
Turn off the RF source power.

**Manual operation:** See ["RF Off All Channels"](#) on page 298

**OUTPut<Ch>:UPORt:SEGMent<Seg>:STATe <Boolean>**

Enables or disables segment bits for the sweep segments in channel no. <Ch>; see `OUTPut<Ch>:UPORt:SEGMent<Seg>[:VALue]`. The command is valid for segmented frequency sweep.

**Suffix:**

<Ch> Channel number.  
<Seg> Sweep segment number. This suffix is ignored; the setting is valid for all segments.

**Parameters:**

<Boolean> ON | OFF - Enables or disables channel bits.  
\*RST: OFF

**Example:**

See `OUTPut<Ch>:UPORt:SEGMent<Seg>[:VALue]` on page 811

**Manual operation:** See ["Optional Columns"](#) on page 321

**OUTPut<Ch>:UPORt:SEGMent<Seg>[:VALue] <BinValue>**

Sets or queries a sweep segment-dependent four-bit binary value to control four independent output signals at the USER PORT connector (lines 16, 17, 18, 19). The output signals are 3.3 V TTL signals which can be used to differentiate between up to 16 independent analyzer states for each channel. The command is valid for segmented frequency sweeps. It is analogous to the channel-dependent command `OUTPut<Ch>:UPORt[:VALue]`.

The bits for the sweep segments must be enabled explicitly using `OUTPut<Ch>:UPORt:SEGMent:STATe`.

**Segment bit definition and activation**

The segment bits have the following properties:

- After a \*RST of the analyzer all segment bits are set to zero; no signal is applied to pins 16 to 19 of the USER PORT connector.
- The value defined with `OUTPut<Ch>:UPORt:SEGMent<Seg>[:VALue]` is assigned to segment no. <Seg> in channel no. <Ch>.
- The signals at the USER CONTROL connector reflect the segments bits of the currently measured segment.

- The signals are switched on as soon as a measurement in a segment with non-zero segment bits is started. They are changed whenever a segment with different segment bits is measured.
- The signals at the USER PORT connector are maintained after the analyzer enters the hold state. This happens in single sweep mode after all sweep sequences have been terminated.

**Tip:**

You can use the active segment number as a parameter for `OUTPut<Ch>:UPOrt:SEGMent<Seg>[:VALue]` and monitor the measurement in up to 16 different segments per channel at the USER PORT connector; see example below. You can also use the USER PORT output signals as segment-dependent trigger signals for external devices. Use `CONTRol:AUXiliary:C[:DATA]` to transfer the four bit value in decimal representation.

**Suffix:**

<Ch> Channel number.  
 <Seg> Sweep segment number

**Parameters:**

<BinValue> Binary value. The transferred values correspond to the following states of the USER CONTROL connector:  
 #B0000 - no signal at any of the four pins 16, 17, 18, 19  
 #B0001 - output signal at pin 16  
 #B0010 - output signal at pin 17  
 #B0011 - output signal at pin 16 and 17  
 ...  
 #B1111 - output signal at pin 16, 17, 18 and 19  
 Range: #B0000 to #B1111 (for setting command), 0 to 15 (query)  
 \*RST: #B0000 (0)

**Example:**

```
*RST; :SEGM:INS 1MHZ, 1.5MHZ, 111, -21DBM,
0.5S, 0, 10KHZ
```

Create a sweep segment no. 1 with a sweep range between 1.0 MHz and 1.5 MHz.

```
SWE:TYPE SEGM
```

Set the segmented frequency sweep active.

```
OUTP:UPOR:SEGM:STAT ON
```

Enable segment bits.

```
OUTP:UPOR:SEGM1 #B0001
```

Assign the segment bit value #B0001 to segment no. 1. The output signal at pin 16 is switched on while the first segment is measured.

```
SEGM2:ADD
```

Create a second sweep segment. The frequency range of the second segment will be between 1.5 MHz and the maximum frequency of the analyzer.

```
OUTP:UPOR:SEGM2 #B0010
```

Assign the segment bit value #B0010 to segment no. 2. While the analyzer measures the second segment, the output signal changes from pin 16 to pin 17.

**Manual operation:** See "[Optional Columns](#)" on page 321

---

**OUTPut<Ch>:UPORt[:VALue] <BinValue>**

Sets or queries a channel-dependent eight-bit binary value to control eight independent output signals at the USER PORT connector (lines 8, 9, 10, 11 and lines 16, 17, 18, 19). The output signals are 3.3 V TTL signals which can be used to differentiate between up to 255 independent analyzer states. `OUTPut<Ch>:UPORt[:VALue]` itself does not change the analyzer state.

**Channel bit definition and activation**

The channel bits have the following properties:

- After a `*RST` of the analyzer all channel bits (including the value for the active, sweeping channel no. 1) are set to zero; no signal is applied to pins 8 to 11 and 16 to 19 of the USER PORT connector.
- The value defined with `OUTPut<Ch>:UPORt[:VALue]` is assigned to channel no. <Ch>.
- The signals at the USER PORT connector reflect the channel bits of the **measuring** channel, i.e. the channel for which the analyzer performs a sweep. This channel is not necessarily identical with the active channel.
- The signals are switched on as soon as a measurement (sweep) in a channel with non-zero channel bits is started. They are changed whenever a channel with different channel bits becomes the measuring channel.
- The signals at the USER PORT connector are maintained after the analyzer enters the hold state. This happens if all channels use single sweep mode and if all sweep sequences have been terminated.

- Pins 16 to 19 may be reserved for monitoring the drive ports 1 to 4 of the analyzer (OUTPut<Ch>:UPORt:ECBits OFF). This leaves up to 16 different monitored channel states.

**Tip:** You can use the active channel number as a parameter for OUTPut<Ch>:UPORt[:VALue] and monitor the activity of up to 255 different channels at the USER PORT connector; see example below. You can also use the USER PORT output signals as channel-dependent (or drive port-dependent) trigger signals for external devices. Furthermore you can use CONTrol:AUXiliary:C[:DATA] to transfer the eight bit value in decimal representation.

**Suffix:**

<Ch> Channel number

**Parameters:**

<BinValue> Binary value. The values correspond to the following states of the USER PORT connector:  
 #B00000000 - no signal at any of the eight pins 8, 9, 10, 11, 16, 17, 18, 19  
 #B00000001 - output signal at pin 8  
 #B00000010 - output signal at pin 9  
 #B00000011 - output signal at pins 8 and 9  
 ...  
 #B11111111 - output signal at pins 8, 9, 10, 11, 16, 17, 18, 19  
 Range: #B00000000 to #B11111111 (for setting command),  
 0 to 255 (query)  
 \*RST: #B00000000 (0)

**Example:**

```
*RST; :OUTP1:UPOR #B00000001
```

Assign the channel bit value #B00000001 to the active channel no. 1. The analyzer performs a measurement in channel no. 1, therefore the output signal at pin 8 is switched on.

```
CONF:CHAN2:STAT ON; OUTP2:UPOR #B00000010
```

Create channel no. 2, causing it to become the active channel, and assign the channel bit value #B00000010. The analyzer performs no measurement in channel no. 2, therefore the output signal is not changed.

```
CALC2:PAR:SDEF 'Ch2Tr1', 'S11'
```

Create a trace named 'Ch2Tr1' and assign it to channel 2. While the analyzer measures in channel 2, the output signal changes from pin 8 to pin 9.

```
OUTP:UPOR:ECB OFF
```

Reserve pin 16 to 19 for monitoring the drive ports of the analyzer.

**Manual operation:** See "[Channel Bits \(Decimal\)](#)" on page 489

### 11.5.2.12 PROGRAM Commands

The PROGRAM... commands control external application programs that can be run on the analyzer.

|                                      |     |
|--------------------------------------|-----|
| PROGram[:SElected]:EXECute.....      | 815 |
| PROGram[:SElected]:INIMessage.....   | 816 |
| PROGram[:SElected]:INIParameter..... | 816 |
| PROGram[:SElected]:NAME.....         | 817 |
| PROGram[:SElected]:RETVAl?.....      | 817 |
| PROGram[:SElected]:WAIT.....         | 818 |

---

### PROGram[:SElected]:EXECute <AppName>

Starts an application process or open a file using an application available on the analyzer.

Use the command sequence `PROGram[:SElected]:WAIT? ; PROGram[:SElected]:RETVAl?` to query the return value (see example below).

**Note:** It is not possible to run several programs simultaneously. If the command `PROGram[:SElected]:EXECute ...` is sent while a previously started program is still executed, the analyzer generates a SCPI error -100, "Command error...".

#### Tip: Executing batch files; command prompt

When executing batch scripts or other DOS applications, the analyzer does not display any DOS windows; the screen is left for the vector network analyzer (VNA) application. The same applies to the Windows NT command prompt (`cmd.exe`). To access the command prompt, proceed as follows:

- Create a batch file (e.g. `Start_cmd.bat`) containing the command line `start cmd.exe` and store the file to `C:\Winnt\system32`.
- Execute the batch file: `PROG:EXEC 'C:\winnt\system32\Start_cmd.bat'`

The command prompt window is displayed in front of the VNA application. You can also open several command prompt windows simultaneously.

#### Setting parameters:

<AppName> String variable containing the name and path of an application program to be executed or of a file to be opened. The path can be defined as an absolute path (e.g. 'c:\...') or relative to the current directory (`MMEMory:CDIRectory`).  
Blanks in the <AppName> can be used to separate the application name from (optional) parameters.

#### Example:

```
PROGram:SElected:NAME PROG
Select general program execution.
PROGram:SElected:EXECute 'Exit42.bat'
Run batch script Exit42.bat.
PROGram:SElected:WAIT?
Lock command execution and manual control of the analyzer
until the batch job has finished. This is required for
PROGram:SElected:RETVAl?
Get the return value. The answer is ... 42.
```

**Usage:** Setting only

**PROGram[:SElected]:INIMessage** <IniFile>[, <SendValue>]

Writes a message <SendValue> into the preferences (\*.ini) file specified by <IniFile>. The message is entered into the [MESSAGE] section using the fixed key `Send`; the value for the fixed key `Receive` is set to an empty string.

The query reads the value associated with the fixed key `Receive` from the [MESSAGE] section of the preferences file specified by <IniFile>. If no value exists for that key, the query returns an empty string.

Both commands can be used to establish a simple file-based two-way communication mechanism to an external application launched by **PROGram[:SElected]:EXECute**; see example.

**Parameters:**

|                          |                                                                                                                                                                                                              |
|--------------------------|--------------------------------------------------------------------------------------------------------------------------------------------------------------------------------------------------------------|
| <b>&lt;IniFile&gt;</b>   | Name and path of the *.ini file. The *.ini extension may be omitted as it is created automatically by the command. The specified path/directory must exist. If the *.ini file does not exist, it is created. |
| <b>&lt;SendValue&gt;</b> | Value for the fixed key <code>Send</code> .                                                                                                                                                                  |

**Example:**

```
PROG:INIM 'c:\preferences\myapp', 'this is a message'
```

Write the string `this is a message` into the file `c:\preferences\myapp.ini`. The contents of the file look like:

```
[MESSAGE] Send="this is a message" Receive=
```

Suppose the external program writes the string `this is a response` to the `Receive` key (and possibly deletes the contents of the `Send` key).

```
PROG:INIM? 'c:\preferences\myapp'
```

Query the value of the key `Receive` in the \*.ini file. The response is `"this is a response"`.

**PROGram[:SElected]:INIPParameter** <IniFile>{ , <Key>,<Value> | '<Value>'}

Defines and writes one or several key/value pairs into the preferences file (\*.ini) specified by <file\_path>. The information is entered into the [PARAMETER] section.

This command can be used to supply information to an external application launched by **PROGram[:SElected]:EXECute**.

The query must be sent with a single <Key> value. It reads the value associated with the key from the [PARAMETER] section of the preferences file specified by <file\_path>. If the key/value pair does not exist, the query returns an empty string.

**Parameters:**

|                        |                                                                                                                                                                                                              |
|------------------------|--------------------------------------------------------------------------------------------------------------------------------------------------------------------------------------------------------------|
| <b>&lt;IniFile&gt;</b> | Name and path of the *.ini file. The *.ini extension may be omitted as it is created automatically by the command. The specified path/directory must exist. If the *.ini file does not exist, it is created. |
|------------------------|--------------------------------------------------------------------------------------------------------------------------------------------------------------------------------------------------------------|



<Key> Key for the key/value pair(s).

<Value> String or numeric value for the key/value pair(s). If a string parameter is supplied, it has to be enclosed in single or double quotes.

**Example:**

```

PROG:INIP 'c:\preferences\myapp',
'myparameter', 'myvalue', 'startf', 123.05
Write two key/value pairs into the file
c:\preferences\myapp.ini. The contents of the file look
like:
[PARAMETER]
myparameter="myvalue"
startf="123.05"
PROG:INIP? 'c:\preferences\myapp',
'myparameter'
Query the value of the key myparameter in the *.ini file. The
response is "myvalue".

```

---

### PROG:SELected:NAME <Program>

Selects the application to be run on the analyzer. At present, only the general parameter PROG is available. This means that `PROG[:SELected]:EXECute` can start any program.

**Tip:** Use this command in order to avoid problems should the default value change in future firmware versions.

#### Parameters:

<Program> PROG  
Any program running under Windows or any file that can be opened with an application program available on the analyzer.

\*RST: PROG

**Example:** See `PROG[:SELected]:EXECute`

---

### PROG:SELected:RETVal?

Queries the return value of an application or process started via `PROG[:SELected]:EXECute`.

This will only be successful if preceded by a `PROG[:SELected]:WAIT?` query (see `PROG[:SELected]:WAIT` on page 818).

**Example:** See `PROG[:SELected]:EXECute`

**Usage:** Query only

**PROGram[:SElected]:WAIT**

Locks command execution from the current controller program while a program started via `PROGram[:SElected]:EXECute` is running. The analyzer does not execute any further commands or queries until the program is stopped or paused.

Use `PROGram[:SElected]:WAIT?` before trying to retrieve the return value of the executed program (`PROGram[:SElected]:RETVal?`).

**Example:** See `PROGram[:SElected]:EXECute`

**11.5.2.13 [SENSe:] Commands**

The `[SENSe:]...` commands affect the receiver settings of the R&S ZNL/ZNLE.

**[SENSe:]AVERage...**

The `[SENSe:]AVERage...` commands set sweep averaging parameters. The sweep average is a noise-reduction technique which consists of calculating each measurement point as an average of the same measurement point over several consecutive sweeps.



In contrast to the sweep count (for single sweep mode, `[SENSe<Ch>:]SWEep:COUNT`), averaging is always channel-specific. Both features are completely independent from each other.

|                                                      |     |
|------------------------------------------------------|-----|
| <code>[SENSe&lt;Ch&gt;:]AVERage[:STATe]</code> ..... | 818 |
| <code>[SENSe&lt;Ch&gt;:]AVERage:CLEar</code> .....   | 819 |
| <code>[SENSe&lt;Ch&gt;:]AVERage:COUNT</code> .....   | 819 |
| <code>[SENSe&lt;Ch&gt;:]AVERage:MODE</code> .....    | 819 |

**[SENSe<Ch>:]AVERage[:STATe] <Boolean>**

Enable or disable the sweep average.

**Suffix:**

<Ch> Channel number

**Parameters:**

<Boolean> ON | OFF - enables or disables the automatic calculation of the sweep average over the specified number of sweeps (`[SENSe<Ch>:]AVERage:COUNT`).

\*RST: ON

**Example:** See `[SENSe<Ch>:]AVERage:CLEar`

**Manual operation:** See "Factor / On / Reset" on page 308

---

**[SENSe<Ch>:]AVERage:CLEar**

Starts a new average cycle, clearing all previous results and thus eliminating their effect on the new cycle.

**Suffix:**

<Ch> Channel number

**Example:**

```
SENS1:AVER:COUN 15; :AVER ON
```

Set the average factor for channel 1 to 15 (the mnemonic SENS1 can be omitted) and enable the sweep average.

```
AVER:COUN 5; CLE
```

Reduce the average factor and restart the average.

**Usage:** Event

**Manual operation:** See "[Factor / On / Reset](#)" on page 308

---

**[SENSe<Ch>:]AVERage:COUNT <AverageFactor>**

Defines the number of consecutive sweeps to be combined for the sweep average ("Factor").

**Suffix:**

<Ch> Channel number

**Parameters:**

<AverageFactor> Sweep average factor

Range: 1 to 1000

\*RST: 10

**Example:** See [\[SENSe<Ch>:\]AVERage:CLEar](#)

**Manual operation:** See "[Factor / On / Reset](#)" on page 308

---

**[SENSe<Ch>:]AVERage:MODE <Mode>****Suffix:**

<Ch>

**Parameters:**

<Mode> AUTO | FLATten | REDuce | MOVing

**AUTO**

Automatic selection between REDuce and FLATten mode, depending on the trace format.

**FLATten**

Cumulative moving averages of the (linear) magnitude and phase values, provides the most effective noise suppression for the "dB Mag", "Phase", "Unwr Phase", and "Lin Mag" formats.

**REDuce**

Cumulative moving averages of the real and imaginary parts of each measurement result, provides the most effective noise suppression for the "Real" and "Imag" formats and for complex trace formats.

**MOVing**

Simple moving averages of the real and imaginary parts of each measurement result; similar to REDuce, but with finite history.

**Manual operation:** See "Mode" on page 309

**[SENSe:]BANDwidth...**

The [SENSe:]BANDwidth... commands set the bandwidth of the IF filter (measurement bandwidth). The forms BANDwidth and BWIDth are equivalent.

|                                                |     |
|------------------------------------------------|-----|
| [SENSe<Ch>:]BANDwidth[:RESolution].....        | 820 |
| [SENSe<Ch>:]BWIDth[:RESolution].....           | 820 |
| [SENSe<Ch>:]BANDwidth[:RESolution]:SElect..... | 821 |
| [SENSe<Ch>:]BWIDth[:RESolution]:SElect.....    | 821 |

---

**[SENSe<Ch>:]BANDwidth[:RESolution] <ResBandw>**

**[SENSe<Ch>:]BWIDth[:RESolution] <IF Bandwidth>**

Defines the IF bandwidth of the analyzer (measurement bandwidth). Values between 1 Hz and 500 kHz can be set.

**Suffix:**

<Ch> Channel number

**Parameters:**

<IF Bandwidth> Bandwidths can be set in 1 – 1.5 – 2 – 3 – 5 – 7 steps. The analyzer rounds up any entered value between these steps and rounds down values exceeding the maximum bandwidth.

Range: See above

\*RST: 10 kHz

Default unit: Hz

**Example:**

BAND 1.1

Set a IF bandwidth of approx. 1.1 Hz for channel 1.

BAND?

The analyzer returns the rounded bandwidth of 1.5 Hz.

**Manual operation:** See "Bandwidth" on page 307

**[SENSe<Ch>:]BANDwidth[:RESolution]:SElect <Selectivity>**  
**[SENSe<Ch>:]BWIDth[:RESolution]:SElect <Selectivity>**

Defines the selectivity of the IF filter for an unsegmented sweep. The value is also used for all segments of a segmented sweep, provided that separate selectivity setting is disabled

([SENSe<Ch>:]SEGMENT<Seg>:BWIDth[:RESolution]:SElect:CONTROL OFF).

**Note:** For the R&S ZNLE always NORMAL selectivity filters are used. Trying to set the selectivity will result in an execution error.

**Suffix:**

<Ch> Channel number

**Parameters:**

<Selectivity> NORMAL | MEDIUM | HIGH  
 NORMAL – IF filter with normal selectivity and short settling time.  
 MEDIUM – IF filter with steeper edges and longer settling time.  
 HIGH – IF filter with highest selectivity but longest settling time.  
 \*RST: NORMAL

**Example:** See [SENSe<Ch>:]SEGMENT<Seg>:BWIDth[:RESolution]:SElect:CONTROL

**Manual operation:** See "Selectivity" on page 307

**[SENSe:]CORRection:CDATA...**

The [SENSe:]CORRection:CDATA... commands read or write system error correction data.

**[SENSe<Ch>:]CORRection:CDATA <ErrorTerm>, <SourcePort>, <LoadPort>, <CorrectionData>...**

Writes or reads system error correction data for a specific channel <Ch>, calibration method ([SENSe<Ch>:]CORRection:COLLect:MEthod:DEFine), and port combination <SourcePort>, <LoadPort>. The setting command can be used to transfer user-defined correction data <CorrectionData> to the analyzer; the query returns the current correction data set. ASCII or block data can be transferred, depending on the selected data transfer format (FORMat[:DATA]).

The sweep must be stopped to transfer calibration data; see program example for [SENSe<Ch>:]CORRection:COLLect:SAVE:SElect:DEFault.

**Note:** This command affects the active calibration of channel no. <Ch> or the factory calibration (if no channel calibration is active). For the factory calibration, the query form is allowed only (no change of factory calibration data).

**Tip:** The analyzer provides a default calibration corresponding to a test setup which does not introduce any systematic errors; see [SENSe<Ch>:]CORRection:COLLect:SAVE:SElect:DEFault.

For an overview of calibration methods and error terms refer to [Chapter 9.5.1, "Calibration Types"](#), on page 249.

**Suffix:**

<Ch> Channel number of the calibrated channel.

**Parameters:**

<ErrorTerm>

String parameters describing the different error terms, depending on the current calibration method; see table below. Each term contains one complex value (real and imaginary part) for each sweep point. The parameters must be transferred in full length. The following strings are allowed:

**'DIRECTIVITY'**

Directivity at source port <SourcePort>

**'SRCMATCH'**

Source match at source port <SourcePort>

**'REFLTRACK'**

Reflection tracking at source port <SourcePort>

**'LOADMATCH'**

Load match at load port <LoadPort>

**'TRANSTRACK'**

Transmission tracking between source port <SourcePort> and load port <LoadPort>.

Range: The error terms are dimensionless complex numbers.

\*RST: n/a

<SourcePort>

Source port number

<LoadPort>

Load port number. If the error term is not related to the load port, a dummy number can be used; e.g. CORR:CDAT  
'REFLTRACK', 1, 0

<CorrectionData>

Correction data set (one complex number per sweep point) to be transferred to the analyzer either in ASCII or block data format, depending on the current [FORMat\[:DATA\]](#) setting. The correction data set is assigned to the specified channel, error term, source and load port.

This parameter must not be used for queries.

**Example:**

See [\[SENSe<Ch>:\]CORRection:COLLect:SAVE:SELected:DEFault](#).

The different calibration types of the analyzer provide the following error terms:

| Calibration type                                                      | Parameters in<br>[SENSe<Ch>:]CORRection:<br>COLLect:METhod:DEFine | Available error terms (depending on port numbers) |
|-----------------------------------------------------------------------|-------------------------------------------------------------------|---------------------------------------------------|
| One-port normalization (reflection) using an open or a short standard | REFL, RSHort                                                      | 'REFLTRACK'                                       |
| Full one port ("Refl OSM")                                            | FOPort                                                            | 'DIRECTIVITY', 'SRCMATCH', 'REFLTRACK'            |

|                        |         |                                                                   |
|------------------------|---------|-------------------------------------------------------------------|
| Two-port normalization | FRTRans | 'TRANSTRACK'                                                      |
| One path two port      | OPTPort | 'DIRECTIVITY', 'SRCMATCH', 'REFLTRACK', 'TRANSTRACK'              |
| TOSM                   | TOSM    | 'DIRECTIVITY', 'SRCMATCH', 'REFLTRACK', 'LOADMATCH', 'TRANSTRACK' |

### [SENSe:]CORRection:CKIT...

The [SENSe:]CORRection:CKIT... commands deal with calibration kits and cal kit data. The calibration kits are distinguished by their names (<CalKitName>), the optional labels (<label>) can be used to carry information about the calibration standard.

In order to handle several identical calibration kits with different serial numbers use the commands of "[SENSe:]CORRection:CKIT... with Labels" on page 831.

|                                                |     |
|------------------------------------------------|-----|
| [SENSe:]CORRection:CKIT:CATalog?.....          | 823 |
| [SENSe:]CORRection:CKIT:DELeTe.....            | 823 |
| [SENSe:]CORRection:CKIT:DMODE.....             | 824 |
| [SENSe:]CORRection:CKIT:LABel.....             | 824 |
| [SENSe:]CORRection:CKIT:SElect.....            | 825 |
| [SENSe:]CORRection:CKIT:STANdard:CATalog?..... | 825 |
| [SENSe:]CORRection:CKIT:STANdard:DATA?.....    | 826 |
| [SENSe:]CORRection:CKIT:<ConnType>:SElect..... | 826 |
| [SENSe:]CORRection:CKIT:<StandardType>.....    | 827 |

---

### [SENSe:]CORRection:CKIT:CATalog? [<ConnectorType>]

Returns a list of all cal kits for a given connector type or for all connector types.

#### Query parameters:

<ConnectorType> Name of the connector type (optional). Use [SENSe<Ch>:]CORRection:CONNection:CATalog? to query connector names.  
If omitted, the command returns the list of all cal kits.

**Example:** See [SENSe<Ch>:]CORRection:CONNection:CATalog?

**Usage:** Query only

**Manual operation:** See "Available Cal Kits" on page 471

---

### [SENSe:]CORRection:CKIT:DELeTe <CalKitName>

Deletes an imported or user-defined cal kit.

**Note:** It is not possible to modify or store predefined or ideal kits.

#### Setting parameters:

<CalKitName> String parameter containing an imported or user-defined calibration kit available on the analyzer.

**Example:** See [SENSe:]CORRection:CKIT:LABel

**Usage:** Setting only

**Manual operation:** See ["Add / Copy / Delete / Standards..."](#) on page 471

---

**[SENSe:]CORRection:CKIT:DMODE** <ConnectorType>, <CalKitName>, <KitLabel>, <Mode>

Sets/gets the delay mode for the related cal kit (identified by connector type, name and label), i.e allows to toggle between ZVR compatible and Keysight modelling (see ["Offset Parameters"](#) on page 474). Subsequent standard definitions interpret the specified <DelayParam> accordingly.

In "set direction", if a cal kit with the given connector type, name and label is not available on the analyzer, it is created automatically.

Cal kits that are not created/modified using [SENSe:]CORRection:CKIT:DMODE use the ZVR compatible modelling.

**Parameters:**

<ConnectorType> Name of the connector type. Use [SENSe<Ch>:]CORRection:CONNection:CATalog? to query connector names.

<CalKitName> String parameter containing the name of the calibration kit. See "Cal kit naming conventions " under [SENSe:]CORRection:CKIT:<ConnType>:LSElect.

<KitLabel> String parameter containing the label of the calibration kit, usually the serial number.

**Setting parameters:**

<Mode> DELay | ELENgth  
 DELay – Keysight modelling  
 ELENgth – ZVR compatible modelling

**Manual operation:** See ["Add / Copy / Delete / Standards..."](#) on page 471

---

**[SENSe:]CORRection:CKIT:LABel** <CalKitName>[, <KitLabel>]

Assigns a label to an imported or user-defined calibration kit.

**Parameters:**

<CalKitName> String parameter containing an imported or user-defined calibration kit available on the analyzer.

<KitLabel> String parameter containing the calibration kit label.



**Example:**

```
CORR:CKIT:FOP 'N 50 Ohm', 'New Kit 1', '',
0,4000000000,0,0,50,99,-2.3,0.22,0,0,0,0,0
Create a new cal kit "New Kit 1" and assign an open (f) standard
for the N 50 Ω connector type with specific properties.
CORR:CKIT:LAB 'New Kit 1', 'Test kit created
today'
Label the previously created kit.
CORR:CKIT:LAB? 'New Kit 1'
Check the label.
CORR:CKIT:DEL 'New Kit 1'
Delete the kit.
```

---

**[SENSe:]CORRection:CKIT:SElect** <ConnectorType>[, <CalKitName>]

Selects the calibration kit to be used, specifying its connector type and name (optional).

**Tip:** The command is suitable for connector types with arbitrary, user-defined names. For standard connector types you can use the command `[SENSe:]CORRection:CKIT:<ConnType>:SElect`.

**Parameters:**

<ConnectorType> Connector type, e.g. a user-defined connector type (string variable).

<CalKitName> String parameter containing the name of a calibration kit available on the analyzer.

**Example:**

```
MMEM:LOAD:CKIT 'C:\Users\Public\
Documents\Rohde-Schwarz\ZNL\
Calibration\Kits\New Kit 1.calkit'
Load the previously created cal kit file New Kit 1.calkit
from the default cal kit directory.
CORR:CKIT:SEL 'N 50 Ohm', 'New Kit 1'
Assign the imported kit to the N 50 Ω connector type, assuming
that the cal kit name stored in New Kit 1.calkit reads New
Kit 1.
```

**Manual operation:** See "Cal Kit" on page 464

---

**[SENSe:]CORRection:CKIT:STANdard:CATalog?** <CalKitName>

Returns a list of all standards in a given calibration kit.

**Query parameters:**

<CalKitName> Name of the cal kit. Use `[SENSe:]CORRection:CKIT:CATalog?` to query cal kit names.

**Example:** See `[SENSe<Ch>:]CORRection:CONNection:CATalog?`

**Usage:** Query only

---

**[SENSe:]CORRection:CKIT:STANdard:DATA?** <ConnectorType>, <CalKitName>, <KitLabel>, <StandardType>, <DelayMode>[, <Port1>[, <Port2>]]

Returns the data of the related calibration standard (identified by <ConnectorType>, <CalKitName>, <KitLabel> and <StandardType>) and - optionally - restricted to the given port(s).

The delay parameter is returned according to the selected <DelayMode>; see [Table 11-15](#).

**Query parameters:**

|                    |                                                                                                                                                                                                                                                                                                                                                                                                                                                                 |
|--------------------|-----------------------------------------------------------------------------------------------------------------------------------------------------------------------------------------------------------------------------------------------------------------------------------------------------------------------------------------------------------------------------------------------------------------------------------------------------------------|
| <ConnectorType>    | Name of the connector type. Use <a href="#">[SENSe&lt;Ch&gt;:]CORRection:CONNECTION:CATALog?</a> to query connector names.                                                                                                                                                                                                                                                                                                                                      |
| <CalKitName>       | String parameter containing the name of the calibration kit. See "Cal kit naming conventions " under <a href="#">[SENSe:]CORRection:CKIT:&lt;ConnType&gt;:LSElect</a> .                                                                                                                                                                                                                                                                                         |
| <KitLabel>         | String parameter containing the label of the calibration kit, usually the serial number.                                                                                                                                                                                                                                                                                                                                                                        |
| <StandardType>     | MMTHrough   MFTHrough   FFTHrough   MMLine   MMLine1   MMLine2   MMLine3   MFLine   MFLine1   MFLine2   MFLine3   FFLine   FFLine1   FFLine2   FFLine3   MMATten   MFATten   FFATten   MMSNetwork   MFSNetwork   FFSNetwork   MOPen   FOPen   MSHort   FSHort   MOShort   MOShort1   MOShort2   MOShort3   FOSHort   FOSHort1   FOSHort2   FOSHort3   MREFlect   FREFlect   MMTCh   FMTCh   MSMATCH   FSMATCH<br>Standard type; see <a href="#">Table 11-16</a> |
| <DelayMode>        | DELay   ELENgth<br>ELENgth (default) – ZVR compatible modelling<br>DELay – Keysight modelling                                                                                                                                                                                                                                                                                                                                                                   |
| <Port1>[, <Port2>] | Optional port restriction: one port number for one port standards, two port numbers for two port standards                                                                                                                                                                                                                                                                                                                                                      |
| <b>Usage:</b>      | Query only                                                                                                                                                                                                                                                                                                                                                                                                                                                      |

---

**[SENSe:]CORRection:CKIT:<ConnType>:SElect** <CalKitName>

Selects the calibration kit to be used for a specified connector type <ConnType>. The kit is identified by its name.

**Tip:** For connector types with arbitrary, user-defined names you can use the command [\[SENSe:\]CORRection:CKIT:SElect](#).

**Cal kit naming conventions**

Calibration kit names must be entered as string parameters. The string contains the cal kit name used in the calibration dialogs (e.g. "Calibration Presettings"); a "Ω" in the name must be replaced by Ohm, e.g.:

- NewKit1 denotes the user-defined calibration kit "NewKit1".

- N 50 Ohm Ideal Kit denotes the "N 50 Ω Ideal Kit".
- ZV-Z21 typical denotes the cal kit "ZV-Z21 typical".

**Suffix:**

<ConnType> Connector type, one of the following identifiers:  
 N50, N75 – N 50 Ω or N 75 Ω connectors  
 PC7, PC35, PC292 – PC 7, PC 3.5 or 2.92 mm connectors  
 USER<no> – user-defined connectors UserConn1, UserConn2  
 SMA – user-defined connector type SMA ...

**Parameters:**

<CalKitName> String parameter containing the name of a calibration kit available on the analyzer. See "Cal kit naming conventions " above.  
 \*RST: n/a (A \*RST does not change the assignment between connector types and calibration kits.)

**Example:**

```
MMEM:LOAD:CKIT 'C:\Users\Public\
Documents\Rohde-Schwarz\ZNL\
Calibration\Kits\New Kit 1.calkit'
Load the previously created cal kit file New Kit 1.calkit
from the default cal kit directory.
CORR:CKIT:N50:SEL 'New Kit 1'
Assign the imported kit to the N 50 Ω connector type, assuming
that the cal kit name stored in New Kit 1.calkit reads New
Kit 1.
```

**Manual operation:** See "[Add / Copy / Delete / Standards...](#)" on page 471

---

**[SENSe:]CORRection:CKIT:<StandardType>** <ConnType>, <CalKitName>, <StandardLabel>, <MinFreq>, <MaxFreq>[, <DelayParam>, <Loss>, <Z0>[, <C0>, <C1>, <C2>, <C3>, <L0>, <L1>, <L2>, <L3>[, OPEN | SHORT | MATCH | <Resistance>[, <Port1>[, <Port2>]]]]]

**[SENSe:]CORRection:CKIT:<StandardType>?** <ConnType>, <CalKitName>[, <Port1>[, <Port2>]]

Defines the parameters of a (possibly non-ideal) 1 port or 2-port calibration standard <StandardType> within a particular cal kit. Depending on the standard type, only a subset of the parameters is used; see [Table 11-14](#)

**Note**

As the query does not reflect the delay mode specified using [\[SENSe:\]CORRection:CKIT:DMODE](#), it is deprecated and only available for backward compatibility reasons. Use [\[SENSe:\]CORRection:CKIT:STANdard:DATA??](#) instead.

**Suffix:**

<StandardType> <string>  
Standard type  
For one-port standards, the first character denotes the gender, for transmission standards the first two characters denote the genders on both ends, e.g. MOPen for a male Open standard or FFThrougH for a Through standard with female connectors.  
For a complete list of standards, refer to [Table 11-16](#).

**Parameters:**

<StandardLabel> Additional string label for the standard, typically the standard's serial number

CalStandardProps Parameters <MinFreq>, ..., OPEN | SHORt | MATCh | <Resistance> define the properties of the calibration standard. See [Parameter list](#).  
**Note:** Sliding Match and Attenuation standards have only 2 parameters (<MinFreq>, <MaxFreq>). Through and Line standards only have 5 parameters (<MinFreq>, ..., <Z0>).

<Port1>, <Port2> Optional port restriction.  
For a one-port standard, the validity of the characterization can be restricted to a single port. For a two-port standard, it can be restricted to a port pair (specified using ascending port numbers).  
**Note:** with a port restriction, the defined standard becomes sexless. Hence, for each port (pair) there can be only one standard of a given type, i.e. :SENSe:CORRection:CKIT:MOP <ParameterList>, 1 and :SENSe:CORRection:CKIT:FOP <ParameterList>, 1 overwrite each other.

**Parameters for setting and query:**

<ConnType>, <CalkitName> String parameters uniquely identifying the cal kit to which the standard belongs.  
**Note:** If the specified cal kit does not exist, it is created with the specified calibration standard.

**Example:**

```
CORR:CKIT:FOP 'N 50 Ohm', 'New Kit 1', '',
0, 4000000000, 0, 0, 50, 99, -2.3, 0.22, 0, 0, 0, 0, 0
```

Define the properties of the Open (f) standard for a N 50 Ω connector type in cal kit "New Kit 1".

```
CORR:CKIT:FOP? 'N 50 Ohm'
```

Query the properties of the Open (f) standard for a N 50 Ω connector type in the active cal kit.

```
CORR:CKIT:FOP? 'N 50 Ohm', 'New Kit 1'
```

Query the properties of the Open (f) standard for a N 50 Ω connector type in cal kit "New Kit 1".

**Manual operation:** See ["One Port Standards / Two Port Standards"](#) on page 473

Table 11-14: Set command parameters

|                                                                                                                                                                                                                                                                                                                                               | One port standards                          |                |             |                                        |                             | Two port standards                     |               |             |  |
|-----------------------------------------------------------------------------------------------------------------------------------------------------------------------------------------------------------------------------------------------------------------------------------------------------------------------------------------------|---------------------------------------------|----------------|-------------|----------------------------------------|-----------------------------|----------------------------------------|---------------|-------------|--|
|                                                                                                                                                                                                                                                                                                                                               | Open                                        | (Offset) Short | Match       | Reflect                                | Sliding match               | Symmetric network                      | Through, Line | Attenuation |  |
| <ConnType>                                                                                                                                                                                                                                                                                                                                    | mandatory                                   |                |             |                                        |                             |                                        |               |             |  |
| <CalKitName>                                                                                                                                                                                                                                                                                                                                  | mandatory (and must not be an empty string) |                |             |                                        |                             |                                        |               |             |  |
| <StandardLabel>                                                                                                                                                                                                                                                                                                                               | mandatory (but can be an empty string)      |                |             |                                        |                             |                                        |               |             |  |
| <MinFreq>, <MaxFreq>                                                                                                                                                                                                                                                                                                                          | mandatory                                   |                |             |                                        |                             |                                        |               |             |  |
| <DelayParam>, <Loss>, <Z0>                                                                                                                                                                                                                                                                                                                    | mandatory                                   | mandatory      | mandatory   | mandatory                              | not used                    | mandatory                              |               | not used    |  |
| <C0>, <C1>, <C2>, <C3>                                                                                                                                                                                                                                                                                                                        | mandatory                                   | mandatory*     | mandatory*  | mandatory**                            |                             | mandatory**                            | not used      |             |  |
| <L0>, <L1>, <L2>, <L3>                                                                                                                                                                                                                                                                                                                        | mandatory*                                  | mandatory      | mandatory*  | mandatory**                            |                             | mandatory**                            |               |             |  |
| OPEN   SHORT   MATCH   <Resistance>                                                                                                                                                                                                                                                                                                           | optional***                                 | optional***    | optional*** | mandatory: OPEN   SHORT   <Resistance> |                             | mandatory: OPEN   SHORT   <Resistance> |               |             |  |
| <Port1>[, <Port2>]                                                                                                                                                                                                                                                                                                                            | optional: <Port 1>                          |                |             |                                        | optional: <Port 1>,<Port 2> |                                        |               |             |  |
| <p>* values are ignored during calibration</p> <p>** if OPEN is selected the residual inductance (L0,...,L3) are during calibration; if SHORT is selected the fringing capacitance (C0,...,C3) are during calibration</p> <p>*** must be provided if the definition is restricted to a single port. Values are ignored during calibration</p> |                                             |                |             |                                        |                             |                                        |               |             |  |

The parameters in the [SENSe<Ch>:]CORRection:CKIT:<StandardType>, [SENSe<Ch>:]CORRection:CKIT:<StandardType>:WLABels, and [SENSe<Ch>:]CORRection:CKIT:<ConnectorType>:<StandardType> commands have the following meaning:

Table 11-15: Parameter list

| Parameter      | Meaning                                                                                                         | Comment/Unit     |
|----------------|-----------------------------------------------------------------------------------------------------------------|------------------|
| '<ConnType>'   | Name of the connector type.<br>Use <code>SENSe1:CORRection:CONNECTION:CATalog?</code> to query connector names. | String parameter |
| '<CalKitName>' | Name of the calibration kit. Use <code>[SENSe:]CORRection:CKIT:CATalog?</code> to query cal kit names.          | String parameter |

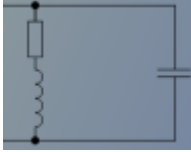
| Parameter                           | Meaning                                                                                                                                                                                                                                                                                                                                                                                                                                                                                                                                                                                                                                                                                                                      | Comment/Unit                                                                                                            |
|-------------------------------------|------------------------------------------------------------------------------------------------------------------------------------------------------------------------------------------------------------------------------------------------------------------------------------------------------------------------------------------------------------------------------------------------------------------------------------------------------------------------------------------------------------------------------------------------------------------------------------------------------------------------------------------------------------------------------------------------------------------------------|-------------------------------------------------------------------------------------------------------------------------|
| '<CalKitLabel>'                     | Label (e.g. the serial number) of the calibration kit; for . . . WLABel command only                                                                                                                                                                                                                                                                                                                                                                                                                                                                                                                                                                                                                                         | String parameter                                                                                                        |
| '<StandardLabel>'                   | Label (e.g. the serial number) of the standard                                                                                                                                                                                                                                                                                                                                                                                                                                                                                                                                                                                                                                                                               | String parameter                                                                                                        |
| <MinFreq>, <MaxFreq>                | Min./max. frequency for which the circuit model is valid                                                                                                                                                                                                                                                                                                                                                                                                                                                                                                                                                                                                                                                                     | Default unit is Hz                                                                                                      |
| <DelayParam>                        | Depending on the cal kit's model type (selected using [SENSe:]CORRection:CKIT:DMODE), this parameter is interpreted as: <ul style="list-style-type: none"> <li>• delay [s] for Keysight modeling</li> <li>• el. length [m] for ZVR compatible modeling</li> </ul> Cal kits that are not created/modified using [SENSe:]CORRection:CKIT:DMODE use the ZVR compatible modeling.                                                                                                                                                                                                                                                                                                                                                |                                                                                                                         |
| <Loss>                              | Loss (offset parameter) of the standard                                                                                                                                                                                                                                                                                                                                                                                                                                                                                                                                                                                                                                                                                      | Must be specified without unit (implicit unit is dB)                                                                    |
| <Z0>                                | Reference impedance (no unit)                                                                                                                                                                                                                                                                                                                                                                                                                                                                                                                                                                                                                                                                                                | Must be specified without unit (implicit unit is $\Omega$ )                                                             |
| <C0>, ..., <C3>                     | Polynomial coefficients for the fringing capacitance of the standard (load parameter)                                                                                                                                                                                                                                                                                                                                                                                                                                                                                                                                                                                                                                        | Must be specified without unit: implicit unit of <C> is fF / (GHz) <sup>i</sup>                                         |
| <L0>, ..., <L3>                     | Polynomial coefficients for the residual inductance of the standard (load parameter)                                                                                                                                                                                                                                                                                                                                                                                                                                                                                                                                                                                                                                         | Must be specified without unit: implicit unit of <L> is pH / (GHz) <sup>i</sup>                                         |
| OPEN   SHORT   MATCH   <Resistance> | A load circuit model generally consists of a capacitance (modeled by <C0>, ..., <C3>), connected in parallel to an inductance (modeled by <L0>, ..., <L3>) and a resistance, both connected in series.<br>OPEN   SHORT   MATCH indicates a simplified modeling as an Open or Short or Match standard. <ul style="list-style-type: none"> <li>• OPEN: the resistance is infinite so that the standard behaves like a capacitor (no inductance)</li> <li>• SHORT: the resistance is zero so that the standard behaves like an inductance (no capacitance)</li> <li>• MATCH: the standard behaves like a match (no inductance, no capacitance, resistance Z0)</li> </ul> <Resistance> indicates the general load circuit model. | <br>Character data   numeric value |
| <Port1>, <Port2>                    | Optional port restriction: one port number for one-port standards, two port numbers for two-port standards                                                                                                                                                                                                                                                                                                                                                                                                                                                                                                                                                                                                                   | Integer values                                                                                                          |

The different standard types are defined by the following parameters. Port restrictions are indicated in brackets:

**Table 11-16: Standard types and their parameters**

| <std_type>                                            | Meaning                                                                                                                    |
|-------------------------------------------------------|----------------------------------------------------------------------------------------------------------------------------|
| MOPen   FOPen                                         | Open: male (m) or female (f)                                                                                               |
| MSHort   FSHort                                       | Short: m or f                                                                                                              |
| OShort[<1 2 3>]   MOShort[<1 2 3>]   FOShort[<1 2 3>] | Offset short: sexless, m or f (three standards each)<br>For user-defined connector types only.<br>Suffix 1 can be omitted. |
| MMTch   FMTCh                                         | Match: m or f                                                                                                              |

| <std_type>                                                                       | Meaning                                                                    |
|----------------------------------------------------------------------------------|----------------------------------------------------------------------------|
| MSMatch   FSMatch                                                                | Sliding match: m or f                                                      |
| MREFlect   FRElect                                                               | Reflect: m or f                                                            |
| MMTHrough   MFTHrough   FFTHrough                                                | Through: m-m or m-f or f-f                                                 |
| MMLine[<1 2 3>]   MFLine[<1 2 3>]   FFLine[<1 2 3>]<br>MMLine[<1 2 3>](P2P3) ... | Line: m-m or m-f or f-f (three standards each)<br>Suffix 1 can be omitted. |
| MMATten   MFATten   FFATten                                                      | Attenuation: m-m or m-f or f-f                                             |
| MMSNetwork   MFSNetwork   FFSNetwork                                             | Symmetric network: m-m or m-f or f-f                                       |

### [SENSe:]CORRection:CKIT... with Labels

The following [SENSe:]CORRection:CKIT... commands identify the calibration kit to be used by a combination of its <CalkitName> and <CalkitLabel>. Typically, the serial number of the calibration kit serves as a calibration kit label. Due to their different labels, the analyzer can handle several calibration kits with identical names.

|                                                             |     |
|-------------------------------------------------------------|-----|
| [SENSe:]CORRection:CKIT:LCATalog?                           | 831 |
| [SENSe:]CORRection:CKIT:LDElete                             | 831 |
| [SENSe:]CORRection:CKIT:LLABel                              | 832 |
| [SENSe:]CORRection:CKIT:LSElect                             | 833 |
| [SENSe:]CORRection:CKIT:STANdard:LCATalog?                  | 833 |
| [SENSe:]CORRection:CKIT:<ConnType>:LSElect                  | 833 |
| [SENSe:]CORRection:CKIT:<StandardType>:WLABel               | 834 |
| [SENSe:]CORRection:CKIT:<OnePortStandardType>:WLABel:SDATa? | 835 |
| [SENSe:]CORRection:CKIT:<TwoPortStandard>:WLABel:SDATa?     | 835 |

---

### [SENSe:]CORRection:CKIT:LCATalog? [<ConnectorType>]

Returns a list of all cal kits and their labels for a given connector type or for all connector types.

#### Query parameters:

<ConnectorType> Name of the connector type. Use [SENSe<Ch>:]CORRection:CONNection:CATalog? to query connector names.  
If omitted, the command returns the list of all cal kits and labels.

**Example:** See [SENSe<Ch>:]CORRection:CONNection:CATalog?

**Usage:** Query only

---

### [SENSe:]CORRection:CKIT:LDElete <CalKitName>, <KitLabel>

Deletes an imported or user-defined cal kit which is identified by its cal kit name and label.

**Note:** It is not possible to modify or store predefined or ideal kits.

**Setting parameters:**

<CalKitName> String parameter containing an imported or user-defined calibration kit available on the analyzer.

<KitLabel> String parameter containing the label of an imported or user-defined calibration kit available on the analyzer.

**Example:** See [SENSe:]CORRection:CKIT:LLABel

**Usage:** Setting only

**[SENSe:]CORRection:CKIT:LLABel <CalKitName>, <KitLabel>[, <NewKitLabel>]**

Assigns a calibration kit label to an imported or user-defined calibration kit or renames an existing calibration kit label.

**Parameters:**

<CalKitName> String parameter containing an imported or user-defined calibration kit available on the analyzer.

<KitLabel> String parameter containing the current calibration kit label.

<NewKitLabel> String parameter containing the new calibration kit label.

**Example:** CORR:CKIT:FOP:WLAB 'N 50 Ohm', 'New Kit 1', 'Test kit created today', '', 0, 4000000000, 0, 0, 50, 99, -2.3, 0.22, 0, 0, 0, 0, 0  
Create a new cal kit "New Kit 1" labelled "Test kit created today" and assign an open (f) standard for the N 50 Ω connector type with specific properties.

```
CORR:CKIT:LLAB 'New Kit 1', 'Test kit created today', '2012-05-25'
```

Change the label of the previously created kit.

```
CORR:CKIT:LLAB? 'New Kit 1', '2012-05-25'
```

Check the label.

```
MMEMemory:STORe:CKIT:
```

```
WLABel 'New Kit 1', '2012-05-25', 'C:
```

```
\Users\Public\Documents
```

```
\Rohde-Schwarz\ZNL\Calibration\Kits\New Kit 1 (2012-05-25).calkit'
```

Store the data for the labelled cal kit to the cal kit file

```
New Kit 1 (2012-05-25).calkit.
```

```
CORR:CKIT:LDEL 'New Kit 1', '2012-05-25'
```

Delete the kit. from the internal memory.

```
MMEMemory:LOAD:CKIT 'C:\Users\Public\Documents
```

```
\Rohde-Schwarz\ZNL\Calibration\Kits\New Kit 1 (2012-05-25).calkit'
```

Re-load the kit.



---

**[SENSe:]CORRection:CKIT:LSElect** <ConnectorType>, <CalKitName>, <KitLabel>

Selects the calibration kit to be used, specifying its connector type, name, and label.

**Tip:** The command is suitable for connector types with arbitrary, user-defined names. For standard connector types you can use the command `[SENSe:]CORRection:CKIT:<ConnType>:LSElect`.

**Parameters:**

<ConnectorType> Connector type, e.g. a user-defined connector type (string variable).

<CalKitName> String parameter containing the name of a calibration kit available on the analyzer.

<KitLabel> String parameter containing the label of a calibration kit available on the analyzer.

**Example:**

```
MMEM:LOAD:CKIT 'C:\Users\Public\
Documents\Rohde-Schwarz\ZNL\
Calibration\Kits\New Kit 1 (123456).calkit'
Load the previously created cal kit file
New Kit 1 (123456).calkit from the default cal kit directory.
CORR:CKIT:LSEL 'N 50 Ohm', 'New Kit 1',
'123456'
Assign the imported kit to the N 50 Ω connector type, assuming
that the cal kit name stored in New Kit 1 (123456).calkit
reads New Kit 1 and that its label reads 123456.
```

---

**[SENSe:]CORRection:CKIT:STANdard:LCATalog?** <CalKitName>, <KitLabel>

Returns a list of all standards in a given calibration kit.

**Query parameters:**

<CalKitName> Name of the cal kit. Use `[SENSe:]CORRection:CKIT:LCATalog?` to query cal kit names and labels.

<KitLabel> Label of the cal kit.

**Example:** See `[SENSe<Ch>:]CORRection:CONNection:CATalog?`

**Usage:** Query only

---

**[SENSe:]CORRection:CKIT:<ConnType>:LSElect** <CalKitName>, <Label>

Selects the calibration kit to be used for a specified connector type <ConnType>. The kit is identified by its name and label.

**Tip:** For connector types with arbitrary, user-defined names and labels you can use the command `[SENSe:]CORRection:CKIT:LSElect`.

**Suffix:**

<ConnType> Connector type, one of the following identifiers:  
 N50, N75 – N 50  $\Omega$  or N 75  $\Omega$  connectors  
 PC7, PC35, PC292 – PC 7, PC 3.5 or 2.92 mm connectors  
 USER<no> – user-defined connectors UserConn1, UserConn2  
 SMA – user-defined connector type SMA ...

**Parameters:**

<CalKitName> String parameter containing the name of a calibration kit available on the analyzer. See "Cal kit naming conventions " under [\[SENSe:\]CORRection:CKIT:<ConnType>:LSElect](#).

\*RST: n/a (A \*RST does not change the assignment between connector types and calibration kits.)

<CalKitLabel> String parameter containing the label of a calibration kit available on the analyzer, usually the serial number.

\*RST: n/a (A \*RST does not change the assignment between connector types and calibration kits.)

**Example:**

```
MMEM:LOAD:CKIT 'C:\Users\Public
\Documents\Rohde-Schwarz
\Vna\Calibration\Kits\New Kit 1
(123456).calkit'
```

Load the previously created cal kit file

New Kit 1 (123456).calkit from the default cal kit directory.

```
CORR:CKIT:N50:LSEL 'New Kit 1', '123456'
```

Assign the imported kit to the N 50  $\Omega$  connector type, assuming that the cal kit name stored in New Kit 1 (123456).calkit reads New Kit 1 and that its label reads 123456.

**Manual operation:** See ["Add / Copy / Delete / Standards..."](#) on page 471

---

**[SENSe:]CORRection:CKIT:<StandardType>:WLABEL** <ConnType>, <CalKitName>, <CalKitLabel>, <StandardLabel>, <MinFreq>, <MaxFreq>, <DelayParam>, <Loss>, <Z0>, <C0>, <C1>, <C2>, <C3>, <L0>, <L1>, <L2>, <L3>, OPEN | SHORT | MATCH | <Resistance>[, <Port1>[, <Port2>]]

**[SENSe:]CORRection:CKIT:<StandardType>:WLABEL?** <ConnType>[, <CalKitName>[, <CalKitLabel>[, <Port1>[, <Port2>]]]]

Defines the parameters of a non-ideal 1 port or 2-port calibration standard <StandardType>, where a particular cal kit can be addressed by name **and label**.

Apart from the additional <CalKitLabel> parameter, the syntax and semantics of this command is identical to [Standard types and their parameters](#).

**Example:**

```
CORR:CKIT:FOP:WLAB 'N 50 Ohm', 'New Kit
1', '123456', '',
0, 4000000000, 0, 0, 50, 99, -2.3, 0.22, 0, 0, 0, 0, 0
Define the properties of the Open (f) standard for a N 50 Ω con-
nector type in the calibration kit "New Kit 1" labelled "123456".
CORR:CKIT:FOP:WLAB? 'N 50 Ohm', 'New Kit 1',
'123456'
Query the properties of the Open (f) standard for a N 50 Ω con-
nector type in the calibration kit.
```

**Manual operation:** See ["Add / Copy... / Delete / View / Modify..."](#) on page 473

---

**[SENSe:]CORRection:CKIT:<OnePortStandardType>:WLABel:SDATa?**  
 <ConnectorType>, <CalKitName>[, <CalKitLabel>[, <PhysPort>]]

Reads the S-parameter data for a particular **1-port** cal kit standard previously loaded from Touchstone file using [MMEMory:LOAD:CKIT:SDATa](#) or [MMEMory:LOAD:CKIT:SDATa:WLABel](#).

The cal kit is identified by its name and label.

**Query parameters:**

<OnePort StandardType> MOPen | FOPen | MSHort | FSHort | MOShort | MOShort1 | MOShort2 | MOShort3 | FOSHort | FOSHort1 | FOSHort2 | FOSHort3 | MREFlect | FRElect | MMTCh | FMTCh | MSMatch | FSMatch

Standard type.

For more information see [Table 11-16](#).

<ConnectorType>, <CalKitName>, <CalKitLabel> Together with <StandardType> these parameters fully identify the related standard (see [Parameter list](#)).

<PhysPort> Number of the physical port for which the S-parameter data is valid. Can be omitted if the data are valid for all ports.

**Usage:** Query only

---

**[SENSe:]CORRection:CKIT:<TwoPortStandard>:WLABel:SDATa?**  
 <ConnectorType>, <CalKitName>[, <CalKitLabel>[, <SPParameter>, <PhysPort1>, <PhysPort2>]]

Reads the S-parameter data for a particular **2-port** cal kit standard previously loaded from Touchstone file using [MMEMory:LOAD:CKIT:SDATa](#) or [MMEMory:LOAD:CKIT:SDATa:WLABel](#).

The cal kit is identified by its name and label.

**Query parameters:**

|                                                    |                                                                                                                                                                                                                                                                                                         |
|----------------------------------------------------|---------------------------------------------------------------------------------------------------------------------------------------------------------------------------------------------------------------------------------------------------------------------------------------------------------|
| <TwoPortStandard>                                  | MMTHrough   MFTHrough   FFTHrough   MMLine   MMLine1   MMLine2   MMLine3   MFLine   MFLine1   MFLine2   MFLine3   FFLine   FFLine1   FFLine2   FFLine3   MMATten   MFATten   FFATten   MMSNetwork   MFSNetwork   FFSNetwork<br>Standard type.<br>For more information see <a href="#">Table 11-16</a> . |
| <ConnectorType>,<br><CalKitName>,<br><CalKitLabel> | Together with <StandardType> these parameters fully identify the related standard (see <a href="#">Parameter list</a> ).                                                                                                                                                                                |
| <SParameter>                                       | S11   S12   S21   S22<br>S-parameter of the 2-port standard.                                                                                                                                                                                                                                            |
| <PhysPort1>,<br><PhysPort2>                        | Numbers of the physical ports for which the S-parameter data is valid. Can be omitted if the data are valid for all port pairs.                                                                                                                                                                         |
| <b>Usage:</b>                                      | Query only                                                                                                                                                                                                                                                                                              |

**[SENSe:]CORRection...**

The [SENSe:]CORRection... commands control the system error correction.

|                                                                   |     |
|-------------------------------------------------------------------|-----|
| [SENSe:]CORRection:COLLect:AUTO:CKIT.....                         | 837 |
| [SENSe:]CORRection:COLLect:AUTO:CKIT:PASSword.....                | 838 |
| [SENSe:]CORRection:COLLect:AUTO:CKIT:PORTs.....                   | 839 |
| [SENSe:]CORRection:COLLect:AUTO:CKIT:PORTs:ADD.....               | 840 |
| [SENSe:]CORRection:COLLect:AUTO:PORTs:CONNectiOn?.....            | 840 |
| [SENSe:]CORRection:COLLect:AVERAge.....                           | 841 |
| [SENSe:]CORRection:COLLect:CHANnels:ALL.....                      | 841 |
| [SENSe:]CORRection:COLLect:CHANnels:MCTypes.....                  | 841 |
| [SENSe:]CORRection:COLLect:FIXTure:LMPParameter[:STATe].....      | 843 |
| [SENSe:]CORRection:COLLect:FIXTure:LMPParameter:LOSS[:STATe]..... | 843 |
| [SENSe<Ch>:]CORRection[:STATe].....                               | 843 |
| [SENSe<Ch>:]CORRection:COLLect[:ACQuire]:SELeCted.....            | 844 |
| [SENSe<Ch>:]CORRection:COLLect:AUTO.....                          | 845 |
| [SENSe<Ch>:]CORRection:COLLect:AUTO:CONFIgure.....                | 846 |
| [SENSe<Ch>:]CORRection:COLLect:AUTO:PORTs.....                    | 848 |
| [SENSe<Ch>:]CORRection:COLLect:AUTO:PORTs:TYPE.....               | 849 |
| [SENSe<Ch>:]CORRection:COLLect:AUTO:TYPE.....                     | 850 |
| [SENSe<Ch>:]CORRection:COLLect:CKIT:INSTall.....                  | 852 |
| [SENSe<Ch>:]CORRection:COLLect:CKIT:LOAD.....                     | 852 |
| [SENSe<Ch>:]CORRection:COLLect:CKIT:PORT<PhyPt>?.....             | 852 |
| [SENSe<Ch>:]CORRection:COLLect:CONNectiOn<PhyPt>.....             | 853 |
| [SENSe<Ch>:]CORRection:COLLect:CONNectiOn:GENDeRs.....            | 854 |
| [SENSe<Ch>:]CORRection:COLLect:CONNectiOn:PORTs.....              | 854 |
| [SENSe<Ch>:]CORRection:COLLect:DELeTe.....                        | 855 |
| [SENSe<Ch>:]CORRection:COLLect:DISCard.....                       | 855 |
| [SENSe<Ch>:]CORRection:COLLect:FIXTure[:ACQuire].....             | 856 |
| [SENSe<Ch>:]CORRection:COLLect:FIXTure:EXPort.....                | 857 |
| [SENSe<Ch>:]CORRection:COLLect:FIXTure:IMPorT.....                | 857 |

|                                                                |     |
|----------------------------------------------------------------|-----|
| [SENSe<Ch>:]CORRection:COLLect:FIXTure:SAVE.....               | 858 |
| [SENSe<Ch>:]CORRection:COLLect:FIXTure:START.....              | 858 |
| [SENSe<Ch>:]CORRection:COLLect:LOAD:SElected.....              | 859 |
| [SENSe<Ch>:]CORRection:COLLect:METHod:DEFine.....              | 860 |
| [SENSe<Ch>:]CORRection:DELeTe.....                             | 861 |
| [SENSe<Ch>:]CORRection:COLLect:SAVE:SElected:DEFault.....      | 861 |
| [SENSe<Ch>:]CORRection:COLLect:SAVE:SElected[:DUMMy].....      | 862 |
| [SENSe<Ch>:]CORRection:COLLect:SCONnection<PhyPt>.....         | 863 |
| [SENSe<Ch>:]CORRection:CONNectioN.....                         | 864 |
| [SENSe<Ch>:]CORRection:CONNectioN:CATalog?.....                | 864 |
| [SENSe<Ch>:]CORRection:CONNectioN:DELeTe.....                  | 865 |
| [SENSe<Ch>:]CORRection:DATA:PARAmeter<Sfk>?.....               | 866 |
| [SENSe<Ch>:]CORRection:DATA:PARAmeter:COUNT?.....              | 867 |
| [SENSe<Ch>:]CORRection:DATE?.....                              | 868 |
| [SENSe<Ch>:]CORRection:EDELay:AUTO.....                        | 868 |
| [SENSe<Ch>:]CORRection:EDELay<PhyPt>:DIElectric.....           | 869 |
| [SENSe<Ch>:]CORRection:EDELay<PhyPt>:DISTance.....             | 869 |
| [SENSe<Ch>:]CORRection:EDELay<PhyPt>:ELENgth.....              | 869 |
| [SENSe<Ch>:]CORRection:EDELay<PhyPt>[:TIME].....               | 870 |
| [SENSe:]CORRection:EDELay:VNETwork.....                        | 870 |
| [SENSe<Ch>:]CORRection:EWAVe[:STATe].....                      | 871 |
| [SENSe<Ch>:]CORRection:LOSS<PhyPt>.....                        | 871 |
| [SENSe<Ch>:]CORRection:LOSS<PhyPt>:SECond.....                 | 871 |
| [SENSe<Ch>:]CORRection:LOSS:AUTO.....                          | 871 |
| [SENSe<Ch>:]CORRection:LOSS<PhyPt>:FREQUency.....              | 872 |
| [SENSe<Ch>:]CORRection:LOSS<PhyPt>:SECond:FREQUency.....       | 872 |
| [SENSe<Ch>:]CORRection:LOSS<PhyPt>:OFFSet.....                 | 872 |
| [SENSe<Ch>:]CORRection:LOSS<PhyPt>:SECond:STATe.....           | 872 |
| [SENSe<Ch>:]CORRection:OFFSet<PhyPt>[:STATe].....              | 873 |
| [SENSe<Ch>:]CORRection:OFFSet<PhyPt>:COMPensation[:STATe]..... | 873 |
| [SENSe<Ch>:]CORRection:OFFSet<PhyPt>:DFComp[:STATe]?.....      | 874 |
| [SENSe<Ch>:]CORRection:STIMulus?.....                          | 874 |
| [SENSe<Chn>:]CORRection:SSTate?.....                           | 875 |

---

### [SENSe:]CORRection:COLLect:AUTO:CKIT <Characterization>

Generates a characterization (cal kit file) with the specified name containing the cal kit data of the active calibration unit (selected via `SYSTem:COMMunicate:RDEvice:AKAL:ADDReSS`). The cal kit file can be saved to a directory on the analyzer, to the calibration unit's internal (flash) memory or to an SD card inserted at the calibration unit (if available).

**Note** that this command can only be executed if the number of cal unit ports is less or equal to the number of test ports. Furthermore the command assumes the "canonical" assignment of cal unit ports to test ports: cal unit port 1 assigned to test port 1, cal unit port 2 assigned to test port 2 etc. The new command `[SENSe:]CORRection:COLLect:AUTO:CKIT:PORTs` allows for flexible assignments.

#### Setting parameters:

<Characterization> Location of the created characterization / cal kit file (string parameter, extension \*.calkit):

If a path is specified, the file is saved to the analyzer's hard disk. The default directory (`MMEMory:CDIRectory`) is **not** used.

If only the file name is specified, the file is saved to the calibration unit's internal (flash) memory. The factory calibration data on the unit is not overwritten.

If the file name is prefixed by "SD:", the file is saved to the SD card inserted at the calibration unit (if available/accessible).

**Example:**

```
CORR:COLL:AUTO:CKIT 'AutoCalChar'
```

Generate a cal kit file `AutoCalChar.calkit` for the active calibration unit and store it in the calibration unit.

```
SENSe:CORRection:COLLect:AUTO:CKIT 'SD:test1'
```

Generate a cal kit file `test1.calkit` for the active calibration unit and store it in the calibration unit.

**Usage:**

Setting only

**Manual operation:** See "[File name / Comment \(Optional\)](#)" on page 479

**[SENSe:]CORRection:COLLect:AUTO:CKIT:PASSword <Password>**

Enters a password to enable a single password-protected action in the automatic calibration or in the characterization wizard. If password protection has been activated manually in the "Characterize Cal Unit" dialog, the password is required for any single execution of one of the following commands, provided that a cal kit (characterization) file different from the active characterization is specified:

```
[SENSe]:CORRection:COLLect:AUTO
```

```
[SENSe]:CORRection:COLLect:AUTO:CKIT
```

```
[SENSe]:CORRection:COLLect:AUTO:PORTs
```

```
[SENSe]:CORRection:COLLect:AUTO:PORTs:TYPE
```

```
[SENSe]:CORRection:COLLect:AUTO:TYPE
```

**Tip:** You have to send `[SENSe:]CORRection:COLLect:AUTO:CKIT:PASSword` repeatedly if your command script uses several password-protected commands. You do not need a password to perform automatic calibrations using the active cal unit characterization.

**Setting parameters:**

<Password> Password (string parameter), as defined in manual control.

**Example:**

```
SENSe:CORRection:COLLect:AUTO:CKIT:PASSword
'My_password'
```

Enter a password `My_password` (assuming that password protection has been activated manually).

```
SENSe:CORRection:COLLect:AUTO '', 1, 2
```

Perform an automatic 2-port calibration at test ports 1 and 2 using the calibration unit's default calibration kit file and automatic port assignment.

```
SENSe:CORRection:COLLect:AUTO:CKIT:PASSword
'My_password'
```

Re-enter the password.

```
SENSe:CORRection:COLLect:AUTO '', 1, 2
```

Repeat the calibration.

**Usage:** Setting only

**Manual operation:** See "[Authentication](#)" on page 476

---

**[SENSe:]CORRection:COLLect:AUTO:CKIT:PORTs** <Characterization>, <TestPort1>, <CalUnitPort1>[, <TestPort2>...]

Generates a characterization (cal kit file) with the specified name containing the cal kit data of the active calibration unit (`SYSTem:COMMunicate:RDEvice:AKAL:ADDResS`). The cal kit file can be saved to a directory on the analyzer, to the calibration unit's internal (flash) memory or to an SD card inserted at the calibration unit (if available).

Similar logic as `[SENSe:]CORRection:COLLect:AUTO:CKIT`, but with flexible port assignment.

**Setting parameters:**

<Characterization> Location of the created characterization / cal kit file (string parameter, extension \*.calkit):  
 If a path is specified, the file is saved to the analyzer's hard disk. The default directory (`MMEMory:CDIRectory`) is **not** used.  
 If only the file name is specified, the file is saved to the calibration unit's internal (flash) memory. The factory calibration data on the unit is not overwritten.  
 If the file name is prefixed by "SD:", the file is saved to the SD card inserted at the calibration unit (if available/accessible).

<TestPort1> Number of first test port.

<CalUnitPort1> Number of the calibration unit port to whom the first test port (<TestPort1>) is assigned.

<TestPort2> Number of second test port...

**Usage:** Setting only

**Manual operation:** See "[Test Port Assignment](#)" on page 478

---

```
[SENSe:]CORRection:COLLect:AUTO:CKIT:PORTs:ADD <Characterization>,
 <TestPort1>, <CalUnitPort1>[, <TestPort2>]...
```

Extends or modifies an *existing* characterization of the active calibration unit (`SYSTem:COMMunicate:RDEvice:AKAL:ADDRESS`).

This functionality is not available at the GUI.

#### Setting parameters:

<Characterization> Location of an existing characterization (e.g. created using `[SENSe:]CORRection:COLLect:AUTO:CKIT:PORTs`).

- A VNA cal kit file name `*.calkit` without path refers to a specific cal kit file stored in the internal memory of the active calibration unit.
- A VNA cal kit file name without path but prefixed with "SD:" refers to a specific cal kit file stored on the SD card inserted at the active calibration unit.
- A VNA cal kit file name `*.calkit` with path refers to a specific cal kit file stored in an arbitrary directory on the analyzer.

<TestPort1> Number of first test port.

<CalUnitPort1> Number of the calibration unit port, to whom test port <TestPort1> is assigned.

<TestPort2> Number of the second test port ...

#### Example:

Prerequisite:

```
SYSTem:COMMunicate:RDEvice:AKAL:ADDRESS
'MyCalU'
```

Sets 'MyCalU' as the active calibration unit.

```
SYSTem:COMMunicate:RDEvice:AKAL:PORTs? 'abc'
```

Queries the ports of characterization 'abc'; returns something like '3,N 50 Ohm,MALE,4,N 50 Ohm,MALE'. In particular, calibration unit ports 1 and 2 are not yet characterized.

```
SENSe:CORRection:COLLect:AUTO:CKIT:PORTs:ADD
'abc', 1, 2
```

Extend characterization 'abc' with test port 1 assigned to port 2 of the cal unit.

```
SYSTem:COMMunicate:RDEvice:AKAL:PORTs? 'abc'
```

Now returns something like '2,N 50 Ohm,MALE,3,N 50 Ohm,MALE,4,N 50 Ohm,MALE'.

```
SENSe:CORRection:COLLect:AUTO:CKIT:PORTs:ADD
'abc', 1, 2
```

Repeat characterization of test port 2, e.g. because the connection cable wasn't fastened correctly ...

**Usage:** Setting only

---

#### [SENSe:]CORRection:COLLect:AUTO:PORTs:CONNECTION?

Returns the assignment between the physical analyzer ports and the ports of the connected automatic calibration unit.



**Example:** `CORR:COLL:AUTO:PORT '', 1, 2`  
 Perform an automatic 1-port calibration at analyzer port 1, using the calibration unit's default calibration kit file and port 2 of the cal unit.

`CORR:COLL:AUTO:PORT:CONN?`

Query the actual port assignment. If the cal unit is properly connected according to the previous command, the response is 1,2,2,0. A zero means that the corresponding analyzer port is not connected to any port of the calibration unit.

**Usage:** Query only

**Manual operation:** See "[Detect Port Assignment](#)" on page 458

#### **[SENSe:]CORRection:COLLect:AVERage <Average>**

Activates automatic averaging, which means that the VNA may perform multiple calibration sweeps and apply averaging to reduce trace noise. In contrast to manual averaging (see `[SENSe<Ch>:]AVERage[:STATe]`) the number of calibration sweeps is calculated automatically.

**Parameters:**

<Average> AUTO | MANual

**Manual operation:** See "[Auto Averaging](#)" on page 142

#### **[SENSe:]CORRection:COLLect:CHANnels:ALL <Boolean>**

Enables calibration of all channels in the active channel setup. The command is valid for the following calibration methods:

- Manual system error correction
- Automatic system error correction (cal unit)

**Parameters:**

<Boolean> ON – calibrate all channels.  
 OFF – calibrate the active channel only.

**Example:** See `[SENSe<Ch>:]CORRection:COLLect:SAVE:SElected[:DUMMy]`

**Manual operation:** See "[Calibrate all Channels](#)" on page 462

#### **[SENSe:]CORRection:COLLect:CHANnels:MCTypes <Boolean>**

Toggles the **Multiple Calibration TTypes** mode that allows you to calibrate a subset of the available channels using channel-specific ports and calibration types (see [Chapter 9.5.6, "Parallel Calibration of Multiple Channels"](#), on page 265).

Enable the MCTYPES mode before defining the calibrations to be performed using `[SENSe<Ch>:]CORRection:COLLect:METhod:DEFine`. Disable the MCTYPES mode after the calibrations were saved using `[SENSe<Ch>:]CORRection:COLLect:SAVE:SELected[:DUMMy]`. The latter must be called only *once*, with <Ch> referring to one of the channels to be calibrated (see the example below).

**Parameters:**

<Boolean>

**Example:**

Suppose that there are 3 channels in the current channel setup and you want to calibrate channels 1 and 2. For channel 1, you want to perform a Reflection Normalization (Short) on ports 1 and 2, for channel 2 an OSM calibration on port 2. This calibration requires measuring standards as shown in the table below. Proceed as follows:

```
:CORRection:COLLect:CHANnels:MCTYPES ON
```

Activate the MCTYPES mode.

```
:SENSe1:CORRection:COLLect:METhod:DEFine
```

```
'Parser Test SFK Ch1', RSHort, 1, 2
```

```
:SENSe2:CORRection:COLLect:METhod:DEFine
```

```
'Parser Test SFK Ch2', FOPort, 2
```

Declare the calibrations to be performed. Then connect the Short standard to port 1

```
:SENSe:CORRection:COLLect:ACQuire:SELected
SHORT, 1
```

Acquire calibration data for the short on port 1 (needed for calibration in channel 1). Then connect the Open standard to port 2.

```
:SENSe:CORRection:COLLect:ACQuire:SELected
OPEN, 2
```

Acquire calibration data for the open on port 2 (needed for calibration in channel 2). Then connect the Short standard to port 2.

```
:SENSe:CORRection:COLLect:ACQuire:SELected
SHORT, 2
```

Acquire calibration data for short on port 2 (needed for calibrations in channel 1 and 2). Then connect the Match standard to port 2.

```
:SENSe:CORRection:COLLect:ACQuire:SELected
MATCH, 2
```

Acquire calibration data for match on port 2 (needed for calibration in channel 2).

```
:SENSe1:CORRection:COLLect:SAVE:SELected
```

Complete all calibrations. This command is required only once and has to address one of the calibrated channels (channel 1 or 2 in this example).

```
:CORRection:COLLect:CHANnels:MCTYPES OFF
```

Deactivate the MCTYPES mode. Recommended for compatibility with manual operation.

|                                                                          | Port 1 | Port 2             |
|--------------------------------------------------------------------------|--------|--------------------|
| <b>Channel 1</b><br>Reflection Normalization(Short)<br>for ports 1 and 2 | Short  | Short              |
| <b>Channel 2</b><br>OSM for port 1                                       | -      | Open, Short, Match |

---

**[SENSe:]CORRection:COLLect:FIXTure:LMPParameter[:STATe]** <Boolean>

Selects an Auto Length (and Loss) calculation or a Direct Compensation.

**Parameters:**

<Boolean>            1 - Auto Length (and Loss), depending on the last  
[SENSe<Ch>:]CORRection:COLLect:FIXTure:  
LMPParameter:LOSS[:STATe] setting  
0 - Direct Compensation  
\*RST:            1

**Example:**            See [SENSe<Ch>:]CORRection:COLLect:FIXTure[:  
ACQUIRE]

**Manual operation:** See "[Direct Compensation](#)" on page 503

---

**[SENSe:]CORRection:COLLect:FIXTure:LMPParameter:LOSS[:STATe]** <Boolean>

Selects an Auto Length or an Auto Length and Loss calculation.

**Parameters:**

<Boolean>            1 - Auto Length and Loss  
0 - Auto Length, no loss  
\*RST:            1

**Example:**            See [SENSe<Ch>:]CORRection:COLLect:FIXTure[:  
ACQUIRE]

**Manual operation:** See "[Auto Length / Auto Length and Loss](#)" on page 503

---

**[SENSe<Ch>:]CORRection[:STATe]** <Boolean>

Enables or disables the system error correction for channel <Ch>.

**Suffix:**

<Ch>                    Calibrated channel number

**Parameters:**

<Boolean>            Enables (ON) or disables (OFF) the correction.  
\*RST:            ON

**Example:** `*RST; :CORR?`  
Reset the instrument and query whether channel 1 is system error corrected. The response is 1.

**Manual operation:** See "[User Cal Active](#)" on page 480

---

**[SENSe<Ch>:]CORRection:COLLect[:ACQuire]:SELEcted <Type>, <TestPort>[, <SecondPortOrAdapter>[, <Dispersion>[, <DelayTimePhase>]]]**

Starts the acquisition of measurement data for the selected standard and port(s). The standards are reflection or transmission standards and can be connected to arbitrary analyzer ports.

**Note:**

- The calibration measurement has a variable timeout:  $Timeout = (Sweep\ time / Number\ of\ sweep\ points) * 3 + 0.1\ s$   
The timeout may be reached e.g. while the measurement waits for the specified trigger event. It is used for all standard measurements).
- For a sliding match, the R&S ZNL/ZNLE can acquire measurement data for up to 20 positions per port. Multiple calls of `[SENSe<Ch>:]CORRection:COLLect[:ACQuire]:SELEcted SLIDE, <TestPort>` for the same test port, implicitly increases the position until position 20 has been recorded. Subsequent calls will start over at position 1, overwriting the previously acquired data.

**Suffix:**

<Ch> Channel number of the calibrated channel

**Setting parameters:**

<Type> THROugh | OPEN | SHORt | OSHort | OSHort1 | OSHort2 | OSHort3 | MATCh | NET | ATT | REFL | SLIDe | ISOLation | UTHROugh

Standard types: Through, Open, Short, Match, Symmetric Network (NET), Attenuation (ATT), Reflect, Sliding Match (SLIDe), Offset Short 1 to 3 (OSHOort), Unknown Through.

**ISOLation** is not a physical standard: to measure the isolation (supported for transmission normalization and TOSM only!) it is recommended to suitably terminate the related test ports (e.g. with 50 Ω loads).

<TestPort> Test port number.

For a transmission standard or an adapter that is used as a "through", the input and output port numbers must be specified. For reflection standards, only one port number is required.

\*RST: n/a

<SecondPortOrAdapter> For a transmission standard or an adapter that is used as a "through", this parameter specifies the second test port. For reflection measurements with an adapter connected between port and standard, set it to ON. Otherwise set it to OFF or simply omit it.

|                               |                                                                                                                                                                                                                                                                                                                                                                                                                                                                                                                                                                                                                                                                                                                                                                                                                                                                                                                                                                                                                                                                                                                                                                                                                                                                                                                                                                                                                                                                                                                                                                                                      |
|-------------------------------|------------------------------------------------------------------------------------------------------------------------------------------------------------------------------------------------------------------------------------------------------------------------------------------------------------------------------------------------------------------------------------------------------------------------------------------------------------------------------------------------------------------------------------------------------------------------------------------------------------------------------------------------------------------------------------------------------------------------------------------------------------------------------------------------------------------------------------------------------------------------------------------------------------------------------------------------------------------------------------------------------------------------------------------------------------------------------------------------------------------------------------------------------------------------------------------------------------------------------------------------------------------------------------------------------------------------------------------------------------------------------------------------------------------------------------------------------------------------------------------------------------------------------------------------------------------------------------------------------|
| <b>&lt;Dispersion&gt;</b>     | Optional status parameter for UTHRough standard:<br>OFF - unknown through standard is non-dispersive.<br>ON - unknown through standard is dispersive.<br><br>*RST:       OFF                                                                                                                                                                                                                                                                                                                                                                                                                                                                                                                                                                                                                                                                                                                                                                                                                                                                                                                                                                                                                                                                                                                                                                                                                                                                                                                                                                                                                         |
| <b>&lt;DelayTimePhase&gt;</b> | Optional entry of delay time or phase for UTHRough standard:<br>AUTO - the analyzer determines the delay time or phase during the calibration sweep.<br><delay or phase> - entry of the delay time in ps (for non-dispersive standards) or of the phase at the start frequency of the sweep in deg (for dispersive standards). If an estimate of the start phase is entered, the analyzer uses the <b>calculated</b> value which is closest to the estimate.<br><b>Automatic determination of the phase</b><br>The UOSM algorithm provides the transmission factor of the unknown through standard up to an ambiguous sign. This yields the two alternative phase values displayed in the calibration wizard; see Unknown Through Standard.<br>In remote control, the analyzer performs a plausibility check in order to determine the correct phase. No manual selection is necessary. The check starts at the first sweep point, using the transmission factor with negative phase. The analyzer measures the phase at the subsequent sweep points, assuming that the phase difference between any two consecutive points is less than 90 deg. From these phase values, the analyzer calculates a linear extrapolation and derives an estimate for the DC phase limit. If this DC phase is in the vicinity of ... -180 deg, +180 deg, ... then the transmission factor with negative phase is adopted. If the DC phase is in the vicinity of ... 0 deg, +360 deg, ... then the transmission factor with inverted sign (corresponding to a 180 deg phase shift) is adopted.<br><br>*RST:       AUTO |
| <b>Example:</b>               | See [SENSe<Ch>:]CORRection:COLLect:SAVE:SELected[:DUMMy] or "Adapter Removal" on page 986                                                                                                                                                                                                                                                                                                                                                                                                                                                                                                                                                                                                                                                                                                                                                                                                                                                                                                                                                                                                                                                                                                                                                                                                                                                                                                                                                                                                                                                                                                            |
| <b>Usage:</b>                 | Setting only                                                                                                                                                                                                                                                                                                                                                                                                                                                                                                                                                                                                                                                                                                                                                                                                                                                                                                                                                                                                                                                                                                                                                                                                                                                                                                                                                                                                                                                                                                                                                                                         |
| <b>Manual operation:</b>      | See "Start Cal Sweep" on page 465                                                                                                                                                                                                                                                                                                                                                                                                                                                                                                                                                                                                                                                                                                                                                                                                                                                                                                                                                                                                                                                                                                                                                                                                                                                                                                                                                                                                                                                                                                                                                                    |

---

**[SENSe<Ch>:]CORRection:COLLect:AUTO** <Characterization>, <TestPort>[, <TestPort>]...

Selects and initiates an automatic calibration for the specified test ports using a single, auto-detected port assignment.

**Tip:**

- If the test setup contains a high attenuation, the analyzer may fail to detect the cal unit ports connected to each of its ports. In this case use the extended command [SENSe<Ch>:]CORRection:COLLect:AUTO:PORTs.

- Use `[SENSe<Ch>:]CORRection:COLLect:AUTO:TYPE` if you want to specify a particular calibration type for the automatic calibration.
- If several calibration units are connected, use `SYSTem:COMMunicate:RDEvice:AKAL:ADDResS` to select a unit for the calibration.

**Suffix:**

<Ch> Channel number of the calibrated channel

**Setting parameters:**

<Characterization> Location of the characterization (cal kit file) to be used for the automatic calibration (string parameter):

- If an empty string ( ' ' ) is specified, the factory cal kit file stored in the active calibration unit is used.
- A VNA cal kit file name `*.calkit` without path refers to a specific cal kit file stored in the internal memory of the active calibration unit.
- A VNA cal kit file name without path but prefixed with "SD:" refers to a specific cal kit file stored on the SD card inserted at the active calibration unit.
- A VNA cal kit file name `*.calkit` with path refers to a specific cal kit file stored in an arbitrary directory on the analyzer.

<TestPort>

<TestPort> Test port numbers. For an n-port automatic calibration, n arbitrary (not necessarily consecutive) port numbers must be specified. The analyzer automatically detects the calibration unit ports connected to each analyzer port.

**Example:**

```
CORR:COLL:AUTO '', 1, 2, 4
```

Perform an automatic 3-port calibration at test ports 1, 2, and 4 using the calibration unit's default calibration kit file and arbitrary test ports of the cal unit.

**Usage:**

Setting only

**Manual operation:** See "[Apply/Cancel](#)" on page 460

**[SENSe<Ch>:]CORRection:COLLect:AUTO:CONFIgure <CalType>, <Characterization>[, <CalName>]**

Selects a calibration type and a cal unit characterization (cal kit file) for an automatic calibration.

**Suffix:**

<Ch> Channel number of the calibrated channel

**Parameters:**

<CalType> FNPort | TOSM | FOPort | OPTPort | FRTRans | FTRans | RTRans | REFL | RSHort

Calibration Type

**FNPort**

Full n-port (UOSM) calibration

**TOSM**

Full n-port calibration with characterized Through.

If the selected cal unit characterization does not contain a Through characterization, the command silently falls back to a FNPort (UOSM) calibration.

**FOPort**

Full one-port ("Refl OSM") calibration

**OPTPort**

"One Path Two Ports" calibration

If the selected cal unit characterization does not contain a Through characterization, the command will fail.

**FRTRans**

Transmission normalization, bidirectional

If the selected cal unit characterization does not contain a Through characterization, the command will fail.

**FTRans | RTRans**

Transmission normalization, forward | reverse

If the selected cal unit characterization does not contain a Through characterization, the command will fail.

**REFL**

Reflection normalization, Open

**RShort**

Reflection normalization, Short

<Characterization>

Location of the characterization (cal kit file) to be used for the automatic calibration (string parameter):

- The empty string ( ' ') refers to the factory calibration of (and stored on) the active calibration unit.
- A VNA cal kit file name \*.calkit without path refers to a specific cal kit file stored in the internal memory of the active calibration unit.
- A VNA cal kit file name without path but prefixed with "SD:" refers to a specific cal kit file stored on the SD card inserted at the active calibration unit.
- A VNA cal kit file name \*.calkit with path refers to a specific cal kit file stored in an arbitrary directory on the analyzer.

**Setting parameters:**

<CalName>

**Example:**

```
SENSE1:CORRection:COLLect:AUTO:CONFIgure
FNPort, ''
```

Sets the automatic calibration to "Full n-port" with factory characterization.

**[SENSe<Ch>:]CORRection:COLLect:AUTO:PORTs** <Characterization>, <TestPort1>, <CalUnitPort1>[, <TestPort2>]...

Selects and initiates an automatic calibration at arbitrary analyzer and calibration unit ports. A progress monitor for the calibration sweeps is displayed.

**Tip:**

- This command is necessary if the analyzer fails to detect the cal unit ports connected to each of its ports (e.g. because of a high attenuation in the test setup). If auto-detection works you can use the simpler command `[SENSe<Ch>:]CORRection:COLLect:AUTO`.
- If several calibration units are connected, use `SYSTEM:COMMunicate:RDEvice:AKAL:ADDRESS` to select a unit for the calibration.

**Suffix:**

<Ch> Channel number of the calibrated channel

**Setting parameters:**

<Characterization> Location of the characterization (cal kit file) to be used for the automatic calibration (string parameter):

- If an empty string ( ' ' ) is specified, the factory cal kit file stored in the active calibration unit is used.
- A VNA cal kit file name `*.calkit` without path refers to a specific cal kit file stored in the internal memory of the active calibration unit.
- A VNA cal kit file name without path but prefixed with "SD:" refers to a specific cal kit file stored on the SD card inserted at the active calibration unit.
- A VNA cal kit file name `*.calkit` with path refers to a specific cal kit file stored in an arbitrary directory on the analyzer.

<TestPort1> Test port numbers. For an n-port automatic calibration, n arbitrary (not necessarily consecutive) port numbers must be specified.

<CalUnitPort1> Port numbers of the cal unit. For an n-port automatic calibration, n arbitrary (not necessarily consecutive) port numbers must be specified. It is possible to combine arbitrary (not necessarily matching) pairs of analyzer and cal unit ports.

<TestPort2>

**Example:**

`CORR:COLL:AUTO:PORT ' ', 1, 2`

Perform an automatic 1-port calibration at analyzer port 1, using the calibration unit's default calibration kit file and port 2 of the cal unit.

**Usage:**

Setting only

**Manual operation:**

See "[Apply/Cancel](#)" on page 460



```
[SENSe<Ch>:]CORRection:COLLect:AUTO:PORTs:TYPE <CalType>[,
 <Characterization>[, <TestPort1>[, <CalUnitPort1>[, <TestPort2>]...]]]
```

Selects and initiates an automatic calibration at arbitrary test and calibration unit ports. A progress monitor for the calibration sweeps is displayed.

**Tip:** This command is necessary if the analyzer fails to detect the cal unit ports connected to each of its ports (e.g. because of a high attenuation in the test setup). If auto-detection works you can use the simpler command `[SENSe<Ch>:]CORRection:COLLect:AUTO:TYPE`.

**Suffix:**

<Ch> Channel number of the calibrated channel

**Setting parameters:**

<CalType> FNPort | TOSM | FOPort | OPTPort | FRTRans | FTRans |  
RTRans | REFL | RSHort

Calibration Type

**FNPort**

Full n-port (UOSM) calibration

**TOSM**

Full n-port calibration with characterized Through.

If the selected cal unit characterization does not contain a Through characterization, the command silently falls back to a FNPort (UOSM) calibration.

**FOPort**

Full one-port ("Refl OSM") calibration

**OPTPort**

"One Path Two Ports" calibration

If the selected cal unit characterization does not contain a Through characterization, the command will fail.

**FRTRans**

Transmission normalization, bidirectional

If the selected cal unit characterization does not contain a Through characterization, the command will fail.

**FTRans | RTRans**

Transmission normalization, forward | reverse

If the selected cal unit characterization does not contain a Through characterization, the command will fail.

**REFL**

Reflection normalization, Open

**RSHort**

Reflection normalization, Short

<Characterization> Location of the characterization (cal kit file) to be used for the automatic calibration (string parameter):  
– If an empty string ( ' ' ) is specified, the factory cal kit file stored in the active calibration unit is used.

|                          |                                                                                                                                                                                                                                                                                                                                                                                                                                                                                                                      |
|--------------------------|----------------------------------------------------------------------------------------------------------------------------------------------------------------------------------------------------------------------------------------------------------------------------------------------------------------------------------------------------------------------------------------------------------------------------------------------------------------------------------------------------------------------|
|                          | <ul style="list-style-type: none"> <li>– A VNA cal kit file name *.calkit without path refers to a specific cal kit file stored in the internal memory of the active calibration unit.</li> <li>– A VNA cal kit file name without path but prefixed with "SD:" refers to a specific cal kit file stored on the SD card inserted at the active calibration unit.</li> <li>– A VNA cal kit file name *.calkit with path refers to a specific cal kit file stored in an arbitrary directory on the analyzer.</li> </ul> |
| <TestPort1>              | Test port number. For an n-port automatic calibration, n arbitrary (not necessarily consecutive) port numbers must be specified. For a one path two port calibration (OPTPort), the first port no. denotes the source port (fully calibrated port).                                                                                                                                                                                                                                                                  |
| <CalUnitPort1>           | Port numbers of the cal unit. For an n-port automatic calibration, n arbitrary (not necessarily consecutive) port numbers must be specified. It is possible to combine arbitrary (not necessarily matching) pairs of analyzer and cal unit ports.                                                                                                                                                                                                                                                                    |
| <TestPort2>              | Second test port number<br>*RST: n/a                                                                                                                                                                                                                                                                                                                                                                                                                                                                                 |
| <b>Example:</b>          | <pre>CORR:COLL:AUTO:PORT FNPort, ', 1, 2, 2, 4, 4, 1</pre> <p>Perform an automatic full 3-port calibration at test ports 1, 2, and 4 using the calibration unit's default calibration kit file and ports 2, 4, and 1 of the cal unit.</p>                                                                                                                                                                                                                                                                            |
| <b>Usage:</b>            | Setting only                                                                                                                                                                                                                                                                                                                                                                                                                                                                                                         |
| <b>Manual operation:</b> | See " <a href="#">Calibration Type / Source</a> " on page 456                                                                                                                                                                                                                                                                                                                                                                                                                                                        |

---

```
[SENSe<Ch>:]CORRection:COLLect:AUTO:TYPE <CalType>[, <Characterization>[, <TestPort1>[, <TestPort2>]...]]
```

Selects and initiates an automatic calibration at arbitrary analyzer and cal unit ports. This command also selects the calibration type. A progress monitor for the calibration sweeps is displayed.

**Tip:** If the test setup contains a high attenuation the analyzer may fail to detect the cal unit ports connected to each of its ports. In this case use the extended command `[SENSe<Ch>:]CORRection:COLLect:AUTO:PORTs:TYPE`.

If several calibration units are connected, use `SYSTem:COMMunicate:RDEvice:AKAL:ADDRes` to select a unit for the calibration.

**Suffix:**

<Ch> Channel number of the calibrated channel

**Setting parameters:**

<CalType> FNPort | TOSM | FOPort | OPTPort | FRTRans | FTRans | RTRans | REFL | RSHort  
Calibration Type

**FNPort**

Full n-port (UOSM) calibration

**TOSM**

Full n-port calibration with characterized Through.

If the selected cal unit characterization does not contain a Through characterization, the command silently falls back to a FNPort (UOSM) calibration.

**FOPort**

Full one-port ("Refl OSM") calibration

**OPTPort**

"One Path Two Ports" calibration

If the selected cal unit characterization does not contain a Through characterization, the command will fail.

**FRTRans**

Transmission normalization, bidirectional

If the selected cal unit characterization does not contain a Through characterization, the command will fail.

**FTRans | RTRans**

Transmission normalization, forward | reverse

If the selected cal unit characterization does not contain a Through characterization, the command will fail.

**REFL**

Reflection normalization, Open

**RShort**

Reflection normalization, Short

|                                 |                                                                                                                                                                                                                                                                                                                                                                                                                                                                                                                                                                                                                                                                                                                                                                                          |
|---------------------------------|------------------------------------------------------------------------------------------------------------------------------------------------------------------------------------------------------------------------------------------------------------------------------------------------------------------------------------------------------------------------------------------------------------------------------------------------------------------------------------------------------------------------------------------------------------------------------------------------------------------------------------------------------------------------------------------------------------------------------------------------------------------------------------------|
| <b>&lt;Characterization&gt;</b> | <p>Location of the characterization (cal kit file) to be used for the automatic calibration (string parameter):</p> <ul style="list-style-type: none"> <li>– The empty string ( ' ' ) refers to the factory calibration of (and stored on) the active calibration unit.</li> <li>– A VNA cal kit file name <code>*.calkit</code> without path refers to a specific cal kit file stored in the internal memory of the active calibration unit.</li> <li>– A VNA cal kit file name without path but prefixed with "SD:" refers to a specific cal kit file stored on the SD card inserted at the active calibration unit.</li> <li>– A VNA cal kit file name <code>*.calkit</code> with path refers to a specific cal kit file stored in an arbitrary directory on the analyzer.</li> </ul> |
| <b>&lt;TestPort1&gt;</b>        | <p>Test port numbers. For an n-port automatic calibration, n arbitrary (not necessarily consecutive) port numbers must be specified.</p>                                                                                                                                                                                                                                                                                                                                                                                                                                                                                                                                                                                                                                                 |
| <b>&lt;TestPort2&gt;</b>        | <p>Second test port number of the analyzer</p>                                                                                                                                                                                                                                                                                                                                                                                                                                                                                                                                                                                                                                                                                                                                           |
| <b>Example:</b>                 | <pre>CORR:COLL:AUTO:TYPE FNPort, '', 1, 2, 4</pre> <p>Perform an automatic full 3-port calibration at test ports 1, 2, and 4 using the calibration unit's default calibration kit file and arbitrary test ports of the cal unit.</p>                                                                                                                                                                                                                                                                                                                                                                                                                                                                                                                                                     |

**Usage:** Setting only

**Manual operation:** See "[Calibration Type / Source](#)" on page 456

**[SENSe<Ch>:]CORRection:COLLect:CKIT:INSTall** <CalKitFile>, <Gender>[, <Ports>]

Allows you to load cal kit data by gender:

- From the given file
- To the given ports or all ports

Use [MMEMory:CKIT:INFO?](#) on page 785 to get information about cal kit files.

**Suffix:**

<Ch> Channel number

**Setting parameters:**

<CalKitFile> Path to the cal kit file, either absolute or relative to the current directory (see [MMEMory:CDIRectory](#))

<Gender> MALE | FEMale | NGENder

<Ports> Either a comma-separated list of port numbers or ALL (optional)

**Usage:** Setting only

**[SENSe<Ch>:]CORRection:COLLect:CKIT:LOAD** <CalKitName>, <KitLabel>, <Gender>[, <Ports>]

Allows you to load cal kit data by name, label and gender:

- From the pool
- To the given ports or all ports

**Suffix:**

<Ch> Channel number

**Setting parameters:**

<CalKitName> The name of the cal kit to be loaded

<KitLabel> The label of the cal kit to be loaded

<Gender> MALE | FEMale | NGENder

The gender of the cal kit to be loaded

<Port> Either a comma-separated list of port numbers or ALL (optional)

**Usage:** Setting only

**[SENSe<Ch>:]CORRection:COLLect:CKIT:PORT<PhyPt>?** [<Detail>]

Queries the cal kit data assigned to the given port via

- [\[SENSe<Ch>:\]CORRection:COLLect:CKIT:LOAD](#)  
or [\[SENSe<Ch>:\]CORRection:COLLect:CKIT:INSTall](#)

**Suffix:**

<Ch> Channel number

<PhyPt> Port number

**Query parameters:**

<Detail> CONNector | LABEL | NAME | GENDER  
Queried property

**Return values:**

<Result>

**Usage:** Query only

---

**[SENSe<Ch>:]CORRection:COLLect:CONNection<PhyPt>** <ConnectorType>

Selects a connector type at a specified port <PhyPt> and its gender.

**Tip:** Use `[SENSe<Ch>:]CORRection:COLLect:SCONNection<PhyPt>` to select an arbitrary connector type using a string variable.

**Suffix:**

<Ch> Channel number of the calibrated channel

<PhyPt> Port numbers of the analyzer

**Note:** If the analyzer is set to use the same connectors at all ports (`[SENSe<Ch>:]CORRection:COLLect:CONNection:PORTs ALL`), then a change of a connector type is valid for all ports. The gender of the connectors can still be different.

**Parameters:**

<ConnectorType> N50Female | N50Male | N75Female | N75Male | PC7 | SMAFemale | SMAMale | PC35female | PC35male | PC292female | PC292male | PC24female | PC24male | PC185female | PC185male | S7\_16female | S7\_16male | BNC50male | BNC50female | BNC75male | BNC75female | UFEMale1 | UMALe1 | UFEMale2 | UMALe2  
Connector type and gender of the connectors (omitted for query). The R&S ZVR-compatible parameters UFEMALE1 and UMALE1 denote the user-defined connector type "UserConn1", UFEMALE2 and UMALE2 denote the user-defined connector type "UserConn2". The user-defined connector types must be defined before being addressed by  
`[SENSe<Ch>:]CORRection:COLLect:CONNection<PhyPt>`.

\*RST: N50FEMALE for all ports.

**Example:**

\*RST; :CORR:COLL:CONN1 N75MALE; CONN4?  
Change the connector type at port 1 from N50FEMALE to N75MALE. The connector type at the other ports is also changed to N75, however, the gender (female) is maintained.  
CORR:COLL:CONN4? returns N75FEMALE.

**Manual operation:** See ["Connector"](#) on page 383

---

**[SENSe<Ch>:]CORRection:COLLect:CONNection:GENDeRs <Gender>**

Qualifies whether the genders at the test ports (but not their connector types) are equal or independent.

**Suffix:**

<Ch> Channel number of the calibrated channel

**Parameters:**

<Gender> ALL | SINGle  
 ALL – equal (uniform) genders. If the gender at one port is changed, the connector type at all other ports is changed accordingly.  
 SINGle – independent (possibly non-uniform) genders at the ports.  
 \*RST: SINGle

**Example:** See [\[SENSe<Ch>:\]CORRection:COLLect:CONNection:PORTs](#)

**Manual operation:** See ["Same Connector All Ports / Same Gender All Ports"](#) on page 464

---

**[SENSe<Ch>:]CORRection:COLLect:CONNection:PORTs <ConnectorType>**

Qualifies whether the connector types at the test ports (but not their gender) are equal or independent. Some calibration types require uniform port connector types.

**Suffix:**

<Ch> Channel number of the calibrated channel

**Parameters:**

<ConnectorType> ALL | SINGle  
 ALL – equal (uniform) connector types. If the connector type at one port is changed, the connector type at all other ports is changed accordingly.  
 SINGle – independent (possibly non-uniform) connector types at the ports.  
 \*RST: ALL

**Example:** CORR:COLL:CONN:PORTS SING  
 Select independent connector types at the ports.  
 CORR:COLL:CONN1 N50MALE; CONN4 N75FEMALE;  
 CONN2?  
 Select independent connector types at ports 1 and 4. The connector type at port 2 is not changed; the query returns N50FEMALE.

**Manual operation:** See ["Same Connector All Ports / Same Gender All Ports"](#) on page 464

**[SENSe<Ch>:]CORRection:COLLect:DELeTe [<CalName>]**

Deletes system error correction data generated and stored previously.

**Suffix:**

<Ch> Channel number of the calibrated channel

**Setting parameters:**

<CalName> Name of the calibration (string parameter) defined together with the calibration type (`[SENSe<Ch>:]CORRection:COLLect:METhod:DEFine`).

ALL - the analyzer deletes all calibrations.

If nothing is specified the analyzer deletes the last system error correction stored by means of `[SENSe<Ch>:]CORRection:COLLect:SAVE:SELeCted[:DUMMy]`.

\*RST: -

**Example:**

```
CORR:COLL:METh:DEF 'Test',RShort,1
```

Select a one-port normalization at port 1 with a short standard as calibration type.

```
CORR:COLL:SEL SHOR,1
```

Measure a short standard connected to port 1 and store the measurement results of this standard.

```
CORR:COLL:SAVE:SEL
```

```
CORR:COLL:DEL ALL
```

Calculate the system error correction data and apply it to the active channel, then delete the data.

**Usage:** Setting only

**Manual operation:** See ["Apply"](#) on page 466

**[SENSe<Ch>:]CORRection:COLLect:DISCard**

Terminates a system error correction, discarding the acquired data.

**Suffix:**

<Ch> Channel number of the calibrated channel

**Example:**

```
:SENSe1:CORRection:COLLect:METhod:DEFine 'Test', TOSM, 1, 2
```

```
:SENSe1:CORRection:COLLect:ACQuire:SELeCted THROugh, 1, 2
```

```
:SENSe1:CORRection:COLLect:ACQuire:SELeCted OPEN, 1
```

```
:SENSe1:CORRection:COLLect:ACQuire:SELeCted SHORt, 1
```

```
:SENSe1:CORRection:COLLect:ACQuire:SELeCted MATCh, 1
```

```
:SENSe1:CORRection:COLLect:ACQuire:SELeCted OPEN, 2
```

```
:SENSe1:CORRection:COLLect:ACQuire:SELeCted MATCh, 2
```

```
:SENSe1:CORRection:COLLect:DISCard
```

**Usage:** Event

**[SENSe<Ch>:]CORRection:COLLect:FIXTure[:ACQuire] <StandardType>, <TestPort1>[, <TestPort2>]...**

Starts a fixture compensation sweep in order to acquire measurement data for a test fixture that has its inner conductor terminated with the selected standards.

**Suffix:**

<Ch> Channel number of the corrected channel

**Setting parameters:**

<StandardType> OPEN | SHORt  
Terminating standard type: open or short.

<TestPort1>

<TestPort2> Test port numbers. For a fixture compensation, n arbitrary (not necessarily consecutive) port numbers must be specified.

\*RST: -

**Example:**

\*RST; CORR:COLL:FIXT:LMP:LOSS OFF

Configure a fixture compensation measurement (for all channels): The analyzer performs an Auto Length (no loss) calculation.

CORR:COLL:FIXT:ACQ OPEN, 2; :CORR:COLL:FIXT:ACQ SHOR, 4

Perform a fixture compensation sweep at port 2, terminated with an open standard, and at port 4, terminated with a short.

CORR:COLL:FIXT:SAVE

Save and apply the compensation data.

CORR:COLL:FIXT:STAR

Prepare a new fixture compensation measurement, deleting the previous data for channel 1.

CORR:COLL:FIXT:LMP OFF

Select a Direct Compensation measurement (for all channels and traces).

CORR:COLL:FIXT:ACQ SHOR, 1, 3

Perform a fixture compensation sweep at ports 1 and 3, terminated with a short standard.

CALC2:PAR:SDEF 'Trc2', 'S22'

Create channel no. 2 with a trace named Trc2.

SENS2:CORR:COLL:FIXT:STAR

Prepare a fixture compensation measurement for channel 2. The channel 1 data is not affected.

SENS2:CORR:COLL:FIXT:ACQ SHOR, 1, 3

Repeat the previous fixture compensation sweep for channel 2.

SENS1:CORR:COLL:FIXT:SAVE; :SENS2:CORR:COLL:FIXT:SAVE

Save and apply the compensation data for both channels.

SENS1:CORR:OFFS3:DFC?; :SENS2:CORR:OFFS3:DFC?

Query whether the analyzer uses Direct Compensation results at port 3. The response is 1;1 (true for both channels).



**Usage:** Setting only

**Manual operation:** See "[Measure Fixture wizard](#)" on page 504

---

**[SENSe<Ch>:]CORRection:COLLect:FIXTure:EXPort** <FixtureFile>, <StandardType>, <TestPort1>[, <TestPort2>]...

**[SENSe<Ch>:]CORRection:COLLect:FIXTure:IMPort** <FixtureFile>, <StandardType>, <TestPort1>[, <TestPort2>]...

Loads/saves "Direct Compensation" data from/to the specified file.

The EXPort command first acquires the required data, just as a [\[SENSe<Ch>:\]CORRection:COLLect:FIXTure\[:ACQuire\]](#) would do.

"Direct Compensation" data files are standard [Trace Files](#), containing reflection parameter traces for the related port(s) and standard.

*Table 11-17: Direct Compensation data*

| #TestPorts | File Type |
|------------|-----------|
| 1          | s1p       |
| >=1        | csv       |

For 1-port Touchstone files (\*.s1p) only a single test port can be specified - otherwise an error is raised.

**Suffix:**

<Ch> Channel number

**Parameters:**

<FixtureFile> Path to the "Direct Compensation" data file, either absolute or relative to the current directory (set/queried using [MMEMoRY:CDIRectory](#))

**Setting parameters:**

<StandardType> OPEN | SHORt  
Terminating standard type

<TestPort1>[, <TestPort2>, ...] Test port numbers. For a fixture compensation, n different (but not necessarily consecutive) port numbers must be specified.

**Example:**

```
*RST; SENSE1:CORR:COLL:FIXT:LMP OFF
```

Activate "Direct Compensation".

```
SENSE1:CORR:COLL:FIXT:EXP 'Traces\pl2_short.csv', SHOR, 1, 2
```

Acquire "Direct Compensation" data for ports 1 and 2 (whose inner connectors have to be terminated with a Short) and save the acquired data to file.

In a subsequent measurement session you can load and apply these data as follows:

```
*RST;
```

```
:SENSE1:CORR:COLL:FIXT:LMP OFF
```

```
:SENSE1:CORR:COLL:FIXT:IMP 'Traces\pl2short.csv', SHOR, 1, 2
```

```
:SENSE1:CORR:COLL:FIXT:SAVE
```

**Usage:** Setting only

**Manual operation:** See ["Measure Fixture wizard"](#) on page 504

**[SENSE<Ch>:]CORRection:COLLect:FIXTure:SAVE**

Completes a fixture compensation, storing and applying the acquired data.

**Suffix:**

<Ch> Channel number of the corrected channel

**Example:**

See [\[SENSE<Ch>:\]CORRection:COLLect:FIXTure\[:ACQuire\]](#)

**Usage:**

Event

**Manual operation:** See ["Measure Fixture wizard"](#) on page 504

**[SENSE<Ch>:]CORRection:COLLect:FIXTure:START**

Prepares the analyzer for fixture compensation comprising a single or a series of fixture compensation sweeps

([\[SENSE<Ch>:\]CORRection:COLLect:FIXTure\[:ACQuire\]](#)). Previous compensation data is deleted.

**Suffix:**

<Ch> Channel number of the corrected channel

**Example:**

See [\[SENSE<Ch>:\]CORRection:COLLect:FIXTure\[:ACQuire\]](#)

**Usage:**

Event

**Manual operation:** See ["Measure Fixture wizard"](#) on page 504

**[SENSe<Ch>:]CORRection:COLLect:LOAD:SELected** <CalGroupFile>,  
<Standard>, <TestPort1>[, <SecondPortOrAdapter>]

Reloads a set of previously acquired calibration data for a particular standard from a file in the cal pool. The loaded data may be combined with new calibration measurement data ([\[SENSe<Ch>:\]CORRection:COLLect\[:ACQuire\]:SELected](#)) in order to simplify and speed up the new calibration procedure. The channel settings for loaded and new calibrations (e.g. the number of sweep points) must be identical.

**Note:**

- The analyzer performs a consistency check for the loaded data. If the loaded file is incompatible with the channel settings of channel <Ch>, or if it does not contain data for the specified standard and port(s), a command error message (-100, "Command error;...") is generated.
- For a sliding match, the R&S ZNL/ZNLE can acquire and load measurement data for up to 20 positions per port. Multiple calls of [\[SENSe<Ch>:\]CORRection:COLLect:LOAD:SELected](#) <CalGroupFile>, SLIDe, <TestPort> for the same cal group file and test port, implicitly increases the position until position 20 has been recorded. Subsequent calls will start over at position 1, overwriting the previously loaded data.

**Suffix:**

<Ch> Channel number of the calibrated channel

**Parameters:**

<CalGroupFile> String parameter to specify the name of the loaded cal group file.

<Standard> THROugh | OPEN | SHORt | OSHorT | OSHorT1 | OSHorT2 | OSHorT3 | MATCh | NET | ATT | REFL | SLIDe | ISOLation | UTHROugh

See [\[SENSe<Ch>:\]CORRection:COLLect\[:ACQuire\]:SELected](#) on page 844.

<TestPort1> Test port number. For a transmission standard (through, line, attenuation, symmetric network) or an adapter used as a "through" the input and output port numbers must be specified. For reflection standards, only one port number is required.

**Setting parameters:**

<SecondPortOrAdapter> For a transmission standard or an adapter used as a "through" this parameter specifies the second test port. For reflection measurements with an adapter connected between port and standard, set it to ON. Otherwise set it to OFF or simply omit it.

**Example:** Suppose that the cal pool contains a file 'Calgroup3.cal' with a valid through calibration for the active channel no. 1, which you want to include in a new TOSM calibration for ports 1 and 2.

```
MMEM:CDIR DEF; CDIR 'Calibration\Data'
```

Go to the cal group directory.

```
:SENSe1:CORRection:COLLect:METhod:DEFine 'New Cal', TOSM, 1, 2
```

Define a new TOSM calibration.

```
SENSe1:CORRection:COLLect:LOAD:SELEcted 'Cal Group 3.cal', THROUGH, 1, 2
```

Load the through data from the cal pool file into the new calibration.

```
SENSe1:CORRection:COLLect:ACQuire:SELEcted OPEN, 1
```

Proceed with the new calibration measurements.

**Manual operation:** See ["Start Cal Sweep"](#) on page 465

---

**[SENSe<Ch>:]CORRection:COLLect:METhod:DEFine** <CalName>, <CalType>, <TestPort1>[, <TestPort2>[, <TestPort3orAdapterCalKit>[, <TestPorts>]...]]

Defines the calibration to be performed for channel <Ch>.

If multiple channels shall be calibrated in parallel, use

- [SENSe:]CORRection:COLLect:CHANnels:ALL ON or
- [SENSe:]CORRection:COLLect:CHANnels:MCTypes ON

before executing this command. For background information see [Chapter 9.5.6, "Parallel Calibration of Multiple Channels"](#), on page 265.

Calibration data is acquired using [SENSe<Ch>:]CORRection:COLLect[:ACQuire]:SELEcted.

**Suffix:**

<Ch> Channel number

**Parameters:**

<CalName> Name of the calibration (string parameter). The name serves as a reference to delete a particular set of system correction data ([SENSe<Ch>:]CORRection:COLLect:DELEte).

<CalType> REFL | RSHort | FOPort | FTRans | RTRans | FRTRans | OPTPort | TOSM

Calibration types; see list below.

<TestPort1> First calibrated test port number. For an n-port calibration type, n port numbers must be specified. If more than n numbers are defined, the spare numbers (the last ones in the list) are ignored. Entering less than n numbers causes an error message. For a one path two port calibration (OPTPort), the first port no. denotes the node port (fully calibrated port).

<TestPort2> Second calibrated port number.

<TestPort3 or AdapterCalKit> Either the third calibrated port number, or - for Adapter Removal calibrations only - the file path (relative to the current directory) where the analyzer shall store the adapter characterization obtained during the calibration. The latter is optional. If a file path is provided the characterization file (in Touchstone s2p format) is generated when the correction terms are finally calculated (`[SENSe<Ch>:]CORRection:COLLect:SAVE:SElected[:DUMMy]`).

<TestPorts> More ports to be calibrated.

**Example:** `CORRection:COLLect:MEthod:DEFine 'Test',RSHort,1`  
 Select a one-port normalization at port 1 with a short standard as calibration type.

**Manual operation:** See "[Type/Source](#)" on page 462

The supported calibration types are listed below.

| Parameter                 | Type ("Calibration Presetting" dialog)                                                                                                                                   |
|---------------------------|--------------------------------------------------------------------------------------------------------------------------------------------------------------------------|
| REFL   RSHort             | Refl Norm Open   Refl Norm Short                                                                                                                                         |
| FOPort                    | Full One Port ("Refl OSM")                                                                                                                                               |
| FTRans   RTRans   FRTRans | Trans Norm - Forward   Trans Norm - Reverse   Trans Norm Both<br>"Forward" ("Reverse") means that the port with the smaller (larger) port number serves as a drive port. |
| OPTPort                   | One Path Two Ports                                                                                                                                                       |
| TOSM                      | TOSM                                                                                                                                                                     |

---

### `[SENSe<Ch>:]CORRection:DELeTe`

Cleans the channel's existing calibration data and also removes links to the calibration pool.

**Suffix:**

<Ch> Channel number

**Usage:** Event

---

### `[SENSe<Ch>:]CORRection:COLLect:SAVE:SElected:DEFault`

Generates a set of default system error correction data for the selected ports and calibration type. The default data set corresponds to a test setup which does not introduce any systematic errors; none of the measurement results acquired previously (`[SENSe<Ch>:]CORRection:COLLect[:ACQuire]:SElected`) is taken into account.

**Tip:** The main purpose of the default correction data set is to provide a dummy system error correction which you can replace with your own, external correction data. You may have acquired the external data in a previous session or even on an other instrument. If you want to use the external correction data on the analyzer, simply generate the default data set corresponding to your port configuration and calibration type and overwrite the default data. For details refer to the program example below.

**Suffix:**

<Ch> Channel number of the calibrated channel.

**Example:**

```
CORR:COLL:METH:DEF 'Test',RShort,1
```

Select a one-port normalization at port 1 with a short standard as calibration type.

```
CORR:COLL:SAVE:SEL:DEF
```

Calculate a dummy system error correction for the normalization at port 1. The dummy system error correction provides the reflection tracking error term 'REFLTRACK'.

```
CORR:CDAT? 'REFLTRACK',1,0
```

Query the dummy system error correction term. The response is a 1 (written as 1,0 for the real and imaginary part) for each sweep point (no attenuation and no phase shift between the analyzer and the calibration plane).

```
INIT:CONT OFF; :INIT; *WAI
```

Stop the sweep to ensure correct transfer of calibration data.

```
CORR:CDAT 'REFLTRACK',1,0,<ASCII_data>
```

Replace the dummy system error correction term with your own correction data, transferred in ASCII format.

```
INIT:CONT ON
```

Restart the sweep in continuous mode.

**Usage:** Event

**Manual operation:** See "Apply" on page 466

---

**[SENSe<Ch>:]CORRection:COLLect:SAVE:SELected[:DUMMy]**

Calculates the system error correction data from the acquired measurement results ([SENSe<Ch>:]CORRection:COLLect[:ACQuire]:SELected), stores it and applies it to the calibrated channel(s). To avoid incompatibilities, older system error correction data is deleted unless it has been transferred into a cal pool (MMEMory:STORe:CORRection <Ch>, '<file\_name>').

**Suffix:**

<Ch> One of the calibrated channels

If [SENSe:]CORRection:COLLect:CHANnels:ALL is ON this suffix can be omitted

|                          |                                                                                                                                                                                                                                                                                                                                                                                                                                                                                                                                |
|--------------------------|--------------------------------------------------------------------------------------------------------------------------------------------------------------------------------------------------------------------------------------------------------------------------------------------------------------------------------------------------------------------------------------------------------------------------------------------------------------------------------------------------------------------------------|
| <b>Example:</b>          | <pre>CORRection:COLLect:MEthod:DEFine 'Test',RShort, 1 Select a one-port normalization at port 1 with a short standard as calibration type. CORRection:COLLect:CHANnels:ALL ON Enable calibration in all channels of the active channel setup. CORRection:COLLect:SELEcted SHOR,1 Measure a short standard connected to port 1 and store the measurement results of this standard. CORRection:COLLect:SAVE:SELEcted Calculate the system error correction data and apply it to all channels of the active channel setup.</pre> |
| <b>Usage:</b>            | Event                                                                                                                                                                                                                                                                                                                                                                                                                                                                                                                          |
| <b>Manual operation:</b> | See <a href="#">"Apply"</a> on page 466                                                                                                                                                                                                                                                                                                                                                                                                                                                                                        |

---

### [SENSe<Ch>:]CORRection:COLLect:SCONnection<PhyPt> <Type>[, <Gender>]

Selects a connector type at a specified port <PhyPt> and its gender. In contrast to [\[SENSe<Ch>:\]CORRection:COLLect:CONNECTION<PhyPt>](#), this command uses a string variable to identify the connector type.

**Suffix:**

|         |                                                                                                                                                                                                                                                                                            |
|---------|--------------------------------------------------------------------------------------------------------------------------------------------------------------------------------------------------------------------------------------------------------------------------------------------|
| <Ch>    | Channel number of the calibrated channel                                                                                                                                                                                                                                                   |
| <PhyPt> | Port numbers of the analyzer. If the analyzer is set to use the same connectors at all ports ( <a href="#">[SENSe&lt;Ch&gt;:]CORRection:COLLect:CONNECTION:PORTs ALL</a> ), then a change of a connector type is valid for all ports. The gender of the connectors can still be different. |

**Parameters:**

|          |                                                                                                                                                                                                          |
|----------|----------------------------------------------------------------------------------------------------------------------------------------------------------------------------------------------------------|
| <Type>   | Connector type (string parameter) of the connectors. See "Cal kit naming conventions" under <a href="#">[SENSe:]CORRection:CKIT:&lt;ConnType&gt;:SELEct</a> .<br><br>*RST: 'N 50 Ohm',FEM for all ports. |
| <Gender> | MALE   FEMale<br><br>Gender of the connectors. The gender designation is not necessary (and ignored) for sexless connector types.                                                                        |

|                 |                                                                                                                                                                                                                                                                                                     |
|-----------------|-----------------------------------------------------------------------------------------------------------------------------------------------------------------------------------------------------------------------------------------------------------------------------------------------------|
| <b>Example:</b> | <pre>*RST; :CORR:COLL:SCON1 'N 75 Ohm', MALE; SCON4? Change the connector type at port 1 from 'N 50 Ohm', FEM to 'N 75 Ohm', MALE. The connector type at the other ports is also changed to N 75 Ohm, however, the gender (female) is main- tained. CORR:COLL:SCON4? returns 'N 75 Ohm', FEM.</pre> |
|-----------------|-----------------------------------------------------------------------------------------------------------------------------------------------------------------------------------------------------------------------------------------------------------------------------------------------------|

|                          |                                                      |
|--------------------------|------------------------------------------------------|
| <b>Manual operation:</b> | See <a href="#">"Connector / Gender"</a> on page 463 |
|--------------------------|------------------------------------------------------|

---

**[SENSe<Ch>:]CORRection:CONNection <ConnectorName>[, <Mode>[, <Gender>[, <RelPermittivity>[, <Reflmpedance>]]]]**

Configures the user-defined connector types.

**Suffix:**

<Ch> Channel number

**Parameters:**

<ConnectorName> Name of the user-defined connectors, string parameter.

<Mode> TEM | WGUide  
Transverse electric or waveguide type propagation mode.

<Gender> GENDER | NGENER  
GENDER – polar connector type (m/f)  
NGENDER – sexless connector type

<RelPermittivity> Relative permittivity  
Range: 0.0000000001 to 1000.

<Reflmpedance> For TEM type connectors: reference impedance in  $\Omega$  (without unit), For waveguide (WGUide) type connectors: cutoff frequency in Hz (without unit).

Range: Ref. impedance:  $1\mu\Omega$  to 1000 M $\Omega$ . Cutoff frequency: 0 Hz to 1000 GHz.

\*RST: -

**Example:**

CORR:CONN 'USERCON', TEM, GEND, 1.00000, 50

Define a TEM type connector type named USERCON.

CORR:CONN? 'USERCON'

Query the properties of the configured connector type.

CORR:CONN:DEL 'USERCON'

Delete the configured connector type.

**Manual operation:** See "[Connector / Gender](#)" on page 463

---

**[SENSe<Ch>:]CORRection:CONNection:CATalog?**

Returns a list of the connector types of all calibration kits in use.

**Suffix:**

<Ch> Channel number. This suffix is ignored because connector types are channel-independent.



- Example:** CORRection:CONNection:CATalog?  
 Query connector types. Possible response: 'N 50 Ohm,N 75 Ohm,7 mm,3.5 mm,2.92 mm,2.4 mm,1.85 mm,7-16,Type F (75),BNC 50 Ohm,BNC 75 Ohm,SMA,4.3-10,User Conn 1'  
 CORRection:CKIT:CATalog? 'N 50 Ohm'  
 Query cal kits for N (50 Ω) connector types. Possible response: 'N 50 Ohm Ideal Kit,3653,85054D,ZV-Z121,ZCAN 50 Ohm,ZV-Z21 typical,85032B/E,85032F,85054B,New Kit 1'. We assume that a cal kit New Kit 1 with label 2012-05-25 was created before.  
 CORRection:CKIT:LCATalog? 'N 50 Ohm'  
 Query cal kits for N (50 Ω) connector types with their labels. Possible response: 'N 50 Ohm Ideal Kit,,3653,,85054D,,ZV-Z121,,ZCAN 50 Ohm,,ZV-Z21 typical,,85032B/E,,85032F,,85054B,,New Kit 1,2012-05-25'. A sequence of two commas means that the preceding cal kit has no label assigned.  
 CORRection:CKIT:STANdard:CATalog? '85032B/E'  
 Query standards in cal kit named 85032B/E. Possible response: 'MOP,FOP,MSH,FSH,MMMT,FMMT,MFTH'  
 CORRection:CKIT:STANdard:LCATalog? 'New Kit 1','2012-05-25'  
 Query standards in user cal kit named New Kit 1 labelled 2012-05-25. Possible response: 'MOP,FOP,MSH(P1),FSH,MMMT,FMMT,MSM,FSM,MREF,FREF,MOSHORT2,FOSHORT2,MOSHORT3,FOSHORT3,MMTH,MMTH(P2P3)...' (P1 etc. denote restricted port assignments).
- Usage:** Query only
- Manual operation:** See "[Connector / Gender](#)" on page 463

---

**[SENSe<Ch>:]CORRection:CONNection:DELeTe <ConnectorName>**

Deletes a user-defined connector type named <ConnectorName>.

**Suffix:**

<Ch> Channel number

**Setting parameters:**

<ConnectorName> Name of the user-defined connectors, string parameter.

**Example:** See [\[SENSe<Ch>:\]CORRection:CONNection](#)

**Usage:** Setting only

**Manual operation:** See "[Connector / Gender](#)" on page 463

**[SENSe<Ch>:]CORRection:DATA:PARAmeter<Sfk>? [<SfkSettingType>[, <Index>]]**

Gets the settings of the active system error correction (or of the factory calibration, if no channel calibration is active).

**Suffix:**

<Ch> Number of the calibrated channel.

<Sfk> Number of the system error correction.  
Must be omitted or set to 1.

**Query parameters:**

<SfkSettingType> ACAL | START | STOP | POINTs | SPOWer | STYPE | BANDwidth | PDLY | RATTenuation | TYPE | PORTs | SPORT | THRoughs | TSTamp | LTSTamp | TVNA | MVNA | MTEST | CKIT | FSMode

The requested setting.

If no <SfkSettingType> is specified, the values for START, STOP, POINTs, SPOWer and STYPE are returned

**ACAL**

1 for automatic calibrations, 0 for manual calibrations

**START**

Start frequency (or CW frequency, if no frequency sweep is active)

**STOP**

Stop frequency (or CW frequency, if no frequency sweep is active)

**POINTs**

Number of points

**SPOWer**

Source power

**STYPE**

Sweep type or grid (LIN, LOG, SEGM)

**BANDwidth**

Measurement bandwidth

**PDLY**

Point delay (Meas Delay) for OSM

**RATTenuation**

Receiver attenuations: comma-separated list containing a value pair <port no.>,<rec. att.> (float,integer) for each of the involved

**PORTs**

**TYPE**

Calibration type (see <Type> parameter in [\[SENSe<Ch>:\]CORRection:COLLect\[:ACQUIRE\]:SElected](#) on page 844)

**PORTs**

The related test port numbers (comma-separated list of integers)

**THRoughs**

Measured Throughs: comma-separated list of directed port number pairs <pno1-pno2>

**TSTamp**

Timestamp in UTC

**LTSTamp**

Timestamp in local time

**CKIT**

For each port, the name of the used calibration kit is stored with the calibration.

The query can return one of the following:

**the cal kit name** (string)

if available and unique

**'Multiple'**

if cal kit names are available but not unique, i.e. if <PhyPt> was not specified and multiple cal kits were used (multi-port calcs with different connector types, merged calcs)

<Index>

Not used

**Example:**

SENSe:CORRection:DATA:PARAmeter?

Unrestricted query. Result looks like this:

100000,8500000000,201,-10,LIN

SENSe:CORRection:DATA:PARAmeter? START

...

SENSe:CORRection:DATA:PARAmeter? STYPE

Query settings one by one.

SENSe:CORRection:DATA:PARAmeter? RATTenuation

Query receiver attenuations. Result looks like this:

1,0.000000,2,0.000000

**Usage:**

Query only

**Manual operation:** See ["Apply"](#) on page 466

**[SENSe<Ch>:]CORRection:DATA:PARAmeter:COUNT?**

Gets the number of active system error corrections for channel <Ch>.

For the R&S ZNL/ZNLE the result is 0 (uncalibrated) or 1 (calibrated). The properties of the active system error correction can be queried using [\[SENSe<Ch>:\]CORRection:DATA:PARAmeter<Sfk>?](#).

**Suffix:**

<Ch> Channel number

**Usage:**

Query only

**[SENSe<Ch>:]CORRection:DATE?**

Returns the date and time when the active system error correction data for channel <Ch> was acquired (see example).

**Suffix:**

<Ch> Channel number of the calibrated channel

**Example:**

```
CORR:COLL:METH REFL1
```

Select a one-port normalization at port 1 as calibration type.

```
CORR:COLL OPEN1
```

Measure an open standard connected to port 1 and store the measurement results of this standard.

```
CORR:COLL:SAVE
```

Calculate the system error correction data and apply it to the active channel.

```
CORR:DATE?
```

Query the time when the system error correction became active.

The analyzer returns the date and time, e.g.

```
'03/20/11,18:30:39'
```

```
CORR:DATA:PAR?
```

Query the sweep settings for the calibration sweep. The analyzer returns the start and stop frequency, the number of points, source power, and the sweep type, e.g.

```
300000,80000000000,201,0,LIN.
```

```
CORR:SST?
```

Query the calibration status. The analyzer returns 'CAL OFF' (because the performed one-port calibration is not sufficient for the measured transmission S-parameter  $S_{21}$ ).

**Usage:** Query only

**Manual operation:** See "Apply" on page 466

**[SENSe<Ch>:]CORRection:EDELay:AUTO <Activate>**

Applies the [Auto Length](#)) function to the active trace of channel <Ch>.

Use [CALCulate<Chn>:STATistics:DOMain:USER](#) commands to limit the frequency range for the calculation.

**Suffix:**

<Ch> Channel number

**Setting parameters:**

<Activate> ONCE

Applies the auto length function.

**Example:**

```
*RST; :CORR:EDEL:AUTO ONCE
```

Reset the instrument and apply the auto length function to the default trace (Trc1 in channel 1).

**Usage:** Setting only

**Manual operation:** See ["Auto Length"](#) on page 502

---

**[SENSe<Ch>:]CORRection:EDELay<PhyPt>:DIElectric <Permittivity>**

Defines the permittivity for the offset correction at test port <PhyPt>.

**Suffix:**

<Ch> Channel number of the offset-corrected channel  
 <PhyPt> Port number of the analyzer

**Parameters:**

<Permittivity> Permittivity  
 Range: 1 to +1E+6  
 \*RST: 1.00062

**Example:** See [\[SENSe<Ch>:\]CORRection:EDELay<PhyPt>:ELENgth](#)

**Manual operation:** See ["Permittivity / Velocity Factor"](#) on page 501

---

**[SENSe<Ch>:]CORRection:EDELay<PhyPt>:DISTance <MechLength>**

Defines the offset parameter for test port <PhyPt> as a mechanical length.

**Suffix:**

<Ch> Channel number of the offset-corrected channel  
 <PhyPt> Port number of the analyzer

**Parameters:**

<MechLength> Mechanical length  
 Range: -3.402823466E+038 m to +3.4028234664E+038 m.  
 \*RST: 0 m  
 Default unit: m

**Example:** See [\[SENSe<Ch>:\]CORRection:EDELay<PhyPt>:ELENgth](#)

**Manual operation:** See ["Delay / Electrical Length / Mech. Length"](#) on page 500

---

**[SENSe<Ch>:]CORRection:EDELay<PhyPt>:ELENgth <ElecLength>**

Defines the offset parameter for test port <PhyPt> as an electrical length.

**Suffix:**

<Ch> Channel number of the offset-corrected channel  
 <PhyPt> Port number of the analyzer

**Parameters:**

<ElecLength> Electrical length  
 Range: -1E+9 m to +1E+9 m.  
 Increment: 1 mm  
 \*RST: 0 m  
 Default unit: m

**Example:**

```
CORR:EDEL2:ELEN 0.3
```

Define an electrical length of 30 cm for channel 1 and port no. 2.

```
CORR:EDEL2:DIST?; DIEL?
```

Query the values of the mechanical length and the permittivity at port 2. The mechanical length is equal to the electrical length divided by the square root of the permittivity; the latter is set to its default value. The response is 0.29990704322; 1.00062.

```
CORR:EDEL2?
```

Query the value of the delay at port 2. The delay is equal to the electrical length divided by the speed of light in the vacuum, so the response is 1.0006922856E-009.

```
CORR:LOSS2 2; LOSS2:FREQ 1.5 GHz; OFFS 3 dB
```

Define the offset loss parameters at port 2.

**Manual operation:** See "[Delay / Electrical Length / Mech. Length](#)" on page 500

**[SENSe<Ch>:]CORRection:EDELay<PhyPt>[:TIME] <Delay>**

Defines the offset parameter for test port <PhyPt> as a delay time.

**Suffix:**

<Ch> Channel number of the offset-corrected channel

<PhyPt> Port number of the analyzer

**Parameters:**

<Delay> Delay  
 Range: -3.40282346638529E+038 s to  
 +3.40282346638529E+038 s.  
 \*RST: 0 s  
 Default unit: s

**Example:** See [\[SENSe<Ch>:\]CORRection:EDELay<PhyPt>:ELENgth](#)

**Manual operation:** See "[Delay / Electrical Length / Mech. Length](#)" on page 500

**[SENSe:]CORRection:EDELay:VNETwork <Boolean>**

Changes the position of the offset calculation in the "Offset Embed" calculation chain.

**Parameters:**

<Boolean> **OFF (0)**  
 The offset is calculated **before** de-/embedding (default).

**ON (1)**  
 The offset is calculated **after** de-/embedding.

\*RST: 0

**Manual operation:** See "[Offset > Calculate after De-/Embed.](#)" on page 519

---

**[SENSe<Ch>:]CORRection:EWAVE[:STATe]** <Boolean>

Activates or deactivates the wave correction logic for wave quantities and ratios.

**Suffix:**

<Ch> Channel number

**Parameters:**

<Boolean> \*RST: ON (1)

---

**[SENSe<Ch>:]CORRection:LOSS<PhyPt>** <LossAtFrequency>

**[SENSe<Ch>:]CORRection:LOSS<PhyPt>:SECond** <LossAtFrequency>

These commands define the [offset loss](#) at the reference frequencies  $f_1$  and  $f_2$ .

The reference frequencies can be set using [\[SENSe<Ch>:\]CORRection:LOSS<PhyPt>:FREQUENCY](#) and [\[SENSe<Ch>:\]CORRection:LOSS<PhyPt>:SECond:FREQUENCY](#).

**Suffix:**

<Ch> Channel number

<PhyPt> Physical port number

**Parameters:**

<LossAtFrequency> Loss at reference frequency  
 Range: -200 dB to +200 dB  
 Increment: 0.001 dB  
 \*RST: 0 dB  
 Default unit: dB

**Manual operation:** See "[Loss at DC / Loss at 1st Freq / 1st Freq for Loss / Use 2nd Freq / Loss at 2nd Freq / 2nd Freq for Loss](#)" on page 492

---

**[SENSe<Ch>:]CORRection:LOSS:AUTO** <Activate>

Applies the [Auto Length and Loss](#)) function to the active trace of channel <Ch>.

Use [CALCulate<Chn>:STATistics:DOMain:USER](#) commands to limit the frequency range for the calculation.

**Suffix:**

<Ch> Channel number

**Setting parameters:**

<Activate> ONCE  
 Required constant

**Example:**

\*RST; :CORR:LOSS:AUTO ONCE  
 Reset the instrument and apply the "Auto Length and Loss" function to the default trace (Trc1 in channel 1).

**Usage:** Setting only

**Manual operation:** See "[Auto Length and Loss](#)" on page 506

---

---

**[SENSe<Ch>:]CORRection:LOSS<PhyPt>:FREQUency <RefFreq>**  
**[SENSe<Ch>:]CORRection:LOSS<PhyPt>:SECond:FREQUency <RefFreq>**

These commands define the reference frequencies  $f_1$  and  $f_2$  for the [offset loss](#) approximation.

The corresponding losses can be defined using [\[SENSe<Ch>:\]CORRection:LOSS<PhyPt>:OFFSet](#).

**Suffix:**

<Ch> Channel number  
 <PhyPt> Physical port number

**Parameters:**

<RefFreq> Reference frequency  
 Range: Frequency range of the analyzer model.  
 Increment: 1 MHz  
 \*RST: 1000000000 Hz (= 1 GHz)  
 Default unit: Hz

**Manual operation:** See "[Loss at DC / Loss at 1st Freq / 1st Freq for Loss / Use 2nd Freq / Loss at 2nd Freq / 2nd Freq for Loss](#)" on page 492

---

**[SENSe<Ch>:]CORRection:LOSS<PhyPt>:OFFSet <OffsetLoss>**

Defines the frequency-independent part (DC value) of the offset loss.

**Suffix:**

<Ch> Channel number of the offset-corrected channel  
 <PhyPt> Port number of the analyzer

**Parameters:**

<OffsetLoss> Frequency-independent part of the offset loss  
 Range: -200 dB to +200 dB  
 Increment: 0.001 dB  
 \*RST: 0 dB  
 Default unit: dB

**Example:** See [\[SENSe<Ch>:\]CORRection:EDELay<PhyPt>:ELEnGth](#)

**Manual operation:** See "[Loss at DC / Loss at 1st Freq / 1st Freq for Loss / Use 2nd Freq / Loss at 2nd Freq / 2nd Freq for Loss](#)" on page 492

---

**[SENSe<Ch>:]CORRection:LOSS<PhyPt>:SECond:STATe <Boolean>**

Defines whether the second reference frequency  $f_2$  is used for the [offset loss](#) approximation.

The second reference frequency and its associated loss value can be defined using [\[SENSe<Ch>:\]CORRection:LOSS<PhyPt>:SECond:FREQUency](#) and [\[SENSe<Ch>:\]CORRection:LOSS<PhyPt>:SECond](#).



**Suffix:**

|         |                      |
|---------|----------------------|
| <Ch>    | Channel number       |
| <PhyPt> | Physical port number |

**Parameters:**

|           |                                            |
|-----------|--------------------------------------------|
| <Boolean> | <b>OFF (0)</b><br>$f_2$ not used (default) |
|           | <b>ON (1)</b><br>$f_2$ used                |

**Manual operation:** See "[Loss at DC / Loss at 1st Freq / 1st Freq for Loss / Use 2nd Freq / Loss at 2nd Freq / 2nd Freq for Loss](#)" on page 492

**[SENSe<Ch>:]CORRection:OFFSet<PhyPt>[:STATe]** <Boolean>

Resets the offset parameters for all test ports to zero and the reference frequency to 1 GHz or queries whether any of the offset parameters are different from zero.

**Suffix:**

|         |                                                                                                               |
|---------|---------------------------------------------------------------------------------------------------------------|
| <Ch>    | Channel number of the offset-corrected channel                                                                |
| <PhyPt> | Port number of the analyzer. This numeric suffix is ignored; the command affects the parameters of all ports. |

**Parameters:**

|           |                                                                                                                                                                                                                                                                                                                                                                                         |
|-----------|-----------------------------------------------------------------------------------------------------------------------------------------------------------------------------------------------------------------------------------------------------------------------------------------------------------------------------------------------------------------------------------------|
| <Boolean> | The parameter function depends on whether the command is used as a setting command or as a query: For setting command:<br>ON - no effect<br>OFF - resets all length offsets to zero and the reference frequency to 1 GHz<br>For query:<br>1 - at least one length offset parameter is different from its default value<br>0 - all length offsets are zero / set to default<br>*RST: OFF |
|-----------|-----------------------------------------------------------------------------------------------------------------------------------------------------------------------------------------------------------------------------------------------------------------------------------------------------------------------------------------------------------------------------------------|

**Example:**

\*RST; :CORR:OFFS?

Reset the instrument and query whether the length offset parameters have been reset as well. The response is 0.

**Manual operation:** See "[Reset Offsets](#)" on page 492

**[SENSe<Ch>:]CORRection:OFFSet<PhyPt>:COMPensation[:STATe]** <Boolean>

Toggles length/loss/fixture compensation for physical port <PhyPt> ON/OFF.

**Suffix:**

|         |                      |
|---------|----------------------|
| <Ch>    | Channel number       |
| <PhyPt> | Physical port number |

**Parameters:**

<Boolean>                    ON (1): compensation active  
                                   OFF (0): compensation inactive

**Manual operation:**    See "[Active](#)" on page 491

**[SENSe<Ch>:]CORRection:OFFSet<PhyPt>:DFComp[:STATe]?**

Returns whether a direct fixture compensation has been carried out at port no. <PhyPt>. A direct fixture compensation resets the offset parameters to zero, the analyzer uses calculated transmission factors instead.

**Suffix:**

<Ch>                            Channel number of the offset-corrected channel  
 <PhyPt>                        Port number of the analyzer.

**Return values:**

<Boolean>                    1 - direct fixture compensation data used  
                                   0 - no direct fixture compensation data used

**Example:**

```
*RST; CORR:OFFS:DFC?
```

Reset the instrument and query whether the analyzer uses direct fixture compensation data at port 1. The response is 0.

**Usage:**                      Query only

**Manual operation:**    See "[Direct Compensation](#)" on page 503

**[SENSe<Ch>:]CORRection:STIMulus?**

Queries the stimulus values of the active calibration. A calibration must be selected before the command is executed; see example.

**Suffix:**

<Ch>                            Channel number of the calibrated channel

**Example:**

```
*RST; :CORR:COLL:METH:DEF 'Test',RShort,1
```

Select a one-port normalization at port 1 with a short standard as calibration type.

```
CORR:STIM?
```

Query the stimulus frequencies. The response contains 201 frequency values.

```
CORR:COLL:SEL SHOR,1
```

Measure a short standard connected to port 1 and store the measurement results of this standard.

```
CORR:COLL:SAVE:SEL
```

Calculate the system error correction data and apply it to the active channel.

**Usage:**                      Query only

**Manual operation:**    See "[Apply](#)" on page 466

**[SENSe<Chn>:]CORRection:SState?**

Returns the system error correction state label of the active trace in channel <Chn>. The response is a string variable containing the calibration state label in the trace list ('CAL', 'CAI', 'CAL OFF' ..; see [Chapter 9.5.4, "Calibration Labels"](#), on page 260).

**Suffix:**

<Chn> Channel number used to identify the active trace

**Example:**

See [\[SENSe<Ch>:\]CORRection:DATE?](#)

**Usage:**

Query only

**Manual operation:** See ["Apply"](#) on page 466

**[SENSe:]COUPle...**

The [\[SENSe:\]COUPle...](#) commands select the sweep mode.

**[SENSe<Ch>:]COUPle <Mode>**

Determines the order of partial measurements and sweeps (see [Chapter 9.1.4.1, "Partial Measurements and Driving Mode"](#), on page 190).

**Suffix:**

<Ch> Channel number. This suffix is ignored; the sweep mode applies to all channels in the active channel setup.

**Parameters:**

<Mode> ALL | AUTO | NONE

AUTO – automatic mode: fast sweeps are performed in alternated driving mode, slower sweeps in chopped mode

ALL – chopped driving mode, complete all partial measurements before proceeding to the next sweep point

NONE – alternated driving mode on, reverse the order of partial measurements and sweeps

\*RST: NONE

**Example:**

COUP NONE

Activate the alternated driving mode.

TRIG:LINK 'PPO'

Set the triggered measurement sequence equal to one partial measurement. Each trigger event starts one partial measurement for all sweep points.

**Manual operation:** See ["Driving Mode"](#) on page 487

**[SENSe:]FREQuency...**

The [\[SENSe:\]...](#) commands set frequency-related parameters, especially the measurement and display ranges for the different sweep types. The frequency ranges for the different instrument models are listed below; for more details refer to the data sheet.

Table 11-18: Frequency ranges of R&amp;S ZNL analyzers

| Frequency settings | Start, Stop      | Center             | Span                  |
|--------------------|------------------|--------------------|-----------------------|
| R&S ZNL3           | 5 kHz to 3.0 GHz | >5 kHz to <3.0 GHz | 1 Hz to 2.999995 GHz  |
| R&S ZNL4           | 5 kHz to 4.5 GHz | >5 kHz to <4.5 GHz | 1 Hz to 4.499995 GHz  |
| R&S ZNL6           | 5 kHz to 6 GHz   | >5 kHz to <6 GHz   | 1 Hz to 5.999995 GHz  |
| R&S ZNL14          | 5 kHz to 14 GHz  | >5 kHz to <14 GHz  | 1 Hz to 13.999995 GHz |
| R&S ZNL20          | 5 kHz to 20 GHz  | >5 kHz to <20 GHz  | 1 Hz to 19.999995 GHz |

Table 11-19: Frequency ranges of R&amp;S ZNLE analyzers

| Frequency settings                  | Start, Stop        | Center               | Span                |
|-------------------------------------|--------------------|----------------------|---------------------|
| R&S ZNLE3                           | 1 MHz to 3.0 GHz   | >1 MHz to < 3 GHz    | 1 Hz to 2.999 GHz   |
| R&S ZNLE3 with<br>R&S ZNLE-B100     | 100 kHz to 3.0 GHz | >100 kHz to < 3 GHz  | 1 Hz to 2.9999 GHz  |
| R&S ZNLE4                           | 1 MHz to 4.5 GHz   | >1 MHz to < 4 GHz    | 1 Hz to 4.499 GHz   |
| R&S ZNLE4 with<br>R&S ZNLE-B100     | 100 kHz to 4.5 GHz | >100 kHz to < 4 GHz  | 1 Hz to 4.4999 GHz  |
| R&S ZNL/ZNLE6                       | 1 MHz to 6 GHz     | >1 MHz to < 6 GHz    | 1 Hz to 5.999 GHz   |
| R&S ZNL/ZNLE6 with<br>R&S ZNLE-B100 | 100 kHz to 6.0 GHz | >100 kHz to < 6 GHz  | 1 Hz to 5.9999 GHz  |
| R&S ZNL/ZNLE6                       | 1 MHz to 14 GHz    | >1 MHz to < 14 GHz   | 1 Hz to 13.999 GHz  |
| R&S ZNL/ZNLE6 with<br>R&S ZNLE-B100 | 100 kHz to 14 GHz  | >100 kHz to < 14 GHz | 1 Hz to 13.9999 GHz |
| R&S ZNL/ZNLE6                       | 1 MHz to 18 GHz    | >1 MHz to < 18 GHz   | 1 Hz to 17.999 GHz  |
| R&S ZNL/ZNLE6 with<br>R&S ZNLE-B100 | 100 kHz to 18 GHz  | >100 kHz to < 18 GHz | 1 Hz to 13.9999 GHz |

|                                         |     |
|-----------------------------------------|-----|
| [SENSe<Ch>:]FREQUENCY[:CW].....         | 876 |
| [SENSe<Ch>:]FREQUENCY:FIXed.....        | 876 |
| [SENSe<Ch>:]FREQUENCY:CENTer.....       | 877 |
| [SENSe<Ch>:]FREQUENCY:SBANd.....        | 878 |
| [SENSe<Ch>:]FREQUENCY:SEGMENT:AXIS..... | 878 |
| [SENSe<Ch>:]FREQUENCY:SPAN.....         | 879 |
| [SENSe<Ch>:]FREQUENCY:START.....        | 879 |
| [SENSe<Ch>:]FREQUENCY:STOP.....         | 879 |

[SENSe<Ch>:]FREQUENCY[:CW] <FixedFreq>

[SENSe<Ch>:]FREQUENCY:FIXed <FixedFreq>

Defines the fixed (Continuous Wave, CW) frequency for all sweep types operating at fixed frequency ("Time", "CW Mode"). The two command forms

[SENSe<Ch>:]FREQUENCY[:CW] and [SENSe<Ch>:]FREQUENCY:FIXed are equivalent.

The frequency ranges are listed in [Table 11-18](#).

**Note:** [SENSE<Ch>:]FREQUENCY[:CW]|:FIXed is equivalent to SOURCE<Ch>:FREQUENCY<PhyPt>[:CW]|:FIXed. Source and receiver frequency are always equal; the four commands overwrite each other.

**Suffix:**

<Ch> Channel number

**Parameters:**

<FixedFreq> Fixed stimulus and analyzer frequency  
 \*RST: 1 GHz  
 Default unit: Hz

**Example:**

```
FUNC "XTime:POW:A1"
Activate a time sweep and select the wave quantity a1 as measured parameter for channel and trace no. 1.
FREQ:CW 100MHz
Set the CW frequency to 100 MHz.
```

**Manual operation:** See "[CW Frequency](#)" on page 297

**[SENSE<Ch>:]FREQUENCY:CENTer <CenterFreq>**

Defines the center of the measurement and display range for a frequency sweep (sweep range). The default center frequency is the center of the analyzer's maximum frequency range:  $(f_{MIN} + f_{MAX})/2$ . The range is listed in table [Table 11-18](#).

**Suffix:**

<Ch> Channel number

**Parameters:**

<CenterFreq> Center frequency of the sweep  
 Increment: 0.1 kHz  
 Default unit: Hz

**Example:**

```
*RST; :SYST:FREQ? MIN; :SYST:FREQ? MAX
Query the frequency range of the analyzer.
FREQ:CENT 100MHz
Set center frequency to 100 MHz.
FREQ:SPAN 50000
Set frequency span to 50 kHz.
```

**Manual operation:** See "[Start Frequency / Stop Frequency / Center Frequency / Span Frequency](#)" on page 296

**Note:** The measurement range defined by means of the center frequency and the current span ([SENSE<Ch>:]FREQUENCY:SPAN) must not exceed the allowed frequency range of the analyzer. If necessary, the span is reduced to  $\min(\text{<CenterFreq>} - f_{MIN}, f_{MAX} - \text{<CenterFreq>})$ .

**[SENSe<Ch>:]FREQUENCY:SBANd <Sideband>**

Defines whether the analyzer measures with a local oscillator frequency LO below or above the RF input frequency.

**Tip:** In a segmented frequency sweep, it is possible to set the sideband (SBANd) parameter individually for each segment; see [SENSe<Ch>:]SEGMENT<Seg>:DEFine. The [SENSe<Ch>:]FREQUENCY:SBANd setting is global and not valid for segmented sweeps. The two sideband settings do not overwrite each other.

**Note:** For the R&S ZNLE only AUTO mode is supported.

**Suffix:**

<Ch> Channel number. This suffix is ignored; the setting applies to all channels in the active channel setup.

**Parameters:**

<Sideband> POSitive | NEGative | AUTO

**POSitive**

LO > RF; the LO frequency is always above the measured RF frequency.

**NEGative**

LO < RF; the LO frequency is always below the measured RF frequency.

**AUTO**

The analyzer auto-selects the LO frequency, depending on the receiver (RF) frequency.

\*RST: AUTO

**Example:**

\*RST; :SWE:TYPE?; :FREQ:SBAN?

Query the \*RST values for the sweep type and the sideband setting. The response is LIN (linear frequency sweep) and AUTO (automatic setting of the LO frequency).

**Manual operation:** See "Image Suppr." on page 487

**[SENSe<Ch>:]FREQUENCY:SEGMENT:AXIS <Scale>**

Selects either frequency based or point based x-axis for segmented sweeps.

**Suffix:**

<Ch> Channel number

**Parameters:**

<Scale> POINT | FREQUENCY

**Example:**           SENSE:SEGMent:INSert 1MHZ, 1.1MHZ, 101, -21DBM,  
0.5S, 0, 10KHZ  
SENSE:SEGMent:INSert 2MHZ, 3MHZ, 101, -21DBM,  
0.5S, 0, 10KHZ  
Create two sweep segments with different frequency spans,  
each with 101 sweep points.  
SENSE:SEGMent:FREQuency:AXIS POINT  
Select the point based frequency axis. The first 101 sweep  
points are distributed over the left half of the diagram, the sec-  
ond 101 points over the right half.

**Manual operation:** See "[Seg X-Axis](#)" on page 316

### [SENSe<Ch>:]FREQuency:SPAN <Span>

Defines the width (span) of the measurement and display range for a frequency sweep (sweep range). The default span equals to the maximum frequency range of the analyzer:  $f_{MAX} - f_{MIN}$ .

The range depends on the instrument model; see [Table 11-18](#).

#### Suffix:

<Ch>                   Channel number

#### Parameters:

<Span>                Frequency span of the sweep  
Increment: 0.1 kHz  
Default unit: Hz

**Example:**           See [\[SENSe<Ch>:\]FREQuency:CENTer](#)

**Manual operation:** See "[Start Frequency / Stop Frequency / Center Frequency / Span Frequency](#)" on page 296

**Note:** The measurement range defined by means of the span and the current center frequency ([\[SENSe<Ch>:\]FREQuency:CENTer](#)), must not exceed the allowed frequency range of the analyzer. If necessary, the center frequency is adjusted to  $f_{MIN} + \langle \text{Span} \rangle / 2$  or  $f_{MAX} - \langle \text{Span} \rangle / 2$ .

### [SENSe<Ch>:]FREQuency:START <StartFreq>

### [SENSe<Ch>:]FREQuency:STOP <StopFreq>

These commands defines the start and stop frequency for a frequency sweep. The values also define the display range in a Cartesian diagram. The default start and stop frequencies equal to the minimum and maximum frequency of the analyzer.

The ranges are listed in [Table 11-18](#).

#### Suffix:

<Ch>                   Channel number

**Parameters:**

<StopFreq> Start and stop frequency of the sweep  
 Increment: 0.1 kHz  
 Default unit: Hz

**Example:**

```
*RST; FREQ:STAR 100000
```

Activate a frequency sweep and set the start frequency to 100 kHz.

```
FREQ:STOP 10MHz
```

Set the stop frequency to 10 MHz.

**Manual operation:** See "[Start Frequency / Stop Frequency / Center Frequency / Span Frequency](#)" on page 296

**Note:** If the start frequency entered is greater than the current stop frequency, the stop frequency is set to the start frequency plus the minimum frequency span (`[SENSe<Ch>:]FREQuency:SPAN`).

If the stop frequency entered is smaller than the current start frequency, the start frequency is set to the stop frequency minus the minimum frequency span.

**[SENSe:]HARMonic...**

Implements functions related to harmonic grids for time domain transformation.

|                                                    |     |
|----------------------------------------------------|-----|
| <code>[SENSe&lt;Ch&gt;:]HARMonic?</code> .....     | 880 |
| <code>[SENSe&lt;Ch&gt;:]HARMonic:AUTO</code> ..... | 880 |

**[SENSe<Ch>:]HARMonic?**

Queries whether the current frequency grid is harmonic.

**Suffix:**

<Ch> Channel number

**Return values:**

<arg0>

**Usage:** Query only

**Manual operation:** See "[Is the Current Grid Harmonic?](#)" on page 347

**[SENSe<Ch>:]HARMonic:AUTO <arg0>**

Turns the "Automatic Harmonic Grid" function ON or OFF.

**Suffix:**

<Ch> Channel number

**Parameters:**

<arg0> \*RST: ON

**Options:** R&S ZNL-K2

**Manual operation:** See "[Automatic Harmonic Grid](#)" on page 348



**[SENSe:]LPORt...**

The [SENSe:]LPORt... commands define the reference impedances of the balanced ports.

|                                                |     |
|------------------------------------------------|-----|
| [SENSe<Ch>:]LPORt<LogPt>:ZCOMmon.....          | 881 |
| [SENSe<Ch>:]LPORt<LogPt>:ZDIFferent.....       | 881 |
| [SENSe<Ch>:]LPORt<LogPt>:ZDEFault[:STATe]..... | 882 |

**[SENSe<Ch>:]LPORt<LogPt>:ZCOMmon** <RealPart>[, <ImaginaryPart>]

**[SENSe<Ch>:]LPORt<LogPt>:ZDIFferent** <RealPart>[, <ImaginaryPart>]

These commands specify the complex common mode and differential mode reference impedances for the balanced (logical) port numbered <LogPt>.

Use [SENSe<Ch>:]LPORt<LogPt>:ZDEFault[:STATe] to toggle between configured and default reference impedances.

**Suffix:**

<Ch> Channel number

<LogPt> Logical port number. The logical ports must be defined using `SOURce<Ch>:LPORt<LogPt> <PhysicalPort1>, <PhysicalPort2>`. An n port analyzer supports a maximum of n/2 (n even) or (n - 1)/2 (n odd) logical ports.

**Parameters:**

<RealPart> Real part of the port impedance.

Range: 1 mΩ to 10 MΩ

\*RST: ZCOMmon: 25 Ω; ZDIFferent: 100 Ω (real impedances)

Default unit: Ohm

<ImaginaryPart> Imaginary part of the port impedance; may be omitted to define a real impedance.

Range: - 10 MΩ to 10 MΩ

\*RST: 0 Ω (real impedances)

Default unit: Ohm

**Example:**

```
*RST; :CALC:PAR:DEL 'TRC1'
```

Reset the analyzer and delete the (default) trace for channel no. 1.

```
SOUR:LPOR1 1,2
```

Combine the physical ports no. 1 and 2 to define the balanced (logical) port no. 1.

```
LPOR1:ZDIF 27, 2
```

Specify a complex differential mode reference impedance of  $27\Omega + j \cdot 2\Omega$  for the defined port.

**Manual operation:** See "Single Ended Mode / Common Mode / Differential Mode" on page 382

**[SENSe<Ch>:]LPORt<LogPt>:ZDEFault[:STATe]** <arg0>

Allows to toggle between default and renormalized reference impedance(s) for logical port <LogPt>.

**Suffix:**

<Ch> Channel number  
 <LogPt> Logical port number

**Parameters:**

<arg0> ON (1): Use default impedance(s)  
 OFF (0): Use the redefined impedances defined via  
[\[SENSe<Ch>:\]PORT<PhyPt>:ZREFeRence](#) for single-ended  
 or via [\[SENSe<Ch>:\]LPORt<LogPt>:ZCOMMon](#) and  
[\[SENSe<Ch>:\]LPORt<LogPt>:ZDIFFerent](#) for balanced  
 logical ports

**Manual operation:** See "Use Default" on page 383

**[SENSe:]PORT...**

The [\[SENSe:\]PORT...](#) commands define the reference impedances at the physical ports.

**[SENSe<Ch>:]PORT<PhyPt>:ZREFeRence** <RealPart>[, <ImaginaryPart>]

Specifies the complex reference impedance for the physical port numbered <PhyPt> (impedance renormalization).

Use [\[SENSe<Ch>:\]LPORt<LogPt>:ZDEFault\[:STATe\]](#) to toggle between configured and default reference impedances.

**Suffix:**

<Ch> Channel number  
 <PhyPt> Physical port number

**Parameters:**

<RealPart> Real part of the port impedance.  
 Range: 1 mΩ to 10 MΩ  
 \*RST: Default reference impedance of the connector family assigned to the port (real impedance, e.g. 50 Ω).  
 Default unit: Ohm

<ImaginaryPart> Imaginary part of the port impedance. This part may be omitted to define a real impedance.  
 Range: - 10 MΩ to 10 MΩ  
 \*RST: Default reference impedance of the connector family assigned to the port (real impedance, e.g. 50 Ω).  
 Default unit: Ohm

- Example:** `PORT2:ZREF 52, 2`  
Specify a complex reference impedance of  $52 \Omega + j * 2 \Omega$  for the (physical) port no. 2.  
`CALC:TRAN:IMP:RNOR PWAV`  
Select renormalization of port impedances according to the power waves theory.
- Manual operation:** See "[Single Ended Mode / Common Mode / Differential Mode](#)" on page 382

**[SENSe:]POWer...**

The [SENSe:]POWer... commands configure the optional receiver step attenuators (see [Chapter 9.7.6, "Receiver Step Attenuators"](#), on page 291).

[SENSe<Ch>:]POWer:ATTenuation.....883

**[SENSe<Ch>:]POWer:ATTenuation <arg0>[, <arg1>]**

Sets an attenuation factor for the received waves. This command is available if at least one of the [Receiver Step Attenuators](#) is installed.

**Suffix:**

<Ch> Channel number

**Parameters:**

<arg0> Physical port number  
Instead of port numbers 1 and 2 you can also use the constants ARECeiver and BRECeiver, respectively.

Default unit: n/a

<arg1> Attenuation factor for the received wave.

Range: 0 dB, 10 dB, 20 dB, 30 dB. The analyzer rounds any entered value below the maximum attenuation to the closest step.

\*RST: 0 dB

Default unit: dB

- Example:** `POW:ATT AREC, 10`  
Set an attenuation factor of 10 dB for the waves received at test port 1 and channel no. 1. The other test ports and channels are not affected.

**Manual operation:** See "[Step Attenuators](#)" on page 298

**[SENSe:]SEGMENT<Seg>...**

The [SENSe:]SEGMENT<Seg>... commands define all channel settings for a segmented frequency sweep. A segmented sweep is activated via [SENSe<Ch>:

]SWEep:TYPE SEGMENT.



The commands in this subsystem do not accept the step parameters UP and DOWN. Numeric values can be entered directly or using the DEFault, MINimum, MAXimum parameters.

|                                                             |     |
|-------------------------------------------------------------|-----|
| [SENSe<Ch>:]SEGMENT:COUNT?                                  | 884 |
| [SENSe<Ch>:]SEGMENT<Seg>[:STATe]                            | 885 |
| [SENSe<Ch>:]SEGMENT<Seg>:ADD                                | 885 |
| [SENSe<Ch>:]SEGMENT<Seg>:BWIDth[:RESolution]                | 886 |
| [SENSe<Ch>:]SEGMENT<Seg>:BWIDth[:RESolution]:CONTRol        | 886 |
| [SENSe<Ch>:]SEGMENT<Seg>:BWIDth[:RESolution]:SELEct         | 887 |
| [SENSe<Ch>:]SEGMENT<Seg>:BWIDth[:RESolution]:SELEct:CONTRol | 887 |
| [SENSe<Ch>:]SEGMENT<Seg>:DEFine                             | 888 |
| [SENSe<Ch>:]SEGMENT<Seg>:DEFine:SELEct                      | 890 |
| [SENSe<Ch>:]SEGMENT<Seg>:DELEte:ALL                         | 890 |
| [SENSe<Ch>:]SEGMENT<Seg>:DELEte[:DUMMy]                     | 891 |
| [SENSe<Ch>:]SEGMENT<Seg>:FREQUency:CENTer?                  | 891 |
| [SENSe<Ch>:]SEGMENT<Seg>:FREQUency:SPAN?                    | 891 |
| [SENSe<Ch>:]SEGMENT<Seg>:FREQUency:STARt                    | 892 |
| [SENSe<Ch>:]SEGMENT<Seg>:FREQUency:STOP                     | 892 |
| [SENSe<Ch>:]SEGMENT<Seg>:INSert                             | 892 |
| [SENSe<Ch>:]SEGMENT<Seg>:INSert:SELEct                      | 894 |
| [SENSe<Ch>:]SEGMENT<Seg>:POWer[:LEVel]                      | 895 |
| [SENSe<Ch>:]SEGMENT<Seg>:POWer[:LEVel]:CONTRol              | 895 |
| [SENSe<Ch>:]SEGMENT<Seg>:SWEep:DWELl                        | 896 |
| [SENSe<Ch>:]SEGMENT<Seg>:SWEep:DWELl:CONTRol                | 897 |
| [SENSe<Ch>:]SEGMENT<Seg>:SWEep:POINts                       | 897 |
| [SENSe<Ch>:]SEGMENT<Seg>:SWEep:TIME                         | 898 |
| [SENSe<Ch>:]SEGMENT<Seg>:SWEep:TIME:CONTRol                 | 899 |
| [SENSe<Ch>:]SEGMENT<Seg>:SWEep:TIME:SUM?                    | 899 |

### [SENSe<Ch>:]SEGMENT:COUNT?

Returns the number of sweep segments in the channel including all segments that are switched off ([SENSe<Ch>:]SEGMENT<Seg>[:STATe] OFF).

#### Suffix:

<Ch> Channel number

#### Example:

```
SEGM:ADD
Create a new sweep segment no. 1 in channel no. 1 using
default settings.
SEGM OFF
Disable the measurement in the created sweep segment.
SEGM:COUN?
Query the number of segments.
```

**Usage:** Query only

**Manual operation:** See "Table Columns" on page 318

**[SENSe<Ch>:]SEGMENT<Seg>[:STATe] <Boolean>**

Activates or deactivates the sweep segment <Seg>. Sweep points belonging to inactive segments only are not measured.

**Suffix:**

<Ch> Channel number  
 <Seg> Sweep segment number

**Parameters:**

<Boolean> ON | OFF - activates or deactivates the measurement in sweep segment <Seg>.  
 \*RST: ON

**Example:**

```
SEGM:ADD
Create a new sweep segment no. 1 in channel no. 1 using
default settings.
SEGM OFF
Disable the measurement in the created sweep segment.
```

**Manual operation:** See ["Table Columns"](#) on page 318

**[SENSe<Ch>:]SEGMENT<Seg>:ADD**

Inserts a new sweep segment using default channel settings ("Insert New Segment"). The added segment covers the frequency interval between the maximum frequency of the existing sweep segments and the stop frequency of the entire sweep range.

**Tip:** Use `[SENSe<Ch>:]SEGMENT<Seg>:INSert` to create a segment with specific channel settings.

**Suffix:**

<Ch> Channel number  
 <Seg> Sweep segment number. Segment numbers must be sequential. If n segments exist already, the added segment must have the segment number n+1.

**Example:**

```
SEGM:INS 1MHZ, 1.5MHZ, 111, -21DBM, 0.5S, 0,
10KHZ
Create a sweep segment with a sweep range between 1.0 MHz
and 1.5 MHz.
SEGM2:ADD
Create a second sweep segment. The frequency range of the
second segment will be between 1.5 MHz and the maximum fre-
quency of the analyzer.
```

**Usage:** Event

**Manual operation:** See ["Add / Insert / Delete / Delete All"](#) on page 319

---

**[SENSe<Ch>:]SEGMent<Seg>:BWIDth[:RESolution]** <ResBandwidth>

Defines the IF bandwidth of the analyzer (Meas. Bandwidth). Values between 1 Hz and 500 kHz can be set.

Bandwidths can be set in 1 – 1.5 – 2 – 3 – 5 – 7 steps. The analyzer rounds up any entered value between these steps and rounds down values exceeding the maximum bandwidth.

At the same time, the command activates separate bandwidth setting in all sweep segments (`[SENSe<Ch>:]SEGMent<Seg>:BWIDth[:RESolution]:CONTRol ON`).

**Suffix:**

<Ch> Channel number  
 <Seg> Sweep segment number

**Parameters:**

<ResBandwidth> IF bandwidth  
 Range: See above  
 Increment: 1-1.5-2-3-5-7 steps  
 \*RST: 10 kHz  
 Default unit: Hz

**Example:** See `[SENSe<Ch>:]SEGMent<Seg>:BWIDth[:RESolution]:CONTRol`

**Manual operation:** See "Optional Columns" on page 321

---

**[SENSe<Ch>:]SEGMent<Seg>:BWIDth[:RESolution]:CONTRol** <Boolean>

Selects common or independent "Meas. Bandwidth" settings for the sweep segments.

**Suffix:**

<Ch> Channel number  
 <Seg> Sweep segment number. This suffix is ignored; the setting controls the whole segmented sweep.

**Parameters:**

<Boolean> ON – use independent bandwidth settings, to be defined via `[SENSe<Ch>:]SEGMent<Seg>:BWIDth[:RESolution]`.  
 OFF – reset the bandwidth in all sweep segments to the bandwidth for unsegmented sweeps, defined via `[SENSe<Ch>:]BWIDth[:RESolution]`. ON will not restore the previous values.  
 The parameter is automatically switched to ON when a bandwidth is entered using `[SENSe<Ch>:]SEGMent<Seg>:BWIDth[:RESolution]`.  
 \*RST: OFF

**Example:**                    \*RST; :SENS:SEGM:ADD  
                                   Create a new sweep segment no. 1 in channel no. 1 using  
                                   default settings and thus 10 kHz measurement bandwidth.  
                                   SEGM:BWID 1 MHZ  
                                   Increase the IF bandwidth to 1 MHz.  
                                   SEGM:BWID:CONT OFF  
                                   Couple the bandwidths in all segments and reset the bandwidth  
                                   in segment no. 1 to the initial value.

**Manual operation:** See "Optional Columns" on page 321

**[SENSe<Ch>:]SEGMENT<Seg>:BWIDth[:RESolution]:SELEct <Selectivity>**

Defines the "Selectivity" of the IF filter used in sweep segment no. <Seg>. At the same time, the command activates individual selectivity settings for all sweep segments (`[SENSe<Ch>:]SEGMENT<Seg>:BWIDth[:RESolution]:SELEct:CONTROL ON`).

**Note:** For the R&S ZNLE always NORMAL selectivity filters are used. Trying to set the selectivity will result in an execution error.

**Suffix:**

<Ch>                            Channel number  
 <Seg>                           Sweep segment number

**Parameters:**

<Selectivity>                NORMAL | MEDIUM | HIGH  
 NORMAL - IF filter with normal selectivity and shortest settling time.  
 MEDIUM - IF filter with steeper edges and longer settling time.  
 HIGH - IF filter with highest selectivity but longest settling time.

**Example:**                    See `[SENSe<Ch>:]SEGMENT<Seg>:BWIDth[:RESolution]:SELEct:CONTROL`

**Manual operation:** See "Optional Columns" on page 321

**[SENSe<Ch>:]SEGMENT<Seg>:BWIDth[:RESolution]:SELEct:CONTROL <Boolean>**

Selects common or independent "Selectivity" settings for the individual sweep segments.

**Suffix:**

<Ch>                            Channel number  
 <Seg>                           Sweep segment number. This suffix is ignored; the setting controls the whole segmented sweep.

**Parameters:**

&lt;Boolean&gt;

ON - use independent selectivity settings, to be defined via `[SENSe<Ch>:]SEGMENT<Seg>:BWIDth[:RESolution]:SElect`.

OFF - reset the selectivity in all sweep segments to the selectivity for unsegmented sweeps, defined via `[SENSe<Ch>:]BWIDth[:RESolution]:SElect`. ON will not restore the previous values.

The parameter is automatically switched to ON when a selectivity is entered using `[SENSe<Ch>:]SEGMENT<Seg>:BWIDth[:RESolution]:SElect`.

\*RST: OFF

**Example:**

\*RST; :SEGM:ADD

Create a new sweep segment no. 1 in channel no. 1 using default settings and thus NORMAl selectivity.

SEGM:BWID:SEL HIGH

Change the selectivity to HIGH.

BWID:SEL?

Query the (default) selectivity for unsegmented sweeps. The response is NORM.

SEGM:BWID:SEL:CONT OFF

Couple the selectivities in all segments and reset the selectivity in segment no. 1 to the unsegmented value NORMAl.

**Manual operation:** See "[Optional Columns](#)" on page 321

---

**[SENSe<Ch>:]SEGMENT<Seg>:DEFine** <StartFreq>, <StopFreq>, <Points>, <Power>, <SegmentTime>|<MeasDelay>, <Unused>, <MeasBandwidth>[, <LO>, <Selectivity>, <FreqSweepMode>]

Creates or re-defines a sweep segment no. <Seg> with specific channel settings.

Entry of the first seven numeric parameters is mandatory; no default values are provided. All settings except <LO> can be changed for existing segments using other commands of the `[SENSe<Ch>:]SEGMENT<Seg> . . .` subsystem.

**Note:** Use `[SENSe<Ch>:]SEGMENT<Seg>:ADD` to create a segment with default channel settings. Use `[SENSe<Ch>:]SEGMENT<Seg>:INSert` (no query) to insert a new segment into the current segment list.

**Suffix:**

&lt;Ch&gt;

Channel number

&lt;Seg&gt;

Sweep segment number. Segment numbers must be sequential. The specified segment number must be smaller or equal to the number of existing segments plus 1.

If segment number <Seg> already exists, it is replaced by the new segment.



**Parameters:**

|                 |                                                                                                                                                                                                                                                                                                                                                                                                                                                      |
|-----------------|------------------------------------------------------------------------------------------------------------------------------------------------------------------------------------------------------------------------------------------------------------------------------------------------------------------------------------------------------------------------------------------------------------------------------------------------------|
| <StartFreq>     | Start frequency of the segment; see <a href="#">[SENSe&lt;Ch&gt; : ] SEGMENT&lt;Seg&gt; : FREQUENCY : START</a> .<br>Default unit: Hz                                                                                                                                                                                                                                                                                                                |
| <StopFreq>      | Stop frequency of the segment; see <a href="#">[SENSe&lt;Ch&gt; : ] SEGMENT&lt;Seg&gt; : FREQUENCY : STOP</a> .<br>Default unit: Hz                                                                                                                                                                                                                                                                                                                  |
| <Points>        | Number of sweep points in the segment. See <a href="#">[SENSe&lt;Ch&gt; : ] SEGMENT&lt;Seg&gt; : SWEEP : POINTS</a> .                                                                                                                                                                                                                                                                                                                                |
| <Power>         | Internal source power in the segment. See <a href="#">[SENSe&lt;Ch&gt; : ] SEGMENT&lt;Seg&gt; : POWER [ : LEVEL ]</a> .<br>Default unit: dBm                                                                                                                                                                                                                                                                                                         |
| <SegmentTime>   | Duration of the sweep in the segment. See <a href="#">[SENSe&lt;Ch&gt; : ] SEGMENT&lt;Seg&gt; : SWEEP : TIME</a> . In the setting <a href="#">[SENSe&lt;Ch&gt; : ] SEGMENT&lt;Seg&gt; : INSERT : SELECT DWELL</a> , this parameter is replaced by <MeasDelay>.<br>Range: Depending on other channel settings. AUTO activates automatic sweep time setting in the segment, which is equivalent to the minimum sweep time possible.<br>Default unit: s |
| <MeasDelay>     | Delay for each partial measurement in the segment. See <a href="#">[SENSe&lt;Ch&gt; : ] SEGMENT&lt;Seg&gt; : SWEEP : DWELL</a> . In the setting <a href="#">[SENSe&lt;Ch&gt; : ] SEGMENT&lt;Seg&gt; : INSERT : SELECT SWTIME</a> , this parameter is replaced by <SegmentTime>.                                                                                                                                                                      |
| <Unused>        | Ignored parameter (for compatibility with R&S ZVR analyzers). Should be set to the default value 0.                                                                                                                                                                                                                                                                                                                                                  |
| <MeasBandwidth> | IF bandwidth in the segment. See <a href="#">[SENSe&lt;Ch&gt; : ] SEGMENT&lt;Seg&gt; : BANDWIDTH [ : RESOLUTION ]</a> .<br>Default unit: Hz                                                                                                                                                                                                                                                                                                          |
| <LO>            | POSitive   NEGative   AUTO<br>Position of the local oscillator frequency LO relative to the RF frequency. In remote control this parameter must be set when a sweep segment is created.<br>See <a href="#">[SENSe&lt;Ch&gt; : ] FREQUENCY : SBAND</a> .                                                                                                                                                                                              |
| <Selectivity>   | NORMal   MEDium   HIGH<br>Selectivity of the IF filter. See <a href="#">[SENSe&lt;Ch&gt; : ] SEGMENT&lt;Seg&gt; : BANDWIDTH [ : RESOLUTION ] : SELECT</a> .                                                                                                                                                                                                                                                                                          |
| <Mode>          | AUTO<br>Ignored.                                                                                                                                                                                                                                                                                                                                                                                                                                     |

<FreqSweepMode> STEPped  
Frequency sweep mode; must be set to `Stepped`.

**Example:** `SEGM:ADD`  
Create a new sweep segment no. 1 in channel no. 1 using default settings.  
`SEGM:DEF?`  
Query the channel settings for the new segment. A possible response is  
`1000000000,2000000000,51,-300,0.0044625,0,10000,AUTO,NORM,STEP.`

**Manual operation:** See "[Optional Columns](#)" on page 321

### **[SENSe<Ch>:]SEGMENT<Seg>:DEFine:SELect <TimeRef>**

Defines whether the sweep time of a new segment, i.e. numeric parameter no. 5 of the command `[SENSe<Ch>:]SEGMENT<Seg>:DEFine`, is entered as a segment sweep time ("Segment Time") or as a measurement delay ("Meas Delay").

**Suffix:**

<Ch> Channel number  
<Seg> Sweep segment number

**Parameters:**

<TimeRef> SWTime | DWELI  
SWTime - use segment sweep time.  
DWELI - use measurement delay.

**Example:** `SEGM1:DEF:SEL DWEL`  
Select the measurement delay to determine the sweep time in a new sweep segment no. 1.  
`SEGM1:DEF 1MHZ, 1.5MHZ, 111, -21DBM, 0.01S, 0, 10KHZ`  
Create a sweep segment with a sweep range between 1.0 MHz and 1.5 MHz and a measurement delay of 10 ms.  
`SEGM1:SWE:TIME?`  
Query the sweep time in the new segment.

**Manual operation:** See "[Optional Columns](#)" on page 321

### **[SENSe<Ch>:]SEGMENT<Seg>:DELete:ALL**

Deletes all sweep segments in the channel. `[SENSe<Ch>:]SEGMENT<Seg>:DELete[:DUMMy]` deletes a single segment.

**Suffix:**

<Ch> Channel number  
<Seg> Sweep segment number. This suffix is ignored; the command deletes all segments.

**Example:**           SEGM:ADD  
Create a new sweep segment no. 1 in channel no. 1 using default settings.  
SEGM:DEL:ALL  
Delete the created segment and all segments in the channel created before.

**Usage:**            Event

**Manual operation:** See "Add / Insert / Delete / Delete All" on page 319

### [SENSe<Ch>:]SEGMENT<Seg>:DELEte[:DUMMy]

Deletes the specified (single) sweep segment. [SENSe<Ch>:]SEGMENT<Seg>:DELEte:ALL deletes all segments in the channel.

**Suffix:**

<Ch>                    Channel number  
<Seg>                   Sweep segment number

**Example:**           SEGM:ADD  
Create a new sweep segment no. 1 in channel no. 1 using default settings.  
SEGM:DEL  
Delete the created segment.

**Manual operation:** See "Add / Insert / Delete / Delete All" on page 319

### [SENSe<Ch>:]SEGMENT<Seg>:FREQUency:CENTer? [SENSe<Ch>:]SEGMENT<Seg>:FREQUency:SPAN?

These commands return the center frequency and the span (width) of sweep segment no. <Seg>.

**Suffix:**

<Ch>                    Channel number  
<Seg>                   Sweep segment number

**Example:**           SEGM:INS 1MHZ, 1.5MHZ, 111, -21DBM, 0.5S, 0, 10KHZ  
Create a sweep segment with a sweep range between 1.0 MHz and 1.5 MHz.  
SEGM:FREQ:CENT? SPAN?  
Query the center frequency and span of the created segment.  
The response is 1250000;500000.

**Usage:**            Query only

**Manual operation:** See "Table Columns" on page 318

**Note:** The frequency range of the sweep segment can be changed via [SENSe<Ch>:]SEGMENT<Seg>:FREQUency:START and [SENSe<Ch>:]SEGMENT<Seg>:FREQUency:STOP.

---

```
[SENSe<Ch>:]SEGMent<Seg>:FREQUency:STARt <StartFreq>
[SENSe<Ch>:]SEGMent<Seg>:FREQUency:STOP <StopFreq>
```

These commands define the start and stop frequency of sweep segment no. <Seg>.

The sweep segments must be within the frequency range of the R&S ZNL/ZNLE; see [Table 11-18](#).

**Suffix:**

<Ch> Channel number  
 <Seg> Sweep segment number

**Parameters:**

<StopFreq> Start or stop frequency of the sweep.  
 Increment: 0.1 kHz  
 Default unit: Hz

**Example:**

```
SEGM:INS 1MHZ, 1.5MHZ, 111, -21DBM, 0.5S, 0,
10KHZ
```

Create a sweep segment with a sweep range between 1.0 MHz and 1.5 MHz.

```
SEGM:FREQ:STAR?; STOP?
```

Query the start and stop frequency of the created segment. The response is 1000000;1500000.

**Manual operation:** See "[Table Columns](#)" on page 318

**Note:** If the start frequency entered is greater than the current stop frequency, the stop frequency is set to the start frequency. If the stop frequency entered is smaller than the current start frequency, the start frequency is set to the stop frequency.

---

```
[SENSe<Ch>:]SEGMent<Seg>:INSert <StartFreq>, <StopFreq>, <Points>, <Power>,
<SegmentTime>|<MeasDelay>, <Unused>, <MeasBandwidth>[, <LO>,
<Selectivity>, <Mode>, <FreqSweepMode>]
```

Adds a new sweep segment no. <Seg> with specific channel settings.

Entry of the first seven numeric parameters is mandatory; no default values are provided. All settings except <LO> can be changed for existing segments using other commands of the [SENSe<Ch>:]SEGMent<Seg>... subsystem.

**Note:** Use [SENSe<Ch>:]SEGMent<Seg>:ADD to create a segment with default channel settings. Use [SENSe<Ch>:]SEGMent<Seg>:DEFine to change or query all settings of an existing segment.

**Suffix:**

<Ch> Channel number

|                    |                                                                                                                                                                                                                                                                                                                                                                                                                                                                                                                                                                                     |
|--------------------|-------------------------------------------------------------------------------------------------------------------------------------------------------------------------------------------------------------------------------------------------------------------------------------------------------------------------------------------------------------------------------------------------------------------------------------------------------------------------------------------------------------------------------------------------------------------------------------|
| <Seg>              | <p>Sweep segment number. Segment numbers must be sequential. The specified segment number must be smaller or equal to the number of existing segments plus 1.</p> <p>If one or more sweep segments with segment numbers &lt;Seg&gt; or larger exist in the current channel, then all these existing segment numbers are incremented by 1 and the new segment is inserted as segment no. &lt;Seg&gt;.</p> <p>Note that &lt;Seg&gt; defaults to 1, so<br/> <code>[SENSE&lt;Ch&gt;:]SEGMENT:INSERT</code> inserts a new segment 1, shifting the existing segments one position up.</p> |
| <b>Parameters:</b> |                                                                                                                                                                                                                                                                                                                                                                                                                                                                                                                                                                                     |
| <StartFreq>        | <p>Start frequency of the segment. See <code>[SENSE&lt;Ch&gt;:]SEGMENT&lt;Seg&gt;:FREQUENCY:START</code>.</p> <p>Default unit: Hz</p>                                                                                                                                                                                                                                                                                                                                                                                                                                               |
| <StopFreq>         | <p>Stop frequency of the segment; see <code>[SENSE&lt;Ch&gt;:]SEGMENT&lt;Seg&gt;:FREQUENCY:STOP</code>.</p> <p>Default unit: Hz</p>                                                                                                                                                                                                                                                                                                                                                                                                                                                 |
| <Points>           | <p>Number of sweep points in the segment. See <code>[SENSE&lt;Ch&gt;:]SEGMENT&lt;Seg&gt;:SWEPT:POINTS</code>.</p>                                                                                                                                                                                                                                                                                                                                                                                                                                                                   |
| <Power>            | <p>Internal source power in the segment. See <code>[SENSE&lt;Ch&gt;:]SEGMENT&lt;Seg&gt;:POWER[:LEVEL]</code>.</p> <p>Default unit: dBm</p>                                                                                                                                                                                                                                                                                                                                                                                                                                          |
| <SegmentTime>      | <p>Duration of the sweep in the segment. See <code>[SENSE&lt;Ch&gt;:]SEGMENT&lt;Seg&gt;:SWEPT:TIME</code>. In the setting <code>[SENSE&lt;Ch&gt;:]SEGMENT&lt;Seg&gt;:INSERT:SELECT DWELL</code>, this parameter is replaced by &lt;MeasDelay&gt;.</p> <p>Range: Depending on other channel settings. AUTO activates automatic sweep time setting in the segment, which is equivalent to the minimum sweep time possible.</p> <p>Default unit: s</p>                                                                                                                                 |
| <MeasDelay>        | <p>Delay for each partial measurement in the segment. See <code>[SENSE&lt;Ch&gt;:]SEGMENT&lt;Seg&gt;:SWEPT:DWELL</code>. In the setting <code>[SENSE&lt;Ch&gt;:]SEGMENT&lt;Seg&gt;:INSERT:SELECT SWTime</code>, this parameter is replaced by &lt;SegmentTime&gt;.</p>                                                                                                                                                                                                                                                                                                              |
| <Unused>           | <p>Ignored parameter (for compatibility with R&amp;S ZVR analyzers). Should be set to the default value 0.</p>                                                                                                                                                                                                                                                                                                                                                                                                                                                                      |
| <MeasBandwidth>    | <p>IF bandwidth in the segment. See <code>[SENSE&lt;Ch&gt;:]SEGMENT&lt;Seg&gt;:BWIDTH[:RESOLUTION]</code>.</p> <p>Default unit: Hz</p>                                                                                                                                                                                                                                                                                                                                                                                                                                              |

|                 |                                                                                                                                                                                                                             |
|-----------------|-----------------------------------------------------------------------------------------------------------------------------------------------------------------------------------------------------------------------------|
| <LO>            | POSitive   NEGative   AUTO<br>Position of the local oscillator frequency LO relative to the RF frequency. In remote control this parameter must be set when a sweep segment is created.<br>See [SENSe<Ch>:]FREQuency:SBANd. |
| <Selectivity>   | NORMal   MEDium   HIGH<br>Selectivity of the IF filter. See [SENSe<Ch>:]SEGMENT<Seg>:BWIDth[:RESolution]:SElect.                                                                                                            |
| <Mode>          | AUTO<br>Ignored.                                                                                                                                                                                                            |
| <FreqSweepMode> | STEPped<br>Frequency sweep mode; must be set to STEPped.                                                                                                                                                                    |

**Example:**

```
SEGM:INS 1MHZ, 1.5MHZ, 111, -21DBM, 0.5S, 0, 10KHZ
```

Create a sweep segment with a sweep range between 1.0 MHz and 1.5 MHz.

```
SEGM2:ADD
```

Create a second sweep segment. The frequency range of the second segment will be between 1.5 MHz and the maximum frequency of the analyzer.

**Manual operation:** See "Add / Insert / Delete / Delete All" on page 319

---

#### [SENSe<Ch>:]SEGMENT<Seg>:INSert:SElect <TimeRef>

Defines whether the sweep time of a new segment, i.e. numeric parameter no. 5 of the command [SENSe<Ch>:]SEGMENT<Seg>:INSert, is entered as a segment sweep time ("Segment Time") or as a measurement delay ("Meas Delay").

#### Suffix:

|       |                      |
|-------|----------------------|
| <Ch>  | Channel number       |
| <Seg> | Sweep segment number |

#### Parameters:

|           |                                                                                      |
|-----------|--------------------------------------------------------------------------------------|
| <TimeRef> | SWTime   DWELI<br>SWTime - use segment sweep time.<br>DWELI - use measurement delay. |
| *RST:     | SWTime                                                                               |

**Example:** `SEGM1:INS:SEL DWEL`  
 Select the meas. delay to determine the sweep time in a new sweep segment no. 1.  
`SEGM1:INS 1MHZ, 1.5MHZ, 111, -21DBM, 0.01S, 0, 10KHZ`  
 Create a sweep segment with a sweep range between 1.0 MHz and 1.5 MHz and a meas. delay of 10 ms.  
`SEGM1:SWE:TIME?`  
 Query the sweep time in the new segment.

**Manual operation:** See "[Optional Columns](#)" on page 321

### **[SENSe<Ch>:]SEGMENT<Seg>:POWER[:LEVEL] <IntSourcePow>**

Defines the power of the internal signal source in sweep segment no. <Seg>. At the same time, the command activates separate power control in all sweep segments (`[SENSe<Ch>:]SEGMENT<Seg>:POWER[:LEVEL]:CONTROL`).

**Suffix:**

<Ch> Channel number  
 <Seg> Sweep segment number

**Parameters:**

<IntSourcePow> Internal source power  
 Range: -300 dBm to +200 dBm. The usable power range is frequency-dependent; refer to the data sheet.  
 \*RST: -10 dBm  
 Default unit: dBm

**Example:** `SEGM:ADD`  
 Create a new sweep segment no. 1 in channel no. 1 using default settings and thus -10 dBm internal source power.  
`SEGM:POW -20`  
 Decrease the power to -20 dBm.

**Manual operation:** See "[Optional Columns](#)" on page 321

### **[SENSe<Ch>:]SEGMENT<Seg>:POWER[:LEVEL]:CONTROL <Boolean>**

Selects common or independent internal source "Power" settings for the sweep segments.

**Suffix:**

<Ch> Channel number  
 <Seg> Sweep segment number. This suffix is ignored; the setting controls the whole segmented sweep.

**Parameters:**

&lt;Boolean&gt;

ON – use independent power settings, to be defined via

`[SENSe<Ch>:]SEGMENT<Seg>:POWer[:LEVel]`.OFF – reset the power in all sweep segments to the power for unsegmented sweeps, defined via `SOURce<Ch>:``POWer<PhyPt>[:LEVel] [:IMMediate] [:AMPLitude]`. ON will not restore the previous values.The parameter is automatically switched to ON when a segment power is entered using `[SENSe<Ch>:]SEGMENT<Seg>:``POWer[:LEVel]`.

\*RST: OFF

**Example:**

SEGM:ADD

Create a new sweep segment no. 1 in channel no. 1 using default settings and thus -10 dBm internal source power.

SEGM:POW -20

Decrease the power to -20 dBm.

SEGM:POW:CONT OFF

Couple the powers in all segments and reset the power in segment no. 1 to the initial value.

**Manual operation:** See "Optional Columns" on page 321**[SENSe<Ch>:]SEGMENT<Seg>:SWEep:DWELI <MeasDelay>**

Defines the delay time for each partial measurement in sweep segment no. <Seg> ("Meas. Delay"). If coupling of the segments is switched on (`[SENSe<Ch>:]SEGMENT<Seg>:SWEep:DWELI:CONTrol ON`), the delay is valid for all sweep segments in the current channel.

**Suffix:**

&lt;Ch&gt; Channel number

&lt;Seg&gt; Sweep segment number

**Parameters:**

&lt;MeasDelay&gt;

Measurement delay before each partial measurement. Changing the delay leaves the number of points unchanged but has an

impact on the duration of the sweep (`[SENSe<Ch>:]SEGMENT<Seg>:SWEep:TIME`).

Range: 0 s to 2500 s

\*RST: 0 s

Default unit: s



**Example:**

```
SEGM:ADD
```

Create a new sweep segment no. 1 in channel no. 1 using default settings.

```
SEGM:SWE:DWEL 1 MS
```

Set the meas. delay in segment no. 1 to 1 ms.

```
SEGM:DEF? Response:
```

```
300000,8000000000,51,-300,0.056559,0,10000,POS,NORM
```

Query the channel parameters for sweep segment 1. The response value for the segment sweep time (olive) implicitly contains the defined meas. delay.

**Manual operation:** See "[Optional Columns](#)" on page 321

### [SENSe<Ch>:]SEGMent<Seg>:SWEep:DWELI:CONTRol <Boolean>

Selects common or independent "Meas. Delay" settings for the sweep segments.

**Suffix:**

<Ch> Channel number.

<Seg> Sweep segment number. This suffix is ignored; the command controls the whole segmented sweep.

**Parameters:**

<Boolean>

ON – use independent delay settings, to be defined via

```
[SENSe<Ch>:]SEGMent<Seg>:SWEep:DWELI.
```

OFF – reset the delay in all sweep segments to the delay for unsegmented sweeps, defined via [SENSe<Ch>:]SWEep:DWELI.

The parameter is automatically switched to ON when a meas. delay time is entered using [SENSe<Ch>:]SEGMent<Seg>:SWEep:DWELI.

```
*RST: OFF
```

**Example:**

```
SEGM:ADD
```

Create a new sweep segment no. 1 in channel no. 1 using default settings and thus 0 s meas. delay.

```
SEGM:SWE:DWELI 0.1
```

Increase the meas. delay to 0.1 s.

```
SEGM:SWE:DWELI:CONTR OFF
```

Couple the meas. delay in all segments and reset the delay in segment no. 1 to the initial value of 0 s.

**Manual operation:** See "[Optional Columns](#)" on page 321

### [SENSe<Ch>:]SEGMent<Seg>:SWEep:POINts <SegPoint>

Defines the total number of measurement points in sweep segment no. <Seg>.

**Suffix:**

<Ch> Channel number

|                          |                                                                                                                                                                                |
|--------------------------|--------------------------------------------------------------------------------------------------------------------------------------------------------------------------------|
| <Seg>                    | Sweep segment number                                                                                                                                                           |
| <b>Parameters:</b>       |                                                                                                                                                                                |
| <SegPoint>               | Number of points in the segment                                                                                                                                                |
| Range:                   | 1 to 100001. 1 is allowed if start and stop frequencies are equal.                                                                                                             |
| *RST:                    | 51                                                                                                                                                                             |
| <b>Example:</b>          | <pre>SEGM:ADD</pre> <p>Create a new sweep segment no. 1 in channel no. 1 using default settings.</p> <pre>SEGM:SWE:POIN 401</pre> <p>Increase the number of points to 401.</p> |
| <b>Manual operation:</b> | See <a href="#">"Table Columns"</a> on page 318                                                                                                                                |

### **[SENSe<Ch>:]SEGMENT<Seg>:SWEep:TIME <SegSweepTime>**

Sets the duration of the sweep in sweep segment no. <Seg> ("Segment Time"). At the same time, the command activates separate sweep time setting in all sweep segments ([\[SENSe<Ch>:\]SEGMENT<Seg>:SWEep:TIME:CONTROL ON](#)).

#### **Suffix:**

|       |                      |
|-------|----------------------|
| <Ch>  | Channel number       |
| <Seg> | Sweep segment number |

#### **Parameters:**

|                |                                                                                                                                                                                                                                                                                                                                                                                                                                                                                                                                                                                                                                                                                                                                             |
|----------------|---------------------------------------------------------------------------------------------------------------------------------------------------------------------------------------------------------------------------------------------------------------------------------------------------------------------------------------------------------------------------------------------------------------------------------------------------------------------------------------------------------------------------------------------------------------------------------------------------------------------------------------------------------------------------------------------------------------------------------------------|
| <SegSweepTime> | <p>Segment time. The minimum segment time depends on the other channel settings, in particular on the number of points (<a href="#">[SENSe&lt;Ch&gt;:]SEGMENT&lt;Seg&gt;:SWEep:POINTS</a>), the IF bandwidth (<a href="#">[SENSe&lt;Ch&gt;:]SEGMENT&lt;Seg&gt;:BWIDth[:RESolution]</a>) and the delay for each partial measurement (<a href="#">[SENSe&lt;Ch&gt;:]SEGMENT&lt;Seg&gt;:SWEep:DWELL</a>). The maximum is 1000 s. Changing the duration leaves the number of points unchanged but directly affects the delay.</p> <p>Range: Minimum value to 1000 s</p> <p>*RST: Minimum value, depending on the channel settings. This default value corresponds to automatic sweep time setting in manual control.</p> <p>Default unit: s</p> |
|----------------|---------------------------------------------------------------------------------------------------------------------------------------------------------------------------------------------------------------------------------------------------------------------------------------------------------------------------------------------------------------------------------------------------------------------------------------------------------------------------------------------------------------------------------------------------------------------------------------------------------------------------------------------------------------------------------------------------------------------------------------------|

#### **Example:**

```
SEGM:ADD
```

Create a new sweep segment no. 1 in channel no. 1.

```
SEGM:SWE:TIME 0.1
```

Increase the segment sweep time to 0.1 s.

```
SEGM:SWE:TIME:SUM?
```

Query the total duration of the segmented sweep. The response is 0.1, because there is only one sweep segment.

**Manual operation:** See ["Optional Columns"](#) on page 321

**[SENSe<Ch>:]SEGMENT<Seg>:SWEep:TIME:CONTROL <Boolean>**

Selects common or independent "Segment Sweep Time" settings for the sweep segments.

**Suffix:**

<Ch> Channel number

<Seg> Sweep segment number. This suffix is ignored; the command controls the whole segmented sweep.

**Parameters:**

<Boolean>

ON – use independent segment sweep time settings, to be defined via `[SENSe<Ch>:]SEGMENT<Seg>:SWEep:TIME`.

OFF – reset the segment sweep time in all sweep segments to the segment sweep time for unsegmented sweeps, defined via `[SENSe<Ch>:]SWEep:TIME`. ON will not restore the previous values.

The parameter is automatically switched to ON when a segment sweep time is entered using `[SENSe<Ch>:]SEGMENT<Seg>:SWEep:TIME` or if the channel settings in a sweep segment require a sweep time larger than the unsegmented sweep time.

\*RST: OFF

**Example:**

```
SEGM:ADD
```

Create a new sweep segment no. 1 in channel no. 1.

```
SEGM:SWE:TIME 0.1
```

Increase the segment sweep time to 0.1 s.

```
SEGM:SWE:TIME:CONT OFF
```

Couple the sweep times in all segments and reset the sweep time in segment no. 1 to the initial value.

**Manual operation:** See "Optional Columns" on page 321

**[SENSe<Ch>:]SEGMENT<Seg>:SWEep:TIME:SUM?**

Returns the total duration of the segmented sweep, calculated as the sum of the sweep times of the individual segments (`[SENSe<Ch>:]SEGMENT<Seg>:SWEep:TIME`).

**Suffix:**

<Ch> Channel number.

<Seg> Sweep segment number. This suffix is ignored; the command returns the sum of all segments.

**Example:**

See `[SENSe<Ch>:]SEGMENT<Seg>:SWEep:TIME`

**Usage:**

Query only

**Manual operation:** See "Optional Columns" on page 321

**[SENSe:]SWEep...**

The [SENSe:]SWEep... commands provide general settings to control the sweep. Most of the settings have an impact on the sweep time.

|                                     |     |
|-------------------------------------|-----|
| [SENSe:]SWEep:COUNT:ALL.....        | 900 |
| [SENSe<Ch>:]SWEep:COUNT.....        | 900 |
| [SENSe<Ch>:]SWEep:DWELI.....        | 901 |
| [SENSe<Ch>:]SWEep:DWELI:IPOint..... | 901 |
| [SENSe<Ch>:]SWEep:POINTs.....       | 902 |
| [SENSe<Ch>:]SWEep:STEP.....         | 902 |
| [SENSe<Ch>:]SWEep:TIME.....         | 903 |
| [SENSe<Ch>:]SWEep:TIME:AUTO.....    | 904 |
| [SENSe<Ch>:]SWEep:TYPE.....         | 905 |
| [SENSe<Chn>:]SWEep:SRCPort.....     | 906 |

**[SENSe:]SWEep:COUNT:ALL <Sweep>**

Defines the number of sweeps to be measured in single sweep mode (INITiate<Ch>:CONTinuous OFF). The setting is applied to all channels. Use [SENSe<Ch>:]SWEep:COUNT to define the sweep count for a single channel.

**Setting parameters:**

<Sweep>            Number of consecutive sweeps to be measured.  
 Range:            1 to 100000  
 \*RST:            1

**Example:**            See [Chapter 11.6.2.4, "Data Handling"](#), on page 978.

**Usage:**                Setting only

**Manual operation:**    See ["Sweeps"](#) on page 328

**[SENSe<Ch>:]SWEep:COUNT <Sweep>**

Defines the channel-specific number of sweeps to be measured and buffered in single sweep mode (INITiate<Ch>:CONTinuous OFF). Use [SENSe:]SWEep:COUNT:ALL to define the sweep count for all channels.

**Suffix:**

<Ch>                Channel number

**Parameters:**

<Sweep>            Number of consecutive sweeps to be measured and buffered.  
 Range:            1 to 100000  
 \*RST:            1

**Example:**            See [CALCulate<Chn>:DATA:NSweep:FIRSt?](#)

**Manual operation:**    See ["Sweeps"](#) on page 328

**[SENSe<Ch>:]SWEep:DWELI <MeasDelay>**

Defines the "Meas. Delay" before each partial measurement or the first partial measurement (see [SENSe<Ch>:]SWEep:DWELI:IPOint). Setting a delay disables the automatic calculation of the (minimum) sweep time (see [SENSe<Ch>:]SWEep:TIME:AUTO).

**Suffix:**

<Ch> Channel number

**Parameters:**

<MeasDelay> Measurement delay before each partial measurement. Changing the delay leaves the number of points unchanged but has an impact on the duration of the sweep ([SENSe<Ch>:]SWEep:TIME).

Range: 0 s to 13680 s

\*RST: 0 s

Default unit: s

**Example:**

\*RST

Reset the instrument, activating a frequency sweep with the S-parameter  $S_{21}$  as a measurement result for channel and trace no. 1.

SWEep:TIME?

Query total sweep time.

SWEep:DWEL 1

SWEep:DWEL:IPOint ALL

Set a delay of 1 s for each partial measurement.

SWE:TIME?

Query total sweep time. The time is extended by the delay times the total number of sweep points (one partial measurement per sweep point required).

**Manual operation:** See "Meas Delay" on page 311

**[SENSe<Ch>:]SWEep:DWELI:IPOint <InsertionPoints>**

Defines whether the measurement delay (previously defined via [SENSe<Ch>:]SWEep:DWELI) is inserted before all partial measurements or before the first partial measurement only.

**Suffix:**

<Ch> Channel number

**Parameters:**

<InsertionPoints> ALL | FIRSt

Insertion before all or before the first partial measurement

\*RST: ALL

**Example:**

See [SENSe<Ch>:]SWEep:DWELI

**Manual operation:** See ["All Partial Meas'ments / First Partial Meas'ment"](#) on page 312

---

**[SENSe<Ch>:]SWEep:POINTS <SweepPoint>**

Defines the total number of measurement points per sweep ("Number of Points").

Values between 1 and 100,001 can be set.

**Suffix:**

<Ch> Channel number 1

**Parameters:**

<SweepPoint> Number of points per sweep

Range: see above

\*RST: 201

**Example:**

\*RST

Reset the instrument, activating a frequency sweep with 201 sweep points.

SWE:TIME?

Query total sweep time.

SWE:POIN 2010

Multiply the (default) number of points by 10.

SWE:TIME?

Query total sweep time again. The analyzer estimates a sweep time that is also multiplied by 10.

**Manual operation:** See ["Number of Points"](#) on page 297

---

**[SENSe<Ch>:]SWEep:STEP <StepSize>**

Sets the distance between two consecutive sweep points in a (non-segmented) linear frequency sweep.

**Suffix:**

<Ch> Channel number

**Parameters:**

&lt;StepSize&gt;

Frequency step size.

The step size is equal to the current sweep span divided by the number of sweep points minus one (see [\[SENSe<Ch>:\]FREQuency:SPAN?](#) and [\[SENSe<Ch>:\]SWEep:POINts?](#), respectively). See also the description of manual control and the program example below.

Range: Depends on the current sweep span and the maximum number of sweep points: "Span Frequency" / (max. "Number of Points" – 1) ≤ "Freq Step Size" ≤ "Span Frequency"

\*RST: Depends on the analyzer model. The default step size is equal to the default sweep span of the analyzer divided by the default number of sweep points minus one.

Default unit: Hz

**Example:**

\*RST; :SWE:STEP?

Query the default step size. Currently for all analyzers the default sweep span is the full frequency range and the default number of points is 201. Hence the response is (max. frequency - min. frequency) / 200.

SWE:STEP UP

Increase the step size.

FREQ:STOP?; :SWE:POIN?

Query the stop frequency of the sweep and the number of points. Increasing the step size has changed both values.

**Manual operation:** See "[Freq Step Size](#)" on page 310

**[SENSe<Ch>:]SWEep:TIME <SweepDuration>**

Sets the duration of the sweep ("Sweep Time"). Setting a sweep time disables the automatic calculation of the (minimum) sweep time; see [\[SENSe<Ch>:\]SWEep:TIME:AUTO](#).

**Note:** The sweep time is ignored for the sweep types "Time" and "CW Mode" ([\[SENSe<Ch>:\]SWEep:TYPE](#)).

**Suffix:**

&lt;Ch&gt;

Channel number

**Parameters:**

<SweepDuration> Sweep time. The minimum possible sweep time depends on the other channel settings, in particular on the number of points (`[SENSe<Ch>:]SWEep:POINTs`), the IF bandwidth (`[SENSe<Ch>:]BWIDth[:RESolution]`) and the measurement delay for each partial measurement (`[SENSe<Ch>:]SWEep:DWELl`). Changing the duration leaves the number of points unchanged but directly affects the delay.

Range: Between minimum sweep time (for current channel settings) and 100000 s

\*RST: Minimum sweep time (for \*RST channel settings)

Default unit: s

**Example:**

```
SWE:TIME 1
Set a total sweep time of 1 s.
SWE:DWEL?
Query the delay for each partial measurement.
SWE:TIME 2
Increase the total sweep time to 2 s.
SWE:DWEL?
Query the meas. delay for each partial measurement again. The
delay is increased by 1 s divided by the total number of partial
measurements per sweep.
```

**Manual operation:** See "[Sweep Time / Auto](#)" on page 311

**[SENSe<Ch>:]SWEep:TIME:AUTO <Boolean>**

When enabled, the (minimum) sweep time is calculated internally using the other channel settings and zero delay (`[SENSe<Ch>:]SWEep:DWELl`).

**Note:** The automatically calculated sweep duration is ignored for the sweep types "Time" and "CW Mode" (`[SENSe<Ch>:]SWEep:TYPE`).

**Suffix:**

<Ch> Channel number

**Parameters:**

<Boolean> ON | OFF - turn the automatic calculation of the sweep time on or off.  
OFF is also set if the sweep duration or delay is set explicitly using `[SENSe<Ch>:]SWEep:TIME` or `[SENSe<Ch>:]SWEep:DWELl`.

\*RST: ON

**Example:**

```
SWE:TIME 1
Set a total sweep time of 1 s.
SWE:TIME:AUTO?
A query returns the value 1.
```

**Manual operation:** See "[Sweep Time / Auto](#)" on page 311



**[SENSe<Ch>:]SWEep:TYPE <Format>**

Selects the sweep type, i.e. the sweep variable (frequency/time) and the position of the sweep points across the sweep range.

**Suffix:**

<Ch> Channel number.

**Parameters:**

<Format> LINear | LOGarithmic | CW | POINT | SEGment

**LINear**

Linear frequency sweep at constant source power

(**SOURce<Ch>:POWer<PhyPt>[:LEVel] [:IMMediate] [:AMPLitude]**). The stimulus frequency

(**[SENSe<Ch>:]FREQuency: . . .**) is swept in equidistant steps over the frequency range. In a Cartesian diagram, the x-axis is a linear frequency axis.

**LOGarithmic**

Logarithmic frequency sweep. The frequency is swept in equidistant steps on a logarithmic scale. In a Cartesian diagram, the x-axis is a logarithmic frequency axis.

**CW**

Time sweep. The measurement is performed at constant frequency (**SOURce<Ch>:FREQuency<PhyPt>:FIXed**) and source power (**SOURce<Ch>:POWer<PhyPt>[:LEVel] [:IMMediate] [:AMPLitude]**) and repeated over a specified period of time at constant time intervals.

**POINT**

CW mode sweep, time sweep triggered according to the current trigger settings.

SEGment - segmented frequency sweep. The sweep range is composed of several continuous frequency ranges or single frequency points defined by means of the commands in the **[SENSe<Ch>:]SEGment<Seg> . . . subsystem**.

\*RST: LINear

**Example:**

\*RST

Reset the analyzer, activating a linear frequency sweep.

SWE:TYPE LOG

Change to a logarithmic frequency sweep, resetting the stimulus values of the sweep points.

**Manual operation:** See "[Lin Freq](#)" on page 312

**[SENSe<Chn>:]SWEep:SRCPort <Port>**

Sets/gets the source port for the stimulus signal. The setting acts on the active trace. The effect of the drive port selection depends on the measurement parameter associated to the active trace:

- If an S-parameter  $S_{<out><in>}$  is measured, the second port number index  $<in>$  (input port of the DUT = drive port of the analyzer) is set equal to the selected drive port: Drive port selection affects the measured quantity.
- If a wave quantity or a ratio is measured, the drive port is independent of the measured quantity:

**Suffix:**

<Chn> Channel number used to identify the active trace

**Parameters:**

<Port> Logical port number

\*RST: 1

**Example:**

```
CALC4:PAR:SDEF "Ch4Tr1", "A1"
```

Create channel 4 and a trace named "Ch4Tr1" to measure the wave quantity  $a_1$ . The trace automatically becomes the active trace.

```
SENS4:SWE:SRCP 2
```

Select drive port 2 for the active trace.

```
CALC4:PAR:MEAS? "Ch4Tr1"
```

Query the measurement result for "Ch4Tr1". The response is 'A1D2SAM'.

**11.5.2.14 SOURce Commands**

The `SOURce . . .` commands affect the source settings of the R&S ZNL/ZNLE.

**SOURce:FREQUENCY...**

The `SOURce:FREQUENCY . . .` commands configure the sources for frequency conversion measurements and control the frequency and power of the internal signal source.

|                                                                  |     |
|------------------------------------------------------------------|-----|
| <code>SOURce&lt;Ch&gt;:FREQUENCY&lt;PhyPt&gt;[:CW]</code> .....  | 906 |
| <code>SOURce&lt;Ch&gt;:FREQUENCY&lt;PhyPt&gt;:FIXed</code> ..... | 906 |

**SOURce<Ch>:FREQUENCY<PhyPt>[:CW]** <FixedFreq>

**SOURce<Ch>:FREQUENCY<PhyPt>:FIXed** <FixedFreq>

Defines the fixed (Continuous Wave, CW) frequency for all sweep types operating at fixed frequency ("Time", "CW Mode"). The two command forms

`SOURce<Ch>:FREQUENCY<PhyPt>:CW` and

`SOURce<Ch>:FREQUENCY<PhyPt>:FIXed` are equivalent.

The frequency ranges are listed in [Table 11-18](#).

**Note:** `SOURce<Ch>:FREQuency<PhyPt>[:CW]|:FIXed` is equivalent to `[SENSE<Ch>:]FREQuency[:CW]|:FIXed`. Source and receiver frequency are always equal; the four commands overwrite each other.

**Suffix:**

`<Ch>` Channel number

`<PhyPt>` Test port number of the analyzer. This suffix is ignored because the selected frequency applies to all source ports in the active channel.

**Parameters:**

`<FixedFreq>` Fixed stimulus and analyzer frequency.

\*RST: 1 GHz  
Default unit: Hz

**Example:**

```
FUNC "XTIME:POW:A1"
```

Activate a time sweep and select the wave quantity  $a_1$  as measured parameter for channel and trace no. 1.

```
FREQ:CW 100MHz
```

Set the CW frequency to 100 MHz.

**Manual operation:** See "[CW Frequency](#)" on page 297

**SOURce:LPORt...**

The `SOURce:LPORt...` commands define the logical port configuration (balanced ports, renumbered single-ended ports).

|                                                              |     |
|--------------------------------------------------------------|-----|
| <code>SOURce&lt;Ch&gt;:LPORt&lt;LogPt&gt;</code> .....       | 907 |
| <code>SOURce&lt;Ch&gt;:LPORt&lt;LogPt&gt;:CLEar</code> ..... | 908 |

**SOURce<Ch>:LPORt<LogPt> <PhysicalPort>[, <PhysicalPort>]**

Assigns the logical port number `<LogPt>` either to the single-ended physical port `<PhysicalPort1>` or to a pair of physical ports `<PhysicalPort1>,<PhysicalPort2>`, at the same time defining them as balanced port.

**Important:**

- All required logical ports (balanced and single ended) must be created explicitly.
- A balanced port configuration generally introduces a new set of mixed mode measured quantities. Therefore the traces must be redefined when a balanced port is created. To avoid any inconsistencies the analyzer deletes all traces when `SOURce<Ch>:LPORt<LogPt>` is used.
- It is essential to complete the logical port assignment before defining other port properties such as common or differential mode impedances: whenever a logical port is created using `SOURce<Ch>:LPORt<LogPt>`, the parameters of all existing logical ports are reset.

**Suffix:**

`<Ch>` Channel number.

<LogPt> Identifying number of the newly created balanced or single-ended logical port.  
Must be between 1 and the number of physical ports (see [INSTrument:TPORt:COUNT?](#)). If unspecified the numeric suffix is set to 1.

**Parameters:**

<PhysicalPort> Number of first/only physical port  
Range: 1 to number of physical ports

<PhysicalPort> Number of second physical port (optional), forming a balanced port with the first physical port.  
The port numbers must be different. Moreover, a physical port cannot be assigned to several logical ports.  
Range: 1 to number of physical ports

**Example:**

```
*RST; :SOUR:LPOR1 1,2
```

Combine the physical ports 1 and 2 to the logical port 1 (balanced)

```
SOUR:LPOR1?
```

Query the physical ports assigned to logical port no. 1. The response is 1, 2.

**Manual operation:** See ["Select Predefined Port"](#) on page 380

**SOURce<Ch>:LPORt<LogPt>:CLEAr [<Scope>]**

Dissolves balanced port <LogPt> or all logical ports.

**Suffix:**

<Ch> Channel number

<LogPt> Logical port number used to number balanced ports.  
Range according to the current port configuration ([SOURce<Ch>:LPORt<LogPt>](#)). If an undefined balanced port number is used, the analyzer generates an error message.  
Exception: Parameter ALL, see below.

**Setting parameters:**

<Scope> ALL  
If ALL is specified, all logical ports are dissolved; the <log\_port> suffix is ignored. If ALL is omitted, only the specified balanced port is dissolved.

**Example:** See [SOURce<Ch>:LPORt<LogPt>](#)

**Usage:** Setting only

**Manual operation:** See ["Select Predefined Port"](#) on page 380

**SOURce:GROUp...**

The [SOURce:GROUp...](#) commands define the group of (un-)used logical ports.

|                                                               |     |
|---------------------------------------------------------------|-----|
| <a href="#">SOURce&lt;Ch&gt;:GROup&lt;Grp&gt;</a> .....       | 909 |
| <a href="#">SOURce&lt;Ch&gt;:GROup&lt;Grp&gt;:CLEar</a> ..... | 909 |
| <a href="#">SOURce&lt;Ch&gt;:GROup&lt;Grp&gt;:PORTs</a> ..... | 910 |

---

### **SOURce<Ch>:GROup<Grp>** <arg0>, <arg1>

In "set direction" this command defines the set of active logical ports (the "master group") as the continuous range from <log\_port1> to <log\_port2>, i.e. logical ports outside this range are disabled.

In "get direction" it returns the minimum and maximum enabled logical port.

See [SOURce<Ch>:LPORt<LogPt>](#) on how to define logical ports.

#### **Suffix:**

|       |                                            |
|-------|--------------------------------------------|
| <Ch>  | Channel number.                            |
| <Grp> | Port group number, must be 1 (or omitted). |

#### **Parameters:**

|        |                                                                                                          |
|--------|----------------------------------------------------------------------------------------------------------|
| <arg0> |                                                                                                          |
| <arg1> | First and last logical port number in the port group. Must be omitted if the command is used as a query. |

**Example:** See [SOURce<Ch>:LPORt<LogPt>](#) on page 907

---

### **SOURce<Ch>:GROup<Grp>:CLEar** [<arg0>]

Dissolves the "master port group", i.e. reenables all logical ports.

#### **Suffix:**

|       |                                                                          |
|-------|--------------------------------------------------------------------------|
| <Ch>  | Channel number.                                                          |
| <Grp> | Port group number.<br>This suffix is ignored: only <Grp>=1 is supported. |

#### **Setting parameters:**

|        |                                                                                                                                                                                                                                                               |
|--------|---------------------------------------------------------------------------------------------------------------------------------------------------------------------------------------------------------------------------------------------------------------|
| <arg0> | ALL                                                                                                                                                                                                                                                           |
|        | If ALL is specified, all port groups are dissolved and a default port group 1, consisting of all available ports, is restored; the <Grp> suffix is ignored.                                                                                                   |
|        | If ALL is omitted, only the specified port group is dissolved, except the deleted port group was the only one, in which case again default port group 1 is restored. In case an undefined port group number is used, the analyzer generates an error message. |

**Example:** See [SOURce<Ch>:LPORt<LogPt>](#) on page 907

**Usage:** Setting only

**SOURce<Ch>:GROup<Grp>:PORTs** <arg0>[, <arg1>]...

Defines the set of active logical ports (the "master group") as an arbitrary selection of logical ports. The ports do not have to be numbered consecutively (as for port groups defined via `SOURce<Ch>:GROup<Grp>`).

See `SOURce<Ch>:LPORt<LogPt>` on how to define logical ports.

**Suffix:**

|       |                                            |
|-------|--------------------------------------------|
| <Ch>  | Channel number.                            |
| <Grp> | Port group number, must be 1 (or omitted). |

**Parameters:**

|        |                                                                          |
|--------|--------------------------------------------------------------------------|
| <arg0> |                                                                          |
| <arg1> | Logical port numbers. Must be omitted if the command is used as a query. |

**SOURce:POWer...**

The `SOURce:POWer...` commands define the power of the signal sources.

**Port-specific and general settings**

The `SOURce:POWer...` subsystem comprises port-specific and general settings. Port-specific settings are valid for the port specified by the numeric suffix <PhyPt> (`...:POWer<PhyPt>:...`). General settings are valid for all test ports of the analyzer; the port suffix is ignored. Refer to the description of the individual commands for more information.

|                                                                                        |     |
|----------------------------------------------------------------------------------------|-----|
| <code>SOURce&lt;Ch&gt;:POWer&lt;PhyPt&gt;[:LEVel][:IMMediate][:AMPLitude]</code> ..... | 910 |
| <code>SOURce:POWer:SWEpend:MODE</code> .....                                           | 911 |
| <code>SOURce:POWer:SWEpend:SDElay</code> .....                                         | 911 |

**SOURce<Ch>:POWer<PhyPt>[:LEVel][:IMMediate][:AMPLitude]** <IntSourcePow>

Defines the power of the internal signal source (channel base power).

**Suffix:**

|         |                                                                                                                                                          |
|---------|----------------------------------------------------------------------------------------------------------------------------------------------------------|
| <Ch>    | Channel number                                                                                                                                           |
| <PhyPt> | Test port number of the analyzer. This suffix is ignored because the selected channel base power applies to all source ports used in the active channel. |

**Parameters:**

|                |                                                                         |
|----------------|-------------------------------------------------------------------------|
| <IntSourcePow> | Internal source power                                                   |
| Range:         | The usable power range is frequency-dependent; refer to the data sheet. |
| *RST:          | -10 dBm                                                                 |
| Default unit:  | dBm                                                                     |

**Example:** `FUNC "XFR:POW:RAT B1, A2"`  
 Activate a frequency sweep and select the ratio B1/A2 as measured parameter for channel and trace no. 1.  
`SOUR:POW -6`  
 Set the internal source power for channel 1 to -6 dBm.

**Manual operation:** See ["Power"](#) on page 298

#### **SOURce:POWer:SWEepend:MODE** <SweepEndModes>

Selects the power mode at sweep end.

This is a global setting.

##### **Parameters:**

<SweepEndModes> AUTO | REDuce | KEEP

AUTO: at sweep end restore the power at sweep start  
 REDuce: at sweep end reduce the output power as if the channel base power was set to its minimum possible value  
 KEEP: at sweep end keep the power at its current level

**Example:** `SOURce:POWer:SWEepend:MODE REDuce`  
 Reduce power at sweep end.  
`SOURce:POWer:SWEepend:SDELay 0.01`  
 Use a settling delay of 10 ms  
`SOURce:POWer:SWEepend:MODE AUTO`  
 At sweep end, restore the power at sweep start

**Manual operation:** See ["Power Mode at Sweep End"](#) on page 147

#### **SOURce:POWer:SWEepend:SDELay** <SettlingDelay>

If sweep end mode REDuce or KEEP is active (see [SOURce:POWer:SWEepend:MODE](#)) this defines the settling delay at subsequent sweep starts, i.e. the time between power reset and sweep start when a new sweep is requested.

This is a global setting.

##### **Parameters:**

<SettlingDelay> Settling delay  
 Default unit: s

**Manual operation:** See ["Settling Delay / Reset Delay"](#) on page 147

### 11.5.2.15 STATus Commands

The `STATus:...` commands control the status reporting system. Status registers are not reset by `*RST`; use `*CLS` for this purpose.

|                                                              |     |
|--------------------------------------------------------------|-----|
| <a href="#">STATus:PRESet</a> .....                          | 912 |
| <a href="#">STATus:QUESTionable[:EVENT]?</a> .....           | 912 |
| <a href="#">STATus:QUESTionable:INTegrity[:EVENT]?</a> ..... | 912 |

|                                                                       |     |
|-----------------------------------------------------------------------|-----|
| <code>STATus:QUESTionable:INTegrity:HARDware[:EVENT]?</code> .....    | 912 |
| <code>STATus:QUESTionable:LIMit&lt;Lev&gt;[:EVENT]?</code> .....      | 912 |
| <code>STATus:QUESTionable:CONDition?</code> .....                     | 913 |
| <code>STATus:QUESTionable:INTegrity:CONDition?</code> .....           | 913 |
| <code>STATus:QUESTionable:INTegrity:HARDware:CONDition?</code> .....  | 913 |
| <code>STATus:QUESTionable:LIMit&lt;Lev&gt;:CONDition?</code> .....    | 913 |
| <code>STATus:QUESTionable:ENABLE</code> .....                         | 913 |
| <code>STATus:QUESTionable:INTegrity:ENABLE</code> .....               | 913 |
| <code>STATus:QUESTionable:INTegrity:HARDware:ENABLE</code> .....      | 913 |
| <code>STATus:QUESTionable:LIMit&lt;Lev&gt;:ENABLE</code> .....        | 913 |
| <code>STATus:QUESTionable:NTRansition</code> .....                    | 914 |
| <code>STATus:QUESTionable:INTegrity:NTRansition</code> .....          | 914 |
| <code>STATus:QUESTionable:INTegrity:HARDware:NTRansition</code> ..... | 914 |
| <code>STATus:QUESTionable:LIMit&lt;Lev&gt;:NTRansition</code> .....   | 914 |
| <code>STATus:QUESTionable:PTRansition</code> .....                    | 914 |
| <code>STATus:QUESTionable:INTegrity:PTRansition</code> .....          | 914 |
| <code>STATus:QUESTionable:INTegrity:HARDware:PTRansition</code> ..... | 914 |
| <code>STATus:QUESTionable:LIMit&lt;Lev&gt;:PTRansition</code> .....   | 914 |
| <code>STATus:QUEue[:NEXT]?</code> .....                               | 914 |

---

### **STATus:PRESet**

Configures the status reporting system such that device-dependent events are reported at a higher level.

The command affects only the transition filter registers, the `ENABLE` registers, and queue enabling:

- The `ENABLE` parts of the `STATus:OPERation` and `STATus:QUESTionable...` registers are set to all 1's.
- The `PTRansition` parts are set all 1's, the `NTRansition` parts are set to all 0's, so that only positive transitions in the `CONDition` part are recognized.

The status reporting system is also affected by other commands, see [Chapter 11.4.4.5, "Reset Values of the Status Reporting System"](#), on page 594.

**Example:**                    `STAT:PRES`  
Preset the status registers.

**Usage:**                    Event

---

### **STATus:QUESTionable[:EVENT]?**

### **STATus:QUESTionable:INTegrity[:EVENT]?**

### **STATus:QUESTionable:INTegrity:HARDware[:EVENT]?**

### **STATus:QUESTionable:LIMit<Lev>[:EVENT]?**

These commands return the contents of the `EVENT` parts of the `QUESTionable`, `QUESTionable:INTegrity`, `QUESTionable:INTegrity:HARDware`, and `QUESTionable:LIMit<Lev>` status registers. Reading an `EVENT` register clears it.



**Suffix:**  
 <Lev> Selects one of the two `QUESTIONable:LIMit` registers; see "[STATus:QUESTIONable:LIMit<1|2>](#)" on page 588.

**Example:** `STAT:QUES:LIM1?`  
 Query the `EVENT` part of the `QUESTIONable:LIMit1` register to check whether an event has occurred since the last reading.

**Usage:** Query only

**STATus:QUESTIONable:CONDition?**  
**STATus:QUESTIONable:INTEgrity:CONDition?**  
**STATus:QUESTIONable:INTEgrity:HARDware:CONDition?**  
**STATus:QUESTIONable:LIMit<Lev>:CONDition?**

Returns the contents of the `CONDition` part of the `QUESTIONable...` registers. Reading the `CONDition` registers is nondestructive.

**Suffix:**  
 <Lev> Selects one of the two `QUESTIONable:LIMit` registers; see "[STATus:QUESTIONable:LIMit<1|2>](#)" on page 588.

**Example:** `STAT:QUES:LIMit:COND?`  
 Query the `CONDition` part of the `QUESTIONable:LIMit1` register to retrieve the current status of the limit check.

**Usage:** Query only

**STATus:QUESTIONable:ENABLE <BitPattern>**  
**STATus:QUESTIONable:INTEgrity:ENABLE <BitPattern>**  
**STATus:QUESTIONable:INTEgrity:HARDware:ENABLE <BitPattern>**  
**STATus:QUESTIONable:LIMit<Lev>:ENABLE <BitPattern>**

Sets the enable mask which allows true conditions in the `EVENT` part of the `QUESTIONable...` registers to be reported in the summary bit. If a bit is 1 in the enable register and its associated event bit transitions to true, a positive transition will occur in the summary bit (e.g. bit 10 of the `QUESTIONable` register for the `LIMit1` register, bit 0 of the `LIMit1` register for the `LIMit2` register).

See also [Chapter 11.4.4.1, "Overview of Status Registers"](#), on page 582 and [Chapter 11.4.4.5, "Reset Values of the Status Reporting System"](#), on page 594.

**Suffix:**  
 <Lev> Selects one of the two `QUESTIONable:LIMit` registers; see "[STATus:QUESTIONable:LIMit<1|2>](#)" on page 588.

**Parameters:**  
 <BitPattern> Range: 0 to 65535 (decimal representation)  
 \*RST: n/a

**Example:** `STAT:QUES:LIM2:ENAB 6`  
 Set bits no. 1 and 2 of the `QUESTIONable:LIMit2:ENABLE` register

---

**STATus:QUESTionable:NTRansition** <BitPattern>

**STATus:QUESTionable:INTEgrity:NTRansition** <BitPattern>

**STATus:QUESTionable:INTEgrity:HARDware:NTRansition** <BitPattern>

**STATus:QUESTionable:LIMit<Lev>:NTRansition** <BitPattern>

Sets the negative transition filters of the `QUESTionable...` status registers. If a bit is set, a 1 to 0 transition in the corresponding bit of the associated condition register causes a 1 to be written in the associated bit of the corresponding event register.

**Suffix:**

<Lev> Selects one of the two `QUESTionable:LIMit` registers; see "[STATus:QUESTionable:LIMit<1|2>](#)" on page 588.

**Parameters:**

<BitPattern> Range: 0 to 65535 (decimal representation)  
\*RST: n/a

**Example:**

```
STAT:QUES:LIM2:NTR 6
Set bits no. 1 and 2 of the
QUESTionable:LIMit2:NTRansition register
```

---

**STATus:QUESTionable:PTRansition** <BitPattern>

**STATus:QUESTionable:INTEgrity:PTRansition** <BitPattern>

**STATus:QUESTionable:INTEgrity:HARDware:PTRansition** <BitPattern>

**STATus:QUESTionable:LIMit<Lev>:PTRansition** <BitPattern>

Configures the positive transition filters of the `QUESTionable...` status registers. If a bit is set, a 0 to 1 transition in the corresponding bit of the associated condition register causes a 1 to be written in the associated bit of the corresponding event register.

See also [Chapter 11.4.4.5, "Reset Values of the Status Reporting System"](#), on page 594.

**Suffix:**

<Lev> Selects one of the two `QUESTionable:LIMit` registers; see "[STATus:QUESTionable:LIMit<1|2>](#)" on page 588.

**Parameters:**

<BitPattern> Range: 0 to 65535 (decimal representation)  
\*RST: n/a

**Example:**

```
STAT:QUES:LIM2:PTR 6
Set bits no. 1 and 2 of the
QUESTionable:LIMit2:PTRansition register
```

---

**STATus:QUEue[:NEXT]?**

Queries and at the same time deletes the oldest entry in the error queue. Operation is identical to that of [SYSTem:ERRor\[:NEXT\]?](#).

The entry consists of an error number and a short description of the error. Positive error numbers are instrument-dependent. Negative error numbers are reserved by the SCPI standard; see section [Chapter 12.1, "Error Messages and Troubleshooting"](#), on page 1003.

**Example:**                   STAT:QUE?  
Query the oldest entry in the error queue. 0, "No error" is returned if the error queue is empty.

**Usage:**                    Query only

### 11.5.2.16 SYSTem Commands

The `SYSTem...` commands provide functions that are not related to instrument performance, such as functions for general housekeeping and functions related to global configurations.

#### SYSTem:COMMunicate...

The `SYSTem:COMMunicate...` commands provide remote control settings and configure remote (external) devices controlled by the R&S ZNL/ZNLE.

|                                                                           |     |
|---------------------------------------------------------------------------|-----|
| <code>SYSTem:COMMunicate:AKAL:CONNECTION</code> .....                     | 915 |
| <code>SYSTem:COMMunicate:AKAL:MMEMory[:STATe]</code> .....                | 916 |
| <code>SYSTem:COMMunicate:GPIB[:SELF]:DClear:SUPPress</code> .....         | 916 |
| <code>SYSTem:COMMunicate:GPIB[:SELF]:INIT:WAIT</code> .....               | 916 |
| <code>SYSTem:COMMunicate:GPIB[:SELF]:LPORt:ALIGn</code> .....             | 917 |
| <code>SYSTem:COMMunicate:NET:HOSTname</code> .....                        | 917 |
| <code>SYSTem:COMMunicate:RDEvice:AKAL:ADDRess</code> .....                | 917 |
| <code>SYSTem:COMMunicate:RDEvice:AKAL:ADDRess:ALL?</code> .....           | 918 |
| <code>SYSTem:COMMunicate:RDEvice:AKAL:CKIT:CATalog?</code> .....          | 918 |
| <code>SYSTem:COMMunicate:RDEvice:AKAL:CKIT:STANdard:CATalog?</code> ..... | 919 |
| <code>SYSTem:COMMunicate:RDEvice:AKAL:DATE?</code> .....                  | 920 |
| <code>SYSTem:COMMunicate:RDEvice:AKAL:FRANge?</code> .....                | 920 |
| <code>SYSTem:COMMunicate:RDEvice:AKAL:PORtS?</code> .....                 | 921 |
| <code>SYSTem:COMMunicate:RDEvice:AKAL:PREdUction[:STATe]</code> .....     | 921 |
| <code>SYSTem:COMMunicate:RDEvice:AKAL:SDATa?</code> .....                 | 921 |
| <code>SYSTem:COMMunicate:RDEvice:AKAL:WARMup[:STATe]?</code> .....        | 922 |

---

**SYSTem:COMMunicate:AKAL:CONNECTION** <CalStandard>, <Port>[,  
<SecondPort>[, <CalkitIndex>]]

Connects the selected calibration standard to one or two ports of the active calibration unit (see `SYSTem:COMMunicate:RDEvice:AKAL:ADDRess`).

**Setting parameters:**

<CalStandard>            THRough | OPEN | SHORt | MATCh

Connected one or two-port standard

<Port>                    Port number of the calibration unit, for one and two-port stand-  
ards.

<SecondPort> Second port number of the calibration unit.  
For two-port standards (THRough) this parameter must be provided, for one-port standards (OPEN | SHORt | MATCh) it must be omitted.

<CalkitIndex> For calibration units that are equipped with more than one calibration kit, this parameter indicates the 1-based index of the cal kit to be used (mandatory!).  
For other calibration units, this parameter is optional, but if it is provided, it must be set to 1.

**Example:** SYST:COMM:AKAL:CONN THR, 1, 2  
Connect a through standard between ports 1 and 2 of the cal unit.

**Usage:** Setting only

**Manual operation:** See "Apply/Cancel" on page 460

#### SYSTem:COMMunicate:AKAL:MMEMory[:STATe] <Boolean>

Shows or hides the memory of the active calibration unit (see [SYSTem:COMMunicate:RDEvice:AKAL:ADDRESS](#)).

##### Setting parameters:

<Boolean> ON - memory is shown in a separate drive.  
OFF - memory is not shown.  
\*RST: OFF

**Example:** SYST:COMM:AKAL:MMEM ON  
Show the memory of the active calibration unit.

**Usage:** Setting only

**Manual operation:** See "Apply/Cancel" on page 460

#### SYSTem:COMMunicate:GPIB[:SELF]:DCLear:SUPPpress <Boolean>

Suppresses/unsuppresses of Device Clear GPIB interface messages (DCL, SDC).

##### Parameters:

<Boolean>

#### SYSTem:COMMunicate:GPIB[:SELF]:INIT:WAIT <Boolean>

Determines/queries the execution behavior of INITiate[:IMMediate] commands (see [Chapter 11.5.2.7, "INITiate Commands"](#), on page 779).

If set to ON, an automatic \*WAI is added (see \*WAI on page 524), i.e. the commands execute synchronously.

##### Parameters:

<Boolean> \*RST: OFF

**Manual operation:** See "Remote Settings: Wait for Data after Sweep" on page 146

---

### **SYSTem:COMMunicate:GPIB[:SELF]:LPORt:ALIGn** <Boolean>

Configures/queries the logical port creation.

If set to ON, logical ports are aligned and must be set from low to high port, which was the only possibility prior to firmware V1.90. If set to OFF, new ports can be created freely, like in manual operation. See the example below.

**Parameters:**

<Boolean>                    \*RST:        ON

**Example:**

Starting with a 4-port analyzer's default logical port assignment  
L1<-->P1, L2<-->P2, L3<-->P3, L4<-->P4,  
the remote command  
SOUR:LPOR1 1, 2  
by default (ALIGn=ON) generates aligned logical ports  
L1<-->P1&P2, L2<-->P3, L3<-->P4.  
With ALIGn=OFF, the result is  
L1<-->P1&P2, L3<-->P3, L4<-->P4  
and L2 does not exist.

---

### **SYSTem:COMMunicate:NET:HOSTname** <HostName>

Sets or gets the host name of the instrument.

**Parameters:**

<HostName>                    Host name  
\*RST:                    A preset of the instrument doesn't change the host name.

---

### **SYSTem:COMMunicate:RDEvice:AKAL:ADDRess** <Address>

Selects one of the USB-connected calibration units for calibration (see commands SENSE<Ch>:CORRection:COLLect:AUTO...). This command is not necessary if only one cal unit is connected.

**Parameters:**

<Address>                    Name (USB address) of a connected calibration unit (string variable). The names of all connected cal units can be queried using [SYSTem:COMMunicate:RDEvice:AKAL:ADDRess:ALL?](#).

**Example:**

```
SYST:COMM:RDEV:AKAL:ADDR:ALL?
Query the names of all connected calibration units.
SYST:COMM:RDEV:AKAL:ADDR 'ZV-Z52::1234'
Select the cal unit named 'ZV-Z52::1234' for calibration.
CORR:COLL:AUTO '', 1, 2, 4
Perform an automatic 3-port TOSM calibration at test ports 1, 2,
and 4 using the calibration unit's default calibration kit file and
arbitrary test ports of the cal unit.
```

**Manual operation:** See "Cal Unit" on page 456

---

**SYSTem:COMMunicate:RDEvice:AKAL:ADDRess:ALL?**

Queries the names (USB addresses) of all connected calibration units.

**Example:** See `SYSTem:COMMunicate:RDEvice:AKAL:ADDRess`

**Usage:** Query only

**Manual operation:** See "Cal Unit" on page 456

---

**SYSTem:COMMunicate:RDEvice:AKAL:CKIT:CATalog?**

Queries all characterizations (cal kit files) which are stored on the connected calibration unit, either on the calibration unit's internal (flash) memory or on an SD card inserted at the calibration unit (prefix: "SD"). A possible response is 'Factory,ZN-Z51\_custom,Throughs,SD:test'. The factory characterization is always available; an empty string denotes that no calibration unit is connected.

If several cal units are USB-connected to the analyzer, the command queries the cal unit selected via `SYSTem:COMMunicate:RDEvice:AKAL:ADDRess`.

**Example:**

```
SYST:COMM:RDEV:AKAL:ADDR:ALL?
```

Query the names of all connected calibration units.

```
SYST:COMM:RDEV:AKAL:ADDR 'ZN-Z51::1234'
```

Select the cal unit named 'ZN-Z51::1234'.

```
SYSTem:COMMunicate:RDEvice:AKAL:CKIT:CATalog?
```

Query all characterizations stored on the connected calibration unit.

```
SYSTem:COMMunicate:RDEvice:AKAL:SDATa?
```

```
'My_calkit', OPEN, S11, 1
```

Query the characterization data for the characterization named 'My\_calkit' and an open standard (one-port, port restriction). A characterization with the queried properties must be available on the cal unit.

```
SYSTem:COMMunicate:RDEvice:AKAL:WARMup?
```

Query the warmup status of the calibration unit.

```
SYSTem:COMMunicate:RDEvice:AKAL:DATE? 'Factory'
```

Query the creation date of the factory calibration.

```
SYSTem:COMMunicate:RDEvice:AKAL:FRANge?
```

```
'Factory'
```

Query the frequency range of the factory calibration.

```
SYSTem:COMMunicate:RDEvice:AKAL:PORTs?
```

```
'Factory'
```

Query the port assignment of the factory calibration.

```
SYSTem:COMMunicate:RDEvice:AKAL:CKIT:STANdard:CATalog? 'Factory'
```

Query the standards of the factory calibration. Possible response:

```
'MOP (P1) , MSH (P1) , MMT (P1) , MOP (P2) , MSH (P2) ,
```

```
MMT (P2) ' – denotes an Open (m), Short (m) and Match (m)
```

standard at each of the ports 1 and 2.

**Usage:**

Query only

**Manual operation:** See "[Characterization](#)" on page 456

---

**SYSTem:COMMunicate:RDEvice:AKAL:CKIT:STANdard:CATalog? <CalKitName>**

Queries all calibration standards of a characterization (calkit file) that is stored on a connected calibration unit, either on the calibration unit's internal (flash) memory or on an SD card inserted at the calibration unit (if available). The query `SYSTem:COMMunicate:RDEvice:AKAL:CKIT:CATalog?` returns the names of the cal kit files. The factory characterization is always available.

**Query parameters:**

<CalKitName>

Name of the calkit file, string parameter.

'Factory' denotes the factory characterization, the prefix "SD:" indicates that the characterization is stored on an SD card inserted at the calibration unit.

**Example:**

See `SYSTem:COMMunicate:RDEvice:AKAL:CKIT:CATalog?`

**Usage:** Query only

**Manual operation:** See "[Characterization](#)" on page 456

---

**SYSTem:COMMunicate:RDEvice:AKAL:DATE?** <CalKitName>

Queries the creation date and time of the cal unit characterization (calkit file) <CalKitName>. A possible response is 'Friday, May 26, 2011, 10:13:40'. An empty string is returned if no calibration unit is connected.

If several cal units are USB-connected to the analyzer, the command queries the cal unit selected via [SYSTem:COMMunicate:RDEvice:AKAL:ADDRESS](#).

**Query parameters:**

**CalKitName** String parameter containing the name of a cal unit characterization (calkit file).  
'Factory' denotes the factory characterization; an empty string ' ' refers to the last referenced characterization; the prefix "SD:" indicates that the characterization is stored on an SD card inserted at the calibration unit.

**Example:** See [SYSTem:COMMunicate:RDEvice:AKAL:CKIT:CATalog?](#)

**Usage:** Query only

**Manual operation:** See "[Characterization](#)" on page 456

---

**SYSTem:COMMunicate:RDEvice:AKAL:FRANge?** <CalKitName>

Queries the frequency range of the cal unit characterization (calkit file) <CalKitName>. The response consists of the start and stop frequencies in Hz, separated by a comma. 0,0 is returned if no calibration unit is connected.

If several cal units are USB-connected to the analyzer, the command queries the cal unit selected via [SYSTem:COMMunicate:RDEvice:AKAL:ADDRESS](#).

**Query parameters:**

<CalKitName> String parameter containing the name of a cal unit characterization (calkit file).  
'Factory' denotes the factory characterization; an empty string ' ' denotes the last referenced characterization; the prefix "SD:" indicates that the characterization is stored on an SD card inserted at the calibration unit.

**Example:** See [SYSTem:COMMunicate:RDEvice:AKAL:CKIT:CATalog?](#)

**Usage:** Query only

**Manual operation:** See "[Characterization](#)" on page 456



**SYSTem:COMMunicate:RDEvice:AKAL:PORTs? <CalKitName>**

Queries the number of ports of a cal unit characterization (calkit file) <CalKitName>, the assigned connector types, and their gender. A possible response for a two-port calibration is '1,N 50 Ohm,MALE,2,N 50 Ohm,MALE'. An empty string is returned if no calibration unit is connected.

If several cal units are USB-connected to the analyzer, the command queries the cal unit selected via [SYSTem:COMMunicate:RDEvice:AKAL:ADDResS](#).

**Query parameters:**

<CalKitName> String parameter containing the name of a cal unit characterization (calkit file).  
'Factory' denotes the factory characterization; an empty string ' ' denotes the last referenced characterization; the prefix "SD:" indicates that the characterization is stored on an SD card inserted at the calibration unit.

**Example:** See [SYSTem:COMMunicate:RDEvice:AKAL:CKIT:CATalog?](#)

**Usage:** Query only

**Manual operation:** See "[Characterization](#)" on page 456

**SYSTem:COMMunicate:RDEvice:AKAL:PREduction[:STATe] <Boolean>**

Enables or disables automatic power reduction at all test ports while an automatic calibration is active.

**Parameters:**

<Boolean> Power reduction enabled or disabled.  
\*RST: ON

**Example:** [SYSTem:COMMunicate:RDEvice:AKAL:PREduction OFF](#)  
Disable automatic power reduction.

**Manual operation:** See "[Auto Power Setting for Cal Unit](#)" on page 142

**SYSTem:COMMunicate:RDEvice:AKAL:SDATa? <CalKitName>, <Type>, <SParameter>[, <FirstPort>, <SecondPort>]**

Reads the calibration data for a particular standard from a cal unit characterization (calkit file). If more than one calibration unit is connected, the related one must be selected using [SYSTem:COMMunicate:RDEvice:AKAL:ADDResS](#).

**Query parameters:**

<CalKitName> String parameter containing the name of a cal unit characterization (calkit file).  
'Factory' denotes the factory characterization; an empty string ' ' denotes the last referenced characterization; the prefix "SD:" indicates that the characterization is stored on an SD card inserted at the calibration unit.

|                          |                                                                                                                                                                                                                                                                                                                                                                                                                                                                                                                                                                                                                        |
|--------------------------|------------------------------------------------------------------------------------------------------------------------------------------------------------------------------------------------------------------------------------------------------------------------------------------------------------------------------------------------------------------------------------------------------------------------------------------------------------------------------------------------------------------------------------------------------------------------------------------------------------------------|
| <Type>                   | <p>THRough   OPEN   SHORt   MATCh   MMThrougH   MFThrougH   FFThrougH   MOPen   FOPen   MSHort   FSHort   MMTCh   FMTCh</p> <p>Standard types; for a description refer to table <a href="#">Standard types and their parameters</a>. The standard types of a particular characterization can be queried via <code>SYSTem:COMMunicate:RDEvice:AKAL:CKIT:STANdard:CATalog?</code>.</p> <p>The factory characterization usually does not contain data for a through standard; therefore a query of the type <code>SYSTem:COMMunicate:RDEvice:AKAL:SDATa?'Factory', THR, S11, 1, 2</code> results in an error message.</p> |
| <SParameter>             | <p>S11   S12   S21   S22</p> <p>S-parameter of the standard, use <code>S11</code> for one-port standards, one of the four for 2-port standards.</p>                                                                                                                                                                                                                                                                                                                                                                                                                                                                    |
| <FirstPort>              | <p>First port number (sufficient for one-port standards). Port numbers can be omitted if the cal kit data is valid for all ports; see <code>MMEMory:LOAD:CKIT:SDATa</code>.</p>                                                                                                                                                                                                                                                                                                                                                                                                                                        |
| <SecondPort>             | <p>Second port number, for two-port standards. Port numbers can be omitted if the cal kit data is valid for all ports.</p>                                                                                                                                                                                                                                                                                                                                                                                                                                                                                             |
| <b>Example:</b>          | <p>See <code>SYSTem:COMMunicate:RDEvice:AKAL:CKIT:CATalog?</code></p>                                                                                                                                                                                                                                                                                                                                                                                                                                                                                                                                                  |
| <b>Usage:</b>            | <p>Query only</p>                                                                                                                                                                                                                                                                                                                                                                                                                                                                                                                                                                                                      |
| <b>Manual operation:</b> | <p>See "<a href="#">Characterization</a>" on page 456</p>                                                                                                                                                                                                                                                                                                                                                                                                                                                                                                                                                              |

---

#### **SYSTem:COMMunicate:RDEvice:AKAL:WARMup[:STATe]?**

Queries the warmup state of the connected calibration unit R&S ZV\_Z5x. If several cal units are USB-connected to the analyzer, the command queries the cal unit selected via `SYSTem:COMMunicate:RDEvice:AKAL:ADDRes`.

Possible responses are 1 (true, if the calibration unit has been connected for a sufficient time to reach its operating temperature) or 0 (false). 0 is also returned if no calibration unit is connected.

**Example:** See `SYSTem:COMMunicate:RDEvice:AKAL:CKIT:CATalog?`

**Usage:** Query only

**Manual operation:** See "[Characterization](#)" on page 456

#### **SYSTem:DATA:MEMory...**

These commands allow you to configure memory-mapped trace data transfer. See [Chapter 9.4.3, "Memory-Mapped Trace Data Transfer"](#), on page 247.

---

**SYSTem:DATA:MEMory:ADD** <TraceName>, <DataFormat>, <NumberOfPoints>

Adds trace <TraceName> to a previously initialized shared memory buffer.

Traces can only be added after the `SYSTem:DATA:MEMory:INITalize` and before the corresponding `SYSTem:DATA:MEMory:COMMit`.

For background information, see [Chapter 9.4.3, "Memory-Mapped Trace Data Transfer"](#), on page 247.

**Setting parameters:**

<TraceName> Trace name. Identifies the trace within the active channel setup.

<DataFormat> SDATa | FDATa  
The data format of the stored trace values.

**SDATa**

Unformatted (complex) trace data.

**FDATa**

Formatted (real-valued) trace data.

<NumberOfPoints> Number of trace values to be stored.

**Usage:** Setting only

---

**SYSTem:DATA:MEMory:CATalog?**

Queries the names of the shared memory buffers initialized using `SYSTem:DATA:MEMory:INITalize`.

Before the `SYSTem:DATA:MEMory:COMMit`, an initialized shared memory buffer has the temporary name `NewMemory`.

For background information, see [Chapter 9.4.3, "Memory-Mapped Trace Data Transfer"](#), on page 247.

**Usage:** Query only

---

**SYSTem:DATA:MEMory:COMMit** <ShMemName>

Completes the setup of a named shared memory buffer that was initialized using `SYSTem:DATA:MEMory:INITalize` and configured using one or more `SYSTem:DATA:MEMory:ADD`. The buffer is then available in Windows.

Before the next `COMMit`, the size of the created buffer can be queried using `SYSTem:DATA:MEMory:SIZE?`.

To delete the buffer and free its memory, use `SYSTem:DATA:MEMory:DElete` <ShMemName>, or `SYSTem:DATA:MEMory:RESet`.

For background information, see [Chapter 9.4.3, "Memory-Mapped Trace Data Transfer"](#), on page 247.

**Setting parameters:**

<ShMemName> Gives the shared memory buffer a name, which is required by processes that want to access it. The name must be unique within the running Windows instance. The names of the shared memory buffers initialized using `SYSTem:DATA:MEMory:INITalize` can be queried using `SYSTem:DATA:MEMory:CATalog?`.

**Usage:** Setting only

**SYSTem:DATA:MEMory:DELeTe** <ShMemName>

Deletes a shared memory buffer <ShMemName> initialized using `SYSTem:DATA:MEMory:INITalize`.

Before the `SYSTem:DATA:MEMory:COMMit`, an initialized shared memory buffer has the temporary name `NewMemory`. Do not delete it.

**Setting parameters:**

<ShMemName> Unique name of the shared memory buffer.

**Usage:** Setting only

**SYSTem:DATA:MEMory:INITalize**

Initializes a new shared memory buffer.

- Use `SYSTem:DATA:MEMory:ADD` to add traces to it.
- Finally, use `SYSTem:DATA:MEMory:COMMit` to complete the setup and create the named shared memory buffer in Windows.

For background information, see [Chapter 9.4.3, "Memory-Mapped Trace Data Transfer"](#), on page 247.

**Usage:** Event

**SYSTem:DATA:MEMory:OFFSet?**

Queries the offset in bytes of the last added trace data block, relative to the start of the shared memory buffer (see `SYSTem:DATA:MEMory:ADD`).

The offset is required by processes that want to read the trace data from the buffer.

For background information, see [Chapter 9.4.3, "Memory-Mapped Trace Data Transfer"](#), on page 247.

**Usage:** Query only

**SYSTem:DATA:MEMory:RESet**

Deletes all shared memory buffers initialized using `SYSTem:DATA:MEMory:INITalize`.

For background information, see [Chapter 9.4.3, "Memory-Mapped Trace Data Transfer"](#), on page 247.

**Usage:** Event

### SYSTem:DATA:MEMory:SIZE?

Queries the size of the shared memory buffer that was last created using [SYSTem:DATA:MEMory:COMMit](#).

For background information, see [Chapter 9.4.3, "Memory-Mapped Trace Data Transfer"](#), on page 247.

**Usage:** Query only

### SYSTem... (Contd.)

The following [SYSTem...](#) commands provide general instrument configurations.

|                                                   |     |
|---------------------------------------------------|-----|
| <a href="#">SYSTem:DATE</a> .....                 | 925 |
| <a href="#">SYSTem:DISPlay:CONDuctances</a> ..... | 925 |
| <a href="#">SYSTem:FREQuency?</a> .....           | 926 |
| <a href="#">SYSTem:PRESet:USER:CAL</a> .....      | 926 |
| <a href="#">SYSTem:SETTings:UPDate</a> .....      | 926 |
| <a href="#">SYSTem:TIME</a> .....                 | 927 |

### SYSTem:DATE <Year>, <Month>, <Day>

The command queries or defines the instrument's current date setting.

#### Parameters:

|         |                                                                |
|---------|----------------------------------------------------------------|
| <Year>  | Year, four-digit number                                        |
| <Month> | Month, two-digit number, 01 (for January) to 12 (for December) |
| <Day>   | Day, two-digit number, 01 to the number of days in the month   |

#### Example:

`SYST:DATE?`  
Response: 2012,05,01 - it is the 1st of May, 2012.

### SYSTem:DISPlay:CONDuctances <Boolean>

Changes the presentation of "capacitance C<i>" in parallel with resistance R<i>" circuit blocks in lumped de/embedding networks.

#### Parameters:

|           |                                                         |
|-----------|---------------------------------------------------------|
| <Boolean> | ON - display conductances<br>OFF - display capacitances |
|-----------|---------------------------------------------------------|

**Manual operation:** See ["Conductance in Embedding Networks"](#) on page 144

**SYSTem:FREQuency? <MinMax>**

Queries the minimum and maximum frequency of the network analyzer. For an overview refer to the tables at the beginning of "[SENSe:]FREQuency..." on page 875.

**Tip:** In contrast to [SENSe<Ch>:]FREQuency:START? and the other sweep range commands, SYSTem:FREQuency? can be used in all sweep modes.

**Query parameters:**

<MinMax>            MINimum | MAXimum

**Return values:**

<Frequency>        MINimum | MAXimum  
Return minimum or maximum frequency.

**Example:**            See [SENSe<Ch>:]FREQuency:CENTer

**Usage:**              Query only

**Manual operation:** See "Start Frequency / Stop Frequency / Center Frequency / Span Frequency" on page 296

**SYSTem:PRESet:USER:CAL <PresetUserCal>**

Selects a calibration from the calibration pool that shall be restored during a user-defined preset.

The corresponding cal group file (<PresetUserCal>.cal) must be available in the cal pool directory

C:\Users\Public\Documents\Rohde-Schwarz\ZNL\Calibration\Data\.

**Parameters:**

<PresetUserCal>    Name of the cal group (i.e. the name of the cal group file without path and extension).  
Use the empty string to restore the default behavior (no preset user cal).

**Example:**            MMEMORY:STORE:CORRection 1, 'Ref11  
Trans123.cal'  
Adds the active user calibration to the memory pool  
SYSTem:PRESet:USER:CAL 'Ref11 Trans123'  
Sets the newly created cal pool member as the preset user cal.  
SYSTem:PRESet:USER:CAL?  
Queries for the preset user cal. Returns 'Ref11 Trans123'  
SYSTem:PRESet:USER:CAL ''  
Restores the default behaviour of the instrument: no preset user cal.

**Manual operation:** See "Preset User Cal" on page 482

**SYSTem:SETTings:UPDate <Activate>**

Initiates an immediate update of the channel or trace settings.

The command has an effect if the analyzer operates in single sweep mode (`INITiate<Ch>:CONTinuous OFF`). In this scenario, a change of the channel or trace settings is usually not taken into account immediately. The analyzer waits until the end of the current sweep sequence and changes all settings made during the last sweep period when the next single sweep sequence is initiated. Several settings can be made en bloc, which generally saves time.

`SYSTem:SETTings:UPDate ONCE` causes the analyzer to apply the settings at once without waiting for the end of the current single sweep sequence. The command has no effect in continuous sweep mode or if the display update is switched on.

The settings are also updated when the continuous sweep mode is activated (`INITiate<Ch>:CONTinuous ON`).

#### Setting parameters:

<Activate>                    ONCE  
                                      Causes an immediate update of the settings.

**Example:**                    `INIT:CONT OFF`  
                                      Activate single sweep mode.  
                                      `SYST:SETT:UPD ONCE`  
                                      Update the settings made during the current single sweep period.

**Usage:**                        Setting only

**SYSTem:TIME** <Hours>, <Minutes>, <Seconds>

The command queries or defines the instrument's current time setting.

#### Parameters:

<Hours>                        Range:     0...23  
 <Minutes>                     Range:     0...59  
 <Seconds>                     Range:     0...59

**Example:**                    `SYST:TIME?`  
                                      Response: 12, 0, 0 - it is precisely 12 pm.

### 11.5.2.17 TRACe Commands

The `TRACe . . .` commands handle active trace data and trace data stored in the analyzer's internal memory.



#### Trace data formats

Trace data is transferred in either ASCII or block data (REAL) format, depending on the `FORMat[:DATA]` setting. If the block data format is used, it is recommended to select EOI as receive terminator (`SYSTem:COMMunicate:GPIB[:SELF]:RTERminator EOI`).

The commands in the TRACe... menu use the following ZVR-compatible parameters to specify traces:

**Table 11-20: Reserved Trace Names**

| Parameter                                                                    | Meaning                                                                                                                         | Used in                                                                                                                                   |
|------------------------------------------------------------------------------|---------------------------------------------------------------------------------------------------------------------------------|-------------------------------------------------------------------------------------------------------------------------------------------|
| CH1DATA<br>CH2DATA<br>CH3DATA<br>CH4DATA                                     | Active data trace of channels 1 to 4                                                                                            | TRACe:COPIY<br>TRACe[:DATA]:STIMulus[:ALL]?<br>TRACe[:DATA][:RESPonse][:ALL]?<br>CALCulate<Chn>:MATH[:EXPRession][:DEFine]                |
| CH1MEM<br>CH2MEM<br>CH3MEM<br>CH4MEM                                         | Active memory trace associated to the active data trace CH1DATA, CH2DATA, CH3DATA, CH4DATA, respectively.                       | TRACe[:DATA]:STIMulus[:ALL]?<br>TRACe[:DATA][:RESPonse][:ALL]?                                                                            |
| IMPLied                                                                      | Active data trace, addressed with <Chn>                                                                                         | CALCulate<Chn>:MATH[:EXPRession][:DEFine]                                                                                                 |
| CHMem                                                                        | Active memory trace assigned to the IMPLied trace                                                                               | CALCulate<Chn>:MATH[:EXPRession][:DEFine]                                                                                                 |
| MDATA1<br>MDATA2<br>MDATA3<br>MDATA4<br>MDATA5<br>MDATA6<br>MDATA7<br>MDATA8 | Memory trace named Mem<n> [Trc<m>]. The trace name is unique because <n> counts all data and memory traces in the active setup. | TRACe:CLEAr<br>TRACe:COPIY<br>TRACe[:DATA]:STIMulus[:ALL]?<br>TRACe[:DATA][:RESPonse][:ALL]?<br>CALCulate<Chn>:MATH[:EXPRession][:DEFine] |

### TRACe:COPIY <MemTraceName>, <DataTraceName>

Copies a data trace to a memory trace. The trace to be copied can be specified by two alternative methods:

- As the active data trace of channels 1 to 4 (CH1DATA, CH2DATA, CH3DATA, CH4DATA). If a mathematical trace is active, the associated data trace is copied.
- As a trace with a name (string variable).

The created memory trace can be specified as follows:

- As the memory trace named Mem<n> [Trc<m>], where n = 1, ... 8 and Trc<m> is the name of the copied data trace (MDATA1, MDATA2, MDATA3, MDATA4, MDATA5, MDATA6, MDATA7, MDATA8).
- As a memory trace with an arbitrary name (string variable).

An existing memory trace with the same name is overwritten.



**Note:** The copied trace is the data trace which is not modified by any mathematical operations. To copy a mathematical trace to a memory trace, use `TRACe:COPI:MATH`. To copy the active trace to the memory using an automatic memory trace name, use `CALCulate<Chn>:MATH:MEMorize`.

**Setting parameters:**

<MemTraceName> Name of the memory trace (see also [Table 11-20](#)).

Range: <memory\_trace> is either a string variable (enclosed in single or double quotes) or one of the following reserved names (no string variables): MDATA1 | MDATA2 | MDATA3 | MDATA4 | MDATA5 | MDATA6 | MDATA7 | MDATA8 (only for memory traces Mem<n>[Trc<m>], where n = 1, ... 8).

<DataTraceName> Name of the data trace (see also [Table 11-20](#)).

Range: <data\_trace> is either a string variable (enclosed in single or double quotes) or one of the following reserved names (no string variables): CH1DATA | CH2DATA | CH3DATA | CH4DATA (only for the active data trace in channels Ch1, Ch2, Ch3, Ch4).

**Example:**

```
*RST; :SWE:POIN 20
```

Create a trace with 20 sweep points, making the created trace the active trace of channel 1 (omitted optional mnemonic SENSE1).

```
TRAC:COPI "Mem_Pt20", CH1DATA
```

Copy the current state of the created trace to a memory trace named "Mem\_Pt20". The memory trace is not displayed.

```
DISP:WIND:TRAC2:FEED "MEM_PT20"
```

Display the created memory trace in the active diagram area (diagram area no. 1).

**Usage:** Setting only

**Manual operation:** See "[Data to <Destination>](#)" on page 336

---

**TRACe:COPI:MATH** <MemTraceName>, <DataTraceName>

Copies a mathematical trace to a memory trace. The trace to be copied can be specified by two alternative methods:

- As the active mathematical trace of channels 1 to 4 (CH1DATA, CH2DATA, CH3DATA, CH4DATA)
- As a trace with a name (string variable).

The created memory trace can be specified as follows:

- As the memory trace named Mem<n>[Trc<m>], where n = 1, ... 8 and Trc<m> is the name of the copied data trace (MDATA1, MDATA2, MDATA3, MDATA4, MDATA5, MDATA6, MDATA7, MDATA8).
- As a memory trace with an arbitrary name (string variable).

An existing memory trace with the same name is overwritten.

**Note:** To copy a data trace which is not modified by any mathematical operations, use `TRACe:COPI`

**Setting parameters:**

|                                    |                                                                                                                                                                                                                                                                                                                                                                                                                                                                                                                                  |
|------------------------------------|----------------------------------------------------------------------------------------------------------------------------------------------------------------------------------------------------------------------------------------------------------------------------------------------------------------------------------------------------------------------------------------------------------------------------------------------------------------------------------------------------------------------------------|
| <code>&lt;MemTraceName&gt;</code>  | Name of the memory trace (see also <a href="#">Table 11-20</a> ).<br>Range: <code>&lt;memory_trace&gt;</code> is either a string variable (enclosed in single or double quotes) or one of the following reserved names (no string variables): <code>MDATA1</code>   <code>MDATA2</code>   <code>MDATA3</code>   <code>MDATA4</code>   <code>MDATA5</code>   <code>MDATA6</code>   <code>MDATA7</code>   <code>MDATA8</code> (only for memory traces <code>Mem&lt;n&gt;[Trc&lt;m&gt;]</code> , where <code>n = 1, ... 8</code> ). |
| <code>&lt;DataTraceName&gt;</code> | Name of the data trace (see also <a href="#">Table 11-20</a> ).<br>Range: <code>&lt;data_trace&gt;</code> is either a string variable (enclosed in single or double quotes) or one of the following reserved names (no string variables): <code>CH1DATA</code>   <code>CH2DATA</code>   <code>CH3DATA</code>   <code>CH4DATA</code> (only for the active data trace in channels <code>Ch1, Ch2, Ch3, Ch4</code> ).                                                                                                               |

**Example:**

```
*RST; :SWE:POIN 20
Create a trace with 20 sweep points, making the created trace
the active trace of channel 1 (omitted optional mnemonic
SENSe1).
CALC:MATH:SDEF 'Trc1 / 2'; :CALC:MATH:STAT ON
Define a mathematical trace, dividing the data trace by 2. Acti-
vate the mathematical mode and display the mathematical trace
instead of the data trace.
TRAC:COPI:MATH 'Mem_Pt20',CH1DATA; :CALC:MATH:
STAT OFF
Copy the current state of the mathematical trace to a memory
trace named "Mem_Pt20". The memory trace is not displayed.
Switch the display back to the data trace.
DISP:WIND:TRAC2:FEED 'MEM_PT20'
Display the created memory trace together with the data trace.
```

**Usage:** Setting only

### 11.5.2.18 TRIGger Commands

#### TRIGger[:SEquence]...

The `TRIGger[:SEquence]...` commands synchronize the analyzer's measurement sequences to external events. These events are indicated to the VNA by sending trigger signals via Trigger In or the Aux. Port (R&S ZNL with option R&S FPL1-B5 only).

|                                                                  |     |
|------------------------------------------------------------------|-----|
| <code>TRIGger&lt;Ch&gt;[:SEquence]:HOLDoff</code> .....          | 931 |
| <code>TRIGger&lt;Ch&gt;[:SEquence]:LINK</code> .....             | 931 |
| <code>TRIGger&lt;Ch&gt;[:SEquence]:MULTiple:HOLDoff</code> ..... | 932 |

|                                                 |     |
|-------------------------------------------------|-----|
| TRIGger<Ch>[:SEQuence]:MULTiple:SLOPe<Num>..... | 932 |
| TRIGger<Ch>[:SEQuence]:MULTiple:SOURce.....     | 933 |
| TRIGger<Ch>[:SEQuence]:SLOPe.....               | 934 |
| TRIGger<Ch>[:SEQuence]:SOURce.....              | 934 |

---

### TRIGger<Ch>[:SEQuence]:HOLDoff <DelayTime>

Sets a delay time between the trigger event and the start of the measurement ("Trigger Delay").

**Suffix:**

<Ch> Channel number.

**Parameters:**

<DelayTime> Delay time.  
 Range: 0 s to 13680 s  
 Increment: 10 ms  
 \*RST: 0 s  
 Default unit: s

**Example:**

```
TRIG:SOUR MAN
Activate external trigger source.
TRIG:HOLD UP
Set a delay time of 10 ms.
```

**Manual operation:** See "Delay" on page 325

---

### TRIGger<Ch>[:SEQuence]:LINK <MeasSequence>

Selects the triggered measurement sequence. The identifier for the sequence is a string variable.

**Suffix:**

<Ch> Channel number

**Parameters:**

<MeasSequence> Triggered measurement sequence, string variable.  
 'SWEep' – trigger event starts an entire sweep.  
 'SEGment' – trigger event starts a sweep segment, if segmented frequency sweep is active (see example below). If another sweep type is active, the trigger event starts an entire sweep.  
 'POINT' – trigger event starts measurement at the next sweep point.  
 'PPOINT' – trigger event starts the next partial measurement at the current or at the next sweep point.  
 \*RST: 'SWEep'

**Example:**           SEGM:ADD; :SWE:TYPE SEGM  
                           Select segmented frequency sweep.  
                           TRIG:LINK 'SEGM'  
                           Select a trigger segment as triggered measurement sequence.  
                           TRIG:LINK?  
                           Query the triggered measurement sequence. The response is  
                           'SEGMENT'.

**Manual operation:** See "[Sequence](#)" on page 324

**TRIGger<Ch>[:SEQuence]:MULTiple:HOLDoff <MeasSequence>[, <DelayTime>]**

Sets a delay time between the trigger event and the start of the measurement ("Trigger Delay") in multiple trigger mode.

**Suffix:**

<Ch>                    Channel number

**Parameters:**

<MeasSequence>       SWEep | SEGment | POINT | PPOINT  
                           Triggered measurement sequence, PPOINT denotes "partial measurement"; see [TRIGger<Ch>\[:SEQuence\]:LINK](#).

<DelayTime>            Delay time  
                           Range:        0 s to 13680 s  
                           Increment:  10 ms  
                           \*RST:        0 s  
                           Default unit: s

**Example:**            See [TRIGger<Ch>\[:SEQuence\]:MULTiple:SOURce](#)

**Manual operation:** See "[.../Source/...](#)" on page 326

**TRIGger<Ch>[:SEQuence]:MULTiple:SLOPe<Num> <MeasSequence>[, <Slope>]**

Qualifies whether the multiple trigger events occur on the rising or on the falling edge or on the beginning of the high / low level periods of the external TTL trigger signal <Num>.

**Suffix:**

<Ch>                    Channel number  
                           <Num>                Number of trigger signal (1 or 2)

**Parameters:**

<MeasSequence>       SWEep | SEGment | POINT | PPOINT  
                           Triggered measurement sequence, PPOINT denotes "partial measurement"; see [TRIGger<Ch>\[:SEQuence\]:LINK](#).

<Slope>                POSitive | NEGative | HIGH | LOW  
                           Trigger slope for the triggered measurement sequence:  
                           POSitive | NEGative - rising or falling edge  
                           HIGH | LOW - high or low level

**Example:** See [TRIGger<Ch>\[:SEQuence\]:MULTiple:SOURce](#)

**Manual operation:** See "[.../Source/...](#)" on page 326

---

**TRIGger<Ch>[:SEQuence]:MULTiple:SOURce** <Sequence>[, <TrigSource>]

Selects the source of the trigger events the analyzer uses to start a measurement sequence in multiple trigger mode ([TRIGger<Ch>\[:SEQuence\]:SOURce MULTiple](#)).

**Suffix:**

<Ch> Channel number

**Parameters:**

<Sequence> SWEep | SEGment | POINT | PPOINT  
 Triggered measurement sequence  
 PPOINT denotes "partial measurement"; see [TRIGger<Ch>\[:SEQuence\]:LINK](#).

<TrigSource> IMMEDIATE | EXT1 | EXT2 | E1A2 | E1O2 | MANUAL  
 Trigger source for the triggered measurement sequence

**IMMEDIATE**

Free run measurement (untriggered)

**EXT1**

Trigger event at Trigger In or Pin 2 of [Aux. Port](#)  
 The latter requires option R&S FPL1-B5 (R&S ZNL only).

**EXT2**

Trigger event at pin 25 of [Aux. Port](#).  
 Requires option R&S FPL1-B5 (R&S ZNL only).

**E1A2**

Trigger events at EXT1 **AND** EXT2

**E1O2**

Trigger event at EXT1 **OR** EXT2

**MANUAL**

Trigger event generated by pressing the "Manual Trigger" soft-key

**Example:**

TRIG:MULT:SOUR SWE, EXT1; SOUR POIN, EXT2  
 Select external trigger 1 as a trigger source for the entire sweep,  
 external trigger 2 as a trigger source for each point.

TRIG:MULT:SLOP1 SWE, POS; SLOP2 POIN, POS

Trigger on the rising edges of the external trigger signals 1 and 2.

TRIG:MULT:HOLD POIN, 1ms

Define a trigger delay of 1 ms before each sweep point.

**Manual operation:** See "[.../Source/...](#)" on page 326

---

**TRIGger<Ch>[:SEQuence]:SLOPe <Slope>**

Qualifies whether the trigger event occurs on the rising or on the falling edge or on the beginning of the high / low level periods of the external TTL trigger signal.

**Suffix:**

<Ch> Channel number

**Parameters:**

<Slope> POSitive | NEGative | HIGH | LOW  
 Trigger slope for the triggered measurement sequence:  
 POSitive | NEGative - rising or falling edge  
 HIGH | LOW - high or low level

**Example:**

TRIG:SOUR EXT  
 Activate external signal as trigger source.  
 TRIG:SLOP NEG  
 Trigger on the negative edge of the (external TTL) trigger signal.

**Manual operation:** See "[Signal Type](#)" on page 325

---

**TRIGger<Ch>[:SEQuence]:SOURce <TrigSource>**

Selects the source of the trigger events that the analyzer uses to start a measurement sequence.

**Suffix:**

<Ch> Channel number

**Parameters:**

<TrigSource> IMMEDIATE | EXTERNAL | MANUAL | MULTIPLE  
**IMMEDIATE**  
 Free run measurement (untriggered)  
**EXTERNAL**  
 EXTERNAL – trigger by external signal applied to the Trigger In connector or pin 2 of the Aux. Port (R&S ZNL with option -B5 only).  
**MANUAL**  
 Trigger event generated by pressing the "Manual Trigger" soft-key  
**MULTIPLE**  
 Multiple trigger mode, configured by  
 TRIGger<Ch>[:SEQuence]:MULTiple... commands

**Example:**

TRIG:SOUR MAN  
 Activate manual trigger mode. The analyzer starts the next measurement sequence when the "Manual Trigger" button is pressed.

**Manual operation:** See "[FreeRun / External / Manual / Multiple Triggers](#)" on page 323

### 11.5.3 R&S ZVR/ZVABT Compatible Commands

The commands in this chapter are supported for compatibility with analyzers of the R&S ZVR and R&S ZVAB family; they do not introduce any new functionality. For new programs, it is recommended to use the commands in [Chapter 11.5.2, "SCPI Command Reference"](#), on page 597.

|                                                            |     |
|------------------------------------------------------------|-----|
| CALCulate<Chn>:LIMit:CONTRol:DOMain.....                   | 936 |
| CALCulate<Chn>:LIMit:RDOMain:COMPLex.....                  | 936 |
| CALCulate<Chn>:LIMit:RDOMain:FORMat.....                   | 937 |
| CALCulate<Chn>:LIMit:RDOMain:SPACing.....                  | 937 |
| CALCulate<Chn>:LIMit:LOWer:STATe.....                      | 938 |
| CALCulate<Chn>:LIMit:UPPer:STATe.....                      | 938 |
| CALCulate<Ch>:PARAmeter:DEFine.....                        | 938 |
| CALCulate<Chn>:MARKer<Mk>:FUNCTion:BWIDTh.....             | 939 |
| CALCulate<Chn>:MARKer<Mk>:FUNCTion:DELTA:STATe.....        | 940 |
| CALCulate<Chn>:MARKer<Mk>:FUNCTion:TARGeT.....             | 940 |
| CALCulate<Chn>:MARKer<Mk>:FUNCTion[:SELect].....           | 941 |
| CALCulate<Chn>:MARKer<Mk>:MAXimum.....                     | 941 |
| CALCulate<Chn>:MARKer<Mk>:MINimum.....                     | 941 |
| CALCulate<Chn>:MARKer<Mk>:SEARch:LEFT.....                 | 942 |
| CALCulate<Chn>:MARKer<Mk>:SEARch:NEXT.....                 | 942 |
| CALCulate<Chn>:MARKer<Mk>:SEARch:RIGHT.....                | 942 |
| CALCulate<Chn>:MARKer<Mk>:SEARch[:IMMEdiate].....          | 942 |
| CALCulate<Chn>:MATH[:EXPReSSion][:DEFine].....             | 942 |
| DIAGnostic:SERVice:FUNCTion.....                           | 943 |
| FORMat:DEXPort:SOURce.....                                 | 943 |
| INPut<PhyPt>:ATTenuation.....                              | 944 |
| INSTRument[:SELect].....                                   | 944 |
| OUTPut<Chn>:DPORt.....                                     | 945 |
| [SENSe<Ch>:]CORRection:CKIT:<ConnType>:<StandardType>..... | 945 |
| [SENSe:]CORRection:CKIT:INSTall.....                       | 946 |
| [SENSe<Ch>:]CORRection:COLLect[:ACQuire].....              | 947 |
| [SENSe<Ch>:]CORRection:COLLect:METHod.....                 | 948 |
| [SENSe<Ch>:]CORRection:COLLect:SAVE:DEFault.....           | 948 |
| [SENSe<Ch>:]CORRection:COLLect:SAVE[:DUMMy].....           | 949 |
| [SENSe<Ch>:]CORRection:DATA.....                           | 950 |
| [SENSe<Ch>:]CORRection:OFFSet<PhyPt>:MAGNitude.....        | 952 |
| [SENSe<Ch>:]FREQuency:MODE.....                            | 953 |
| [SENSe<Ch>:]SEGMENT<Seg>:CLEar.....                        | 953 |
| [SENSe<Ch>:]SEGMENT<Seg>:OVERlap.....                      | 953 |
| [SENSe<Ch>:]SWEep:SPACing.....                             | 954 |
| [SENSe<Chn>:]FUNCTion[:ON].....                            | 954 |
| TRACe:CLEar.....                                           | 955 |
| TRACe[:DATA][:RESPonse][:ALL]?                             | 956 |
| TRACe[:DATA]:STIMulus[:ALL]?                               | 957 |

**CALCulate<Chn>:LIMit:CONTRol:DOMain <SweepType>**

Deletes the existing limit line and (re-)defines the physical units of the stimulus values of the limit line. The units of the response values and the scaling of the y-axis can be defined via `CALCulate<Ch>:LIMit:RDOMain:...`

**Suffix:**

<Chn> Channel number used to identify the active trace.

**Setting parameters:**

<SweepType> FLIN | FLOG | FSEG | FSINGle | TLIN | TLOG | PLIN | PLOG | PSINGle

Keywords for the units of the stimulus values. The selected unit must be compatible with the sweep type (`[SENSe<Ch>: ]SWEep:TYPE`); otherwise the limit line can not be displayed and no limit check is possible.

The parameters form three groups: FLIN, FLOG, FSEG, and FSINGle select frequency units for the limit line. TLIN and TLOG select time units, PLIN, PLOG and PSINGle select power units.

\*RST: FLIN

Default unit: Hz (for FLIN, FLOG, FSEG, FSINGle); s (for TLIN, TLOG), dBm (for PLIN, PLOG, PSINGle).

**Example:**

```
SWE:TYPE LOG
```

Select a logarithmic frequency sweep.

```
CALC:LIM:CONT:DOM FLIN
```

Delete all existing limit ranges and select linear frequency units for the domain of the active trace.

```
CALC:LIM:CONT 1 GHz, 2 GHz
```

Define a limit line segment in the stimulus range between 1 GHz and 2 GHz.

**Usage:**

Setting only

**CALCulate<Chn>:LIMit:RDOMain:COMPLex <UnitRef>**

Deletes the existing limit line and (re-)defines the physical units of the response values of the limit line. The units of the stimulus values are defined via `CALCulate<Chn>:LIMit:CONTRol:DOMain`.

**Tip:** This command is complemented by `CALCulate<Chn>:LIMit:RDOMain:FORMat` and `CALCulate<Chn>:LIMit:RDOMain:SPACing`.

**Suffix:**

<Chn> Channel number used to identify the active trace.



**Setting parameters:**

<UnitRef> S | SINV | Y | Z | YREL | ZREL

Keyword for the physical unit of the response values. The parameters form four groups: S and SINV select relative units (dB) for the limit line. Y selects admittance units (S/Siemens). Z selects impedance units ( $\Omega$ ). YREL and ZREL select dimensionless numbers (U).

**Usage:** Setting only

**CALCulate<Chn>:LIMit:RDOMain:FORMat <UnitRef>**

Deletes the existing limit line and (re-)defines the physical units of the response values of the limit line. The units of the stimulus values are defined via [CALCulate<Chn>:LIMit:CONTrol:DOMain](#).

**Tip:** This command is complemented by [CALCulate<Chn>:LIMit:RDOMain:COMPLex](#) and [CALCulate<Chn>:LIMit:RDOMain:SPACing](#).

**Suffix:**

<Chn> Channel number used to identify the active trace.

**Setting parameters:**

<UnitRef> COMPLex | MAGNitude | PHASe | REAL | IMAGinary | SWR | GDElay | L | C

Keyword for the physical unit of the response values. The parameters form four groups: COMPLex, REAL, IMAGinary, and SWR select dimensionless numbers (U) for the limit line. MAGNitude selects relative units (dB). PHASe selects phase units (deg). GDElay selects time units (s). L selects inductance units (H/Henry). C selects capacitance units (F/Farad).

**Usage:** Setting only

**CALCulate<Chn>:LIMit:RDOMain:SPACing <Format>**

Deletes the existing limit line and (re-)defines the physical units of the response values of the limit line. The units of the stimulus values are defined via [CALCulate<Chn>:LIMit:CONTrol:DOMain](#).

**Tip:** This command is complemented by [CALCulate<Chn>:LIMit:RDOMain:COMPLex](#) and [CALCulate<Chn>:LIMit:RDOMain:FORMat](#).

**Suffix:**

<Chn> Channel number used to identify the active trace.

**Setting parameters:**

<Format> LINear | LOGarithmic | DB | SIC

Keyword for the physical unit of the response values.  
Default unit: dB (irrespective of the parameter selected)

**Usage:** Setting only

**CALCulate<Chn>:LIMit:LOWer:STATe** <Boolean>

**CALCulate<Chn>:LIMit:UPPer:STATe** <Boolean>

These commands switch the lower and upper limit check on or off. Lower limit line segments are assigned even numbers; upper limit line segments are assigned odd numbers; see [CALCulate<Chn>:LIMit:LOWer\[:DATA\]](#) and [CALCulate<Chn>:LIMit:UPPer\[:DATA\]](#). [CALCulate<Chn>:LIMit:LOWer:STATe](#) does not affect segments with odd numbers; [CALCulate<Chn>:LIMit:UPPer:STATe](#) does not affect segments with even numbers.

**Note:** Use [CALCulate<Chn>:LIMit:STATe](#) to switch on or off the entire limit check, including upper and lower limit lines.

**Suffix:**

<Chn> Channel number used to identify the active trace.

**Parameters:**

<Boolean> ON | OFF - switch limit check on or off.

\*RST: OFF

**Example:**

```
CALC:LIM:LOW -10, 0, 0, -10
```

Define two limit line segments covering the entire sweep range. Two upper limit line segments with default response values are created in addition.

```
CALC:LIM:UPP 0, 5, 5, 0
```

Change the response values of the upper limit line segments.

```
CALC:LIM:LOW:STAT ON; :CALC:LIM:UPP:STAT ON; :
CALC:LIM:FAIL?
```

Switch the limit check on and query the result.

**Manual operation:** See "[Limit Check](#)" on page 412

**CALCulate<Ch>:PARAmeter:DEFine** <TraceName>, <Result>[, <TestPortNum>]

Creates a trace and assigns a channel number, a name and a measurement parameter to it. The trace is not displayed. To display a trace defined via [CALCulate<Ch>:PARAmeter:DEFine](#), a window must be created ([DISPlay\[:WINDow<Wnd>\]\[:STATe\]](#) ON) and the trace must be assigned to this window ([DISPlay\[:WINDow<Wnd>\]:TRACe<WndTr>:FEED](#)); see example below.

Traces must be selected to become active traces; see [CALCulate<Ch>:PARAmeter:SElect](#).

**Note:** The parameter names in this command differ from R&S ZNL/ZNLE conventions; moreover the parameter list is not complete. The alternative command [CALCulate<Ch>:PARAmeter:SDEFine](#) uses a complete parameter list with compatible names.

**Suffix:**

<Ch> Channel number. <Ch> may be used to reference a previously defined channel. If <Ch> does not exist, it is generated with default channel settings.

**Setting parameters:**

|               |                                                                                                                                                                                                                                                                                                                                                                                                                                                                                                                                           |
|---------------|-------------------------------------------------------------------------------------------------------------------------------------------------------------------------------------------------------------------------------------------------------------------------------------------------------------------------------------------------------------------------------------------------------------------------------------------------------------------------------------------------------------------------------------------|
| <TraceName>   | Trace name, e.g. 'Trc4'. See "Rules for trace names" in " <a href="#">Table Area</a> " on page 333.                                                                                                                                                                                                                                                                                                                                                                                                                                       |
| <Result>      | S11   S12   S13   S14   S21   S22   S23   S24   S31   S32   S33   S34   S41   S42   S43   S44   A   B   C   D   R1   R2   R3   R4   AB   AC   AD   BA   BC   BD   CA   CB   CD   DA   DB   DC   AR1   AR2   AR3   AR4   BR1   BR2   BR3   BR4   CR1   CR2   CR3   CR4   DR1   DR2   DR3   DR4   R1A   R1B   R1C   R1D   R2A   R2B   R2C   R2D   R3A   R3B   R3C   R3D   R4A   R4B   R4C   R4D   R1R2   R1R3   R1R4   R2R1   R2R3   R2R4   R3R1   R3R2   R3R4   R4R1   R4R2   R4R3<br>Measurement parameter; see list of parameters below. |
| <TestPortNum> | Test port number, drive port for wave quantities and ratios, ignored for S-parameters.                                                                                                                                                                                                                                                                                                                                                                                                                                                    |

**Example:**

```
CALC4:PAR:DEF 'Ch4Tr1', S11
Create channel 4 and a trace named Ch4Tr1 to measure the
input reflection coefficient S11.
DISP:WIND:STAT ON
Create diagram area no. 1.
DISP:WIND:TRAC2:FEED 'CH4TR1'
Display the generated trace in diagram area no. 1, assigning a
trace number 2.
```

**Usage:** Setting only

The measurement parameter is selected by means of the following keywords (the selection depends on the number of test ports of the analyzer, e.g. S44 is not available on 2-port analyzers):

|                                                                                                                                                                                               |                                                                                                                                                                        |
|-----------------------------------------------------------------------------------------------------------------------------------------------------------------------------------------------|------------------------------------------------------------------------------------------------------------------------------------------------------------------------|
| S11   S12   S13   S14   S21   S22   S23   S24   S31   S32   S33   S34   S41   S42   S43   S44                                                                                                 | S-parameters                                                                                                                                                           |
| A   B   C   D                                                                                                                                                                                 | Wave quantities $b_1, b_2, b_3, b_4$ (received waves)                                                                                                                  |
| R1   R2   R3   R4                                                                                                                                                                             | Wave quantities $a_1, a_2, a_3, a_4$ (reference waves)                                                                                                                 |
| AB   AC   AD   BA   BC   BD   CA   CB   CD   DA   dB   DC                                                                                                                                     | Ratio of wave quantities $b_1/b_2, b_1/b_3, \dots, b_4/b_3$ (received waves only)                                                                                      |
| AR1   AR2   AR3   AR4   BR1   BR2   BR3   BR4   CR1   CR2   CR3   CR4   DR1   DR2   DR3   DR4   R1A   R1B   R1C   R1D   R2A   R2B   R2C   R2D   R3A   R3B   R3C   R3D   R4A   R4B   R4C   R4D | Ratio of wave quantities $b_1/a_1, b_1/a_2, \dots, b_4/a_4, a_1/b_1, a_1/b_2, \dots, A_4/B_4$ (received waves to reference waves or reference waves to received waves) |
| R1R2   R1R3   R1R4   R2R1   R2R3   R2R4   R3R1   R3R2   R3R4   R4R1   R4R2   R4R3                                                                                                             | Ratio of wave quantities $a_1/a_2, a_1/a_3, \dots, a_4/a_3$ (reference waves only)                                                                                     |

**CALCulate<Chn>:MARKer<Mk>:FUNCtion:BWIDth <Bandwidth>**

Defines the bandfilter level, i.e. the minimum excursion for the bandpass and bandstop peaks.

**Tip:** Use `CALCulate<Chn>:MARKer<Mk>:BWIDth` to set the bandwidth and query the results of a bandfilter search. Note the sign convention for input values.

**Suffix:**

`<Chn>` Channel number used to identify the active trace.

`<Mk>` This numeric suffix is ignored and may be set to any value because the bandfilter search functions always use markers M1 to M4.

**Parameters:**

`<Bandwidth>` Range: -100 dB to 100 dB  
 Increment: 0.03 dB  
 \*RST: 3 dB  
 Default unit: dB

**Example:** See `CALCulate<Chn>:MARKer<Mk>:BWIDth`

**CALCulate<Chn>:MARKer<Mk>:FUNCTION:DELTA:STATE <Boolean>**

Switches the delta mode for marker `<Mk>` on trace no. `<Chn>` on or off.

**Note:** This command is the ZVR-compatible equivalent of `CALCulate<Chn>:MARKer<Mk>:DELTA[:STATE]`.

**Suffix:**

`<Chn>` Channel number used to identify the active trace.

`<Mk>` Marker number.

**Parameters:**

`<Boolean>` ON | OFF - enable or disable the delta mode.  
 \*RST: OFF

**CALCulate<Chn>:MARKer<Mk>:FUNCTION:TARGET <SearchValue>**

Defines the target value for the target search of marker no. `<Mk>`, which can be activated using `CALCulate<Chn>:MARKer<Mk>:FUNCTION:EXECute TARGET`.

**Note:** This command is the ZVR-compatible equivalent of `CALCulate<Chn>:MARKer<Mk>:TARGET`.

**Suffix:**

`<Chn>` Channel number used to identify the active trace.

`<Mk>` Marker number.

**Parameters:**

|               |                                                                                                  |
|---------------|--------------------------------------------------------------------------------------------------|
| <SearchValue> | Target search value of marker no. <Mk>.                                                          |
| Range:        | Depending on the format of the active trace. For a dB Mag trace the range is -200 dB to +200 dB. |
| Increment:    | 0.1 dB                                                                                           |
| *RST:         | Depending on the trace format; 0 dB for a dB Mag trace.                                          |
| Default unit: | dB                                                                                               |

**CALCulate<Chn>:MARKer<Mk>:FUNction[:SElect] <Mode>**

Selects a search mode for marker no. <Mk>, which can then be initiated using one of the `CALCulate<Ch>:MARKer<Mk>:SEARCH...`, `CALCulate<Ch>:MARKer<Mk>:MAXimum` or `CALCulate<Ch>:MARKer<Mk>:MINimum` functions. The marker must be created before using `CALCulate<Chn>:MARKer<Mk>[:STATE]` ON.

**Note:** This command is not needed except for compatibility with ZVR programs. Use `CALCulate<Chn>:MARKer<Mk>:FUNction:EXECute` to select a search mode and at the same time initiate the search. The

`CALCulate<Ch>:MARKer<Mk>:SEARCH...`, `CALCulate<Ch>:MARKer<Mk>:MAXimum` or `CALCulate<Ch>:MARKer<Mk>:MINimum` functions also select the search mode.

**Suffix:**

|       |                                                                                                                                                                                                 |
|-------|-------------------------------------------------------------------------------------------------------------------------------------------------------------------------------------------------|
| <Chn> | Channel number used to identify the active trace.                                                                                                                                               |
| <Mk>  | Marker number. For a bandfilter search ( <code>BFILTER</code> ) this numeric suffix is ignored and may be set to any value because the bandfilter search functions always use markers M1 to M4. |

**Parameters:**

|        |                                                                                                                    |
|--------|--------------------------------------------------------------------------------------------------------------------|
| <Mode> | MAXimum   MINimum   RPEak   LPEak   NPEak   TARGet   LTARget   RTARget   BFILter   MMAXimum   MMINimum   SPRogress |
|        | See <code>CALCulate&lt;Chn&gt;:MARKer&lt;Mk&gt;:FUNction:EXECute</code>                                            |

**CALCulate<Chn>:MARKer<Mk>:MAXimum****CALCulate<Chn>:MARKer<Mk>:MINimum**

These commands select a search mode for marker no. <Mk> and initiate a maximum and minimum search, respectively. The marker must be created before using `CALCulate<Chn>:MARKer<Mk>[:STATE]` ON.

**Note:** This commands are the ZVR-compatible equivalent of `CALCulate<Chn>:MARKer<Mk>:FUNction:EXECute` MINimum | MAXimum.

**Suffix:**

|       |                                                   |
|-------|---------------------------------------------------|
| <Chn> | Channel number used to identify the active trace. |
| <Mk>  | Marker number.                                    |

**Usage:** Event

---

**CALCulate<Chn>:MARKer<Mk>:SEARch:LEFT**  
**CALCulate<Chn>:MARKer<Mk>:SEARch:NEXT**  
**CALCulate<Chn>:MARKer<Mk>:SEARch:RIGHT**

These commands selects a search mode for marker no. <Mk> and initiate a search for the next valid peak to the left, the next highest or lowest value among the valid peaks, and the next valid peak to the right. The marker must be created before using `CALCulate<Chn>:MARKer<Mk>[:STATe] ON`.

**Note:** These commands are the ZVR-compatible equivalents of `CALCulate<Chn>:MARKer<Mk>:FUNCTION:EXECute LPEak | NPEak | RPEak`.

**Suffix:**

<Chn> Channel number used to identify the active trace.

<Mk> Marker number.

**Usage:** Event

---

**CALCulate<Chn>:MARKer<Mk>:SEARch[:IMMEDIATE]**

Initiates a search according to the search function selected with `CALCulate<Chn>:MARKer<Mk>:FUNCTION[:SElect]`. The marker must be created before using `CALCulate<Chn>:MARKer<Mk>[:STATe] ON`.

**Note:** Together with `CALCulate<Chn>:MARKer<Mk>:FUNCTION[:SElect]` this command is the ZVR-compatible equivalent of `CALCulate<Chn>:MARKer<Mk>:FUNCTION:EXECute`.

**Suffix:**

<Chn> Channel number used to identify the active trace.

<Mk> Marker number. For a bandfilter search (`BFIltEr`) this numeric suffix is ignored and may be set to any value because the bandfilter search functions always use markers M1 to M4.

**Usage:** Event

---

**CALCulate<Chn>:MATH[:EXPRession][:DEFine] <Expression>**

Defines a simple mathematical relation between traces. To calculate and display the new mathematical trace, the mathematical mode must be switched on (`CALCulate<Chn>:MARKer<Mk>[:STATe] ON`).

**Note:** This command places some restrictions on the mathematical expression and the operands. Use `CALCulate<Chn>:MATH[:EXPRession]:SDEFine` to define general expressions.

**Suffix:**

<Chn> Channel number used to identify the active trace.

**Parameters:**

&lt;Expression&gt;

&lt;expr&gt;

(<operand1><operator1><operand2> [<operator2><operand3>]) The expression must be enclosed in brackets.

Operands: See list of trace names in [Chapter 11.5.2.17, "TRACe Commands"](#), on page 927.

Operators: +, -, \*, /

**Example:**

```
*RST; CALC:MATH:MEM
```

Copy the current state of the default trace Trc1 to a memory trace named "Mem2[Trc1]". The memory trace is not displayed.

```
CALC:MATH (CH1DATA / MDATA2)
```

Define a mathematical trace, dividing the data trace by the stored memory trace. The mathematical trace is not displayed

```
CALC:MATH:STAT ON
```

Display the mathematical trace instead of the active data trace.

**DIAGnostic:SERvice:FUNCTion** <SFId1>, <SFId2>...

Activates a service function (mainly for internal use). Service functions are identified by groups of numbers, separated by dots.

**Parameters:**

&lt;SFId1&gt;

&lt;SFId2&gt;

Service function identifier entered as a (pseudo-)numeric value, the dots being replaced by commas. Five groups of numbers are allowed at maximum. See also [DIAGnostic:SERvice:SFUNCTion](#).

**FORMat:DEXPort:SOURce** <Format>

Defines the format for traces retrieved with the R&S ZVR-compatible command [TRACe \[:DATA\] \[:RESPonse\] \[:ALL\] ?](#).

This command is not relevant for results read with the [CALCulate<Chn>:DATA...](#) commands.

**Parameters:**

&lt;Format&gt;

FDATa | SDATa | MDATa

See list of parameters below. The unit is the default unit of the measured parameter; see [CALCulate<Ch>:PARAmeter:SDEFine](#).

Range: Depending on the measured parameter and format.

\*RST: SDATa

**Example:**

See [TRACe \[:DATA\] \[:RESPonse\] \[:ALL\] ?](#)

The following parameters are related to trace data:

|       |                                                                                                                                                                                                 |
|-------|-------------------------------------------------------------------------------------------------------------------------------------------------------------------------------------------------|
| FDATA | Formatted trace data, according to the selected trace format ( <code>CALCulate&lt;Chn&gt;:FORMat</code> ). 1 value per trace point for Cartesian diagrams, 2 values for polar diagrams.         |
| SDATA | Unformatted trace data: Real and imaginary part of each measurement point. 2 values per trace point irrespective of the selected trace format. The trace mathematics is not taken into account. |
| MDATA | Unformatted trace data (see <code>SDATA</code> ) after evaluation of the trace mathematics.                                                                                                     |

### INPut<PhyPt>:ATTenuation <Attenuation>

Sets the attenuation for the received waves. This command is available if at least one of the [Receiver Step Attenuators](#) is installed.

#### Note:

- `INPut<PhyPt>:ATTenuation` is not channel-specific; the value is valid for **all channels**. Use `[SENSe<Ch>:]POWer:ATTenuation` to set or query a channel-specific attenuation value.

#### Suffix:

<PhyPt> Physical port number; if unspecified the numeric suffix is set to 1

#### Parameters:

<Attenuation>

Attenuation factor for the received wave.

Range: 0 dB, 10 dB, 20 dB, 30 dB. UP and DOWN increment/decrement the attenuation in 10 dB steps. The analyzer rounds any entered value below the maximum attenuation to the closest step.

\*RST: 0 dB

Default unit: dB

#### Example:

```
INP2:ATT 10
```

Set the step attenuator for the wave received at port 2 and for all channels to 10 dB. The waves at the other test ports are not affected.

```
SENS1:POW:ATT? BREC
```

Query the receiver step attenuator setting at port 2 and for channel no. 1. The response is 10.

### INSTrument[:SElect] <Channel>

Selects a channel <Ch> as active channel. To select a channel number > 4 use the generalized command `INSTrument:NSElect`.

#### Parameters:

<Channel>

CHANnel1 | CHANnel2 | CHANnel3 | CHANnel4

Number of the channel to be activated. The channel must be created before using `CONFigure:CHANnel<Ch>[:STATE] ON`.

\*RST: CHANNEL1



**Example:** `CONF:CHAN2:STAT ON; :INST CHANnel2`  
Create channel no. 2 and select it as the active channel.

---

### OUTPut<Chn>:DPORt <Port>

Selects a source port for the stimulus signal (drive port). The setting acts on the active trace. The effect of the drive port selection depends on the measurement parameter associated to the active trace:

- If an S-parameter  $S_{\langle out \rangle \langle in \rangle}$  is measured, the second port number index <in> (input port of the DUT = drive port of the analyzer) is set equal to the selected drive port: Drive port selection affects the measured quantity.
- If a wave quantity or a ratio is measured, the drive port is independent from the measured quantity:

**Suffix:**

<Chn> Channel number used to identify the active trace

**Parameters:**

<Port> PORT<no>  
Physical port number.  
\*RST: PORT1

**Example:** `CALC4:PAR:SDEF 'Ch4Tr1', 'A1'`  
Create channel 4 and a trace named "Ch4Tr1" to measure the wave quantity  $a_1$ . The trace automatically becomes the active trace.  
`OUTP4:DPOR PORT2`  
Select drive port 2 for the active trace.

---

**[SENSe<Ch>:]CORRection:CKIT:<ConnType>:<StandardType>** <CalkitName>, <Standard>, <MinFreq>, <MaxFreq>, <DelayParam>, <Loss>, <C0>, <L0>, <C1>, <L1>, <C2>, <L2>, <C3>, <L3>, OPEN | SHORT

Defines the parameters of a calibration standard <StandardType> for a specified connector type <ConnType>. A particular physical standard can be selected by specifying the name of the calibration kit and its serial number. Depending on the standard type, only a subset of the parameters may be used; see [Standard types and their parameters](#).

**Note:** If the specified cal kit does not exist, it is created with the specified calibration standard.

**Suffix:**

<Ch> Channel number. This suffix is ignored because calibration kits are channel-independent.

**Parameters:**

<ConnType> Connector type, one of the following identifiers:  
N50, N75: N 50  $\Omega$  or N 75  $\Omega$  connectors  
PC7, PC35, PC292: PC 7, PC 3.5 or 2.92 mm connectors

|                 |                                                                                                                                                                                                                                                                                                                                                                                                                                                                                    |
|-----------------|------------------------------------------------------------------------------------------------------------------------------------------------------------------------------------------------------------------------------------------------------------------------------------------------------------------------------------------------------------------------------------------------------------------------------------------------------------------------------------|
|                 | <p>USER&lt;no&gt;: User-defined connectors UserConn1, UserConn2</p> <p>SMA: User-defined connector type SMA ...</p> <p><b>Note:</b> This command only supports ZVR-compatible connector types. For general definitions use <a href="#">[SENSe:]CORRection:CKIT:&lt;StandardType&gt;</a>.</p>                                                                                                                                                                                       |
| <StandardType>  | <p>Standard type. For reflection standards, the first character denotes the gender, e.g.:</p> <p>FOPEN, MOPEN: Open (f) or Open (m) standard.</p> <p>For transmission standards, the first two characters denotes the genders on both ends, e.g.:</p> <p>FFSNetwork, MFSNetwork, MMSNetwork: Symm. network (ff), symm. network (mf) or symm. network (mm) standard.</p> <p>For a complete list of standard types refer to <a href="#">Standard types and their parameters</a>.</p> |
| Parameter list  | <p>String parameters to specify the configured standard (&lt;CalkitName&gt;, &lt;StandardLabel&gt;) and numeric parameters defining its properties. See <a href="#">Parameter list</a>.</p> <p>*RST:           n/a</p>                                                                                                                                                                                                                                                             |
| <b>Example:</b> | <pre>CORR:CKIT:N50:FOPEN 'ZV-Z21','', 0,1.8E+010,0.0151,0,0,0.22,-0.22,0.0022</pre> <p>Define the properties of the open (f) standard for the N 50 Ω connector type contained in the ZV-Z21 calibration kit: Assign a valid frequency range of 0 Hz to 18 GHz, an electrical length of 15.1 mm, 0 dB loss and define the polynomial coefficients of the fringing capacitance as 0 fF, 0.22 fF/GHz, -0.22 fF/(GHz)<sup>2</sup>, 0.0022 fF/(GHz)<sup>3</sup>.</p>                    |

---

### [SENSe:]CORRection:CKIT:INSTall <CalKitFile>

Lloads cal kit data from a specified R&S ZVR cal kit file.

#### Setting parameters:

|              |                                                                                                                                                                                                                                                                                                                                                                                           |
|--------------|-------------------------------------------------------------------------------------------------------------------------------------------------------------------------------------------------------------------------------------------------------------------------------------------------------------------------------------------------------------------------------------------|
| <CalKitFile> | <p>String parameter to specify the name and directory of the cal kit file to be loaded.</p> <p><b>Note:</b> The loaded file must be a R&amp;S ZVR-specific cal kit file with the extension *.ck. VNA cal kit files (*.calkit) can be imported using the <a href="#">MMEMory:LOAD:CKIT</a> command. Keysight cal kit files can be imported manually and converted into *.calkit files.</p> |
|--------------|-------------------------------------------------------------------------------------------------------------------------------------------------------------------------------------------------------------------------------------------------------------------------------------------------------------------------------------------------------------------------------------------|

**Example:**

```
CORR:CKIT:INST 'C:\Users\Public\Documents
\Rohde-Schwarz\ZNL\Calibration\Kits\ZCAN.ck'
Load the previously created R&S ZVR cal kit file ZCAN.ck from
the default cal kit directory.
MMEM:STOR:CKIT 'ZCAN', 'C:
\Users\Public\Documents
\Rohde-Schwarz\ZNL\Calibration\Kits\ZCAN.calkit'
Store the imported cal kit data to a VNA cal kit file
ZCAN.calkit (assuming that the cal kit name stored in
ZCAN.ck reads "ZCAN").
```

**Usage:** Setting only

---

**[SENSe<Ch>:]CORRection:COLLect[:ACQuire] <Standard>[, <Dispersion>[, <Delay>]]**

Starts a calibration measurement in order to acquire measurement data for the selected standards. The standards are reflection or transmission standards and must be connected to port 1 or 2 of the analyzer.

**Tip:** Use the generalized command `[SENSe<Ch>:]CORRection:COLLect[:ACQuire]:SElected` to obtain measurement data at arbitrary analyzer ports.

**Suffix:**

<Ch> Channel number of the calibrated channel.

**Setting parameters:**

<Standard> THROugh | OPEN1 | OPEN2 | OPEN12 | SHORt1 | SHORt2 | SHORt12 | MATCh1 | MATCh2 | MATCh12 | NET | ATT | IMATCh12 | REFL1 | REFL2 | SLIDe1 | SLIDe2 | SLIDe12 | LINe1 | LINe2 | LINe3 | M1O2 | O1M2 | OSHort1 | OSHort11 | OSHort12 | OSHort13 | OSHort2 | OSHort21 | OSHort22 | OSHort23 | M1S2 | S1M2 | UTHRough

Standard types: Through (between port 1 and 2), Open, Short, Match (MATCh12 and IMATCh12 are synonymous), Symmetric Network (NET), Attenuation (ATT), Reflect, Sliding Match (SLIDe), Line1 (LINe1 and LINE are synonymous), Line2 and Line3 (esp. for TRL calibration), Match/Open (M1O2, O1M2), Match/Short (M1S2, S1M2), Offset Short (OSHort), Unknown Through (UTHRough).

The numbers in the parameter names denote the analyzer ports. Two numbers 12 mean that two separate calibrations are performed at ports 1 and 2. For Offset Short standards, the first number denotes the port (1 or 2), the second number denotes the number of the standard (1 to 3).

\*RST: ON

<Dispersion> Optional status parameter for UTHRough standard:  
 OFF - unknown through standard is non-dispersive.  
 ON - unknown through standard is dispersive.

\*RST: OFF

|                      |                                                                                                                                                                                                                                                                                                                                                                                                                                                                           |
|----------------------|---------------------------------------------------------------------------------------------------------------------------------------------------------------------------------------------------------------------------------------------------------------------------------------------------------------------------------------------------------------------------------------------------------------------------------------------------------------------------|
| <b>&lt;Delay&gt;</b> | Optional entry of delay time or phase for UTHRough standard:<br><numeric> - entry of the delay time in ps (for non-dispersive standards) or of an estimate of the phase at the start frequency of the sweep in deg (for dispersive standards). See also background information for <a href="#">[SENSe&lt;Ch&gt;:]CORRection:COLLect[:ACQuire]:SELected</a> .<br>AUTO - the analyzer determines the delay time or phase during the calibration sweep.<br>*RST:        AUTO |
| <b>Example:</b>      | See <a href="#">[SENSe&lt;Ch&gt;:]CORRection:COLLect:SAVE[:DUMMy]</a>                                                                                                                                                                                                                                                                                                                                                                                                     |
| <b>Usage:</b>        | Setting only                                                                                                                                                                                                                                                                                                                                                                                                                                                              |

---

### **[SENSe<Ch>:]CORRection:COLLect:METHod <CalType>**

Selects a one-port or two-port calibration type for channel <Ch> at ports 1/2.

**Tip:** Use the generalized command [\[SENSe<Ch>:\]CORRection:COLLect:METHod:DEFine](#) to select the calibration type for arbitrary analyzer ports or a multiport calibration type.

**Suffix:**

<Ch>                      Channel number of the calibrated channel.

**Parameters:**

<CalType>                FRTRans | PFRTrans | FTRans | PFTRans | RTRans | PRTRans | TOM | TSM | TRM | TRL | TNA | TOSM | ETOM | ETSM | FOPort1 | FOPort2 | FOPort12 | FOPTport | ROPTport | REFL1 | REFL2 | REFL12 | TPORT | UOSM  
 Calibration types, TOM, TRM, TRL, TNA, TOSM, Full One Port, One Path Two Port, Normalization (REFL1, REFL2 and REFL12 for one-port, FRTRans, FTRans, RTRans, and TPORT for two-port), TOSM with unknown through.  
 The numbers in the parameters denote the analyzer ports.  
 Parameters for two-port calibration types contain no numbers because the command is only valid for ports 1 and 2.

**Example:**              See [\[SENSe<Ch>:\]CORRection:COLLect:SAVE\[:DUMMy\]](#)

---

### **[SENSe<Ch>:]CORRection:COLLect:SAVE:DEFault**

Generates a set of default system error correction data for the selected ports and calibration type. The default data set corresponds to a test setup which does not introduce any systematic errors; none of the measurement results acquired previously ([\[SENSe<Ch>:\]CORRection:COLLect\[:ACQuire\]](#)) is taken into account.

**Tip:** The main purpose of the default correction data set is to provide a dummy system error correction which you can replace with your own, external correction data. You may have acquired the external data in a previous session or even on an other instrument. If you want to use the external correction data on the analyzer, simply generate the default data set corresponding to your port configuration and calibration type and overwrite the default data. For details refer to the program example below.

**Note:** This command must be used in combination with the R&S ZVR-compatible commands `[SENSe<Ch>:]CORRection:COLLect:METhod` and `[SENSe<Ch>:]CORRection:DATA`. Use `[SENSe<Ch>:]CORRection:COLLect:SAVE:SELEcted:DEFault` if you want to use R&S ZNL/ZNLE-specific calibration commands or if you want to calibrate more than 2 ports.

**Suffix:**

<Ch> Channel number of the calibrated channel

**Example:**

```
CORR:COLL:METh REFL1
```

Select a one-port normalization at port 1 with an open standard as calibration type.

```
CORR:COLL:SAVE:DEF
```

Calculate a dummy system error correction for the normalization at port 1. The dummy system error correction provides the reflection tracking error term SCORR3.

```
INIT:CONT OFF; :INIT; *WAI
```

Stop the sweep to ensure correct transfer of calibration data.

```
CORR:DATA? 'SCORR3'
```

Query the dummy system error correction term. The response is a 1 (written as 1, 0 for the real and imaginary part) for each sweep point (no attenuation and no phase shift between the analyzer and the calibration plane).

```
CORR:DATA 'SCORR3', <ASCII_data>
```

Replace the dummy system error correction term with your own correction data, transferred in ASCII format.

```
INIT:CONT ON
```

Restart the sweep in continuous mode.

**Usage:** Event

**[SENSe<Ch>:]CORRection:COLLect:SAVE[:DUMMy]**

Calculates the system error correction data from the acquired one or two-port measurement results (`[SENSe<Ch>:]CORRection:COLLect[:ACQuire]`), stores them and applies them to the calibrated channel <Ch>. To avoid incompatibilities, older system error correction data is deleted unless it has been transferred into a cal pool (`MMEMory:STORe:CORRection`).

This command is the R&S ZVR-compatible equivalent of `[SENSe<Ch>:]CORRection:COLLect:SAVE:SELEcted[:DUMMy]`. It must be used in combination with the R&S ZVR-compatible commands for calibration method and standard selection; see example below.

|                 |                                                                                                                                                                                                                                                                                                                                                          |
|-----------------|----------------------------------------------------------------------------------------------------------------------------------------------------------------------------------------------------------------------------------------------------------------------------------------------------------------------------------------------------------|
| <b>Suffix:</b>  |                                                                                                                                                                                                                                                                                                                                                          |
| <Ch>            | Channel number of the calibrated channel.                                                                                                                                                                                                                                                                                                                |
| <b>Example:</b> | <pre>CORR:COLL:METH REFL1</pre> <p>Select a one-port normalization at port 1 as calibration type.</p> <pre>CORR:COLL OPEN1</pre> <p>Measure an open standard connected to port 1 and store the measurement results of this standard.</p> <pre>CORR:COLL:SAVE</pre> <p>Calculate the system error correction data and apply it to the active channel.</p> |
| <b>Usage:</b>   | Event                                                                                                                                                                                                                                                                                                                                                    |

---

### [SENSe<Ch>:]CORRection:DATA <ErrorTerm>, <Parameter>...

Writes or reads system error correction data for a specific channel <Ch> and calibration method ([SENSe<Ch>:]CORRection:COLLect:METhod). The analyzer test ports 1 or 2 are implicitly specified with the correction terms. The setting command can be used to transfer user-defined correction data to the analyzer; the query returns the current correction data set. ASCII or block data can be transferred, depending on the selected data transfer format (FORMat[:DATA])

The sweep must be stopped to transfer calibration data; see program example for [SENSe<Ch>:]CORRection:COLLect:SAVE:DEFault.

**Note:** This command affects the active calibration of channel no. <Ch> or the factory calibration (if no channel calibration is active). For the factory calibration, the query form is allowed only (no change of factory calibration data).

**Tip:** Use the generalized command [SENSe<Ch>:]CORRection:CDATa to transfer calibration data for arbitrary analyzer ports. The analyzer provides a default calibration corresponding to a test setup which does not introduce any systematic errors; see [SENSe<Ch>:]CORRection:COLLect:SAVE:DEFault.

### G and H matrices

The 7-term calibration types named Txx (e.g. TOM, TSM, TRM, TRL, TNA) are based on a network analyzer with two ports i and j, each equipped with a test receiver and a reference receiver. The system errors are described in terms of two "error two-ports" P<sub>G</sub> and P<sub>H</sub>:

- The error two-port P<sub>G</sub> is assigned to port i of the analyzer. Its transmission matrix G describes how the system errors modify the outgoing and incident waves at port i:

$$\begin{bmatrix} \mathbf{b}_i \\ \mathbf{a}_i \end{bmatrix} = \begin{bmatrix} \mathbf{G}_{11} & \mathbf{G}_{12} \\ \mathbf{G}_{21} & \mathbf{G}_{22} \end{bmatrix} * \begin{bmatrix} \mathbf{m}_{i\text{ref}} \\ \mathbf{m}_{i\text{test}} \end{bmatrix}$$

- The error two-port P<sub>H</sub> is assigned to port j of the analyzer. Its transmission matrix H describes how the system errors modify the measured incident and outgoing waves at port j:

$$\begin{bmatrix} \mathbf{a}_j \\ \mathbf{b}_j \end{bmatrix} = \begin{bmatrix} \mathbf{H}_{11} & \mathbf{H}_{12} \\ \mathbf{H}_{21} & \mathbf{H}_{22} \end{bmatrix} * \begin{bmatrix} \mathbf{m}_{j\text{test}} \\ \mathbf{m}_{j\text{ref}} \end{bmatrix}$$

In the two equations above, a and b denote the waves at the calibrated reference plane i and j (e.g. the input and output of the 2-port DUT). The m waves are the raw measured waves of test port i and j. The subscripts "ref" and "test" refer to the reference and test receivers, respectively. During the calibration the network analyzer acquires ratios of wave quantities, which leaves one of non-diagonal matrix elements of G or H as a free normalization factor. The network analyzer uses the normalization  $H_{21} = 1$ .

**Suffix:**

<Ch> Channel number of the calibrated channel

**Parameters:**

<ErrorTerm> String parameters describing the different error terms, depending on the current calibration method; see table below. Each term contains one complex value (real and imaginary part) for each sweep point. The parameters must be transferred in full length. The following strings are allowed:

- 'SCORR1' - directivity at port 1
- 'SCORR2' - source match at port 1
- 'SCORR3' - reflection tracking at port 1
- 'SCORR4' - reserved for future extensions
- 'SCORR5' - load match at port 2
- 'SCORR6' - forward transmission tracking between port 1 and port 2
- 'SCORR7' - directivity at port 2
- 'SCORR8' - source match at port 2
- 'SCORR9' - reflection tracking at port 2
- 'SCORR10' - reserved for future extensions
- 'SCORR11' - load match at port 1
- 'SCORR12' - reverse transmission tracking between port 2 and port 1
- 'G11' ... 'G22' - G matrix elements; see above
- 'H22' - H matrix elements; see above

The error terms are dimensionless complex numbers.

\*RST: n/a

<Parameter>

**Example:** See `[SENSe<Ch>:]CORRection:COLLect:SAVE:DEFault`

The different calibration types of the analyzer provide the following error terms:

| Calibration type                                           | Parameter in [SENSe<Ch>:]CORRection:COLLect:MEthod | Available error terms (depending on port numbers)                                                                                                                                                            |
|------------------------------------------------------------|----------------------------------------------------|--------------------------------------------------------------------------------------------------------------------------------------------------------------------------------------------------------------|
| One-port normalization (reflection) using an open standard | REFL1<br>REFL2<br>REFL12                           | 'SCORR3'<br>'SCORR9'<br>'SCORR3' and 'SCORR9'                                                                                                                                                                |
| Full one port                                              | FOPort1<br>FOPort2<br>FOPort12                     | 'SCORR1' to 'SCORR3'<br>'SCORR7' to 'SCORR9'<br>'SCORR1' to 'SCORR3' and 'SCORR7' to 'SCORR9'                                                                                                                |
| Two-port normalization                                     | FTRans<br>RTRans<br>FRTRans                        | 'SCORR6'<br>'SCORR12'<br>'SCORR6' and 'SCORR12'                                                                                                                                                              |
| One path two port                                          | FOPTport<br>ROPTport                               | 'SCORR1' to 'SCORR3', 'SCORR6'<br>'SCORR7' to 'SCORR9', 'SCORR12'                                                                                                                                            |
| TOSM                                                       | TOSM                                               | 'SCORR1' to 'SCORR12'<br>(at present the isolation terms 'SCORR4' and 'SCORR10' are not included)                                                                                                            |
| TOM, TSM, TRM, TRL, TNA                                    | TOM   TRM   TRL   TNA                              | 'DIRECTIVITY', 'SRCMATCH', 'REFLTRACK', 'LOADMATCH', 'TRANSTRACK' (for reading and writing)<br><br>'G11' ... 'G22' and 'H11', 'H12', 'H22' (for reading only; the 'H21' matrix elements are normalized to 1) |

### [SENSe<Ch>:]CORRection:OFFSet<PhyPt>:MAGNitude <OffsetLoss>

Defines the frequency-independent part (DC value) of the offset loss.

**Tip:** Use the [SENSe<Ch>:]CORRection:LOSS<PhyPt>... commands to define the complete set of loss offset parameters.

[SENSe<Ch>:]CORRection:OFFSet<PhyPt>:MAGNitude is equivalent to [SENSe<Ch>:]CORRection:LOSS<PhyPt>:OFFSet.

#### Suffix:

<Ch> Channel number of the offset-corrected channel

<PhyPt> Port number of the analyzer

#### Parameters:

<OffsetLoss> Frequency-independent part of the offset loss

Range: -200 dB to +200 dB

Increment: 0.0001 dB

\*RST: 0 dB

Default unit: dB



**[SENSe<Ch>:]FREQuency:MODE <FreqSweep>**

Selects the sweep type and defines which set of commands controls the stimulus frequency.

**Tip:** The command `[SENSe<Ch>:]SWEep:TYPE` provides a complete list of sweep types.

**Suffix:**

<Ch> Channel number

**Parameters:**

<FreqSweep> CW | FIXed | SWEep | SEGment

Linear or logarithmic frequency sweep, depending on the selected spacing (`[SENSe<Ch>:]SWEep:SPACing LINear | LOGarithmic`). The frequency range is set via `[SENSe<Ch>:]FREQuency:START` etc.

**Example:**

```
FREQ:MODE CW
Activate a time sweep.
FREQ: CW 100MHz
Set the CW frequency to 100 MHz.
```

**[SENSe<Ch>:]SEGment<Seg>:CLEar**

Deletes all sweep segments in the channel. The command is equivalent to `[SENSe<Ch>:]SEGment<Seg>:DELeTe:ALL`.

**Suffix:**

<Ch> Channel number

<Seg> Sweep segment number. This suffix is ignored; the command deletes all segments.

**Usage:**

Event

**[SENSe<Ch>:]SEGment<Seg>:OVERlap <Boolean>**

Queries whether the analyzer supports overlapping sweep segments.

**Suffix:**

<Ch> Channel number. This suffix is ignored; the command is instrument-specific.

<Seg> Sweep segment number. This suffix is ignored; the command is instrument-specific.

**Parameters:**

<Boolean> ON | OFF: No effect.

\*RST: ON. If used as a query, the command returns the information that overlapping sweep segments are supported (ON).

**[SENSe<Ch>:]SWEep:SPACing <StimulusFreq>**

Defines the frequency vs. time characteristics of a frequency sweep ("Lin Frequency" or "Log Frequency"). The command has no effect on segmented frequency or time sweeps.

**Note:** Use [SENSe<Ch>:]SWEep:TYPE to select sweep types other than "Lin Frequency" or "Log Frequency".

**Suffix:**

<Ch> Channel number

**Parameters:**

<StimulusFreq> LINear | LOGarithmic

The stimulus frequency is swept in equidistant steps over the frequency range. In a Cartesian diagram, the x-axis is a linear frequency axis.

**Example:**

```
FUNC "XFR:POW:S12"
```

Activate a frequency sweep and select the S-parameter  $S_{12}$  as measured parameter for channel and trace no. 1.

```
SWE:SPAC LOG
```

Change to sweep type "Log Frequency".

**[SENSe<Chn>:]FUNction[:ON] <SweepType>[, <arg1>[, <arg2>]]**

Defines the sweep type and the measurement parameter in a single string.

**Note:** To select a measurement parameter without changing the sweep type, use CALCulate<Ch>:PARAmeter:MEASure. Use the other commands in the CALCulate<Ch>:PARAmeter... subsystem to create or delete traces and select measurement parameters.

**Suffix:**

<Chn> Channel number used to identify the active trace. If [SENSe<Chn>:]FUNction[:ON] is not used as a query, the number must be 1.

**Parameters:**

<SweepType> Single string parameter defining the sweep type and the parameter to be measured:

```
<string> = "<sweep_type>:<parameter>"
```

Range: See list of strings below.

```
*RST: "XFR:POW:S21"
```

<arg1> B1 | B2 | A1 | A2 | ABSa1 | ABSa2 | DCIN1 | DCIN2

<arg2> B1 | B2 | A1 | A2 | ABSa1 | ABSa2 | DCIN1 | DCIN2

**Example:**

```
CALC4:PAR:SDEF "Ch4Tr1", "S11"
```

Create channel 4 and a trace named "Ch4Tr1" to measure the input reflection coefficient  $S_{11}$ . The trace automatically becomes the active trace.

```
SENS4:FUNC?
```

Check (query) the sweep type and measurement parameter of the active trace. The result is 'XFR:POW:S11'.

The following keywords define the sweep type (see SCPI command reference: presentation layer):

|             |                                                                     |
|-------------|---------------------------------------------------------------------|
| XFRrequency | Frequency sweep (Lin. Frequency/Log. Frequency/Segmented Frequency) |
| XTIME       | Time sweep                                                          |
| XCW?        | CW Mode sweep (output variable for query only)                      |

The following keywords define the measurement parameter (see SCPI command reference: function name):

|                                                                                   |                                                                                                                             |
|-----------------------------------------------------------------------------------|-----------------------------------------------------------------------------------------------------------------------------|
| POWer:S<Ptout><Ptin>                                                              | S-parameter with output and input port number of the DUT, e.g. $S_{11}$ , $S_{21}$ .                                        |
| POWer:RATio A<Ptout>   B<Ptin>,<br>A<Ptout>   B<Ptin><br>Output: A<Ptout>/B<Ptin> | Ratio, e.g. $B_2/A_1$ for $b_2/a_1$ drive Port 1                                                                            |
| POWer:A<Ptout>                                                                    | Wave quantity with stimulus port number of the analyzer, e.g. $a_1$ .                                                       |
| POWer:B<Ptin>                                                                     | Wave quantity with receive port number of the analyzer, e.g. $b_2$ .                                                        |
| POWer:Z<Ptout><Ptin>                                                              | Matched-circuit impedance (converted Z-parameter) with output and input port number of the DUT, e.g. $Z_{11}$ , $Z_{21}$ .  |
| POWer:Y<Ptout><Ptin>                                                              | Matched-circuit admittance (converted Y-parameter) with output and input port number of the DUT, e.g. $Y_{11}$ , $Y_{21}$ . |
| POWer:KFACTOR<br>POWer:MUFACTOR<Lev>                                              | Stability factor K<br>Stability factors $\mu_1$ or $\mu_2$                                                                  |
| VOLTage[:DC] DCIN1   DCIN2<br>Output: DC 1 V, DC 10 V                             | DC Input 1 or 2                                                                                                             |

**Note:** The mnemonics POWER: and VOLTage: are not used in output strings.

**TRACe:CLEAr <MemTrace>**

Deletes one of the memory traces Mem<n> [Trc<m>], where n = 1, ... 8.

**Setting parameters:**

<MemTrace> MDATa1 | MDATa2 | MDATa3 | MDATa4 | MDATa5 | MDATa6 | MDATa7 | MDATa8

Identifier for the memory trace; see [Table 11-20](#).

Range: MDATA<n> where <n> = 1 to 8.

**Example:**

```
SWE:POIN 20
```

Create a trace with 20 sweep points, making the created trace the active trace of channel 1 (omitted optional mnemonic SENSE1).

```
TRAC:COPY "Mem_Pt20", CH1DATA
```

Copy the current state of the created trace to a memory trace named "Mem\_Pt20". The memory trace is not displayed.

```
DISP:WIND:TRAC2:FEED "MEM_PT20"
```

Display the created memory trace in the active diagram area (diagram area no. 1).

**Usage:**

Setting only

**TRACe[:DATA][:RESPonse][:ALL]? <Response>**

Returns the response values of the active data trace or memory trace (see [Table 11-20](#)).

**Note:** To read the response values of an arbitrary data or memory trace, use `CALCulate<Chn>:DATA`. To read the response values of a trace acquired in single sweep mode (`INITiate<Ch>:CONTinuous OFF`), use `CALCulate<Chn>:DATA:NSweep:FIRSt?`.

**Query parameters:**

<Response> CH1Data | CH2Data | CH3Data | CH4Data | CH1Mem | CH2Mem | CH3Mem | CH4Mem | MDATa1 | MDATa2 | MDATa3 | MDATa4 | MDATa5 | MDATa6 | MDATa7 | MDATa8

Response data of the selected trace, see [Table 11-20](#).

The data is transferred in the data format defined via `FORMat[:DATA]` and `FORMat:DEXPort:SOURce`. The unit is the default unit of the measured parameter; see `CALCulate<Ch>:PARAmeter:SDEFine`.

**Example:**

```
SWE:POIN 20
```

Create a trace with 20 sweep points, making the created trace the active trace of channel 1 (omitted optional mnemonic SENSE1).

```
CALC:FORM MLIN; :FORM ASCII; FORM:DEXP:SOUR
FDAT
```

Select the trace data format: linear magnitude values, ASCII format and formatted trace data (1 value per sweep point).

```
TRAC? CH1DATA
```

Query the 20 response values of the created trace according to the previous format settings.

**Usage:** Query only

---

**TRACe[:DATA]:STIMulus[:ALL]? <Stimulus>**

Returns the stimulus values of the active data trace or memory trace (see [Table 11-20](#)).

**Note:** To read the stimulus values of an arbitrary data or memory trace, use

`CALCulate<Chn>:DATA:STIMulus?`

**Query parameters:**

<Stimulus> CH1Data | CH2Data | CH3Data | CH4Data | CH1Mem | CH2Mem | CH3Mem | CH4Mem | MDATa1 | MDATa2 | MDATa3 | MDATa4 | MDATa5 | MDATa6 | MDATa7 | MDATa8  
 Stimulus data of the selected trace, see [Table 11-20](#).  
 The data is transferred in the data format defined via `FORMat [ : DATA ]`.

**Example:**

```
SWE:POIN 20
Create a trace with 20 sweep points, making the created trace
the active trace of channel 1 (omitted optional mnemonic
SENSe1).
TRAC:STIM? CH1DATA
Query the 20 stimulus values of the created trace. In the default
format setting, the data is returned as a comma-separated list of
10-digit ASCII values.
```

**Usage:** Query only

## 11.6 VNA Programming Examples

This chapter contains detailed programming examples on various tasks.

The syntax and use of all SCPI commands is described in [Chapter 11, "Command Reference"](#), on page 520, where you will also find additional examples. For a general introduction to remote control of the analyzer refer to [Chapter 8, "Network and Remote Settings"](#), on page 149. For an overview of special remote control features of the VNA mode refer to [Chapter 11.4, "VNA Remote Control Basics"](#), on page 576.

### 11.6.1 Basic Tasks

This section presents detailed examples for programming tasks that almost every user will encounter when working with the R&S ZNL/ZNLE.

### 11.6.1.1 Typical Stages of a Remote Control Program

A typical remote control program comprises the following stages:

1. Performing the basic instrument settings
2. Adjusting the test setup
3. Initiating the measurement, command synchronization
4. Retrieving measurement results

Very often, steps 3 and 4 (or steps 2 to 4) must be repeated several times.



All example programs in this section have been developed and tested by means of the GPIB Explorer provided with the network analyzer. No extra programming environment is needed.

#### Basic Instrument Settings

**Programming task:** Adjust the basic network analyzer settings to your measurement tasks, optimizing the instrument for fast measurements.



#### Considerations for high measurement speed

The measurement speed depends on the sweep time but also on an efficient preparation of the instrument and on proper command synchronization. The following items should be kept in mind:

- For maximum speed the basic channel settings should be set while the sweep is stopped and with a minimum of sweep points. It is advisable to increase the number of points after all instrument settings have been performed, and to initiate the sweep after the test setup has been completed.
- Execution of the `INITiate[:IMMEDIATE]` command is fastest in synchronized mode. Insertion of fixed waiting periods into the command sequence is possible but generally less efficient.
- The sweep time depends on several parameters; see below. In particular it is recommended to select the best set of sweep points, e.g. using the segmented sweep.

```
// Reset the instrument, switch off the measurement (after one sweep),
// reduce the number of sweep points.
*RST
INITiate1:CONTinuous OFF
SENSe1:SWEep:POINts 2
//
// Avoid a delay time between different partial measurements and before the
// start of the sweeps (is default setting).
SENSe1:SWEep:TIME:AUTO ON
TRIGger1:SEQUence:SOURce IMMEDIATE
```

```
//
// Select the widest bandwidth compatible with your measurement.
SENSE1:BANDwidth:RESolution 10
//
// Adjust your sweep points to your measurement task, e.g. using a segmented sweep.
SENSE1:SEGment...
```

### Adjusting the Test Setup

In general the preparatives described above can be used for a series of measurements. In-between the measurements it is often necessary to change the test setup, e.g. to replace the DUT, change the connected ports, connect external devices etc.

### Start of the Measurement and Command Synchronization

Programming task: Start a measurement in single sweep mode. Wait until all single sweep data has been acquired before you proceed to the next stage of the measurement.

INITiate<Ch>[:IMMEDIATE] [:DUMMY] OR INITiate<Ch>[:IMMEDIATE]:ALL are used to start a single sweep or a group of single sweeps. These commands have been implemented for overlapped execution. The advantage of overlapped commands is that they allow the program to do other tasks while being executed.

In the present example the sweep must be completed before measurement results can be retrieved. To prevent wrong results (e.g. a mix-up of results from consecutive sweeps) the controller must synchronize its operation to the execution of INITiate<Ch>[:IMMEDIATE]. IEEE 488.2 defines three common commands (\*WAI, \*OPC?, \*OPC) for synchronization.

#### // 1. Start single sweep, use \*WAI

```
// *WAI is the easiest method of synchronization. It has no effect when sent
// after sequential commands.
// If *WAI follows INITiate<Ch>[:IMMEDIATE]... (overlapped commands), the analyzer
// executes no further commands or queries until the sweep is terminated.
// *WAI does prevent the controller from sending other commands to the analyzer
// or other devices

// Start single sweep in channel no. 1, wait until the end of the sweep
INITiate1:IMMEDIATE; *WAI
<Continue program sequence>
```

#### // 2. Start single sweep, use \*OPC?

```
// If *OPC follows INITiate<Ch>[:IMMEDIATE]..., it places a 1 into the
// output queue when the sweep is terminated.
// An appropriate condition in the remote control program must cause the
// controller to wait until *OPC? returns one.
// The controller is stopped from the moment when the condition is set.

// Start single sweep in channel no. 1, indicate the end of the sweep
```

```
// by a 1 in the output queue.
INITiate1:IMMEDIATE; *OPC?
// So far the controller may still send messages to other connected devices.

// Stop the controller until *OPC? returns one (program syntax depends
// on your programming environment).
<Condition OPC=1>
<Continue program sequence>
```

### // 3. Start single sweep, use \*OPC

```
// If *OPC follows INITiate<Ch>[:IMMEDIATE]..., it sets the OPC bit in the ESR
// after the sweep is terminated.
// This event can be polled or used to trigger a service request of the analyzer.
// The advantage of *OPC synchronization is that both the controller and the
// analyzer can continue processing commands while the sweep is in progress.

// Enable a service request for the ESR
*SRE 32
// Set event enable bit for operation complete bit
*ESE 1
// Start single sweep in channel no. 1, set the OPC bit in the ESR
// after the sweep is terminated.
// The controller may still send messages, the analyzer continues to parse
// and execute commands.
INITiate1:IMMEDIATE; *OPC

// Controller waits for service request from the analyzer
// (program syntax depends on your programming environment).
<Wait for service request>
<Continue program sequence>
```

## Retrieving Measurement Results

**Programming task:** Read the results acquired in a single sweep.

### // 1. Read single values (-> Markers)

```
// Markers are the most convenient tool for determining and retrieving single
// values on traces.
// The analyzer provides up to ten markers; see Markers and Limit Lines.
```

### // 2. Read complete trace

```
// Select a trace format and read formatted trace data.
CALCulate1:FORMat MLINear / Calculate the linear magnitude of z
CALCulate1:DATA? FDATA / Read the formatted trace data
```



Use `CALCulate<Chn>:DATA:NSweep:FIRST?` to retrieve a particular trace within a group of sweeps.



### 11.6.1.2 Channel, Trace and Diagram Handling

The following examples show you how to perform basic tasks related to channel and trace definition and to the display of traces in diagrams.



All example programs in this section have been developed and tested by means of the GPIB Explorer provided with the network analyzer. No extra programming environment is needed.

#### Several Traces with Equal Channel Settings

**Programming task:** Create up to four different traces with equal channel settings, assign the four 2-port standard S-parameters to the traces and display them in up to four diagrams.

#### Important remote control features for this program example

The following command sequence illustrates the structure of the remote commands discussed in section Basic Remote Control Concepts. In particular it shows that:

- A trace can be created and handled without being displayed.
- Traces are referenced by trace names. The active trace of a channel is often referenced by the channel suffix.
- Diagrams are referenced by a window suffix <Wnd>. An additional suffix <WndTr> in the DISPLAY:WINDOW<Wnd>:TRACE<WndTr>... commands numbers the different traces in a diagram.
- In remote control, it is possible to display the same trace in several diagrams.
- The analyzer provides several commands allowing a smooth transition between remote and manual control.

#### // 1. One channel, two traces, one diagram

```
// Reset the instrument, creating the default trace Trc1 in channel 1.
// The default measured quantity is the forward transmission S-parameter S21.
// The default format is dB Mag.
*RST

// Create a second trace in channel 1, assign the format Phase,
// and display the new trace in the same diagram.
// the trace becomes the active trace but is not displayed
CALCulatel:PARAMeter:SDEFine 'Trc2', 'S21'

// the trace is referenced by the channel suffix 1
CALCulatel:FORMat PHASE

// display the second trace, numbering it the second trace in diagram no. 1
DISPlay:WINDow1:TRACe2:FEED 'Trc2'
```

**// Check the result on the local screen**

```
// Go to local
SYSTem:DISPlay:UPDate ONCE
```

**// 2. One channel, two traces, two diagrams**

```
// Create a second diagram, assign Trc2 to the new area, and remove it
// from the first area.
DISPlay:WINDow2:STATe ON
DISPlay:WINDow2:TRACe2:FEED 'Trc2'
// Trc2 is now displayed in both diagrams
DISPlay:WINDow1:TRACe2:DELeTe
```

**// Check the result on the local screen**

```
// Go to local
SYSTem:DISPlay:UPDate ONCE
```

**// 3. One channel, four traces, four diagrams**

```
// Reset the instrument, add diagrams no. 2, 3, 4.
*RST; :DISPlay:WINDow2:STATe ON
DISPlay:WINDow3:STATe ON
DISPlay:WINDow4:STATe ON

// Assign the reflection parameter S11 to the default trace.
:CALCulatel:PARAmeter:MEASure 'Trc1', 'S11'

// Assign the remaining S-parameters to new traces Trc2, Trc3, Tr4;
// select the Smith chart format for the reflection parameters.
CALCulatel:FORMat SMITH // Smith chart for the active trace Trc1
CALCulatel:PARAmeter:SDEFine 'Trc2', 'S21'
CALCulatel:PARAmeter:SDEFine 'Trc3', 'S12'
CALCulatel:PARAmeter:SDEFine 'Trc4', 'S22'
// Smith chart for the active trace Trc4, referenced by the channel number
CALCulatel:FORMat SMITH

// Display the new traces in diagrams no. 2 to 4.
DISPlay:WINDow2:TRACe2:FEED 'Trc2'
DISPlay:WINDow3:TRACe3:FEED 'Trc3'
DISPlay:WINDow4:TRACe4:FEED 'Trc4'
```

**// Check the result on the local screen**

```
// Go to local
SYSTem:DISPlay:UPDate ONCE
```

**Several Traces with Different Channel Settings...**

**Programming task:** Create three channels with 3, 1 and 2 traces, respectively, and display the traces in two diagrams.

### Important remote control features for this program example

The following command sequence illustrates the structure of the remote commands discussed in section Basic Remote Control Concepts. In particular it shows that:

1. Channels are always referenced by a channel suffix.
2. Traces are referenced by trace names. The active trace of a channel is often referenced by the channel suffix.
3. Diagrams are referenced by a window suffix <Wnd>. An additional suffix <WndTr> in the DISPLAY:WINDOW<Wnd>:TRACE<WndTr>... commands numbers the different traces in a diagram.
4. The analyzer provides several commands allowing a smooth transition between remote and manual control.

#### // 1. Create all channels and traces

```
// Reset the instrument, creating the default trace Trc1 in channel 1.
// The default measured quantity is the forward transmission S-parameter S21.
// The default format is dB Mag.
*RST

// Create two more traces in channel 1, assigning a trace name and a measured
// quantity to each of them. Choose descriptive trace names (instead of the
// short default names used above).
CALCulate1:PARAmeter:SDEFine 'Impedance_trace', 'Z-S21'
// the trace becomes the active trace for channel 1 but is not displayed

CALCulate1:PARAmeter:SDEFine 'Admittance_trace', 'Y-S21'
// the trace becomes the active trace for channel 1

// Create channel 2 with one new trace, channel 3 with two new traces.
CALCulate2:PARAmeter:SDEFine 'Ratio_trace', 'B1/B2'
CALCulate3:PARAmeter:SDEFine 'Z_trace', 'Z21'
CALCulate3:PARAmeter:SDEFine 'Y_trace', 'Y21'
CALCulate3:PARAmeter:SElect 'Z_trace'
// the trace created previously becomes the active trace for channel 3
// So far, only the default trace is displayed.
```

#### // Check the result on the local screen

```
// Go to local
SYSTEM:DISPLAY:UPDATE ONCE
```

#### // 2. Create second diagram and display traces

```
DISPLAY:WINDOW2:STATE ON
DISPLAY:WINDOW1:TRACE2:FEED 'Admittance_trace'
DISPLAY:WINDOW1:TRACE3:FEED 'Y_trace'
DISPLAY:WINDOW2:TRACE1:FEED 'Impedance_trace'
```

```
DISPlay:WINDow2:TRACe2:FEED 'Ratio_trace'
DISPlay:WINDow2:TRACe3:FEED 'Z_trace'
```

### // Check the result on the local screen

```
// Go to local
SYSTem:DISPlay:UPDate ONCE
```

### // 3. Check and modify your configuration

```
// Query the traces in channel 1.
CALCulate1:PARAmeter:CATalog?
// The response is 'Trc1,S21,Impedance_trace,Z-S21,Admittance_trace,Y-S21'

// Query the reference level for the 'Z_trace'.
// The trace is referenced by its number in diagram no. 2.
DISPlay:WINDow2:TRACe3:Y:RLEVel?

// Change the display format for the 'Z_trace'. The trace is the active trace
// in channel 3, so it is referenced by the channel suffix 3.
// Update the display
CALCulate3:FORMat PHASe
// Update the display
SYSTem:DISPlay:UPDate ONCE
```

### Markers and Limit Lines...

**Programming task:** Display two traces in a single diagram area, use markers to read results, and perform a limit check.

### Important remote control features for this program example

The following command sequence illustrates the structure of the remote commands discussed in section Basic Remote Control Concepts. In particular it shows that:

1. Traces are referenced by trace names. The active trace of a channel is often referenced by the channel suffix. This simplifies the program syntax, e.g. in the commands for marker settings and for the limit check.
2. Diagrams are referenced by a window suffix <Wnd>. An additional suffix <WndTr> in the DISPlay:WINDow<Wnd>:TRACe<WndTr>... commands numbers the different traces in a diagram.
3. The analyzer provides several commands allowing a smooth transition between remote and manual control.

### // 1. Create one channel, two traces, one diagram

```
// Reset the instrument, creating the default trace Trc1 in channel 1.
// The default measured quantity is the forward transmission S-parameter S21.
// The default format is dB Mag.
*RST
```

```
// Create a second trace in channel 1, assign the format Phase,
// and display the new trace in the same diagram.

// the trace becomes the active trace but is not displayed
CALCulatel:PARAmeter:SDEFine 'Trc2', 'S21'

// the trace is referenced by the channel suffix 1
CALCulatel:FORMat PHASE

// display the second trace, numbering it the second trace in diagram no. 1
DISPlay:WINDow1:TRACe2:FEED 'Trc2'
```

### // Check the result on the local screen

```
// Go to local
SYSTem:DISPlay:UPDate ONCE
```

### // 2. Marker settings

```
// Adjust the sweep range to consider an interesting segment of the trace and
// re-scale the diagram.
SENSEl:FREQuency:STARt 4.5 GHz; STOP 5.5 GHz
// in the autoscale command the trace is referenced by its number in the diagram
DISPlay:WINDow1:TRACe1:Y:SCALE:AUTO ONCE

// Select trace Trc1 as the active trace of the channel, define a reference
// marker and a delta marker.
// In the marker commands the active trace is referenced by the channel suffix.
CALCulatel:PARAmeter:SElect 'Trc1'

// the marker is set to the center of the sweep range
CALCulatel:MARKer1:STATe ON

// this command also creates the reference marker
CALCulatel:MARKer1:DELTA:STATe ON

// set the reference marker to the beginning of the sweep range
CALCulatel:MARKer1:REFerence:X 4.5 GHz

// Use the delta marker to search for the minimum of the trace and query the result.
// the query returns the stimulus and the response value at the marker position
CALCulatel:MARKer1:FUNCTion:EXECute MIN; RES?
```

### // Check the result on the local screen

```
// Go to local
SYSTem:DISPlay:UPDate ONCE
```



Use the `CALCulate<Chn>:DATA...` commands to retrieve the complete trace; see [Retrieving Measurement Results](#).

**// 3. Limit lines and limit check**

```
// Remove all markers and define a limit line for the active trace.
CALCulate1:MARKer1:AOff
// define an upper limit line across the entire sweep range
CALCulate1:LIMit:DATA 1, 4500000000, 5500000000, -5, -5
CALCulate1:LIMit:DATA 2, 4500000000, 5000000000, -10, -15
// define two segments for the lower limit line
CALCulate1:LIMit:DATA 2, 5000000000, 5500000000, -15, -10

// Display the limit line and perform the limit check.
CALCulate1:LIMit:DISPlay:STATe ON
CALCulate1:LIMit:STATe ON; FAIL?
// if the trace failed the limit check; the response is 1
```

**// Check the result on the local screen**

```
// Go to local
SYSTem:DISPlay:UPDate ONCE
```

**11.6.2 Condensed Programming Examples**

This section contains short program examples for select issues. The comments have been commented in concise style; for more detailed information on the commands refer to [Chapter 11.5.2, "SCPI Command Reference"](#), on page 597.

If the example you are looking for is not in this section, we suggest you to refer to the short command sequences in the reference chapter. Proceed as follows:

1. Find your subject in the help system, preferably using context-sensitivity (of the help system on your network analyzer) or the index:

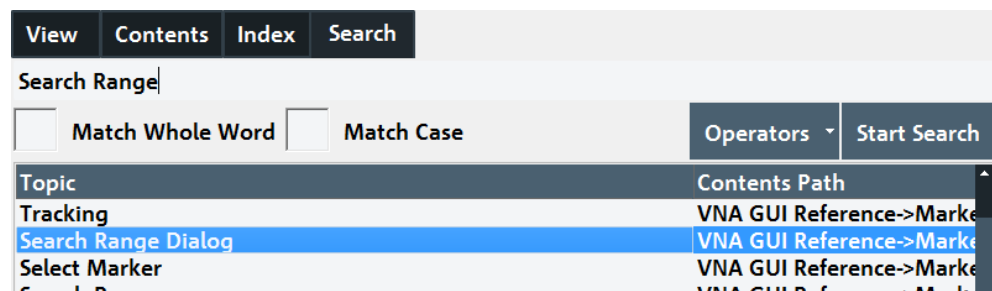

2. Activate the link to the command description:

Remote command:

```
CALCulate<Chn>:MARKer<Mk>:FUNction:DOMain:USER:RANGel
CALCulate<Chn>:MARKer<Mk>:FUNction:DOMain:USER:START
CALCulate<Chn>:MARKer<Mk>:FUNction:DOMain:USER:STOP
```

3. A short example appears at the end of each command description:

```

Example: CALC1:MARK1:FUNC:DOM:USER 2
 Select the search range no. 2, assigned to marker no. 1 and trace no. 1.
 CALC:MARK:FUNC:DOM:USER:START 1GHz
 Set the start frequency of the search range to 1 GHz.
 CALC:MARK:FUNC:DOM:USER:STOP 1.2GHz
 Set the stop frequency of the search range to 1.2 GHz.

```

### 11.6.2.1 Path Independent RC Programs

The default directory for R&S ZNL/ZNLE user data is

C:\Users\Public\Documents\Rohde-Schwarz\ZNL. Other instruments may use different default directories. To make remote control programs compatible, it is recommended to define all paths relative to the default directory, to be set via `MMEemory:CDIRectory DEFault`.

#### // Select default directory, change to sub-directory (relative to default directory)

```

MMEemory:CDIRectory DEFault
MMEemory:CDIRectory 'Traces'

MMEemory:STORE:TRACe 'Trc1', 'S21.s1p'
MMEemory:LOAD:TRACe 'Trc1', 'S21.s1p'

```

#### // Alternative, more compact definition

```

MMEemory:CDIRectory DEFault
MMEemory:STORE:TRACe 'Trc1', 'Traces\S21.s1p'

```

You may also read the default path (`MMEemory:CDIRectory?`) and use the external RC program to build the complete paths.

### 11.6.2.2 Trace and Diagram Handling

The following sections provide examples for efficient channel and trace definition and convenient diagram handling.

#### Assigning Channels, Traces, and Diagrams

The following example is a short version of [Chapter 11.6.1.2, "Channel, Trace and Diagram Handling"](#), on page 961.

#### // Reset the analyzer

```
*RST
```

#### // Create a new trace for S21 with the name TrcDisp

```

:CALCULATE1:PARAMETER:SDEFINE "TrcDisp","S21"
// Display the trace in the display area 1
:DISPLAY:WINDOW1:TRACE9:FEED 'TrcDisp'
:DISPLAY:WINDOW1:TRACE9:DELETE

```

**// List the traces, assigned to a certain Channel**

```
// format "<trace name>,<meas param>[,<trace name>,<meas param>...]"
:CALCULATE1:PARAMETER:CATALOG?
```

**// Channel 4 does not exist, a new channel and trace is created**

```
:CALCULATE4:PARAMETER:SDEFINE "Ch4Trc2","S22"
:CALCULATE4:PARAMETER:SDEFINE "Ch4Trc3","S33"
:CALCULATE4:PARAMETER:CATALOG?
```

**// Select active traces for channel 4**

```
:CALCULATE4:PARAMETER:SELECT "Ch4Trc2"
:CALCULATE4:PARAMETER:SELECT?
//:CALCULATE4:FORMAT POLAR
:CALCULATE4:PARAMETER:SELECT "Ch4Trc3"
//:CALCULATE4:FORMAT DB_LIN
:CALCULATE4:PARAMETER:SELECT?
:CALCULATE4:PARAMETER:SELECT "Ch4Trc2"
:CALCULATE4:FORMAT?
:CALCULATE4:PARAMETER:SELECT "Ch4Trc3"
:CALCULATE4:FORMAT?
```

**// Create trace**

```
:CALCULATE1:PARAMETER:SDEFINE "Trc2","S21"
:CALCULATE1:PARAMETER:SDEFINE "Trc3","S31"
:CALCULATE1:PARAMETER:CATALOG?
```

**// Delete trace**

```
:CALCULATE1:PARAMETER:DELETE "Trc2"
:CALCULATE1:PARAMETER:CATALOG?
```

**// Assign a trace to a window = diagram, diagram 1 always exists**

```
:DISPLAY:WINDOW1:TRACE2:FEED 'TrcDisp'
```

**// Create diagram 2**

```
:DISPLAY:WINDOW2:STATE?
:DISPLAY:WINDOW2:STATE ON
:DISPLAY:WINDOW2:STATE?
:DISPLAY:WINDOW2:TRACE6:FEED 'Ch4Trc2'
:DISPLAY:WINDOW2:TRACE2:FEED 'Trc1'
:DISPLAY:WINDOW2:TRACE3:FEED 'Ch4Trc3'
```

**// Create traces: trace names are not case-sensitive**

```
:CALCULATE4:PARAMETER:SELECT "Ch4Trc2"
:CALCULATE4:PARAMETER:SELECT?
:CALCULATE4:PARAMETER:SELECT "CH4TRC3"
```



```
:CALCULATE4:PARAMETER:SELECT?
:CALCULATE4:PARAMETER:SELECT "ch4trc2"
:CALCULATE4:PARAMETER:SELECT?
```

### Memory Traces

The following example shows how to save data to memory and work with memory traces.

#### // Reset the analyzer

```
*RST
:SENSE1:SWEEP:POINTS 20
```

#### // Create memory trace of the "active" trace (active for the parser !)

```
// the name of the created memory trace is "Mem2[Trc1]"
:TRACE:COPY MDATA2,CH1DATA
:SENSE1:FUNCTION:ON 'XFREQUENCY:POWER:S11'
:CALCULATE1:PARAMETER:CATALOG?

// Assign the memory trace to a window = diagram, diagram 1 always exists
:DISPLAY:WINDOW1:TRACE2:FEED 'Mem2[Trc1]'
```

#### // Create further memory traces and assign them to a window

```
:TRACE:COPY 'Mem3x[Trc1]',CH1DATA // mixed parameters String, Char
:DISPLAY:WINDOW1:TRACE3:FEED 'Mem3x[Trc1]'
:TRACE:COPY MDATA4,CH1DATA
:DISPLAY:WINDOW1:TRACE4:FEED 'Mem4[Trc1]'
```

#### // Create new normal trace on channel 1, assign it to a window

```
:CALCULATE1:PARAMETER:SDEFINE "Trc2","S22"
:DISPLAY:WINDOW1:TRACE5:FEED 'Trc2'
:CALCULATE1:PARAMETER:SELECT 'Trc2' // now active for channel 1
:CALCULATE1:PARAMETER:SELECT?
:CALCULATE1:PARAMETER:CATALOG?
```

#### // Create memory trace for 'Trc2',

```
// The memory trace can be assigned to the diagram of the mother trace only
// (diagram 1)
:TRACE:COPY MDATA6,CH1DATA
:DISPLAY:WINDOW1:TRACE6:FEED 'Mem6[Trc2]'
```

#### // Create new diagram 2 and new channel and trace

```
:DISPLAY:WINDOW2:STATE ON
:CALCULATE2:PARAMETER:SDEFINE "Ch2Trc1","S22"
:CALCULATE2:PARAMETER:SELECT 'Ch2Trc1' // now active for channel 2
:SENSE1:SWEEP:POINTS 21
```

```
:TRACE:COPY MDATA1,CH2DATA
:DISPLAY:WINDOW2:TRACE7:FEED 'Mem1[Ch2Trc1]'
:TRACE:DATA:STIMULUS? CH1DATA
:TRACE:DATA:RESPONSE? MDATA6
```

### // Create new channel 3 and new trace

```
:CALCULATE3:PARAMETER:SDEFINE "Ch3Trc1","S21"
:CALCULATE3:PARAMETER:SELECT 'Ch3Trc1' // now active for channel 3
:CALCULATE3:PARAMETER:SELECT? '%Ch3Trc1'
:SENSE1:SWEEP:POINTS 22
:TRACE:COPY MDATA8,CH3DATA
:TRACE:COPY MDATA7,CH3DATA
:DISPLAY:WINDOW2:TRACE1:FEED 'Mem8[Ch3Trc1]'
:TRACE:DATA:RESPONSE? MDATA7 // assigned to no diagram
```

### // Copy with arbitrary trace names, no blanks in trace names !!!

```
:TRACE:COPY 'Trace_Name','Ch3Trc1'
:DISPLAY:WINDOW2:TRACE2:FEED 'Trace_Name'
:CALCULATE3:PARAMETER:SELECT 'Trace_Name'
:CALCULATE3:PARAMETER:SELECT?
:TRACE:COPY 'XYZ','Ch2Trc1'
:DISPLAY:WINDOW2:TRACE3:FEED 'XYZ'
:CALCULATE2:PARAMETER:SELECT 'XYZ'
:CALCULATE2:PARAMETER:SELECT?
:TRACE:COPY MDATA4 , 'Ch3Trc1' // mixed parameters Char, String
:DISPLAY:WINDOW2:TRACE4:FEED 'Mem4[Ch3Trc1]'
```

### // Copy to existing memory traces = update trace data

```
:TRACE:COPY MDATA6,CH1DATA
:TRACE:COPY 'XYZ','Ch2Trc1'
:CALCULATE1:PARAMETER:CATALOG?
:CALCULATE2:PARAMETER:CATALOG?
:CALCULATE3:PARAMETER:CATALOG?
```

## Trace Mathematics

The following script shows how to define mathematical relations between traces.

### // Reset the analyzer

```
*RST
```

### // Create memory trace on active trace of channel 1,

```
// assign the memory trace to a diagram
:CALCULATE1:MATH:MEMORIZE
:DISPLAY:WINDOW1:TRACE2:FEED 'Mem2[Trc1]'
```

**// Define simple trace mathematics**

```
:CALCULATE1:MATH:FUNCTION ADD
:CALCULATE1:MATH:FUNCTION?
// Trace mathematics off
:CALCULATE1:MATH:FUNCTION NORMAL
:CALCULATE1:MATH:FUNCTION?
*RST
```

**// Create Trc2 in channel 1 and display it in diagram 1**

```
:CALCULATE1:PARAMETER:SDEFINE "Trc2","S11"
:DISPLAY:WINDOW1:TRACE2:FEED 'Trc2'
```

**// Create diagram 2 and Trc3 in new channel**

```
:DISPLAY:WINDOW2:STATE ON
:CALCULATE2:PARAMETER:SDEFINE "Trc3","S11"
:DISPLAY:WINDOW2:TRACE1:FEED 'Trc3'
```

**// Select active traces for channels 1 and 2**

```
:CALCULATE1:PARAMETER:SELECT "Trc1"
:CALCULATE2:PARAMETER:SELECT "Trc3"
```

**// Create memory trace on Trc1 and assign it to a diagram, same for TRC3**

```
:TRACE:COPY MDATA7,CH1DATA
:DISPLAY:WINDOW1:TRACE3:FEED 'Mem7[Trc1]'
:TRACE:COPY MDATA8,CH2DATA
:DISPLAY:WINDOW2:TRACE2:FEED 'Mem8[Trc3]'
```

**// Examples for Trace Mathematics**

```
// Special operands Data and Mem
:CALCULATE1:MATH:SDEFINE "Data * Mem"
:CALCULATE1:MATH:STATE ON
// Constants
:CALCULATE1:MATH:SDEFINE "Pi * e * j"
// Functions
:CALCULATE1:MATH:SDEFINE "linMag (1) + dBMag (2) + Arg (3) + Re (4) + Im (5j)"
:CALCULATE1:MATH:SDEFINE "log (2) * ln (3) * Min (1, 2) * Max (2, 3)"
:CALCULATE1:MATH:SDEFINE "StimVal + asin (sin (3)) + acos (cos (4))
+ atan (tan (4))"
:CALCULATE1:MATH:SDEFINE "(Trc1 + 2) * 1.1"
:CALCULATE1:MATH:SDEFINE "(tRC1 + e) * Pi + STIMVAL - sin (1) + Min (TRC1, Trc1)"
// Imaginary unit j = sqrt (-1)
// j is no ordinary operand: 1j not 1 * j
// magnitude: 1, phase: 60 degrees
:CALCULATE1:MATH:SDEFINE "(1 + 3 ^ (1 / 2) * 1j) / 2"
:CALCULATE1:MATH:SDEFINE "sin (1) + ACOS (0.5)"
// 2 periods for sin (), ... when stop frequency 8 GHz = 8e9 Hz
```

```

:CALCULATE1:MATH:SDEFINE "sin (2 * 2 * Pi * StimVal / 8e9) "
:CALCULATE1:MATH:SDEFINE "cos (2 * 2 * Pi * StimVal / 8e9) "
:CALCULATE1:MATH:SDEFINE "tan (2 * 2 * Pi * StimVal / 8e9) "
:CALCULATE1:MATH:SDEFINE "Min (sin (6 * Pi * StimVal / 8e9),
 cos (6 * Pi * StimVal / 8e9))"
:CALCULATE1:MATH:SDEFINE "Max (sin (6 * Pi * StimVal / 8e9),
 cos (6 * Pi * StimVal / 8e9))"
:CALCULATE1:MATH:SDEFINE "Trc1 ^ 2"
:CALCULATE1:MATH:SDEFINE "Trc1 + Trc2 + Trc3"
:CALCULATE1:MATH:SDEFINE "(Trc1 + e) * Pi + Mem8[Trc3] + StimVal
 + Min (Trc1, Mem7[Trc1])"
:CALCULATE1:MATH:SDEFINE "tan (5 * 2 * Pi * StimVal / 8e9)"

```

### Trace Statistics

The following script shows how to create a trace, select an evaluation range and retrieve statistical results.

#### // Reset the analyzer

```
*RST
```

#### // Create new channel and trace

```

:CALCULATE2:PARAMETER:SDEFINE 'Trc2', 'S11'
:CALCULATE2:PARAMETER:SELECT 'Trc2'
:DISPLAY:WINDOW2:STATE ON
:DISPLAY:WINDOW2:TRACE1:FEED 'Trc2'
:SENSE1:SWEEP:TIME:AUTO ON
:SENSE2:SWEEP:TIME:AUTO ON

```

#### // Search full-span evaluation range, display statistical results

```

:CALCulate1:STATistics:DOMain:USER 0
:CALCulate2:STATistics:DOMain:USER 0
:CALCULATE1:STATISTICS ON
:CALCULATE2:STATISTICS ON

```

#### // Single sweep, global scope

```

:INITIATE:CONTINUOUS OFF
:INITIATE:IMMEDIATE:SCOPE ALL
:SENSE:SWEEP:COUNT 4
:INITIATE:IMMEDIATE; *WAI

```

#### // Calculate statistical results (also possible if info field is switched off)

```

:CALCULATE1:STATISTICS:RESULT? MEAN
:CALCulate1:STATistics:RESult? ELENgth
:CALCULATE1:STATISTICS:RESULT? ALL

```

**// Modify evaluation range (is automatically confined to sweep range)**

```
:CALCulate1:STATistics:DOMain:USER 1
:CALCulate1:STATistics:DOMain:USER:START 0 HZ
:CALCulate1:STATistics:DOMain:USER:STOP 100 GHZ
:CALCulate1:STATISTICS:RESULT? MEAN

:CALCulate1:STATISTICS:RESULT? MAX
```

**Bandfilter Search**

The following example shows how to use markers for a bandpass or bandstop search.

**// Reset the analyzer**

```
*RST

:SENSe1:FREQuency:START 1 GHZ
:SENSe1:FREQuency:STOP 6 GHZ
```

**// Bandpass search ref. to max.**

```
:CALCulate1:MARKer:FUNCTion:BWIDth:MODE BPASs
:CALCulate1:MARKer:FUNCTion:BWIDth:MODE? %BPAS

// Measure single sweep, wait until complete sweep is finished
:INITiate:CONTinuous OFF
:INITiate; *WAI;
:CALCulate1:MARKer:FUNCTion:EXECute BFILter

// All markers OFF
:CALCulate1:MARKer:AOFF
```

**// Bandpass search ref. to marker**

```
:CALCulate1:MARKer1:STATe ON
:CALCulate1:MARKer1:X 3.0 GHz
:CALCulate1:MARKer:FUNCTion:BWIDth:MODE BPRMarker
:CALCulate1:MARKer:FUNCTion:BWIDth:MODE? %BPRM
:INITiate; *WAI;
:CALCulate1:MARKer:FUNCTion:EXECute BFILter
:CALCulate1:MARKer:AOFF
```

**// Bandstop search ref. to max.**

```
:CALCulate1:MARKer:FUNCTion:BWIDth:MODE BStOp
:CALCulate1:MARKer:FUNCTion:BWIDth:MODE? %BST
:INITiate; *WAI;
:CALCulate1:MARKer:FUNCTion:EXECute BFILter
:CALCulate1:MARKer:AOFF
```

**// Bandstop search ref. to marker**

```
:CALCulate1:MARKer1:STATe ON
:CALCulate1:MARKer1:X 1.7 GHz
```

```
:CALCulate1:MARKer:FUNCTION:BWIDth:MODE BsRMarker
:CALCulate1:MARKer:FUNCTION:BWIDth:MODE? %BsRM
:INITiate; *WAI;
:CALCulate1:MARKer:FUNCTION:EXECute BFILter
```

### Creating Diagrams

In the following example, remote control commands are used to position several diagrams on the screen. The remote control commands presented here extend the functionality of the "Display > Diagram" and "Display > Split" softtool tabs.

#### // Reset the analyzer

```
*RST
```

#### // Define and display a simple horizontal layout (two diagrams side by side)

```
:DISPlay:LAYout:DEFine 1, Horizontal, '1.00,0.30,0.70'
:DISPlay:LAYout:APPLY 1
```

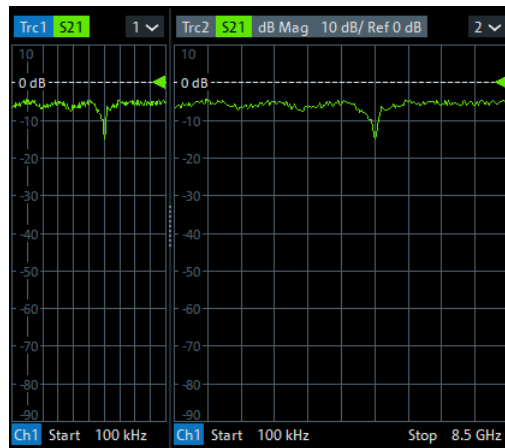

#### // Define and display a simple vertical layout (two diagrams, one on top of the other)

```
:DISPlay:LAYout:DEFine 2, Vertical, '1.00,0.50,0.50'
:DISPlay:LAYout:APPLY 2
```

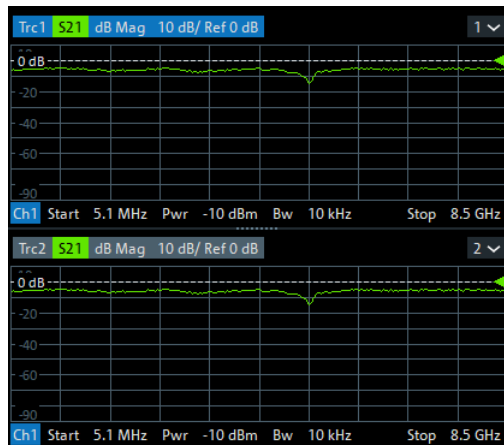

### // Check the executable formats of the generated layouts

```
:DISPlay:LAYout:DEFine? 1 %(1,1,0.00,0.00,(1,2,1.00,1.00,[0.30,1.00],[0.70,1.00]))
:DISPlay:LAYout:DEFine? 2 %(1,1,0.00,0.00,(2,1,1.00,1.00,[1.00,0.50],[1.00,0.50]))
```

### // Join the 2 layouts, display the nested layout

```
:DISPlay:LAYout:JOIN 1,2,2
:DISPlay:LAYout:APPLy 1
```

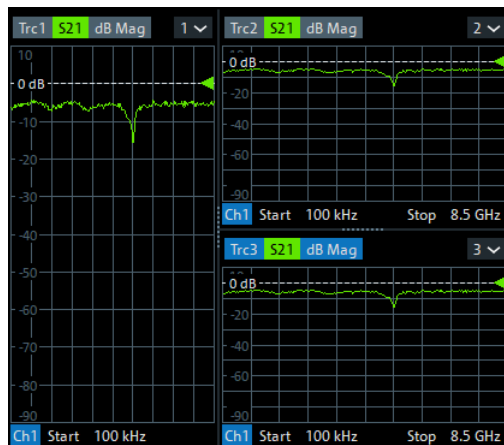

### // Check the last applied (i.e. the joined) layout for the correct format

```
:DISPlay:LAYout:EXECute?
 %(1,1,0.00,0.00,(1,2,1.00,1.00,[0.30,1.00],
 %(1,1,0.70,1.00,(2,1,1.00,1.00,[1.00,0.50],[1.00,0.50]))))
```

### // Set the layout format directly (horizontal, joined layout)

```
:DISPlay:LAYout:EXECute
 '(1,1,0.00,0.00,(1,2,1.00,1.00,[0.30,1.00],
 (1,1,0.70,1.00,(2,1,1.00,1.00,[1.00,0.50],[1.00,0.50])))'
```

**// Alternative direct definition of the joined layout as a vertical layout**

```
:DISPlay:LAYout:DEFine 3, VERT, '0.3,1.0;0.7,0.5,0.5'
:DISPlay:LAYout:APPLy 3
:DISPlay:LAYout:EXECute?
 %(1,2,0.00,0.00,(1,1,0.3,1.00,[1.00,1.0]),(2,1,0.7,1.00,[1.00,0.5],[1.00,0.5]))
```

**11.6.2.3 Using Markers**

The following example shows you how to define markers and use them to read trace values.

**// Reset the analyzer**

```
*RST
```

**// Initiate a single sweep**

```
:INITiate1:CONTinuous OFF
:INITiate1:IMMediate;*WAI

// The following marker commands have the channel no. as a numeric suffix.
// The parameter belongs to a trace, the assignment channel -> trace
// is done via a "active" trace for each channel
:CALCULATE1:PARAMETER:SELECT 'Trc1'
```

**// Marker ON / OFF**

```
:CALCULATE1:MARKER1 ON
:CALCULATE1:MARKER1:STATE?
```

**// Coupled Markers**

```
// All markers belonging to channels with the same sweep type
// (FREQUENCY, TIME, POWER, CW FREQUENCY) are coupled/decoupled
:CALCULATE1:MARKER:COUPLED ON
```

**// Marker Continuous / Discrete**

```
:CALCULATE1:MARKER1:MODE CONTINUOUS
```

**// Normal / Delta / Reference / Fixed Marker**

```
:CALCULATE1:MARKER:AOFF // all markers off
:CALCULATE1:MARKER1 ON
:CALCULATE1:MARKER1:X 1GHZ
:CALCULATE1:MARKER2 ON
:CALCULATE1:MARKER2:X 2GHZ
:CALCULATE1:MARKER3 ON
:CALCULATE1:MARKER3:X 3GHZ
:CALCULATE1:MARKER4:DELTA:STATE ON
:CALCULATE1:MARKER:REFERENCE ON
```



```
:CALCULATE1:MARKER:REFERENCE:X 5GHZ
:CALCULATE1:MARKER1:TYPE FIXED
```

### // Query marker response values

```
:CALCULATE1:FORMAT MLINEAR
:CALCULATE1:MARKER1 ON
:CALCULATE1:MARKER1:X DEF
:CALCULATE1:MARKER1:FORMAT MLINEAR
// DataBase EMarkerFormat::LIN_MAG
:CALCULATE1:MARKER1:Y?
:CALCULATE1:MARKER1:FORMAT MLOGARITHMIC
// DB_MAG
:CALCULATE1:MARKER1:Y?
```

## Marker Search Functions

The following example shows how to search for particular measurement points using markers.

### // Reset the analyzer

```
*RST
```

### // Define marker and stimulus range

```
:CALCULATE1:MARKER1 ON
:SENSE1:FREQUENCY:START 1GHZ
:SENSE1:FREQUENCY:STOP 2GHZ
// Do the marker search in the format DB Magnitude
:CALCULATE1:FORMAT MLOGARITHMIC
```

### // Define marker search ranges (stimulus range of the marker search)

```
// Range 0 is always the stimulus range of the trace (can't be changed)
:CALCULATE1:MARKER1:FUNCTION:DOMAIN:USER 0
:CALCULATE1:MARKER1:FUNCTION:DOMAIN:USER:START?
:CALCULATE1:MARKER1:FUNCTION:DOMAIN:USER:STOP?

// Range 1 (within the stimulus range)
:CALCULATE1:MARKER1:FUNCTION:DOMAIN:USER 1
:CALCULATE1:MARKER1:FUNCTION:DOMAIN:USER:START 1.2GHZ
:CALCULATE1:MARKER1:FUNCTION:DOMAIN:USER:STOP 1.8GHZ

// Range 2 (includes the stimulus range)
:CALCULATE1:MARKER1:FUNCTION:DOMAIN:USER 2
:CALCULATE1:MARKER1:FUNCTION:DOMAIN:USER:START 0.8GHZ
:CALCULATE1:MARKER1:FUNCTION:DOMAIN:USER:STOP 2.2GHZ

// Use range 0 (stimulus range of the trace)
:CALCULATE1:MARKER1:FUNCTION:DOMAIN:USER 0
```

**// Select linear magnitude scale for diagram**

```
:CALCULATE1:FORMAT MLINEAR
```

**// Search for global minimum and maximum (MIN, MAX)**

```
// (initial marker value may be inside or outside the marker search range)
:CALCULATE1:MARKER1:X 1.5GHZ
:CALCULATE1:MARKER:MIN
:CALCULATE1:MARKER1:X?

:CALCULATE1:MARKER1:X 1.5GHZ
:CALCULATE1:MARKER:MAX
:CALCULATE1:MARKER1:X?
```

**// Minimum peak search functions**

```
:CALCULATE1:MARKER1:FUNCTION:SELECT MINIMUM
:CALCULATE1:MARKER1:FUNCTION:SELECT?
// NEXT PEAK
:CALCULATE1:MARKER1:X 1.5GHZ
:CALCULATE1:MARKER:SEARCH:NEXT
:CALCULATE1:MARKER1:X?
// PEAK RIGHT
:CALCULATE1:MARKER1:X 1.5GHZ
:CALCULATE1:MARKER:SEARCH:RIGHT
:CALCULATE1:MARKER1:X?
// PEAK LEFT
:CALCULATE1:MARKER1:X 1.5GHZ
:CALCULATE1:MARKER:SEARCH:LEFT
:CALCULATE1:MARKER1:X?
```

**// Maximum peak search functions**

```
:CALCULATE1:MARKER1:FUNCTION:SELECT MAXIMUM
// Proceed as for minimum search
```

**11.6.2.4 Data Handling**

The following sections provide examples for efficient sweep definition and data handling. Part of the functionality is not available in manual control.

**Single Sweep Mode**

The commands `CALCulate<Ch>:DATA:NSweep...? SDATa,` `<Trace_Hist_Count>` retrieve the results of any sweep within a previously defined single sweep group. This means that, in single sweep mode, you can first measure a specified number of sweeps (`SENSe<Ch>:SWEep:COUNT <sweeps>`) and then read any of the data traces acquired.

This feature has no equivalent in manual control where always the last data trace is displayed.

```

// Reset the analyzer
*RST

// Create a second and third channel with new diagrams and traces.
:CALCULATE2:PARAMETER:SDEFINE "Trc2","S11"
:CALCULATE2:PARAMETER:SELECT "Trc2"
:DISPLAY:WINDOW2:STATE ON
:DISPLAY:WINDOW2:TRACE1:FEED 'Trc2'

:CALCULATE3:PARAMETER:SDEFINE "Trc3","S11"
:CALCULATE3:PARAMETER:SELECT "Trc3"
:DISPLAY:WINDOW3:STATE ON
:DISPLAY:WINDOW3:TRACE1:FEED 'Trc3'

// Select sweep time for the channels.
:SENSE1:SWEEP:TIME 1 S
:SENSE2:SWEEP:TIME 1 S
:SENSE3:SWEEP:TIME 1 S

// Enable single sweep mode for all channels so that channel-specific
// sweep count settings are used
:INITIATE:CONTINUOUS:ALL OFF

// Select single sweep mode with channel-specific sweep count settings
// Set sweep counts and start measurement in all channels

:SENSE1:SWEEP:COUNT 1
:SENSE2:SWEEP:COUNT 2
:SENSE3:SWEEP:COUNT 3

:INITIATE1:IMMEDIATE; *WAI
:INITIATE2:IMMEDIATE; *WAI
:INITIATE3:IMMEDIATE; *WAI

// Select single sweep mode with global sweep count settings

:SENSE:SWEEP:COUNT:ALL 2

:INITIATE1:IMMEDIATE; *WAI
:INITIATE2:IMMEDIATE; *WAI
:INITIATE3:IMMEDIATE; *WAI

```

### Modeling a Max Hold Function

The following example shows you how to emulate a max hold function.

#### // Reset the analyzer

```
*RST
```

#### // Create a trace with the last extremum as memory trace.

```

:TRACE:COPY 'LastExtr', 'Trc1'

// Display this last extremum trace.
// Because it's a memory trace it must be displayed in the same diagram
// as the mother trace.

```

```
:DISPlay:WINDow1:TRACe2:FEED 'LastExtr'
:CALCulate1:MATH:SDEFine 'Max (Data, Mem)'
:CALCulate1:MATH:STATE ON
```

### // Single sweep mode

```
:INITIATE:CONTINUOUS OFF

// Do a single sweep and update trace with the current extremum.
// This is the last extremum for the next sweep
:INITIATE:IMMEDIATE; *WAI
:TRACe:COPI:MATH 'LastExtr', 'Trc1'

// Loop over these 2 commands
:INITIATE:IMMEDIATE; *WAI
:TRACe:COPI:MATH 'LastExtr', 'Trc1'
:INITIATE:IMMEDIATE; *WAI
:TRACe:COPI:MATH 'LastExtr', 'Trc1'
```

### // Continuous sweep mode

```
:INITIATE:CONTINUOUS ON
```

## Retrieving the Results of Previous Sweeps

The commands `CALCulate<Ch>:DATA:NSweep...? SDATA,` `<Trace_Hist_Count>` retrieve the results of any sweep within a previously defined single sweep group. This means that, in single sweep mode, you can first measure a specified number of sweeps (`SENSe<Ch>:SWEep:COUNT <sweeps>`) and then read any of the data traces acquired.

This feature has no equivalent in manual control where always the last data trace is displayed.

### // Reset the analyzer

```
*RST
```

### // Create a second channel with a second trace

```
:CALCULATE2:PARAMETER:SDEFINE "Trc2","S11"
:CALCULATE2:PARAMETER:SELECT "Trc2"
:DISPLAY:WINDOW2:STATE ON
:DISPLAY:WINDOW2:TRACE1:FEED 'Trc2'
```

### // Select active trace for the created channel 2. Adjust the number of sweep points.

```
:CALCULATE2:PARAMETER:SELECT "Trc2"
:SENSE1:SWEEP:POINTS 3
:SENSE2:SWEEP:POINTS 4
```

**// Set sweep time and sweep count for the channels**

(3 traces per single sweep in channel 1, 4 traces in channel 2)

```
:SENSE1:SWEEP:TIME 1 S
:SENSE2:SWEEP:TIME 1 S
:SENSE1:SWEEP:COUNT 3
:SENSE2:SWEEP:COUNT 4
```

**// 1st Alternative: Reverse reading with command synchronization**

Select single sweep mode and measure a single sweep group for channels no. 1 and 2

```
:INITIATE:CONTInuous:ALL OFF
:INITIATE:IMMEDIATE:ALL; *WAI
```

Read trace data (without history, i.e. the last trace acquired in each channel)

```
:CALCULATE1:DATA? SDATA
:CALCULATE2:DATA? SDATA
```

Read last and previous trace data in channels 1 and 2

```
:CALCULATE1:DATA:NSWEEP? SDATA, 1 // last trace data
:CALCULATE1:DATA:NSWEEP? SDATA, 3 // previous trace data
:CALCULATE2:DATA:NSWEEP? SDATA, 1 // last trace data
:CALCULATE2:DATA:NSWEEP? SDATA, 4 // previous trace data
```

**// 2nd Alternative: Forward reading (no command synchronization necessary)**

Select single sweep mode and measure a single sweep group for channels no. 1

```
:INITIATE1:CONTInuous OFF
:INITIATE1:IMMEDIATE
```

Read the first and the following trace data in channel 1

```
if (CALCULATE1:DATA:NSWEEP:COUNT? > 2)
:CALCULATE1:DATA:NSWEEP:FIRST? SDATA, 1 // first trace data
:CALCULATE1:DATA:NSWEEP:FIRST? SDATA, 3 // third trace data
```

**Exporting S-Parameters**

The calibration defines which S-Parameters are allowed to be exported to a Touchstone file. In the following example, a default (TOSM) calibration is created to make all S-Parameters available.

**// Reset the analyzer**

```
*RST

:SENSE1:CORRection:COLlect:MEthod:DEFine 'Test', TOSM, 1, 2, 3, 4
:SENSE1:CORRection:COLlect:SAVE:SElected:DEFault
```

**// Initiate a complete sweep**

```
:INITiate1:CONTinuous OFF; :INITiate:IMMediate;*WAI
:MMEMory:STORe:TRACe:PORTs 1, 'ParserTouchstonePorts.s1p', COMPlEx, 2
:MMEMory:STORe:TRACe:PORTs 1, 'ParserTouchstonePorts.s2p', COMPlEx, 3, 2
:MMEMory:STORe:TRACe:PORTs 1, 'ParserTouchstonePorts.s4p', COMPlEx, 1, 4, 3, 2
```

**11.6.2.5 Calibration**

The following programming examples are related to system error correction and power calibration.

**One and Two-Port Calibration**

The following example calibrates one or two analyzer ports.

**// Reset the analyzer**

```
*RST
```

**// Set cal kit as active kit for N50**

```
:SENSE:CORRECTION:CKIT:N50:SELECT 'ZV-Z121'
```

**// Select connectors for the ports**

```
:SENSE1:CORRECTION:COLLECT:CONNECTION1 N50MALE
:SENSE1:CORRECTION:COLLECT:CONNECTION2 N50MALE

// Don't save the cal standard measurements with apply cal, i.e. with the commands
// :SENSE1:CORRECTION:COLLECT:SAVE or
// :SENSE1:CORRECTION:COLLECT:SAVE:SELEcted
// Instead, use the global, channel-independent setting:
:SENSE:CORRECTION:COLLECT:ACQUIRE:RSAVE:DEFAULT OFF
```

**// Full one port = OSM**

```
// Select cal procedure
:SENSE1:CORRECTION:COLLECT:METHOd:DEFine 'Test SFK OSM 1', FOPORT, 1

// Measure Standards
:SENSE1:CORRECTION:COLLECT:ACQUIRE:SELEcted OPEN, 1
:SENSE1:CORRECTION:COLLECT:ACQUIRE:SELEcted SHORT, 1
:SENSE1:CORRECTION:COLLECT:ACQUIRE:SELEcted MATCH, 1

// Apply cal
:SENSE1:CORRECTION:COLLECT:SAVE:SELEcted
```

**// 2 port TOSM**

```
// Select cal procedure
:SENSE1:CORRECTION:COLLECT:METHOd:DEFine 'Test SFK TOSM 12', TOSM, 1, 2
```

```
// Measure Standards
:SENSE1:CORRECTION:COLLECT:ACQUIRE:SELECTED THROUGH, 1, 2
:SENSE1:CORRECTION:COLLECT:ACQUIRE:SELECTED OPEN, 1
:SENSE1:CORRECTION:COLLECT:ACQUIRE:SELECTED SHORT, 1
:SENSE1:CORRECTION:COLLECT:ACQUIRE:SELECTED MATCH, 1
:SENSE1:CORRECTION:COLLECT:ACQUIRE:SELECTED OPEN, 2
:SENSE1:CORRECTION:COLLECT:ACQUIRE:SELECTED SHORT, 2
:SENSE1:CORRECTION:COLLECT:ACQUIRE:SELECTED MATCH, 2

// Apply calibration
:SENSE1:CORRECTION:COLLECT:SAVE:SELECTED
```

### // Save / load cal files

```
// Save calibration in calibration file pool
```

### // the filename in the commands must not contain the path !

```
:MEMORY:STORE:CORRECTION 1, 'OSM1 TOSM12.cal'

// load cal file from calibration file pool
:MEMORY:LOAD:CORRECTION 1, 'OSM1 TOSM12.cal'
```

## Saving and Recalling Error Terms

The following examples show you how to perform a system error correction, save the acquired system error correction data to a file and reload them.

### Performing a Calibration, Saving the Error Terms

#### // Reset the analyzer

```
*RST
```

#### // Set frequency range

```
:SENSE1:FREQUENCY1:START 1GHz
:SENSE1:FREQUENCY1:STOP 4GHz
:SENSE1:SWEPT:POINTS 6
```

#### // Select calibration type: TOSM at ports 1 and 2

```
:SENSE1:CORRECTION:COLLECT:METHOD:DEFINE 'Test SFK TOSM 12', TOSM, 1, 2

// Measure Standards
:SENSE1:CORRECTION:COLLECT:ACQUIRE:SELECTED THROUGH, 1, 2
:SENSE1:CORRECTION:COLLECT:ACQUIRE:SELECTED OPEN, 1
:SENSE1:CORRECTION:COLLECT:ACQUIRE:SELECTED SHORT, 1
:SENSE1:CORRECTION:COLLECT:ACQUIRE:SELECTED MATCH, 1
:SENSE1:CORRECTION:COLLECT:ACQUIRE:SELECTED OPEN, 2
:SENSE1:CORRECTION:COLLECT:ACQUIRE:SELECTED SHORT, 2
:SENSE1:CORRECTION:COLLECT:ACQUIRE:SELECTED MATCH, 2
```

**// Apply calibration**

```
SENSE1:CORREction:COLlect:SAVE:SElected
```

**// Save error terms**

```
:FORMAT REAL, 32
@TRACEFILE:scorr1.dat
:CALCulate1:DATA? SCORr1
@TRACEFILE:scorr2.dat
:CALCulate1:DATA? SCORr2
@TRACEFILE:scorr3.dat
:CALCulate1:DATA? SCORr3
// We are omitting the isolation term, as it is not implemented
// @TRACEFILE:scorr4.dat
// :CALCulate1:DATA? SCORr4
@TRACEFILE:scorr5.dat
:CALCulate1:DATA? SCORr5
@TRACEFILE:scorr6.dat
:CALCulate1:DATA? SCORr6
@TRACEFILE:scorr7.dat
:CALCulate1:DATA? SCORr7
@TRACEFILE:scorr8.dat
:CALCulate1:DATA? SCORr8
@TRACEFILE:scorr9.dat
:CALCulate1:DATA? SCORr9
// We are omitting the isolation term, as it is not implemented
// @TRACEFILE:scorr10.dat
// :CALCulate1:DATA? SCORr10
@TRACEFILE:scorr11.dat
:CALCulate1:DATA? SCORr11
@TRACEFILE:scorr12.dat
:CALCulate1:DATA? SCORr1
```

**Performing a New Calibration, Recalling the Error Terms****// Reset the analyzer**

```
*RST
```

**// Set frequency range**

```
:SENSE1:FREQuency1:STARt 1GHz
:SENSE1:FREQuency1:STOP 4GHz
:SENSE1:SWEep:POINts 6
```

**// Select calibration type: TOSM at ports 1 and 2**

```
:SENSE1:CORREction:COLlect:MEthod:DEFine 'XYZ', TOSM, 1, 2
```



**// Generate a set of default correction data, switch on user calibration**

```

:SENSe1:CORRection:COLlect:SAVE:SElected:DEfault
SENSE1:CORRECTION:STATE ON

// In the previous section, the following error terms were saved:
// SCORR1 Forward Directivity
// SCORR2 Forward Source Match
// SCORR3 Forward Reflection Tracking
// SCORR4 Forward Isolation
// SCORR5 Forward Load Match
// SCORR6 Forward Transmission Tracking
// SCORR7 Reverse Directivity
// SCORR8 Reverse Source Match
// SCORR9 Reverse Reflection Tracking
// SCORR10 Reverse Isolation
// SCORR11 Reverse Load Match
// SCORR12 Reverse Transmission Tracking

// Equivalences between the first parameter of CALculate:DATA
// and the first 3 Parameters of SENSe:CORRection:CDAta

// 'SCORR1' 'DIRECTIVITY', 1, 0 <Port 2> = 0 ignored
// 'SCORR2' 'SRCMATCH', 1, 0 <Port 2> = 0 ignored
// 'SCORR3' 'REFLTRACK', 1, 0 <Port 2> = 0 ignored
// 'SCORR4' 'ISOLATION', 1, 2
// 'SCORR5' 'LOADMATCH', 1, 2
// 'SCORR6' 'TRANSTRACK', 1, 2
// 'SCORR7' 'DIRECTIVITY', 2, 0 <Port 2> = 0 ignored
// 'SCORR8' 'SRCMATCH', 2, 0 <Port 2> = 0 ignored
// 'SCORR9' 'REFLTRACK', 2, 0 <Port 2> = 0 ignored
// 'SCORR10' 'ISOLATION', 2, 1
// 'SCORR11' 'LOADMATCH', 2, 1
// 'SCORR12' 'TRANSTRACK', 2, 1

```

**// Set format for data transfer**

```
:FORMAT REAL,32
```

**// !!! Important !!! Stop sweep when loading error terms**

```
:INITiate:CONTinuous OFF
```

**// Recall error terms**

```

// CALCulate:DATA is suitable for 2-port terms;
// use SENSe:CORRection:CDAta for more than 2 ports
:CALCulate1:DATA SCORR1,#@scorr1.dat
:CALCulate1:DATA SCORR2,#@scorr2.dat
:CALCulate1:DATA SCORR3,#@scorr3.dat
// We are omitting the isolation term, as it is not implemented on the ZVAB
//:CALCulate1:DATA SCORR4,#@scorr4.dat
:CALCulate1:DATA SCORR5,#@scorr5.dat

```

```

:CALCulate1:DATA SCORR6,#@scorr6.dat
:CALCulate1:DATA SCORR7,#@scorr7.dat
:CALCulate1:DATA SCORR8,#@scorr8.dat
:CALCulate1:DATA SCORR9,#@scorr9.dat
// We are omitting the isolation term, as it is not implemented on the ZVAB
//:CALCulate1:DATA SCORR10,#@scorr10.dat
:CALCulate1:DATA SCORR11,#@scorr11.dat
:CALCulate1:DATA SCORR12,#@scorr12.dat

:INITiate:CONTinuous ON

```

### Using a Calibration Data Recorded Previously

You can reuse any set of correction data that you acquired in earlier sessions on your analyzer. In general you have to carry out the following steps:

1. Create a dummy correction data set and store it to a file.
2. Replace the dummy data with your correction data.
3. Reimport the correction data file and apply it to a channel.

See also the program example for

[SENSE<Ch>:]CORREction:COLLECT:SAVE:SELEcted:DEFault (dummy system error correction).

### Adapter Removal

#### // define calibration method

```
SENSE1:CORREction:COLLECT:METHOD:DEFine 'Parser Test SFK', ARTosm, 1, 2
```

#### // Start with Calkit-1 (e.g. 3.5 mm ideal Kit)

```

//adapter side port 1
SENSE1:CORRECTION:COLLECT:ACQUIRE:SELEcted OPEN, 1, ON
SENSE1:CORRECTION:COLLECT:ACQUIRE:SELEcted SHORT, 1, ON
SENSE1:CORRECTION:COLLECT:ACQUIRE:SELEcted MATCH, 1, ON

//non adapter side port 2
SENSE1:CORRECTION:COLLECT:ACQUIRE:SELEcted OPEN, 2, OFF
SENSE1:CORRECTION:COLLECT:ACQUIRE:SELEcted SHORT, 2, OFF
SENSE1:CORRECTION:COLLECT:ACQUIRE:SELEcted MATCH, 2, OFF

```

#### // continue with Calkit-1 (e.g. N 50 Ohm ideal Kit)

```

//adapter side port 2
SENSE1:CORRECTION:COLLECT:ACQUIRE:SELEcted OPEN, 2, ON
SENSE1:CORRECTION:COLLECT:ACQUIRE:SELEcted SHORT, 2, ON
SENSE1:CORRECTION:COLLECT:ACQUIRE:SELEcted MATCH, 2, ON

//non adapter side port 1

```

```
SENSE1:CORRECTION:COLLECT:ACQUIRE:SELEcted OPEN, 1, OFF
SENSE1:CORRECTION:COLLECT:ACQUIRE:SELEcted SHORT, 1, OFF
SENSE1:CORRECTION:COLLECT:ACQUIRE:SELEcted MATCH, 1, OFF
```

### // connect adapter between port 1 and 2

```
SENSE1:CORRECTION:COLLECT:ACQUIRE:SELEcted THROugh, 1, 2
```

### // save calibration

```
SENSE1:CORRection:COLLect:SAVE:SELEcted
```

## 11.7 List of commands

|                                                                   |     |
|-------------------------------------------------------------------|-----|
| [SENSe:]CORRection:CKIT:<ConnType>:LSElect.....                   | 833 |
| [SENSe:]CORRection:CKIT:<ConnType>:SElect.....                    | 826 |
| [SENSe:]CORRection:CKIT:<OnePortStandardType>:WLAbel:SDATa?.....  | 835 |
| [SENSe:]CORRection:CKIT:<StandardType>.....                       | 827 |
| [SENSe:]CORRection:CKIT:<StandardType>:WLAbel.....                | 834 |
| [SENSe:]CORRection:CKIT:<TwoPortStandard>:WLAbel:SDATa?.....      | 835 |
| [SENSe:]CORRection:CKIT:CATalog?.....                             | 823 |
| [SENSe:]CORRection:CKIT:DELeTe.....                               | 823 |
| [SENSe:]CORRection:CKIT:DMODE.....                                | 824 |
| [SENSe:]CORRection:CKIT:INSTall.....                              | 946 |
| [SENSe:]CORRection:CKIT:LABel.....                                | 824 |
| [SENSe:]CORRection:CKIT:LCATalog?.....                            | 831 |
| [SENSe:]CORRection:CKIT:LDELeTe.....                              | 831 |
| [SENSe:]CORRection:CKIT:LLAbel.....                               | 832 |
| [SENSe:]CORRection:CKIT:LSElect.....                              | 833 |
| [SENSe:]CORRection:CKIT:SElect.....                               | 825 |
| [SENSe:]CORRection:CKIT:STANdard:CATalog?.....                    | 825 |
| [SENSe:]CORRection:CKIT:STANdard:DATa?.....                       | 826 |
| [SENSe:]CORRection:CKIT:STANdard:LCATalog?.....                   | 833 |
| [SENSe:]CORRection:COLLect:AUTO:CKIT.....                         | 837 |
| [SENSe:]CORRection:COLLect:AUTO:CKIT:PASSword.....                | 838 |
| [SENSe:]CORRection:COLLect:AUTO:CKIT:PORTs.....                   | 839 |
| [SENSe:]CORRection:COLLect:AUTO:CKIT:PORTs:ADD.....               | 840 |
| [SENSe:]CORRection:COLLect:AUTO:PORTs:CONNectiOn?.....            | 840 |
| [SENSe:]CORRection:COLLect:AVERAge.....                           | 841 |
| [SENSe:]CORRection:COLLect:CHANnels:ALL.....                      | 841 |
| [SENSe:]CORRection:COLLect:CHANnels:MCTypes.....                  | 841 |
| [SENSe:]CORRection:COLLect:FIXTure:LMPParameter:LOSS[:STATe]..... | 843 |
| [SENSe:]CORRection:COLLect:FIXTure:LMPParameter[:STATe].....      | 843 |
| [SENSe:]CORRection:EDELay:VNETwork.....                           | 870 |
| [SENSe:]ROSCillator:SOURce.....                                   | 558 |
| [SENSe:]SWEep:COUNT:ALL.....                                      | 900 |
| [SENSe<Ch>:]AVERAge:CLEar.....                                    | 819 |
| [SENSe<Ch>:]AVERAge:COUNT.....                                    | 819 |
| [SENSe<Ch>:]AVERAge:MODE.....                                     | 819 |

|                                                            |     |
|------------------------------------------------------------|-----|
| [SENSe<Ch>:]AVERage[:STATe].....                           | 818 |
| [SENSe<Ch>:]BANDwidth[:RESolution].....                    | 820 |
| [SENSe<Ch>:]BANDwidth[:RESolution]:SElect.....             | 821 |
| [SENSe<Ch>:]BWIDth[:RESolution].....                       | 820 |
| [SENSe<Ch>:]BWIDth[:RESolution]:SElect.....                | 821 |
| [SENSe<Ch>:]CORRection:CDATa.....                          | 821 |
| [SENSe<Ch>:]CORRection:CKIT:<ConnType>:<StandardType>..... | 945 |
| [SENSe<Ch>:]CORRection:COLLect:AUTO.....                   | 845 |
| [SENSe<Ch>:]CORRection:COLLect:AUTO:CONFigure.....         | 846 |
| [SENSe<Ch>:]CORRection:COLLect:AUTO:PORTs.....             | 848 |
| [SENSe<Ch>:]CORRection:COLLect:AUTO:PORTs:TYPE.....        | 849 |
| [SENSe<Ch>:]CORRection:COLLect:AUTO:TYPE.....              | 850 |
| [SENSe<Ch>:]CORRection:COLLect:CKIT:INSTall.....           | 852 |
| [SENSe<Ch>:]CORRection:COLLect:CKIT:LOAD.....              | 852 |
| [SENSe<Ch>:]CORRection:COLLect:CKIT:PORT<PhyPt>?.....      | 852 |
| [SENSe<Ch>:]CORRection:COLLect:CONNect:GENDerS.....        | 854 |
| [SENSe<Ch>:]CORRection:COLLect:CONNect:PORTs.....          | 854 |
| [SENSe<Ch>:]CORRection:COLLect:CONNect<PhyPt>.....         | 853 |
| [SENSe<Ch>:]CORRection:COLLect:DELeTe.....                 | 855 |
| [SENSe<Ch>:]CORRection:COLLect:DISCrd.....                 | 855 |
| [SENSe<Ch>:]CORRection:COLLect:FIXTure:EXPort.....         | 857 |
| [SENSe<Ch>:]CORRection:COLLect:FIXTure:IMPort.....         | 857 |
| [SENSe<Ch>:]CORRection:COLLect:FIXTure:SAVE.....           | 858 |
| [SENSe<Ch>:]CORRection:COLLect:FIXTure:STARt.....          | 858 |
| [SENSe<Ch>:]CORRection:COLLect:FIXTure[:ACQuire].....      | 856 |
| [SENSe<Ch>:]CORRection:COLLect:LOAD:SELeCted.....          | 859 |
| [SENSe<Ch>:]CORRection:COLLect:METhod.....                 | 948 |
| [SENSe<Ch>:]CORRection:COLLect:METhod:DEFine.....          | 860 |
| [SENSe<Ch>:]CORRection:COLLect:SAVE:DEFault.....           | 948 |
| [SENSe<Ch>:]CORRection:COLLect:SAVE:SELeCted:DEFault.....  | 861 |
| [SENSe<Ch>:]CORRection:COLLect:SAVE:SELeCted[:DUMMy].....  | 862 |
| [SENSe<Ch>:]CORRection:COLLect:SAVE[:DUMMy].....           | 949 |
| [SENSe<Ch>:]CORRection:COLLect:SCONNect<PhyPt>.....        | 863 |
| [SENSe<Ch>:]CORRection:COLLect[:ACQuire].....              | 947 |
| [SENSe<Ch>:]CORRection:COLLect[:ACQuire]:SELeCted.....     | 844 |
| [SENSe<Ch>:]CORRection:CONNect.....                        | 864 |
| [SENSe<Ch>:]CORRection:CONNect:CATalog?.....               | 864 |
| [SENSe<Ch>:]CORRection:CONNect:DELeTe.....                 | 865 |
| [SENSe<Ch>:]CORRection:DATA.....                           | 950 |
| [SENSe<Ch>:]CORRection:DATA:PARAmeter:COUNT?.....          | 867 |
| [SENSe<Ch>:]CORRection:DATA:PARAmeter<Sfk>?.....           | 866 |
| [SENSe<Ch>:]CORRection:DATE?.....                          | 868 |
| [SENSe<Ch>:]CORRection:DELeTe.....                         | 861 |
| [SENSe<Ch>:]CORRection:EDELay:AUTO.....                    | 868 |
| [SENSe<Ch>:]CORRection:EDELay<PhyPt>:DIElectric.....       | 869 |
| [SENSe<Ch>:]CORRection:EDELay<PhyPt>:DISTance.....         | 869 |
| [SENSe<Ch>:]CORRection:EDELay<PhyPt>:ELEngth.....          | 869 |
| [SENSe<Ch>:]CORRection:EDELay<PhyPt>[:TIME].....           | 870 |
| [SENSe<Ch>:]CORRection:EWAVe[:STATe].....                  | 871 |
| [SENSe<Ch>:]CORRection:LOSS:AUTO.....                      | 871 |

|                                                                  |     |
|------------------------------------------------------------------|-----|
| [SENSe<Ch>:]CORRection:LOSS<PhyPt>.....                          | 871 |
| [SENSe<Ch>:]CORRection:LOSS<PhyPt>:FREQuency.....                | 872 |
| [SENSe<Ch>:]CORRection:LOSS<PhyPt>:OFFSet.....                   | 872 |
| [SENSe<Ch>:]CORRection:LOSS<PhyPt>:SECond.....                   | 871 |
| [SENSe<Ch>:]CORRection:LOSS<PhyPt>:SECond:FREQuency.....         | 872 |
| [SENSe<Ch>:]CORRection:LOSS<PhyPt>:SECond:STATe.....             | 872 |
| [SENSe<Ch>:]CORRection:OFFSet<PhyPt>:COMPensation[:STATe].....   | 873 |
| [SENSe<Ch>:]CORRection:OFFSet<PhyPt>:DFComp[:STATe]?.....        | 874 |
| [SENSe<Ch>:]CORRection:OFFSet<PhyPt>:MAGNitude.....              | 952 |
| [SENSe<Ch>:]CORRection:OFFSet<PhyPt>[:STATe].....                | 873 |
| [SENSe<Ch>:]CORRection:STIMulus?.....                            | 874 |
| [SENSe<Ch>:]CORRection[:STATe].....                              | 843 |
| [SENSe<Ch>:]COUPle.....                                          | 875 |
| [SENSe<Ch>:]FREQuency:CENTer.....                                | 877 |
| [SENSe<Ch>:]FREQuency:FIXed.....                                 | 876 |
| [SENSe<Ch>:]FREQuency:MODE.....                                  | 953 |
| [SENSe<Ch>:]FREQuency:SBANd.....                                 | 878 |
| [SENSe<Ch>:]FREQuency:SEGMENT:AXIS.....                          | 878 |
| [SENSe<Ch>:]FREQuency:SPAN.....                                  | 879 |
| [SENSe<Ch>:]FREQuency:START.....                                 | 879 |
| [SENSe<Ch>:]FREQuency:STOP.....                                  | 879 |
| [SENSe<Ch>:]FREQuency[:CW].....                                  | 876 |
| [SENSe<Ch>:]HARMonic:AUTO.....                                   | 880 |
| [SENSe<Ch>:]HARMonic?.....                                       | 880 |
| [SENSe<Ch>:]LPORT<LogPt>:ZCOMMon.....                            | 881 |
| [SENSe<Ch>:]LPORT<LogPt>:ZDEFault[:STATe].....                   | 882 |
| [SENSe<Ch>:]LPORT<LogPt>:ZDIFferent.....                         | 881 |
| [SENSe<Ch>:]PORT<PhyPt>:ZREFerence.....                          | 882 |
| [SENSe<Ch>:]POWer:ATTenuation.....                               | 883 |
| [SENSe<Ch>:]SEGMENT:COUNT?.....                                  | 884 |
| [SENSe<Ch>:]SEGMENT<Seg>:ADD.....                                | 885 |
| [SENSe<Ch>:]SEGMENT<Seg>:BWIDth[:RESolution].....                | 886 |
| [SENSe<Ch>:]SEGMENT<Seg>:BWIDth[:RESolution]:CONTrol.....        | 886 |
| [SENSe<Ch>:]SEGMENT<Seg>:BWIDth[:RESolution]:SElect.....         | 887 |
| [SENSe<Ch>:]SEGMENT<Seg>:BWIDth[:RESolution]:SElect:CONTrol..... | 887 |
| [SENSe<Ch>:]SEGMENT<Seg>:CLEar.....                              | 953 |
| [SENSe<Ch>:]SEGMENT<Seg>:DEFine.....                             | 888 |
| [SENSe<Ch>:]SEGMENT<Seg>:DEFine:SElect.....                      | 890 |
| [SENSe<Ch>:]SEGMENT<Seg>:DELeTe:ALL.....                         | 890 |
| [SENSe<Ch>:]SEGMENT<Seg>:DELeTe[:DUMMy].....                     | 891 |
| [SENSe<Ch>:]SEGMENT<Seg>:FREQuency:CENTer?.....                  | 891 |
| [SENSe<Ch>:]SEGMENT<Seg>:FREQuency:SPAN?.....                    | 891 |
| [SENSe<Ch>:]SEGMENT<Seg>:FREQuency:START.....                    | 892 |
| [SENSe<Ch>:]SEGMENT<Seg>:FREQuency:STOP.....                     | 892 |
| [SENSe<Ch>:]SEGMENT<Seg>:INSert.....                             | 892 |
| [SENSe<Ch>:]SEGMENT<Seg>:INSert:SElect.....                      | 894 |
| [SENSe<Ch>:]SEGMENT<Seg>:OVERlap.....                            | 953 |
| [SENSe<Ch>:]SEGMENT<Seg>:POWer[:LEVel].....                      | 895 |
| [SENSe<Ch>:]SEGMENT<Seg>:POWer[:LEVel]:CONTrol.....              | 895 |
| [SENSe<Ch>:]SEGMENT<Seg>:SWEep:DWELl.....                        | 896 |

|                                                   |     |
|---------------------------------------------------|-----|
| [SENSe<Ch>:]SEGMENT<Seg>:SWEep:DWELL:CONTRol..... | 897 |
| [SENSe<Ch>:]SEGMENT<Seg>:SWEep:POINts.....        | 897 |
| [SENSe<Ch>:]SEGMENT<Seg>:SWEep:TIME.....          | 898 |
| [SENSe<Ch>:]SEGMENT<Seg>:SWEep:TIME:CONTRol.....  | 899 |
| [SENSe<Ch>:]SEGMENT<Seg>:SWEep:TIME:SUM?.....     | 899 |
| [SENSe<Ch>:]SEGMENT<Seg>[:STATe].....             | 885 |
| [SENSe<Ch>:]SWEep:COUNT.....                      | 900 |
| [SENSe<Ch>:]SWEep:DWELL.....                      | 901 |
| [SENSe<Ch>:]SWEep:DWELL:IPOint.....               | 901 |
| [SENSe<Ch>:]SWEep:POINts.....                     | 902 |
| [SENSe<Ch>:]SWEep:SPACing.....                    | 954 |
| [SENSe<Ch>:]SWEep:STEP.....                       | 902 |
| [SENSe<Ch>:]SWEep:TIME.....                       | 903 |
| [SENSe<Ch>:]SWEep:TIME:AUTO.....                  | 904 |
| [SENSe<Ch>:]SWEep:TYPE.....                       | 905 |
| [SENSe<Chn>:]CORREction:SState?.....              | 875 |
| [SENSe<Chn>:]FUNCTioN[:ON].....                   | 954 |
| [SENSe<Chn>:]SWEep:SRCPort.....                   | 906 |
| *CAL?.....                                        | 521 |
| *CLS.....                                         | 521 |
| *ESE.....                                         | 521 |
| *ESR?.....                                        | 522 |
| *IDN?.....                                        | 522 |
| *IST?.....                                        | 522 |
| *OPC.....                                         | 522 |
| *OPT?.....                                        | 522 |
| *PCB.....                                         | 523 |
| *PRE.....                                         | 523 |
| *PSC.....                                         | 523 |
| *RST.....                                         | 523 |
| *SRE.....                                         | 524 |
| *STB?.....                                        | 524 |
| *TRG.....                                         | 524 |
| *TST?.....                                        | 524 |
| *WAI.....                                         | 524 |
| CALCulate:CLIMits:FAIL?.....                      | 597 |
| CALCulate:DATA:ALL?.....                          | 598 |
| CALCulate:DATA:DALL?.....                         | 599 |
| CALCulate:DATA:TRACe.....                         | 599 |
| CALCulate:FILTer[:GATE]:TIME:AOFFset.....         | 609 |
| CALCulate:LIMit:CIRClE:FAIL:ALL?.....             | 617 |
| CALCulate:LIMit:FAIL:ALL?.....                    | 617 |
| CALCulate:LIMit:FAIL:DATA?.....                   | 617 |
| CALCulate:MARKer:COUPled:TYPE.....                | 635 |
| CALCulate:MARKer:COUPled[:STATe].....             | 634 |
| CALCulate:MARKer:FUNCTioN:BWIDth:GMCenter.....    | 635 |
| CALCulate:PARAmeter:DELeTe:ALL.....               | 663 |
| CALCulate:PARAmeter:DELeTe:MEMory.....            | 663 |
| CALCulate:RIPlle:DISPlay:RESult:ALL[:STATe].....  | 672 |
| CALCulate:RIPlle:FAIL:ALL?.....                   | 672 |

|                                                                                          |     |
|------------------------------------------------------------------------------------------|-----|
| CALCulate:TDVSwr[:STATe].....                                                            | 686 |
| CALCulate<Ch>:DATA:CALL.....                                                             | 600 |
| CALCulate<Ch>:DATA:CALL:CATalog?.....                                                    | 601 |
| CALCulate<Ch>:DATA:CHANnel:ALL?.....                                                     | 601 |
| CALCulate<Ch>:DATA:CHANnel:DALL?.....                                                    | 601 |
| CALCulate<Ch>:DATA:MDATa:INTerpolate.....                                                | 602 |
| CALCulate<Ch>:DATA:SGRoup?.....                                                          | 602 |
| CALCulate<Ch>:PARAmeter:CATalog:SENDED?.....                                             | 664 |
| CALCulate<Ch>:PARAmeter:CATalog?.....                                                    | 664 |
| CALCulate<Ch>:PARAmeter:DEFine.....                                                      | 938 |
| CALCulate<Ch>:PARAmeter:DEFine:SGRoup.....                                               | 664 |
| CALCulate<Ch>:PARAmeter:DELete.....                                                      | 666 |
| CALCulate<Ch>:PARAmeter:DELete:CALL.....                                                 | 667 |
| CALCulate<Ch>:PARAmeter:DELete:CMEMory.....                                              | 667 |
| CALCulate<Ch>:PARAmeter:DELete:SGRoup.....                                               | 667 |
| CALCulate<Ch>:PARAmeter:MEASure.....                                                     | 667 |
| CALCulate<Ch>:PARAmeter:MEASure:SENDED.....                                              | 668 |
| CALCulate<Ch>:PARAmeter:SDEFine.....                                                     | 668 |
| CALCulate<Ch>:PARAmeter:SDEFine:SENDED.....                                              | 670 |
| CALCulate<Ch>:PARAmeter:SELect.....                                                      | 671 |
| CALCulate<Ch>:TRANSform:VNETworks:BALanced:DEEMbedding<LogPt>:PARAmeters:C<Cmp>.....     | 709 |
| CALCulate<Ch>:TRANSform:VNETworks:BALanced:DEEMbedding<LogPt>:PARAmeters:DATA<Port>..... | 709 |
| CALCulate<Ch>:TRANSform:VNETworks:BALanced:DEEMbedding<LogPt>:PARAmeters:G<Cmp>.....     | 710 |
| CALCulate<Ch>:TRANSform:VNETworks:BALanced:DEEMbedding<LogPt>:PARAmeters:L<Cmp>.....     | 711 |
| CALCulate<Ch>:TRANSform:VNETworks:BALanced:DEEMbedding<LogPt>:PARAmeters:R<Cmp>.....     | 712 |
| CALCulate<Ch>:TRANSform:VNETworks:BALanced:DEEMbedding<LogPt>:TNDefinition.....          | 713 |
| CALCulate<Ch>:TRANSform:VNETworks:BALanced:DEEMbedding<LogPt>[:STATe].....               | 708 |
| CALCulate<Ch>:TRANSform:VNETworks:BALanced:EMBedding<LogPt>:PARAmeters:C<Cmp>.....       | 714 |
| CALCulate<Ch>:TRANSform:VNETworks:BALanced:EMBedding<LogPt>:PARAmeters:DATA<Port>.....   | 714 |
| CALCulate<Ch>:TRANSform:VNETworks:BALanced:EMBedding<LogPt>:PARAmeters:G<Cmp>.....       | 715 |
| CALCulate<Ch>:TRANSform:VNETworks:BALanced:EMBedding<LogPt>:PARAmeters:L<Cmp>.....       | 716 |
| CALCulate<Ch>:TRANSform:VNETworks:BALanced:EMBedding<LogPt>:PARAmeters:R<Cmp>.....       | 717 |
| CALCulate<Ch>:TRANSform:VNETworks:BALanced:EMBedding<LogPt>:TNDefinition.....            | 718 |
| CALCulate<Ch>:TRANSform:VNETworks:BALanced:EMBedding<LogPt>[:STATe].....                 | 713 |
| CALCulate<Ch>:TRANSform:VNETworks:DIFFerential:EMBedding<LogPt>:PARAmeters:C<Cmp>.....   | 718 |
| CALCulate<Ch>:TRANSform:VNETworks:DIFFerential:EMBedding<LogPt>:PARAmeters:DATA.....     | 719 |
| CALCulate<Ch>:TRANSform:VNETworks:DIFFerential:EMBedding<LogPt>:PARAmeters:G<Cmp>.....   | 719 |
| CALCulate<Ch>:TRANSform:VNETworks:DIFFerential:EMBedding<LogPt>:PARAmeters:L<Cmp>.....   | 720 |
| CALCulate<Ch>:TRANSform:VNETworks:DIFFerential:EMBedding<LogPt>:PARAmeters:R<Cmp>.....   | 720 |
| CALCulate<Ch>:TRANSform:VNETworks:DIFFerential:EMBedding<LogPt>:TNDefinition.....        | 721 |
| CALCulate<Ch>:TRANSform:VNETworks:DIFFerential:EMBedding<LogPt>[:STATe].....             | 718 |
| CALCulate<Ch>:TRANSform:VNETworks:FSIMulator[:STATe].....                                | 727 |
| CALCulate<Ch>:TRANSform:VNETworks:GLOop:DEEMbedding:PARAmeters:C.....                    | 722 |
| CALCulate<Ch>:TRANSform:VNETworks:GLOop:DEEMbedding:PARAmeters:G.....                    | 722 |
| CALCulate<Ch>:TRANSform:VNETworks:GLOop:DEEMbedding:PARAmeters:L.....                    | 723 |
| CALCulate<Ch>:TRANSform:VNETworks:GLOop:DEEMbedding:PARAmeters:R.....                    | 723 |
| CALCulate<Ch>:TRANSform:VNETworks:GLOop:DEEMbedding:TNDefinition.....                    | 724 |
| CALCulate<Ch>:TRANSform:VNETworks:GLOop:DEEMbedding[:STATe].....                         | 721 |
| CALCulate<Ch>:TRANSform:VNETworks:GLOop:EMBedding:PARAmeters:C.....                      | 725 |
| CALCulate<Ch>:TRANSform:VNETworks:GLOop:EMBedding:PARAmeters:G.....                      | 725 |

|                                                                                      |     |
|--------------------------------------------------------------------------------------|-----|
| CALCulate<Ch>:TRANSform:VNETworks:GLOop:EMBedding:PARAmeters:L.....                  | 726 |
| CALCulate<Ch>:TRANSform:VNETworks:GLOop:EMBedding:PARAmeters:R.....                  | 726 |
| CALCulate<Ch>:TRANSform:VNETworks:GLOop:EMBedding:TNDefinition.....                  | 727 |
| CALCulate<Ch>:TRANSform:VNETworks:GLOop:EMBedding[:STATE].....                       | 724 |
| CALCulate<Ch>:TRANSform:VNETworks:PPAir:DEEMbedding:DELeTe.....                      | 727 |
| CALCulate<Ch>:TRANSform:VNETworks:PPAir:DEEMbedding<ListId>:DEFine.....              | 728 |
| CALCulate<Ch>:TRANSform:VNETworks:PPAir:DEEMbedding<ListId>:PARAmeters:C<1 2 3>..... | 729 |
| CALCulate<Ch>:TRANSform:VNETworks:PPAir:DEEMbedding<ListId>:PARAmeters:G<1 2 3>..... | 730 |
| CALCulate<Ch>:TRANSform:VNETworks:PPAir:DEEMbedding<ListId>:PARAmeters:L<1 2 3>..... | 730 |
| CALCulate<Ch>:TRANSform:VNETworks:PPAir:DEEMbedding<ListId>:PARAmeters:R<1 2 3>..... | 731 |
| CALCulate<Ch>:TRANSform:VNETworks:PPAir:DEEMbedding<ListId>:TNDefinition.....        | 732 |
| CALCulate<Ch>:TRANSform:VNETworks:PPAir:DEEMbedding<ListId>[:STATE].....             | 728 |
| CALCulate<Ch>:TRANSform:VNETworks:PPAir:EMBedding<ListId>:DEFine.....                | 733 |
| CALCulate<Ch>:TRANSform:VNETworks:PPAir:EMBedding<ListId>:DELeTe.....                | 733 |
| CALCulate<Ch>:TRANSform:VNETworks:PPAir:EMBedding<ListId>:PARAmeters:C<1 2 3>.....   | 734 |
| CALCulate<Ch>:TRANSform:VNETworks:PPAir:EMBedding<ListId>:PARAmeters:G<1 2 3>.....   | 736 |
| CALCulate<Ch>:TRANSform:VNETworks:PPAir:EMBedding<ListId>:PARAmeters:L<1 2 3>.....   | 735 |
| CALCulate<Ch>:TRANSform:VNETworks:PPAir:EMBedding<ListId>:PARAmeters:R<1 2 3>.....   | 735 |
| CALCulate<Ch>:TRANSform:VNETworks:PPAir:EMBedding<ListId>:TNDefinition.....          | 737 |
| CALCulate<Ch>:TRANSform:VNETworks:PPAir:EMBedding<ListId>[:STATE].....               | 732 |
| CALCulate<Ch>:TRANSform:VNETworks:PSET:DEEMbedding<ListId>:DEFine.....               | 737 |
| CALCulate<Ch>:TRANSform:VNETworks:PSET:EMBedding<ListId>:DEFine.....                 | 737 |
| CALCulate<Ch>:TRANSform:VNETworks:SENDEd:DEEMbedding<PhyPt>:PARAmeters:C<Cmp>.....   | 739 |
| CALCulate<Ch>:TRANSform:VNETworks:SENDEd:DEEMbedding<PhyPt>:PARAmeters:DATA.....     | 738 |
| CALCulate<Ch>:TRANSform:VNETworks:SENDEd:DEEMbedding<PhyPt>:PARAmeters:G<Cmp>.....   | 740 |
| CALCulate<Ch>:TRANSform:VNETworks:SENDEd:DEEMbedding<PhyPt>:PARAmeters:L<Cmp>.....   | 741 |
| CALCulate<Ch>:TRANSform:VNETworks:SENDEd:DEEMbedding<PhyPt>:PARAmeters:R<Cmp>.....   | 741 |
| CALCulate<Ch>:TRANSform:VNETworks:SENDEd:DEEMbedding<PhyPt>:TNDefinition.....        | 742 |
| CALCulate<Ch>:TRANSform:VNETworks:SENDEd:DEEMbedding<PhyPt>[:STATE].....             | 738 |
| CALCulate<Ch>:TRANSform:VNETworks:SENDEd:EMBedding<PhyPt>:PARAmeters:C<Cmp>.....     | 744 |
| CALCulate<Ch>:TRANSform:VNETworks:SENDEd:EMBedding<PhyPt>:PARAmeters:DATA.....       | 743 |
| CALCulate<Ch>:TRANSform:VNETworks:SENDEd:EMBedding<PhyPt>:PARAmeters:G<Cmp>.....     | 744 |
| CALCulate<Ch>:TRANSform:VNETworks:SENDEd:EMBedding<PhyPt>:PARAmeters:L<Cmp>.....     | 745 |
| CALCulate<Ch>:TRANSform:VNETworks:SENDEd:EMBedding<PhyPt>:PARAmeters:R<Cmp>.....     | 746 |
| CALCulate<Ch>:TRANSform:VNETworks:SENDEd:EMBedding<PhyPt>:TNDefinition.....          | 747 |
| CALCulate<Ch>:TRANSform:VNETworks:SENDEd:EMBedding<PhyPt>[:STATE].....               | 742 |
| CALCulate<Chn>:DATA.....                                                             | 602 |
| CALCulate<Chn>:DATA:NSWeep:COUNT?.....                                               | 606 |
| CALCulate<Chn>:DATA:NSWeep:FIRST?.....                                               | 606 |
| CALCulate<Chn>:DATA:NSWeep[:LAST]?.....                                              | 605 |
| CALCulate<Chn>:DATA:STIMulus?.....                                                   | 607 |
| CALCulate<Chn>:DLINe.....                                                            | 608 |
| CALCulate<Chn>:DLINe:STATe.....                                                      | 608 |
| CALCulate<Chn>:FILTer[:GATE]:TIME:CENTer.....                                        | 610 |
| CALCulate<Chn>:FILTer[:GATE]:TIME:DCHebyshev.....                                    | 610 |
| CALCulate<Chn>:FILTer[:GATE]:TIME:SHAPE.....                                         | 610 |
| CALCulate<Chn>:FILTer[:GATE]:TIME:SHOW.....                                          | 611 |
| CALCulate<Chn>:FILTer[:GATE]:TIME:SPAN.....                                          | 611 |
| CALCulate<Chn>:FILTer[:GATE]:TIME:START.....                                         | 612 |
| CALCulate<Chn>:FILTer[:GATE]:TIME:STATe.....                                         | 612 |



|                                                        |     |
|--------------------------------------------------------|-----|
| CALCulate<Chn>:FILTer[:GATE]:TIME:STOP.....            | 612 |
| CALCulate<Chn>:FILTer[:GATE]:TIME:WINDow.....          | 613 |
| CALCulate<Chn>:FILTer[:GATE]:TIME[:TYPE].....          | 609 |
| CALCulate<Chn>:FORMat.....                             | 613 |
| CALCulate<Chn>:FORMat:WQUType.....                     | 615 |
| CALCulate<Chn>:GDAPerture:SCOunt.....                  | 615 |
| CALCulate<Chn>:IAverage:MODE.....                      | 616 |
| CALCulate<Chn>:IAverage[:STATe].....                   | 615 |
| CALCulate<Chn>:LIMit:CIRClE:CLEar.....                 | 618 |
| CALCulate<Chn>:LIMit:CIRClE:DATA.....                  | 618 |
| CALCulate<Chn>:LIMit:CIRClE:DISPlay[:STATe].....       | 619 |
| CALCulate<Chn>:LIMit:CIRClE:FAIL?.....                 | 619 |
| CALCulate<Chn>:LIMit:CIRClE:SOUNd[:STATe].....         | 619 |
| CALCulate<Chn>:LIMit:CIRClE[:STATe].....               | 618 |
| CALCulate<Chn>:LIMit:CLEar.....                        | 620 |
| CALCulate<Chn>:LIMit:CONTRol:DOMain.....               | 936 |
| CALCulate<Chn>:LIMit:CONTRol:SHIFt.....                | 621 |
| CALCulate<Chn>:LIMit:CONTRol[:DATA].....               | 620 |
| CALCulate<Chn>:LIMit:DATA.....                         | 621 |
| CALCulate<Chn>:LIMit:DCIRclE:CLEar.....                | 623 |
| CALCulate<Chn>:LIMit:DCIRclE:DATA.....                 | 623 |
| CALCulate<Chn>:LIMit:DCIRclE:DISPlay[:STATe].....      | 623 |
| CALCulate<Chn>:LIMit:DCIRclE[:STATe].....              | 622 |
| CALCulate<Chn>:LIMit:DELeTe:ALL.....                   | 623 |
| CALCulate<Chn>:LIMit:DISPlay[:STATe].....              | 624 |
| CALCulate<Chn>:LIMit:FAIL?.....                        | 624 |
| CALCulate<Chn>:LIMit:LOWer:FEED.....                   | 626 |
| CALCulate<Chn>:LIMit:LOWer:SHIFt.....                  | 627 |
| CALCulate<Chn>:LIMit:LOWer:STATe.....                  | 938 |
| CALCulate<Chn>:LIMit:LOWer[:DATA].....                 | 625 |
| CALCulate<Chn>:LIMit:RDOMain:COMPlEx.....              | 936 |
| CALCulate<Chn>:LIMit:RDOMain:FORMat.....               | 937 |
| CALCulate<Chn>:LIMit:RDOMain:SPACing.....              | 937 |
| CALCulate<Chn>:LIMit:SEGMENT:COUNT?.....               | 628 |
| CALCulate<Chn>:LIMit:SEGMENT<Seg>:AMPLitude:START..... | 628 |
| CALCulate<Chn>:LIMit:SEGMENT<Seg>:AMPLitude:STOP.....  | 628 |
| CALCulate<Chn>:LIMit:SEGMENT<Seg>:FORMula.....         | 629 |
| CALCulate<Chn>:LIMit:SEGMENT<Seg>:FORMula:STATe.....   | 629 |
| CALCulate<Chn>:LIMit:SEGMENT<Seg>:INTerpol.....        | 630 |
| CALCulate<Chn>:LIMit:SEGMENT<Seg>:STIMulus:START.....  | 630 |
| CALCulate<Chn>:LIMit:SEGMENT<Seg>:STIMulus:STOP.....   | 630 |
| CALCulate<Chn>:LIMit:SEGMENT<Seg>:TYPE.....            | 631 |
| CALCulate<Chn>:LIMit:SOUNd[:STATe].....                | 632 |
| CALCulate<Chn>:LIMit:STATe.....                        | 632 |
| CALCulate<Chn>:LIMit:STATe:AREA.....                   | 632 |
| CALCulate<Chn>:LIMit:TTLout<Pt>[:STATe].....           | 633 |
| CALCulate<Chn>:LIMit:UPPer:FEED.....                   | 626 |
| CALCulate<Chn>:LIMit:UPPer:SHIFt.....                  | 627 |
| CALCulate<Chn>:LIMit:UPPer:STATe.....                  | 938 |
| CALCulate<Chn>:LIMit:UPPer[:DATA].....                 | 625 |

|                                                               |     |
|---------------------------------------------------------------|-----|
| CALCulate<Chn>:MARKer:DEFault:FORMat.....                     | 636 |
| CALCulate<Chn>:MARKer:MPEak:EXCursion.....                    | 637 |
| CALCulate<Chn>:MARKer:MPEak:EXCursion:STATe.....              | 638 |
| CALCulate<Chn>:MARKer:MPEak:THReshold.....                    | 638 |
| CALCulate<Chn>:MARKer:MPEak:THReshold:STATe.....              | 638 |
| CALCulate<Chn>:MARKer:SEARch:BFILter:RESult[:STATe].....      | 639 |
| CALCulate<Chn>:MARKer:SEARch:BFILter:RESult[:STATe]:AREA..... | 639 |
| CALCulate<Chn>:MARKer[:STATe]:AREA.....                       | 636 |
| CALCulate<Chn>:MARKer<Mk>:AOFF.....                           | 639 |
| CALCulate<Chn>:MARKer<Mk>:BWIDth.....                         | 640 |
| CALCulate<Chn>:MARKer<Mk>:DELTA[:STATe].....                  | 641 |
| CALCulate<Chn>:MARKer<Mk>:EXCursion.....                      | 641 |
| CALCulate<Chn>:MARKer<Mk>:EXCursion:STATe.....                | 642 |
| CALCulate<Chn>:MARKer<Mk>:FORMat.....                         | 642 |
| CALCulate<Chn>:MARKer<Mk>:FUNCTion:BWIDth.....                | 939 |
| CALCulate<Chn>:MARKer<Mk>:FUNCTion:BWIDth:MODE.....           | 643 |
| CALCulate<Chn>:MARKer<Mk>:FUNCTion:CENTer.....                | 643 |
| CALCulate<Chn>:MARKer<Mk>:FUNCTion:DELTA:STATe.....           | 940 |
| CALCulate<Chn>:MARKer<Mk>:FUNCTion:DOMain:USER:SHOW.....      | 644 |
| CALCulate<Chn>:MARKer<Mk>:FUNCTion:DOMain:USER:STARt.....     | 645 |
| CALCulate<Chn>:MARKer<Mk>:FUNCTion:DOMain:USER:STOP.....      | 645 |
| CALCulate<Chn>:MARKer<Mk>:FUNCTion:DOMain:USER[:RANGe].....   | 644 |
| CALCulate<Chn>:MARKer<Mk>:FUNCTion:EXECute.....               | 645 |
| CALCulate<Chn>:MARKer<Mk>:FUNCTion:RESult?.....               | 646 |
| CALCulate<Chn>:MARKer<Mk>:FUNCTion:SPAN.....                  | 646 |
| CALCulate<Chn>:MARKer<Mk>:FUNCTion:STARt.....                 | 647 |
| CALCulate<Chn>:MARKer<Mk>:FUNCTion:STOP.....                  | 647 |
| CALCulate<Chn>:MARKer<Mk>:FUNCTion:TARGet.....                | 940 |
| CALCulate<Chn>:MARKer<Mk>:FUNCTion[:SELect].....              | 941 |
| CALCulate<Chn>:MARKer<Mk>:MAXimum.....                        | 941 |
| CALCulate<Chn>:MARKer<Mk>:MINimum.....                        | 941 |
| CALCulate<Chn>:MARKer<Mk>:MODE.....                           | 647 |
| CALCulate<Chn>:MARKer<Mk>:NAME.....                           | 648 |
| CALCulate<Chn>:MARKer<Mk>:REFerence:FORMat.....               | 649 |
| CALCulate<Chn>:MARKer<Mk>:REFerence:MODE.....                 | 649 |
| CALCulate<Chn>:MARKer<Mk>:REFerence:NAME.....                 | 650 |
| CALCulate<Chn>:MARKer<Mk>:REFerence:TYPE.....                 | 650 |
| CALCulate<Chn>:MARKer<Mk>:REFerence:X.....                    | 651 |
| CALCulate<Chn>:MARKer<Mk>:REFerence:Y.....                    | 652 |
| CALCulate<Chn>:MARKer<Mk>:REFerence[:STATe].....              | 648 |
| CALCulate<Chn>:MARKer<Mk>:SEARch:FORMat.....                  | 653 |
| CALCulate<Chn>:MARKer<Mk>:SEARch:LEFT.....                    | 942 |
| CALCulate<Chn>:MARKer<Mk>:SEARch:NEXt.....                    | 942 |
| CALCulate<Chn>:MARKer<Mk>:SEARch:RIGHT.....                   | 942 |
| CALCulate<Chn>:MARKer<Mk>:SEARch:TRACKing.....                | 652 |
| CALCulate<Chn>:MARKer<Mk>:SEARch[:IMMediate].....             | 942 |
| CALCulate<Chn>:MARKer<Mk>:TARGet.....                         | 655 |
| CALCulate<Chn>:MARKer<Mk>:THReshold.....                      | 655 |
| CALCulate<Chn>:MARKer<Mk>:THReshold:STATe.....                | 655 |
| CALCulate<Chn>:MARKer<Mk>:TYPE.....                           | 656 |

|                                                          |     |
|----------------------------------------------------------|-----|
| CALCulate<Chn>:MARKer<Mk>:X.....                         | 657 |
| CALCulate<Chn>:MARKer<Mk>:Y.....                         | 658 |
| CALCulate<Chn>:MARKer<Mk>[:STATe].....                   | 654 |
| CALCulate<Chn>:MATH:FORMatted:FUNCTion.....              | 660 |
| CALCulate<Chn>:MATH:FORMatted:STATe.....                 | 662 |
| CALCulate<Chn>:MATH:FORMatted[:EXPRession]:SDEFine.....  | 659 |
| CALCulate<Chn>:MATH:FUNCTion.....                        | 660 |
| CALCulate<Chn>:MATH:MEMorize.....                        | 661 |
| CALCulate<Chn>:MATH:STATe.....                           | 662 |
| CALCulate<Chn>:MATH:WUNit[:STATe].....                   | 662 |
| CALCulate<Chn>:MATH[:EXPRession]:SDEFine.....            | 659 |
| CALCulate<Chn>:MATH[:EXPRession][:DEFine].....           | 942 |
| CALCulate<Chn>:PHOLd.....                                | 671 |
| CALCulate<Chn>:RIPPlE:CLEar.....                         | 673 |
| CALCulate<Chn>:RIPPlE:CONTRol:DOMain.....                | 673 |
| CALCulate<Chn>:RIPPlE:DATA.....                          | 674 |
| CALCulate<Chn>:RIPPlE:DELeTe:ALL.....                    | 674 |
| CALCulate<Chn>:RIPPlE:DISPlay[:STATe].....               | 675 |
| CALCulate<Chn>:RIPPlE:FAIL?.....                         | 675 |
| CALCulate<Chn>:RIPPlE:RDOMain:FORMat.....                | 676 |
| CALCulate<Chn>:RIPPlE:SEGMENT:COUNT?.....                | 676 |
| CALCulate<Chn>:RIPPlE:SEGMENT<Seg>:LIMit.....            | 677 |
| CALCulate<Chn>:RIPPlE:SEGMENT<Seg>:RESult?.....          | 678 |
| CALCulate<Chn>:RIPPlE:SEGMENT<Seg>:STIMulus:START.....   | 679 |
| CALCulate<Chn>:RIPPlE:SEGMENT<Seg>:STIMulus:STOP.....    | 679 |
| CALCulate<Chn>:RIPPlE:SEGMENT<Seg>[:STATe].....          | 677 |
| CALCulate<Chn>:RIPPlE:SOUNd[:STATe].....                 | 679 |
| CALCulate<Chn>:RIPPlE:STATe.....                         | 680 |
| CALCulate<Chn>:RIPPlE:STATe:AREA.....                    | 680 |
| CALCulate<Chn>:SMOothing:APERture.....                   | 681 |
| CALCulate<Chn>:SMOothing[:STATe].....                    | 680 |
| CALCulate<Chn>:STATistics:DOMain:USER.....               | 683 |
| CALCulate<Chn>:STATistics:DOMain:USER:SHOW.....          | 683 |
| CALCulate<Chn>:STATistics:DOMain:USER:START.....         | 683 |
| CALCulate<Chn>:STATistics:DOMain:USER:STOP.....          | 683 |
| CALCulate<Chn>:STATistics:EPDelay[:STATe].....           | 684 |
| CALCulate<Chn>:STATistics:FORMat.....                    | 684 |
| CALCulate<Chn>:STATistics:MMPTpeak[:STATe].....          | 684 |
| CALCulate<Chn>:STATistics:MSTDdev[:STATe].....           | 684 |
| CALCulate<Chn>:STATistics:RESult?.....                   | 684 |
| CALCulate<Chn>:STATistics:RMS[:STATe].....               | 685 |
| CALCulate<Chn>:STATistics:SFLatness[:STATe].....         | 685 |
| CALCulate<Chn>:STATistics[:STATe].....                   | 681 |
| CALCulate<Chn>:STATistics[:STATe]:AREA.....              | 682 |
| CALCulate<Chn>:TRANSform:COMPLex.....                    | 686 |
| CALCulate<Chn>:TRANSform:DTFault:CENTer.....             | 696 |
| CALCulate<Chn>:TRANSform:DTFault:DEFine.....             | 695 |
| CALCulate<Chn>:TRANSform:DTFault:DELeTe.....             | 696 |
| CALCulate<Chn>:TRANSform:DTFault:PEAK:COUNT?.....        | 697 |
| CALCulate<Chn>:TRANSform:DTFault:PEAK:DATA<FaultNo>..... | 697 |

|                                                               |     |
|---------------------------------------------------------------|-----|
| CALCulate<Chn>:TRANSform:DTFault:PEAK:STATE.....              | 698 |
| CALCulate<Chn>:TRANSform:DTFault:PEAK:THReshold.....          | 698 |
| CALCulate<Chn>:TRANSform:DTFault:POINts.....                  | 699 |
| CALCulate<Chn>:TRANSform:DTFault:SElect.....                  | 696 |
| CALCulate<Chn>:TRANSform:DTFault:SPAN.....                    | 696 |
| CALCulate<Chn>:TRANSform:DTFault:STARt.....                   | 699 |
| CALCulate<Chn>:TRANSform:DTFault:STATe.....                   | 700 |
| CALCulate<Chn>:TRANSform:DTFault:STOP.....                    | 699 |
| CALCulate<Chn>:TRANSform:IMPedance:RNORmal.....               | 687 |
| CALCulate<Chn>:TRANSform:TIME:CENTer.....                     | 688 |
| CALCulate<Chn>:TRANSform:TIME:DCHebyshev.....                 | 689 |
| CALCulate<Chn>:TRANSform:TIME:LPASs.....                      | 689 |
| CALCulate<Chn>:TRANSform:TIME:LPASs:DCSParam.....             | 689 |
| CALCulate<Chn>:TRANSform:TIME:LPASs:DCSParam:CONTInuous.....  | 690 |
| CALCulate<Chn>:TRANSform:TIME:LPASs:DCSParam:EXTRapolate..... | 691 |
| CALCulate<Chn>:TRANSform:TIME:LPFRequency.....                | 691 |
| CALCulate<Chn>:TRANSform:TIME:RESolution:EFACtor.....         | 691 |
| CALCulate<Chn>:TRANSform:TIME:SPAN.....                       | 691 |
| CALCulate<Chn>:TRANSform:TIME:STARt.....                      | 692 |
| CALCulate<Chn>:TRANSform:TIME:STATe.....                      | 692 |
| CALCulate<Chn>:TRANSform:TIME:STIMulus.....                   | 693 |
| CALCulate<Chn>:TRANSform:TIME:STOP.....                       | 693 |
| CALCulate<Chn>:TRANSform:TIME:WINDow.....                     | 694 |
| CALCulate<Chn>:TRANSform:TIME:XAXis.....                      | 694 |
| CALCulate<Chn>:TRANSform:TIME[:TYPE].....                     | 687 |
| CALibration:RESult?.....                                      | 559 |
| CALibration[:ALL]?.....                                       | 559 |
| CONFigure:CHANnel:CATalog?.....                               | 747 |
| CONFigure:CHANnel:MEASure:ALL[:STATe].....                    | 748 |
| CONFigure:CHANnel:MEASure:OPTImized.....                      | 748 |
| CONFigure:CHANnel<Ch>:MEASure[:STATe].....                    | 750 |
| CONFigure:CHANnel<Ch>:NAME.....                               | 750 |
| CONFigure:CHANnel<Ch>:NAME:ID?.....                           | 751 |
| CONFigure:CHANnel<Ch>:TRACe:CATalog?.....                     | 751 |
| CONFigure:CHANnel<Ch>:TRACe:REName.....                       | 751 |
| CONFigure:CHANnel<Ch>[:STATe].....                            | 749 |
| CONFigure:TRACe:CATalog?.....                                 | 752 |
| CONFigure:TRACe:WINDow:TRACe?.....                            | 753 |
| CONFigure:TRACe:WINDow?.....                                  | 752 |
| CONFigure:TRACe<Trc>:CHANnel:NAME:ID?.....                    | 753 |
| CONFigure:TRACe<Trc>:CHANnel:NAME?.....                       | 753 |
| CONFigure:TRACe<Trc>:NAME.....                                | 754 |
| CONFigure:TRACe<Trc>:NAME:ID?.....                            | 754 |
| CONFigure:TRACe<Trc>:REName.....                              | 754 |
| CONTRol:AUXiliary:C[:DATA].....                               | 755 |
| DIAGnostic:DUMP:SIZE.....                                     | 757 |
| DIAGnostic:SERVice:BATTery:LEVel?.....                        | 571 |
| DIAGnostic:SERVice:BIOSinfo?.....                             | 571 |
| DIAGnostic:SERVice:FUNCTion.....                              | 943 |
| DIAGnostic:SERVice:HWINfo?.....                               | 571 |

|                                                    |     |
|----------------------------------------------------|-----|
| DIAGnostic:SERVice:INPut:PULSed:CFRequency.....    | 559 |
| DIAGnostic:SERVice:INPut:PULSed:MCFRequency.....   | 560 |
| DIAGnostic:SERVice:INPut:RF[:SPEctrum].....        | 560 |
| DIAGnostic:SERVice:INPut[:SElect].....             | 560 |
| DIAGnostic:SERVice:RFPower.....                    | 757 |
| DIAGnostic:SERVice:SFUNction.....                  | 574 |
| DIAGnostic:SERVice:SFUNction:LASTresult?.....      | 574 |
| DIAGnostic:SERVice:SFUNction:RESults:DELeTe.....   | 575 |
| DIAGnostic:SERVice:SFUNction:RESults:SAVE.....     | 575 |
| DIAGnostic:SERVice:SINfo?.....                     | 575 |
| DIAGnostic:SERVice:STESt:RESult?.....              | 560 |
| DIAGnostic:SERVice:VERSinfo?.....                  | 572 |
| DISPlay:ANNotation:CBAR.....                       | 562 |
| DISPlay:ANNotation:CHANnel[:STATe].....            | 774 |
| DISPlay:ANNotation:FREQuency.....                  | 562 |
| DISPlay:ANNotation:FREQuency[:STATe].....          | 774 |
| DISPlay:ANNotation:TRACe[:STATe].....              | 774 |
| DISPlay:ATAB.....                                  | 526 |
| DISPlay:BLIGHting.....                             | 562 |
| DISPlay:CMAP<it>:DEFault<ci>.....                  | 565 |
| DISPlay:IWINDow:BFILter[:STATe].....               | 759 |
| DISPlay:IWINDow:MARKer<Mk>[:STATe].....            | 759 |
| DISPlay:IWINDow[:STATe].....                       | 759 |
| DISPlay:LAYout.....                                | 774 |
| DISPlay:LAYout:APPLY.....                          | 775 |
| DISPlay:LAYout:DEFine.....                         | 775 |
| DISPlay:LAYout:EXECute.....                        | 776 |
| DISPlay:LAYout:GRID.....                           | 777 |
| DISPlay:LAYout:JOIN.....                           | 777 |
| DISPlay:LOGO.....                                  | 544 |
| DISPlay:RFSize.....                                | 777 |
| DISPlay:SBAR[:STATe].....                          | 562 |
| DISPlay:SKEYs[:STATe].....                         | 563 |
| DISPlay:TBAR[:STATe].....                          | 563 |
| DISPlay:THEMe:CATalog?.....                        | 566 |
| DISPlay:THEMe:SElect.....                          | 566 |
| DISPlay:TOUCHscreen[:STATe].....                   | 563 |
| DISPlay[:WINDow<n>]:TIME.....                      | 563 |
| DISPlay[:WINDow<n>]:TIME:FORMat.....               | 564 |
| DISPlay[:WINDow<Wnd>]:CATalog?.....                | 760 |
| DISPlay[:WINDow<Wnd>]:MAXimize.....                | 760 |
| DISPlay[:WINDow<Wnd>]:NAME.....                    | 761 |
| DISPlay[:WINDow<Wnd>]:OVERview[:STATe].....        | 761 |
| DISPlay[:WINDow<Wnd>]:TITLe:DATA.....              | 762 |
| DISPlay[:WINDow<Wnd>]:TITLe[:STATe].....           | 762 |
| DISPlay[:WINDow<Wnd>]:TRACe<WndTr>:CATalog?.....   | 762 |
| DISPlay[:WINDow<Wnd>]:TRACe<WndTr>:DELeTe.....     | 763 |
| DISPlay[:WINDow<Wnd>]:TRACe<WndTr>:EFEed.....      | 763 |
| DISPlay[:WINDow<Wnd>]:TRACe<WndTr>:FEED.....       | 764 |
| DISPlay[:WINDow<Wnd>]:TRACe<WndTr>:LABel:SHOW..... | 764 |

|                                                             |     |
|-------------------------------------------------------------|-----|
| DISPlay[:WINDow<Wnd>]:TRACe<WndTr>:SHOW.....                | 765 |
| DISPlay[:WINDow<Wnd>]:TRACe<WndTr>:X:OFFSet.....            | 766 |
| DISPlay[:WINDow<Wnd>]:TRACe<WndTr>:Y:OFFSet.....            | 771 |
| DISPlay[:WINDow<Wnd>]:TRACe<WndTr>:Y[:SCALE]:AUTO.....      | 766 |
| DISPlay[:WINDow<Wnd>]:TRACe<WndTr>:Y[:SCALE]:BOTTom.....    | 767 |
| DISPlay[:WINDow<Wnd>]:TRACe<WndTr>:Y[:SCALE]:PDIVision..... | 768 |
| DISPlay[:WINDow<Wnd>]:TRACe<WndTr>:Y[:SCALE]:RLEVel.....    | 769 |
| DISPlay[:WINDow<Wnd>]:TRACe<WndTr>:Y[:SCALE]:RPOsition..... | 770 |
| DISPlay[:WINDow<Wnd>]:TRACe<WndTr>:Y[:SCALE]:TOP.....       | 767 |
| DISPlay[:WINDow<Wnd>]:TRACe<WndTr>:ZOOM:BOTTom.....         | 773 |
| DISPlay[:WINDow<Wnd>]:TRACe<WndTr>:ZOOM:START.....          | 773 |
| DISPlay[:WINDow<Wnd>]:TRACe<WndTr>:ZOOM:STOP.....           | 773 |
| DISPlay[:WINDow<Wnd>]:TRACe<WndTr>:ZOOM:TOP.....            | 773 |
| DISPlay[:WINDow<Wnd>]:TRACe<WndTr>:ZOOM[:STATe].....        | 772 |
| DISPlay[:WINDow<Wnd>][:STATe].....                          | 759 |
| FORMat:DEXPort:DSEParator.....                              | 534 |
| FORMat:DEXPort:SOURce.....                                  | 943 |
| FORMat[:DATA].....                                          | 778 |
| HCOPY:ABORt.....                                            | 545 |
| HCOPY:CMAP<it>:DEFault<ci>.....                             | 546 |
| HCOPY:CONTent.....                                          | 545 |
| HCOPY:DESTination<1 2>.....                                 | 546 |
| HCOPY:DEVice:COLor.....                                     | 547 |
| HCOPY:DEVice:LANGUage<1 2>.....                             | 547 |
| HCOPY:ITEM:WINDow<1 2>:TEXT.....                            | 548 |
| HCOPY:PAGE:COUNT:STATe.....                                 | 549 |
| HCOPY:PAGE:MARGin<1 2>:BOTTom.....                          | 549 |
| HCOPY:PAGE:MARGin<1 2>:LEFT.....                            | 549 |
| HCOPY:PAGE:MARGin<1 2>:RIGHT.....                           | 550 |
| HCOPY:PAGE:MARGin<1 2>:TOP.....                             | 550 |
| HCOPY:PAGE:MARGin<1 2>:UNIT.....                            | 550 |
| HCOPY:PAGE:ORlentation<1 2>.....                            | 551 |
| HCOPY:PAGE:WINDow<1 2>:CHANnel:STATe.....                   | 551 |
| HCOPY:PAGE:WINDow<1 2>:COUNT.....                           | 551 |
| HCOPY:PAGE:WINDow<1 2>:SCALE.....                           | 552 |
| HCOPY:PAGE:WINDow<1 2>:STATe.....                           | 552 |
| HCOPY:TDSamp:STATe<1 2>.....                                | 553 |
| HCOPY[:IMMEDIATE<1 2>].....                                 | 548 |
| HCOPY[:IMMEDIATE<1 2>]:NEXT.....                            | 548 |
| INITiate:CONTInuous:ALL.....                                | 779 |
| INITiate:SEQuencer:ABORt.....                               | 529 |
| INITiate:SEQuencer:IMMEDIATE.....                           | 530 |
| INITiate:SEQuencer:MODE.....                                | 530 |
| INITiate[:IMMEDIATE]:ALL.....                               | 779 |
| INITiate<Ch>:CONTInuous.....                                | 781 |
| INITiate<Ch>[:IMMEDIATE]:SCOPE.....                         | 780 |
| INITiate<Ch>[:IMMEDIATE][:DUMMy].....                       | 780 |
| INPut<PhyPt>:ATTenuation.....                               | 944 |
| INSTrument:CREate:DUPLicate.....                            | 526 |
| INSTrument:CREate:REPLace.....                              | 527 |

|                                                               |     |
|---------------------------------------------------------------|-----|
| INSTrument:CREate[:NEW].....                                  | 527 |
| INSTrument:DELeTe.....                                        | 527 |
| INSTrument:LIST?.....                                         | 528 |
| INSTrument:NSElect.....                                       | 782 |
| INSTrument:PORT:COUNT?.....                                   | 782 |
| INSTrument:REName.....                                        | 528 |
| INSTrument:TPORT:COUNT?.....                                  | 782 |
| INSTrument[:SElect].....                                      | 529 |
| INSTrument[:SElect].....                                      | 944 |
| LAYout:CATalog[:WINDow]?.....                                 | 782 |
| MMEMory:AKAL:FACtory:CONVersion.....                          | 784 |
| MMEMory:AKAL:USER:CONVersion.....                             | 784 |
| MMEMory:CATalog.....                                          | 535 |
| MMEMory:CATalog:LONG.....                                     | 535 |
| MMEMory:CDIRectory.....                                       | 535 |
| MMEMory:CKIT:INFO?.....                                       | 785 |
| MMEMory:CLEar:ALL.....                                        | 539 |
| MMEMory:CLEar:STATe.....                                      | 540 |
| MMEMory:COMMeNt.....                                          | 535 |
| MMEMory:COpy.....                                             | 536 |
| MMEMory:DATA.....                                             | 536 |
| MMEMory:DELeTe:CORRection.....                                | 785 |
| MMEMory:DELeTe:IMMediate.....                                 | 537 |
| MMEMory:LOAD:AUTO.....                                        | 540 |
| MMEMory:LOAD:CABLe.....                                       | 786 |
| MMEMory:LOAD:CKIT.....                                        | 786 |
| MMEMory:LOAD:CKIT:SDATa.....                                  | 787 |
| MMEMory:LOAD:CKIT:SDATa:WLABel.....                           | 788 |
| MMEMory:LOAD:CKIT:UDIRectory.....                             | 789 |
| MMEMory:LOAD:CORRection.....                                  | 790 |
| MMEMory:LOAD:CORRection:MERGe.....                            | 791 |
| MMEMory:LOAD:CORRection:RESolve.....                          | 792 |
| MMEMory:LOAD:LIMit.....                                       | 792 |
| MMEMory:LOAD:RIPPLe.....                                      | 794 |
| MMEMory:LOAD:SEGMeNt.....                                     | 795 |
| MMEMory:LOAD:STATe.....                                       | 540 |
| MMEMory:LOAD:TRACe.....                                       | 796 |
| MMEMory:LOAD:TRACe:AUTO.....                                  | 797 |
| MMEMory:LOAD:TYPE.....                                        | 541 |
| MMEMory:LOAD:VNETworks<Ch>:BALanced:DEEMbedding<LogPt>.....   | 797 |
| MMEMory:LOAD:VNETworks<Ch>:BALanced:EMBedding<LogPt>.....     | 797 |
| MMEMory:LOAD:VNETworks<Ch>:DIFFerential:EMBedding<LogPt>..... | 798 |
| MMEMory:LOAD:VNETworks<Ch>:GLOop:DEEMbedding.....             | 799 |
| MMEMory:LOAD:VNETworks<Ch>:GLOop:EMBedding.....               | 799 |
| MMEMory:LOAD:VNETworks<Ch>:PPAir:DEEMbedding<ListId>.....     | 799 |
| MMEMory:LOAD:VNETworks<Ch>:PPAir:EMBedding<ListId>.....       | 799 |
| MMEMory:LOAD:VNETworks<Ch>:SENDEd:DEEMbedding<PhyPt>.....     | 801 |
| MMEMory:LOAD:VNETworks<Ch>:SENDEd:EMBedding<PhyPt>.....       | 801 |
| MMEMory:MDIRectory.....                                       | 537 |
| MMEMory:MOVE.....                                             | 537 |

|                                                              |     |
|--------------------------------------------------------------|-----|
| MMEMory:MSIS.....                                            | 537 |
| MMEMory:NAME.....                                            | 538 |
| MMEMory:NETWork:DISConnect.....                              | 538 |
| MMEMory:NETWork:MAP.....                                     | 538 |
| MMEMory:NETWork:UNUSeddrives.....                            | 539 |
| MMEMory:NETWork:USEDdrives.....                              | 539 |
| MMEMory:RDIRectory.....                                      | 539 |
| MMEMory:STORe:CABLe.....                                     | 802 |
| MMEMory:STORe:CKIT.....                                      | 802 |
| MMEMory:STORe:CKIT:WLABel.....                               | 803 |
| MMEMory:STORe:CORRection.....                                | 803 |
| MMEMory:STORe:LIMit.....                                     | 803 |
| MMEMory:STORe:MARKer.....                                    | 804 |
| MMEMory:STORe:RIPple.....                                    | 804 |
| MMEMory:STORe:SEGMENT.....                                   | 805 |
| MMEMory:STORe:TRACe.....                                     | 805 |
| MMEMory:STORe:TRACe:CHANnel.....                             | 806 |
| MMEMory:STORe:TRACe:OPTion:BALanced.....                     | 808 |
| MMEMory:STORe:TRACe:OPTion:PLUS.....                         | 808 |
| MMEMory:STORe:TRACe:OPTion:SSEParator.....                   | 808 |
| MMEMory:STORe:TRACe:OPTion:SYMMetric.....                    | 808 |
| MMEMory:STORe:TRACe:OPTion:TABS.....                         | 808 |
| MMEMory:STORe:TRACe:OPTion:TRIM.....                         | 809 |
| MMEMory:STORe:TRACe:PORTs.....                               | 809 |
| MMEMory:STORe<1 2>:STATe.....                                | 542 |
| MMEMory:STORe<1 2>:STATe:NEXT.....                           | 542 |
| MMEMory:STORe<1 2>:TYPE.....                                 | 543 |
| OUTPut:UPORt:ECBits.....                                     | 810 |
| OUTPut<Ch>:UPORt:SEGMENT<Seg>:STATe.....                     | 811 |
| OUTPut<Ch>:UPORt:SEGMENT<Seg>[:VALue].....                   | 811 |
| OUTPut<Ch>:UPORt[:VALue].....                                | 813 |
| OUTPut<Ch>[:STATe].....                                      | 810 |
| OUTPut<Chn>:DPORt.....                                       | 945 |
| PROGAm[:SELEcted]:EXECute.....                               | 815 |
| PROGAm[:SELEcted]:INIMessage.....                            | 816 |
| PROGAm[:SELEcted]:INIPArAmeter.....                          | 816 |
| PROGAm[:SELEcted]:NAME.....                                  | 817 |
| PROGAm[:SELEcted]:RETVAl?.....                               | 817 |
| PROGAm[:SELEcted]:WAIT.....                                  | 818 |
| SOURce:POWer:SWEpend:MODE.....                               | 911 |
| SOURce:POWer:SWEpend:SDELay.....                             | 911 |
| SOURce<Ch>:FREQUency<PhyPt>:FIXed.....                       | 906 |
| SOURce<Ch>:FREQUency<PhyPt>[:CW].....                        | 906 |
| SOURce<Ch>:GROUp<Grp>.....                                   | 909 |
| SOURce<Ch>:GROUp<Grp>:CLEAr.....                             | 909 |
| SOURce<Ch>:GROUp<Grp>:PORTs.....                             | 910 |
| SOURce<Ch>:LPORt<LogPt>.....                                 | 907 |
| SOURce<Ch>:LPORt<LogPt>:CLEAr.....                           | 908 |
| SOURce<Ch>:POWer<PhyPt>[:LEVel][:IMMediate][:AMPLitude]..... | 910 |
| SOURce<si>:TEMPerature:FRONTend.....                         | 561 |



|                                                             |     |
|-------------------------------------------------------------|-----|
| STATus:PRESet.....                                          | 912 |
| STATus:QUESTionable:CONDition?.....                         | 913 |
| STATus:QUESTionable:ENABLE.....                             | 913 |
| STATus:QUESTionable:INTegrity:CONDition?.....               | 913 |
| STATus:QUESTionable:INTegrity:ENABLE.....                   | 913 |
| STATus:QUESTionable:INTegrity:HARDware:CONDition?.....      | 913 |
| STATus:QUESTionable:INTegrity:HARDware:ENABLE.....          | 913 |
| STATus:QUESTionable:INTegrity:HARDware:NTRansition.....     | 914 |
| STATus:QUESTionable:INTegrity:HARDware:PTRansition.....     | 914 |
| STATus:QUESTionable:INTegrity:HARDware[:EVENT]?.....        | 912 |
| STATus:QUESTionable:INTegrity:NTRansition.....              | 914 |
| STATus:QUESTionable:INTegrity:PTRansition.....              | 914 |
| STATus:QUESTionable:INTegrity[:EVENT]?.....                 | 912 |
| STATus:QUESTionable:LIMit<Lev>:CONDition?.....              | 913 |
| STATus:QUESTionable:LIMit<Lev>:ENABLE.....                  | 913 |
| STATus:QUESTionable:LIMit<Lev>:NTRansition.....             | 914 |
| STATus:QUESTionable:LIMit<Lev>:PTRansition.....             | 914 |
| STATus:QUESTionable:LIMit<Lev>[:EVENT]?.....                | 912 |
| STATus:QUESTionable:NTRansition.....                        | 914 |
| STATus:QUESTionable:PTRansition.....                        | 914 |
| STATus:QUESTionable[:EVENT]?.....                           | 912 |
| STATus:QUEue[:NEXT]?.....                                   | 914 |
| SYSTem:CLOGging.....                                        | 525 |
| SYSTem:COMMunicate:AKAL:CONNection.....                     | 915 |
| SYSTem:COMMunicate:AKAL:MMEMory[:STATe].....                | 916 |
| SYSTem:COMMunicate:GPIB[:SELF]:ADDRess.....                 | 567 |
| SYSTem:COMMunicate:GPIB[:SELF]:DCLear:SUPPpress.....        | 916 |
| SYSTem:COMMunicate:GPIB[:SELF]:INIT:WAIT.....               | 916 |
| SYSTem:COMMunicate:GPIB[:SELF]:LPORt:ALIGn.....             | 917 |
| SYSTem:COMMunicate:GPIB[:SELF]:RTERminator.....             | 567 |
| SYSTem:COMMunicate:NET:HOSTname.....                        | 917 |
| SYSTem:COMMunicate:PRINter:ENUMerate:FIRSt.....             | 553 |
| SYSTem:COMMunicate:PRINter:ENUMerate[:NEXT].....            | 553 |
| SYSTem:COMMunicate:PRINter:SElect<1 2>.....                 | 553 |
| SYSTem:COMMunicate:RDEvice:AKAL:ADDRess.....                | 917 |
| SYSTem:COMMunicate:RDEvice:AKAL:ADDRess:ALL?.....           | 918 |
| SYSTem:COMMunicate:RDEvice:AKAL:CKIT:CATalog?.....          | 918 |
| SYSTem:COMMunicate:RDEvice:AKAL:CKIT:STANdard:CATalog?..... | 919 |
| SYSTem:COMMunicate:RDEvice:AKAL:DATE?.....                  | 920 |
| SYSTem:COMMunicate:RDEvice:AKAL:FRANge?.....                | 920 |
| SYSTem:COMMunicate:RDEvice:AKAL:PORtS?.....                 | 921 |
| SYSTem:COMMunicate:RDEvice:AKAL:PREdUction[:STATe].....     | 921 |
| SYSTem:COMMunicate:RDEvice:AKAL:SDATa?.....                 | 921 |
| SYSTem:COMMunicate:RDEvice:AKAL:WARMup[:STATe]?.....        | 922 |
| SYSTem:DATA:MEMory:ADD.....                                 | 923 |
| SYSTem:DATA:MEMory:CATalog?.....                            | 923 |
| SYSTem:DATA:MEMory:COMMit.....                              | 923 |
| SYSTem:DATA:MEMory:DELeTe.....                              | 924 |
| SYSTem:DATA:MEMory:INITalize.....                           | 924 |
| SYSTem:DATA:MEMory:OFFSet?.....                             | 924 |

|                                                 |     |
|-------------------------------------------------|-----|
| SYSTem:DATA:MEMory:RESet.....                   | 924 |
| SYSTem:DATA:MEMory:SIZE?.....                   | 925 |
| SYSTem:DATE.....                                | 564 |
| SYSTem:DATE.....                                | 925 |
| SYSTem:DISPlay:CONDUCTances.....                | 925 |
| SYSTem:DISPlay:FPANel[:STATe].....              | 564 |
| SYSTem:DISPlay:LANGUage.....                    | 566 |
| SYSTem:DISPlay:LOCK.....                        | 568 |
| SYSTem:DISPlay:UPDate.....                      | 568 |
| SYSTem:ERRor:CLEar:ALL.....                     | 572 |
| SYSTem:ERRor:CLEar:REMOte.....                  | 572 |
| SYSTem:ERRor:DISPlay.....                       | 568 |
| SYSTem:ERRor:LIST?.....                         | 572 |
| SYSTem:ERRor[:NEXT]?.....                       | 573 |
| SYSTem:FIRMware:UPDate.....                     | 573 |
| SYSTem:FORMat:IDENT.....                        | 573 |
| SYSTem:FREQuency?.....                          | 926 |
| SYSTem:IDENTify:FACTory.....                    | 569 |
| SYSTem:IDENTify[:STRing].....                   | 569 |
| SYSTem:KLOCK.....                               | 569 |
| SYSTem:LANGUage.....                            | 569 |
| SYSTem:LXI:INFO.....                            | 569 |
| SYSTem:LXI:LANReset.....                        | 570 |
| SYSTem:LXI:MDEscription.....                    | 570 |
| SYSTem:LXI:PASSword.....                        | 570 |
| SYSTem:PASSword:RESet.....                      | 576 |
| SYSTem:PASSword[:CENable].....                  | 576 |
| SYSTem:PRESet.....                              | 543 |
| SYSTem:PRESet:CHANnel[:EXEC].....               | 543 |
| SYSTem:PRESet:COMPAtible.....                   | 574 |
| SYSTem:PRESet:USER:CAL.....                     | 926 |
| SYSTem:REBoot.....                              | 525 |
| SYSTem:REVision:FACTory.....                    | 570 |
| SYSTem:SEQuencer.....                           | 531 |
| SYSTem:SETTings:UPDate.....                     | 926 |
| SYSTem:SHUTdown.....                            | 526 |
| SYSTem:TIME.....                                | 565 |
| SYSTem:TIME.....                                | 927 |
| TRACe:CLEar.....                                | 955 |
| TRACe:COPIY.....                                | 928 |
| TRACe:COPIY:MATH.....                           | 929 |
| TRACe[:DATA]:STIMulus[:ALL]?.....               | 957 |
| TRACe[:DATA]:RESPonse[:ALL]?.....               | 956 |
| TRIGger<Ch>[:SEQuence]:HOLDoff.....             | 931 |
| TRIGger<Ch>[:SEQuence]:LINK.....                | 931 |
| TRIGger<Ch>[:SEQuence]:MULTiple:HOLDoff.....    | 932 |
| TRIGger<Ch>[:SEQuence]:MULTiple:SLOPe<Num>..... | 932 |
| TRIGger<Ch>[:SEQuence]:MULTiple:SOURce.....     | 933 |
| TRIGger<Ch>[:SEQuence]:SLOPe.....               | 934 |
| TRIGger<Ch>[:SEQuence]:SOURce.....              | 934 |

# 12 Troubleshooting

## 12.1 Error Messages and Troubleshooting

### 12.1.1 Errors during Firmware Operation

An error generally causes the analyzer to display a tooltip across the lower part of the screen. The tooltip provides a textual description of the error, e.g.:

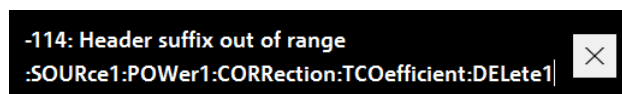

The errors can be divided into four categories:

- Remote errors (SCPI errors) can occur during the execution of a remote control program. They include an error code, followed by the short description of the error. Remote errors are specified and described in the SCPI standard; they are cleared upon \*CLS.
- Software errors (setting errors) can occur, e.g., if numeric entries in an analyzer dialog are incompatible with each other or with the current analyzer state. These errors are self-explanatory and easy to correct.
- Hardware errors indicate an incorrect hardware state. Some of the hardware errors cause the instrument to be switched off to avoid damage. Hardware errors with possible causes and remedies are listed in the following sections.
- Exceptions indicate anomalous or exceptional events that were not properly handled by the R&S ZNL/ZNLE firmware.



#### Troubleshooting SCPI errors

A misspelled command header causes SCPI error -113, "Undefined header;..."; a misspelled parameter causes SCPI error -141, "Invalid character data;...". The GPIB explorer provides a list of all supported commands and their character data parameters; see [Chapter 11.4.3, "The IECWIN Tool"](#), on page 580.

#### Hardware error categories

Hardware errors can be detected at various stages of the start-up or measurement procedure.

- Configuration errors occur on start-up of the analyzer, e.g. if a hardware module or configuration file cannot be detected. Configuration errors cause an entry in the error log.
- Asynchronous errors can occur any time while the analyzer is operating. The analyzer is checked periodically for asynchronous errors.

- Measurement errors are due to inadmissible hardware settings and states during the measurement process.

### 12.1.1.1 Asynchronous Errors

Asynchronous errors can occur any time while the analyzer is operating. The analyzer is checked periodically for asynchronous errors. Many of these errors also cause an entry in the status reporting system.

| Error                                  | Description                                                                                                                                                                                                                                                                                                                                                                                                                                                                 | Remedy                                                                              | Bit no.*) |
|----------------------------------------|-----------------------------------------------------------------------------------------------------------------------------------------------------------------------------------------------------------------------------------------------------------------------------------------------------------------------------------------------------------------------------------------------------------------------------------------------------------------------------|-------------------------------------------------------------------------------------|-----------|
| Instrument temperature is too high     | The analyzer detects that the instrument temperature is too high. After three warnings, the analyzer is shut down.                                                                                                                                                                                                                                                                                                                                                          | Reduce ambient temperature, keep ventilation holes of the casing unobstructed.      | 7         |
| Receiver overload protection tripped   | The analyzer detects an excessive input level at one of the ports.<br>If this condition persists, all internal and external generators are switched off ("RF Off").                                                                                                                                                                                                                                                                                                         | Reduce RF input level at the port.<br>Check amplifiers in the external test setup.  | 3         |
| Reference frequency lock failure       | With external reference signal (System – External Reference active) or internal high precision clock, the reference oscillator is phase locked to a 10 MHz signal. The message appears when this phase locked loop (PLL) fails.                                                                                                                                                                                                                                             | For external reference: check frequency and level of the supplied reference signal. | 1         |
| Converter clock frequency lock failure | The clock generator for the AD converter clock is phase locked to the reference oscillator. The message appears when this PLL fails.                                                                                                                                                                                                                                                                                                                                        | –                                                                                   | –         |
| Oven cold                              | With OXCO option-B4, the oven temperature is too low.                                                                                                                                                                                                                                                                                                                                                                                                                       | Wait until the oven has been heated up                                              | 8         |
| Internal communication error           | A serious unexpected disturbance was observed (e.g. due to ESD).<br>The firmware resets all hardware components to ensure proper instrument functioning and restores the user settings to the state before the event.<br>Finally, it indicates the foregone hardware reset by an information popup "Hardware communication problem detected. Hardware was reset. Measurement data of this sweep may be incorrect. Please contact Rohde & Schwarz if this problem persists." | If this error is raised repeatedly, please contact Rohde & Schwarz service.         | 6         |

\*) The following bits in the "[STATus:QUESTIONable:INTEGRity:HARDware](#)" on page 590 register are set when the error occurs.

### 12.1.1.2 Errors during Measurement

The following errors are due to inadmissible hardware settings and states during the measurement process. Some of the errors also cause an entry in the status reporting system.

| Error                                           | Description                                                                                                                                                                       | Remedy                                                                                                                                                                              | Bit no.*) |
|-------------------------------------------------|-----------------------------------------------------------------------------------------------------------------------------------------------------------------------------------|-------------------------------------------------------------------------------------------------------------------------------------------------------------------------------------|-----------|
| Unstable level control at port <i>              | The analyzer detects an excessive source level at one of the ports. The signal is turned off and the sweep halted.                                                                | Check signal path for the wave a <sub>i</sub> , especially check external components. Then press "Channel > Sweep > Sweep Control > Restart Sweep".                                 | 9         |
| Problem concerning external power meter Pmet<i> | An external power meter has been configured, however, it cannot be controlled or provides error messages. If several power meters cause problems, the lowest number is indicated. | Check whether the power meter is properly connected and switched on. Check the GPIB address; exclude address conflicts when using several external power meters or other equipment. | 11        |
| Time grid too close                             | The sweep points for a time sweep are too close, the analyzer cannot process the measurement data until the next sweep point starts.                                              | Increase stop time, reduce no. of points, increase IF bandwidth. If possible reduce number of partial measurements, e.g. by restricting the number of ports measured.               | 12        |
| Port <i> output power unlevelled                | The level control is unsettled or unstable, possibly due to an external disturbing signal.                                                                                        | Change generator level at the port; check external components.                                                                                                                      | 2         |

\*) The following bits in the `STATUS:QUESTIONABLE:INTEGRITY:HARDWARE` register are set when the error occurs.

### 12.1.2 Errors during Firmware Installation/Update

During firmware installation or update, if the installer encounters an error, the update is canceled and the analyzer firmware is rolled back to its previous state.

## 12.2 System Recovery

### To restore the original operating system image and firmware

1. Open the Windows control panel.
2. Select "Update & Security" > "Recovery" > "Restart Now".  
The "R&S Recovery Environment" starts.
3. In the "R&S Recovery Environment", select "Factory Default Restore".  
The default image is restored.
4. Reboot the instrument.

After the default image is restored, upgrade to the desired firmware version (see [Chapter 7.4.4, "Firmware Updates"](#), on page 132).

## 12.3 Collecting Information for Support

If problems occur, the instrument generates error messages which in most cases will be sufficient for you to detect the cause of an error and find a remedy.

In addition, our customer support centers are there to assist you in solving any problems that you may encounter with your R&S ZNL/ZNLE. We will find solutions more quickly and efficiently if you provide us with the information listed below.

- **Windows Event Log Files**

Windows records important actions of applications and the operating system in event logs. You can create event log files to summarize and save the existing event logs (see ["To create Windows event log files"](#) on page 1006).

- **System Configuration:** The "System Configuration" dialog box (in the "Setup" menu) provides information on:

- **Hardware Info:** hardware assemblies
- **Versions and Options:** the status of all software and hardware options installed on your instrument
- **System Messages:** messages on any errors that may have occurred

An .xml file with information on the system configuration ( "Device Footprint" ) can be created automatically (using the `DIAGnostic:SERvice:SIInfo` command or as described in ["To collect the support information"](#) on page 1006).

- **Error Log:** The `RSError.log` file (in the

`C:\Program Files\Rohde-Schwarz\Vector Network Analyzer\ZNL\log` directory) contains a chronological record of errors.

- **Support file:** a \*.zip file with important support information can be created automatically (in the

`C:\Program Files\Rohde-Schwarz\Vector Network Analyzer\ZNL\user` directory). The \*.zip file contains the system configuration information ( "Device Footprint" ), the current eeprom data and a screenshot of the screen display.

See also [Chapter 7.5.1, "R&S Support Information"](#), on page 136.

### To collect the support information

1. Press the [Setup] key.
2. Select "Service" > "R&S Support" and then "Create R&S Support Information" .

The file is stored as

```
C:\Program Files\Rohde-Schwarz\Vector Network Analyzer\ZNL\
user\

```

For example

```
C:\Program Files\Rohde-Schwarz\Vector Network Analyzer\ZNL\
user\ZNL3__20160803_145113.zip
```

### To create Windows event log files



1. Select the "Windows Start Button" in the bottom left corner.

2. Enter *Event Viewer* and select "Enter".
3. Select and expand "Windows Logs" in the "Console Tree".
4. Right-click on each subsection and select "Save All Events As...".

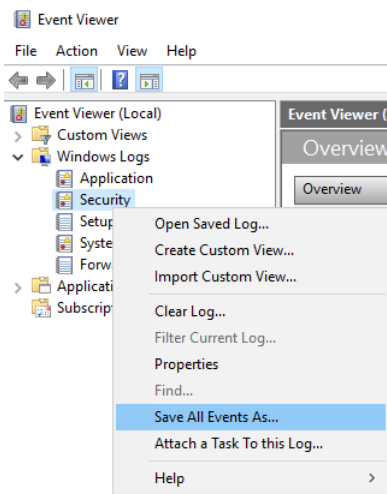

*Figure 12-1: Event Viewer*

5. Enter a file name and select "Save"

Collect the error information and attach it to an email in which you describe the problem. Send the email to the customer support address for your region as listed in [Chapter 12.4, "Contacting Customer Support"](#), on page 1007.



### **Packing and transporting the instrument**

If the instrument needs to be transported or shipped, observe the notes described in [Chapter 13, "Transporting"](#), on page 1009.

## **12.4 Contacting Customer Support**

### **Technical support – where and when you need it**

For quick, expert help with any Rohde & Schwarz product, contact our customer support center. A team of highly qualified engineers provides support and works with you to find a solution to your query on any aspect of the operation, programming or applications of Rohde & Schwarz products.

### **Contact information**

Contact our customer support center at [www.rohde-schwarz.com/support](http://www.rohde-schwarz.com/support), or follow this QR code:



*Figure 12-2: QR code to the Rohde & Schwarz support page*



# 13 Transporting

## Lifting and carrying

See:

- ["Lifting and carrying the product"](#) on page 13
- [Chapter 4.1.1, "Lifting and Carrying"](#), on page 24.

## Packing

Use the original packaging material. It consists of antistatic wrap for electrostatic protection and packing material designed for the product.

If you do not have the original packaging, use similar materials that provide the same level of protection.

## Securing

When moving the product in a vehicle or using transporting equipment, make sure that the product is properly secured. Only use items intended for securing objects.

## Transport altitude

Unless otherwise specified in the data sheet, the maximum transport altitude without pressure compensation is 4500 m above sea level.

# 14 Maintenance, Storage, Transport and Disposal

The product does not require regular maintenance. It only requires occasional cleaning. It is however advisable to check the nominal data from time to time.

## 14.1 Cleaning

How to clean the product is described in "[Cleaning the product](#)" on page 15.

Do not use any liquids for cleaning. Cleaning agents, solvents (thinners, acetone), acids and bases can damage the front panel labeling, plastic parts and display.

## 14.2 Changing Fuses

If the battery option R&S FPL1-B31 is installed (**R&S ZNL only!**), an AC supply fuse is built into the AC power supply connector. Only use fuses of the type 5A T IEC60127-2/V (order no. 0099.6735.00). Such fuses are used for all of the specified nominal AC supply voltages.

If the R&S ZNL/ZNLE does not start, it is possible that a blown fuse is the cause. The fuse is located in the socket of the power supply.



1. **WARNING!** The fuse is part of the main power supply. Handling the fuse while the power is on can lead to electric shock.

Before changing the fuse:

- a) Set the switch on the power supply to position [0].
- b) Disconnect the R&S ZNL/ZNLE from the power source.

2. Pull out the fuse holder.
3. Check the condition of the fuse.
4. Replace the blown fuse. Only use a fuse of the specified type.

The fuse type and its characteristics are indicated next to the fuse holder.

5. Insert the fuse holder into the mains power inlet.

## 14.3 Handling Batteries

Safe handling of batteries is described in "[Handling batteries safely](#)" on page 15. Maintenance information is provided here.

Keep the batteries clean and dry. If the terminals become soiled, clean them with a dry, clean cloth.

### Charging batteries

Charge the battery before using it for the first time. Following a long storage period, it can be necessary to charge and discharge the battery several times to reach full capacity.

For details on charging batteries, see "[Charging batteries](#)" on page 29.

### Storing batteries

Ideally, store the battery in the product and follow the instructions in [Storage](#). Otherwise, observe the following rules:

- Prevent short-circuiting of the batteries, which can happen if batteries touch each other or come into contact with metallic objects in the storage container. As storage container, you can use the product packaging.
- Do not expose to direct sunlight.
- Store the battery at room temperature.
- Store the battery at a state of charge between 50 % and 70 %.

## 14.4 Storage

Protect the product against dust. Ensure that the environmental conditions, e.g. temperature range and climatic load, meet the values specified in the data sheet.

## 14.5 Transporting

### Lifting and carrying

See:

- "[Lifting and carrying the product](#)" on page 13
- [Chapter 4.1.1, "Lifting and Carrying"](#), on page 24.

### Packing

Use the original packaging material. It consists of antistatic wrap for electrostatic protection and packing material designed for the product.

If you do not have the original packaging, use similar materials that provide the same level of protection.

### Securing

When moving the product in a vehicle or using transporting equipment, make sure that the product is properly secured. Only use items intended for securing objects.

### Transport altitude

Unless otherwise specified in the data sheet, the maximum transport altitude without pressure compensation is 4500 m above sea level.

## 14.6 Disposal

Rohde & Schwarz is committed to making careful, ecologically sound use of natural resources and minimizing the environmental footprint of our products. Help us by disposing of waste in a way that causes minimum environmental impact.

### Disposing electrical and electronic equipment

A product that is labeled as follows cannot be disposed of in normal household waste after it has come to the end of its service life. Even disposal via the municipal collection points for waste electrical and electronic equipment is not permitted.



*Figure 14-1: Labeling in line with EU directive WEEE*

Rohde & Schwarz has developed a disposal concept for the eco-friendly disposal or recycling of waste material. As a manufacturer, Rohde & Schwarz completely fulfills its obligation to take back and dispose of electrical and electronic waste. Contact your local service representative to dispose of the product.

### Disposing batteries

A product that contains a battery cannot be disposed of in the normal household waste after it has come to the end of its service life. It is labeled as follows:



*Figure 14-2: Disposal information in line with EU battery directive*

Dispose of batteries as specified by the local waste disposal agency. Alternatively, you can contact the Rohde & Schwarz local service representative.

For information on returning batteries to Rohde & Schwarz subsidiaries, see "[Handling batteries safely](#)" on page 15.

# 15 Annexes

The following sections cover mostly hardware and service-related topics.

## 15.1 Manual Firmware Uninstallation and Installation

If not otherwise stated in the Release Notes of the new firmware, a firmware update can be performed from the GUI of the running firmware application. See [Chapter 7.4.4, "Firmware Updates"](#), on page 132.

Typically, also firmware downgrades can be performed this way. However, sometimes it is required to uninstall the current firmware and to install an alternative firmware manually. For instance, to downgrade the firmware from a version  $X \geq 1.22$  to a version  $Y < 1.22$ , it is required to uninstall firmware version X manually. Then, after a possible reboot of the instrument, firmware version Y can be installed by executing its installer.



### Administrator Rights

By default, Windows® User Account Control is enabled on the instrument to prevent unwanted system-wide changes. Hence you need administrator rights to install or uninstall a firmware.

#### How to uninstall the current firmware

1. Close the running firmware application:
  - a) Press the Windows system key to display the Windows taskbar.
  - b) In the Windows taskbar, tap and hold the application icon of the firmware to access its context menu.
  - c) Select "Close Window".

**Tip:** If a keyboard is connected to the instrument, simply press *Alt+F4* to close the application.
2. Open the "Apps and Features" Windows settings:
  - a) Open the Windows start menu and select the gear icon to launch the "Windows Settings" system app
  - b) In the "Windows Settings" window, select "Apps"

**Tip:** If a keyboard is connected to the instrument, type "apps" in the Windows search bar and select the "Apps and Features" search result.
3. In the "Apps and Features" list, locate the "R&S ZNL Network Analyzer x.xx" item,

**Tip:** If a keyboard is connected to the instrument, type "ZNL" in the search field above the list to filter the list.
4. Tap and hold the "R&S ZNL Network Analyzer x.xx" item, and select "Uninstall" from its context menu

5. Pass the Windows User Account Control dialog. As a standard Windows user, you have to enter an administrator name and password. Select "Yes" to proceed.
6. If requested by the uninstaller, perform a reboot.

After a possible reboot of the instrument, a new firmware can be installed by executing its installer.

## 15.2 System Recovery

To access the recovery functionality, open the Windows control panel, select "Update & Security" > "Recovery" > "Restart Now" and wait for the "R&S Recovery Environment" to start.

To restore the original operating system image and firmware, proceed as follows:

1. In the "R&S Recovery Environment" select "Factory Default Restore"
2. Wait for the reimaging process to complete
3. Reboot the instrument

After the restore, upgrade to the desired firmware version (see [Chapter 7.4.4, "Firmware Updates"](#), on page 132).

## 15.3 Interfaces and Connectors

This chapter provides a detailed description of the rear panel connectors of the R&S ZNL/ZNLE. An overview of the available front and rear panel is given in the Getting Started guide (see [Chapter 4.2, "Instrument Tour"](#), on page 39).

### 15.3.1 Rear Panel Connectors

The rear panel of the R&S ZNL/ZNLE provides various connectors for external devices and control signals.

#### 15.3.1.1 Aux. Port

25-pole D-Sub connector used as an input and output for low-voltage (3.3 V) TTL control signals. Some of the lines can be configured (see [CONTrol Commands](#) and [OUT-put Commands](#)).





The Aux. Port connector is part of option R&S FPL1-B5 "Additional Interfaces". This option is not available for the R&S ZNLE.

To use the Aux. Port as VNA User Port (see table below) this has to be selected in the "Add. Interfaces" tab of the "System Configuration" dialog.

**Table 15-1: VNA User Port: Pole Assignment**

| Pin No. | Name              | Input (I) or Output (O) | Function                                                                                                                                                                                                                                                                                                                                          |
|---------|-------------------|-------------------------|---------------------------------------------------------------------------------------------------------------------------------------------------------------------------------------------------------------------------------------------------------------------------------------------------------------------------------------------------|
| 1       | AGND              | -                       | Ground                                                                                                                                                                                                                                                                                                                                            |
| 2       | UC_EXT_TRG_IN     | I                       | External trigger 1 input, 5 V tolerant *)                                                                                                                                                                                                                                                                                                         |
| 3       | AGND              | -                       | Ground                                                                                                                                                                                                                                                                                                                                            |
| 4       | UC_BUSY           | O                       | Hardware measurement time                                                                                                                                                                                                                                                                                                                         |
| 5       | AGND              | -                       | Ground                                                                                                                                                                                                                                                                                                                                            |
| 6       | READY FOR TRIGGER | O                       | Measurement completed, ready for new trigger                                                                                                                                                                                                                                                                                                      |
| 7       | AGND              | -                       | Ground                                                                                                                                                                                                                                                                                                                                            |
| 8       | UC_CH_BIT0        | O                       | Channel bit 0;<br>see <code>CONTROL:AUXiliary:C[:DATA]</code> and <code>OUTPUT&lt;Ch&gt;:UPORT[:VALue]</code>                                                                                                                                                                                                                                     |
| 9       | UC_CH_BIT1        | O                       | Channel bit 1                                                                                                                                                                                                                                                                                                                                     |
| 10      | UC_CH_BIT2        | O                       | Channel bit 2                                                                                                                                                                                                                                                                                                                                     |
| 11      | UC_CH_BIT3        | O                       | Channel bit 3                                                                                                                                                                                                                                                                                                                                     |
| 12      | AGND              | -                       | Ground                                                                                                                                                                                                                                                                                                                                            |
| 13      | UC_PASS1          | O                       | Pass/fail result of limit check 1; TTL Out Pass 1 (see <a href="#">TTL1 Pass / TTL2 Pass</a> )                                                                                                                                                                                                                                                    |
| 14      | UC_PASS2          | O                       | Pass/fail result of limit check 2; TTL Out Pass 2                                                                                                                                                                                                                                                                                                 |
| 15      | AGND              | -                       | Ground                                                                                                                                                                                                                                                                                                                                            |
| 16      | UC_DRV_PORT1      | O                       | Used as drive ports ( <code>OUTPUT:UPORT:ECBits OFF</code> ) or channel bits ( <code>OUTPUT:UPORT:ECBits ON</code> ; default)<br>If used as drive ports, DRIVE PORT <i>i</i> is active while test port <i>i</i> is the source port.<br>If used as channel bits, the pin states can be defined using <code>OUTPUT&lt;Ch&gt;:UPORT[:VALue]</code> . |
| 17      | UC_DRV_PORT2      | O                       |                                                                                                                                                                                                                                                                                                                                                   |
| 18      | UC_DRV_PORT3      | O                       |                                                                                                                                                                                                                                                                                                                                                   |
| 19      | UC_DRV_PORT4      | O                       |                                                                                                                                                                                                                                                                                                                                                   |
| 20      | AGND              | -                       | Ground                                                                                                                                                                                                                                                                                                                                            |
| 21      | UC_EXT_GEN_TRG    | O                       | Control signal for external generator                                                                                                                                                                                                                                                                                                             |
| 22      | UC_EXT_GEN_BLANK  | I                       | Handshake signal from external generator                                                                                                                                                                                                                                                                                                          |
| 23      | AGND              | -                       | Ground                                                                                                                                                                                                                                                                                                                                            |
| 24      | UC_FOSW           | I                       | Control input A, 5 V tolerant                                                                                                                                                                                                                                                                                                                     |
| 25      | UC_TRG2           | I                       | External trigger 2 input, 5 V tolerant                                                                                                                                                                                                                                                                                                            |

\*) Feeding in the external trigger signal via the BNC connector Trigger In is equivalent. The minimum pulse width of the trigger signals is 1  $\mu$ s.

**Table 15-2: SA Aux. Port: Pole assignment**

| Pin      | Signal             | Description                                                                                                                                                                       |
|----------|--------------------|-----------------------------------------------------------------------------------------------------------------------------------------------------------------------------------|
| 1 to 11  | unused             |                                                                                                                                                                                   |
| 12       | GND                | Ground                                                                                                                                                                            |
| 13       | +5 V / max. 250 mA | Supply voltage for external circuits                                                                                                                                              |
| 14 to 19 | I/O_<no.>          | Control lines for user ports (see user manual)                                                                                                                                    |
| 20       | unused             |                                                                                                                                                                                   |
| 21       | READY FOR TRIGGER  | Signal indicating that the instrument is ready to receive a trigger signal.<br>The signal polarity is configurable (see <a href="#">"Wait for Trigger Polarity"</a> on page 135). |
| 22 to 25 | unused             |                                                                                                                                                                                   |



### EMI Suppression

Use only double shielded cables or disconnect the input pins of the Aux. Port connector to avoid spurious input signals which may cause undesirable events.

This is of particular importance for the external trigger input (pin no. 2) if the Trigger In input is used.

## 15.3.2 GPIB Interface

The R&S ZNL/ZNLE can be equipped with a GPIB (IEC/IEEE) bus interface (option R&S FPL1-B10). The interface connector labeled "GPIB" is located on the rear panel of the instrument. The GPIB bus interface is intended for remote control of the R&S ZNL/ZNLE from a controller.

### Characteristics of the interface

- 8-bit parallel data transfer
- Bidirectional data transfer
- Three-line handshake
- High data transfer rate of max. 1 MByte/s
- Up to 15 devices can be connected
- Wired OR if several instruments are connected in parallel



### Pin assignment

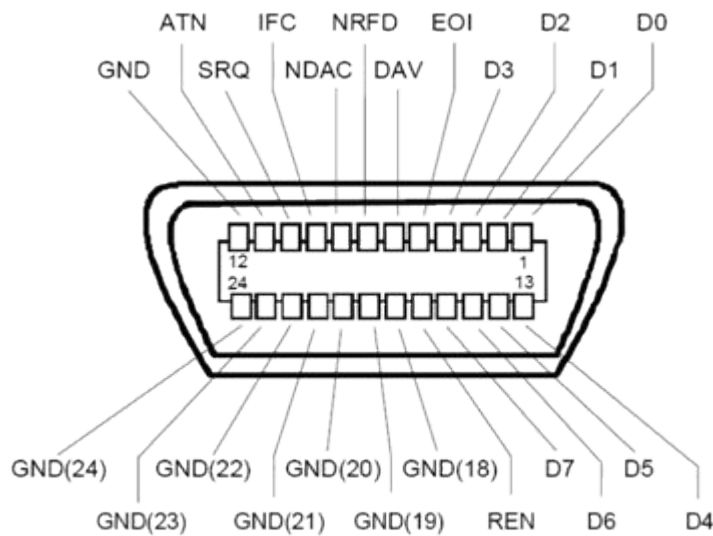

### Bus lines

- Data bus with 8 lines D0 to D7:  
The transmission is bit-parallel and byte-serial in the ASCII/ISO code. D0 is the least significant bit, D7 the most significant bit.
- Control bus with five lines:  
**IFC** (Interface Clear): active LOW resets the interfaces of the instruments connected to the default setting.  
**ATN** (Attention): active LOW signals the transmission of interface messages, inactive HIGH signals the transmission of device messages.  
**SRQ** (Service Request): active LOW enables the connected device to send a service request to the controller.  
**REN** (Remote Enable): active LOW permits switchover to remote control.  
**EOI** (End or Identify): has two functions in connection with ATN:
  - ATN=HIGH active LOW marks the end of data transmission.
  - ATN=LOW active LOW triggers a parallel poll.
- Handshake bus with three lines:  
**DAV** (Data Valid): active LOW signals a valid data byte on the data bus.  
**NRFD** (Not Ready For Data): active LOW signals that one of the connected devices is not ready for data transfer.  
**NDAC** (Not Data Accepted): active LOW signals that the instrument connected is accepting the data on the data bus.

The R&S ZNL/ZNLE provides several functions to communicate via GPIB bus. They are described in the following sections.

### 15.3.2.1 Interface Functions

Instruments which can be controlled via GPIB bus can be equipped with different interface functions. The interface functions for the R&S ZNL/ZNLE are listed in the following table.

| Control character | Interface function                                                                      |
|-------------------|-----------------------------------------------------------------------------------------|
| SH1               | Handshake source function (source handshake), full capability                           |
| AH1               | Handshake sink function (acceptor handshake), full capability                           |
| L4                | Listener function, full capability, de-addressed by MTA.                                |
| T6                | Talker function, full capability, ability to respond to serial poll, deaddressed by MLA |
| SR1               | Service request function (Service Request), full capability                             |
| PP1               | Parallel poll function, full capability                                                 |
| RL1               | Remote/Local switch over function, full capability                                      |
| DC1               | Reset function (Device Clear), full capability                                          |
| DT1               | Trigger function (Device Trigger), full capability                                      |

### 15.3.2.2 Interface Messages

Interface messages are transmitted to the instrument on the data lines, with the attention line being active (LOW). They serve to communicate between controller and instrument.

#### Universal commands

Universal commands are encoded in the range 10 through 1F hex. They are effective for all instruments connected to the bus without previous addressing.

| Command                     | QuickBASIC command              | Effect on the instrument                                                                                                                                          |
|-----------------------------|---------------------------------|-------------------------------------------------------------------------------------------------------------------------------------------------------------------|
| DCL<br>(Device Clear)       | IBCMD (controller %, CHR\$(20)) | Aborts the processing of the commands just received and sets the command processing software to a defined initial state. Does not change the instrument settings. |
| IFC<br>(Interface Clear)    | IBSIC (controller%)             | Resets the interfaces to the default setting.                                                                                                                     |
| LLO<br>(Local Lockout)      | IBCMD (controller %, CHR\$(17)) | The LOC/IEC ADDR key is disabled.                                                                                                                                 |
| SPE<br>(Serial Poll Enable) | IBCMD (controller %, CHR\$(24)) | Ready for serial poll                                                                                                                                             |

| Command                            | QuickBASIC command              | Effect on the instrument       |
|------------------------------------|---------------------------------|--------------------------------|
| SPD<br>(Serial Poll Disable)       | IBCMD (controller %, CHR\$(25)) | End of serial poll             |
| PPU<br>(Parallel Poll Unconfigure) | IBCMD (controller %, CHR\$(21)) | End of the parallel-poll state |

### Addressed commands

Addressed commands are encoded in the range 00 through 0F hex. They are only effective for instruments addressed as listeners.

| Command                          | QuickBASIC command     | Effect on the instrument                                                                                                                                         |
|----------------------------------|------------------------|------------------------------------------------------------------------------------------------------------------------------------------------------------------|
| GET<br>(Group Execute Trigger)   | IBTRG (device%)        | Triggers a previously active device function (e.g. a sweep). The effect of the command is the same as with that of a pulse at the external trigger signal input. |
| GTL<br>(Go to Local)             | IBLOC (device%)        | Transition to the "Local" state (manual control)                                                                                                                 |
| PPC<br>(Parallel Poll Configure) | IBPPC (device%, data%) | Configures the instrument for parallel poll. Additionally, the QuickBASIC command executes PPE/PPD.                                                              |
| SDC<br>(Selected Device Clear)   | IBCLR (device%)        | Aborts the processing of the commands just received and sets the command processing software to a defined initial state. Does not change the instrument setting. |

#### 15.3.2.3 Instrument Messages

Instrument messages (commands) are transferred on the data lines of the GPIB bus while the ATN line is not active. ASCII code is used.

Structure and syntax of the instrument messages are described in the [Chapter 11, "Command Reference"](#), on page 520. This chapter also provides a detailed description of all messages implemented by the analyzer.

## 15.4 Maintenance

The R&S ZNL/ZNLE vector network analyzer does not require any special maintenance.

For our support center address and a list of useful R&S contact addresses, refer to the "Contact" page at the beginning of the Help system.

### 15.4.1 Cleaning

---

**⚠ WARNING****Risk of electric shock**

If moisture enters the casing, for example if you clean the instrument using a moist cloth, contact with the instrument can lead to electric shock. Before cleaning the instrument other than with a dry cloth, make sure that the instrument is switched off and disconnected from all power supplies.

---

**NOTICE****Instrument damage caused by cleaning agents**

Cleaning agents contain substances such as solvents (thinners, acetone, etc.), acids, bases, or other substances. Solvents can damage the front panel labeling, plastic parts, or screens, for example.

Never use cleaning agents to clean the outside of the instrument. Use a soft, dry, lint-free dust cloth instead.

---

**NOTICE****Risk of instrument damage due to obstructed fans**

If the instrument is operated in dusty areas, the fans become obstructed by dust or other particles over time. Check and clean the fans regularly to ensure that they always operate properly. If the instrument is run with obstructed fans for a longer period, the instrument overheats, which can disturb the operation and even cause damage.

---

1. Clean the outside of the instrument using a soft, dry, lint-free dust cloth.
2. Check and clean the fans regularly to ensure that they always operate properly.

### 15.4.2 Storing and Packing the Instrument

The vector network analyzer can be stored at the temperature range quoted in the data sheet. When it is stored for a longer period of time, the unit must be protected against dust.

# Glossary: Frequently Used Terms

## A

**Active channel:** Channel belonging to the active trace. The active channel is highlighted in the channel list below the diagram. The active channel is not relevant in remote control where each channel can contain an active trace.

**Active marker:** Marker that can be changed using the settings of the Marker menu (Delta Mode, Ref. Mkr -> Mkr, Mkr Format). The active marker is also used for the Marker Functions. It appears in the diagram with an enlarged marker symbol and font size and with a dot placed in front of the marker line in the info field.

**Active menu:** The menu containing the last executed command. If the softkey bar is displayed (Display - Config./View - Softkey Labels on), then the active menu is indicated on top of the softkey bar.

**Active trace (manual control):** Trace that is selected to apply the settings in the Trace menu. The active trace is highlighted in the trace list of the active diagram area. It can be different from the active trace in remote control.

**Active trace (remote control):** One trace of each channel that has been selected as the active trace (`CALCulate<Ch>:PARAMeter:SElect <trace name>`). Many commands (e.g. `TRACE . . .`) act on the active trace. It can be different from the active trace in manual control.

## C

**Cal pool:** The cal pool is a collection of correction data sets (cal groups) that the analyzer stores in a common directory. Cal groups in the pool can be applied to different channels and channel setups.

**Calibration:** The process of removing systematic errors from the measurement (system error correction). See also TOSM, TOM, TRM, TRL, TNA...

**Calibration kit:** Set of physical calibration standards for a particular connector family.

**Calibration standard:** Physical device that has a known or predictable magnitude and phase response within a given frequency range. Calibration standards are grouped into several types (open, through, match,...) corresponding to the different input quantities for the analyzer's error models.

**Calibration unit:** Integrated solution for automatic calibration of multiple ports (accessories R&S ZV-Zxx, R&S ZN-Z5x and R&S ZN-Z15x). The unit contains calibration standards that are electronically switched when a calibration is performed.

**Channel:** A channel contains hardware-related settings to specify how the network analyzer collects data. Each channel is stored in an independent data set. The channel

settings complement the definitions of the Trace menu; they apply to all traces assigned to the channel.

**Channel Setup:** A channel setup comprises a set of VNA diagram areas with all displayed information that can be stored to an instrument settings file (\*.df1). Each channel setup is displayed in an independent tab.

**Compression point:** The x-dB compression point of an S-parameter or ratio is the stimulus signal level where the magnitude of the measured quantity has dropped by x dB compared to its value at small stimulus signal levels (small-signal value).

**Confirmation dialog box:** Standard dialog box that pops up to display an error message or a warning. The current action can be either continued (OK) or cancelled (Cancel) on closing the dialog box.

**Crosstalk:** The occurrence of a signal at the receive port of the analyzer which did not travel through the test setup and the DUT but leaks through other internal paths. Crosstalk causes an isolation error in the measurement which can be corrected by means of a calibration.

**CW frequency:** Continuous Wave frequency; fixed stimulus frequency used in Power, CW Time and CW Mode sweeps.

## D

**Data trace:** Trace filled with measurement data and updated after each sweep (dynamic trace).

**Diagram area:** Rectangular portion of the screen used to display traces. Diagram areas are arranged in windows; they are independent of trace and channel settings.

**Directivity error:** Measurement error caused by a coupler or bridge in the analyzer's source port causing part of the generated signal to leak through the forward path into the receive path instead of being transmitted towards the DUT. The directivity error can be corrected by means of a full one port calibration or one of the two-port calibration methods (except normalization).

**Discrete marker:** The stimulus value of a discrete marker always coincides with a sweep point so that the marker does not show interpolated measurement values.

**DUT:** Device under test; generic term for any electrical device or circuit which the vector network analyzer can measure. Typical DUTs are filters, amplifiers, or mixers.

## E

**Excursion:** Difference between the response values at a local maximum (minimum) of the trace and at the two closest local minima (maxima) to the left and to the right.

**Extrapolation:** Calculation of a numeric value for a new sweep point outside the original sweep range from the numeric values of the existing sweep points. The analyzer can extrapolate calibration data, transmission coefficients etc. in order to extend the sweep range. If not otherwise stated, the numeric value of the first (last) sweep point is assigned to all new points below (above) the original sweep range. See also --> interpolation.

## F

**Forward:** A measurement on a two-port DUT is said to be in forward direction if the source signal (stimulus) is applied to port 1 of the DUT.

## H

**Harmonic:** Integer multiple of the fundamental frequency. The fundamental is the first harmonic, the nth harmonic is n times the frequency of the fundamental.

**Harmonic distortion:** The production of harmonic frequencies (harmonics) by an electronic system when a signal is applied at the input.

**Harmonic grid:** A set of equidistant frequency points  $f_i$  ( $i = 1 \dots n$ ) with spacing  $\Delta(f)$  and the additional condition that  $f_1 = \Delta(f)$ . A harmonic grid is required for low pass time domain transforms.

## I

**Intercept point:** Fictitious lower-tone DUT input/output level where the intermodulation suppression (-->) for a given intermodulation product reaches 0 dB.

**Intermodulation measurement:** Measurement where the DUT is supplied with two RF signals of equal power but different frequencies termed the upper and lower tone. The analyzer measures the frequency-converting behavior of the DUT (--> intermodulation product).

**Intermodulation product:** Special type of emissions of a nonlinear DUT that is supplied with a two-tone RF signal (--> intermodulation measurement). The intermodulation products occur at frequencies which correspond to sums and differences of the upper and lower tone frequencies and their integer multiples.

**Intermodulation suppression:** The ratio of the power of an --> intermodulation product to the power of the lower tone fundamental wave.

**Interpolation:** Calculation of a numeric value for a specific sweep point from the numeric values of the adjacent points. The analyzer can interpolate calibration data, transmission coefficients etc. in order to account for a modified set of sweep points. If not otherwise stated, linear interpolation is used. See also --> extrapolation.

**Isolation error:** Measurement error caused by a crosstalk between the source and receive port of the analyzer.

**L**

**Limit check:** Comparison of the measurement results with the limit lines and display of a pass/fail indication. An acoustic warning can be generated in addition if a limit is exceeded.

**Limit line:** A limit line is a set of data to specify the allowed range for some or all points of a trace. Typically, limit lines are used to check whether a DUT conforms to the rated specifications (conformance testing).

**Load match error:** Measurement error caused by a mismatch of the analyzer's receive (load) port causing part of the signal transmitted through the DUT to be reflected off the receive port so that it is not measured there. The load match error can be corrected by means of a two-port calibration (except normalization).

**M**

**Marker:** Tool for selecting points on the trace and for numerical readout of measured data. A marker is displayed with a symbol (a triangle, a crossbar or a line) on the trace; its coordinates are shown in the marker info field.

**Mathematical trace:** Trace that is calculated according to a mathematical expression, e.g. the one defined in the Define Math dialog. The expression is a mathematical relation between constants and the data or memory traces of the active channel setup.

**Measurement point:** Result of the measurement at a specified stimulus value (frequency/power/time).

**Measurement result:** Set of all measurement points acquired in a measurement (e.g. a sweep). The measurement result is displayed in a diagram area and forms a trace.

**Memory trace:** Trace that is associated to a data trace and stored in the memory. Data traces and the associated memory traces share the same channel and scale settings. Alternatively, memory traces can be imported from a file.

**Mixer:** Device that converts an RF signal at one frequency into a signal at another frequency. The frequency that is to be shifted is applied at the RF input and the frequency shifting signal (from a local oscillator, LO) is applied to the RF mixer's LO port, resulting in an output signal at the mixer's Intermediate Frequency (IF) port.

**P**

**Partial measurement:** Measurement at a specified stimulus value maintaining definite hardware settings. Depending on the measurement type, several partial measurements may be needed to obtain a measurement point. A full n-port S-parameter measurement requires n partial measurements with n different drive ports.

**Peak:** Local maximum or local minimum (dip) on the trace. In the Trace - Search menu, it is possible to define a minimum excursion that both types of peaks must have to be considered valid.



**R**

**Reflection tracking error:** Frequency-dependent variation of the ratio of the reflected wave to the reference wave at a test port when an ideal reflection coefficient ( $= 1$ ) is measured. The reflection tracking error can be corrected by means of a reflection normalization or one of the more sophisticated calibration methods.

**Reverse:** A measurement on a two-port DUT is said to be in reverse direction if the source signal (stimulus) is applied to port 2 of the DUT.

**S**

**Source match error:** Measurement error caused by a mismatch of the analyzer's source port causing part of the signal reflected off the DUT to be reflected again off the source port so that it is not measured there. The source match error can be corrected by means of a full one-port calibration or a two-port calibration (except normalization).

**Stimulus value:** Value of the sweep variable (frequency/power/time/point number) where a measurement is taken. Also termed sweep point.

**Sweep:** Series of consecutive measurements taken at a specified sequence of stimulus values = series of consecutive measurement points.

**Sweep point:** Value of the sweep variable (stimulus value: frequency/power/time) where a measurement is taken.

**Sweep range:** Continuous range of the sweep variable (frequency/power/time) containing the sweep points where the analyzer takes measurements. In a Segmented Frequency sweep the sweep range can be composed of several parameter ranges or single points.

**Sweep segment:** Continuous frequency range or single frequency point where the analyzer measures at specified instrument settings (generator power, IF bandwidth etc.). In the Segmented Frequency sweep type the entire sweep range can be composed of several sweep segments.

**T**

**TNA:** A calibration type using a Through, a symmetric Network and an Attenuation standard. The properties of the Network and the Attenuation don't have to be known exactly. Like TRL and TRM, TNA is especially useful for DUTs in planar line technology.

**TOM:** A calibration type using three fully known standards (Through, Open, Match), recommended for 2-port measurements on coaxial systems.

**Topology:** Assignment of the physical ports of the VNA to the logical ports used for the measurement of mixed mode S-parameters (balance-unbalance conversion).

**TOSM:** A calibration type using a Through plus the one-port standards Open, Short, Match, to be connected to each calibrated port. Classical 12-term error model, also referred to as SOLT. See also UOSM.

**TRL:** A calibration type using the two-port standards Through and Line, which are both assumed to be ideally matched. Beyond that, the through must be lossless, and its length must be exactly known. Especially useful for DUTs in planar line technology.

**TRM:** A calibration type which requires a low-reflection, low-loss Through standard with an electrical length that may be different from zero, a Reflect, and a Match. Especially useful for DUTs in test fixtures.

**TSM:** A calibration type using three fully known standards (Through, Short, Match), recommended for 2-port measurements on coaxial systems.

## U

**UOSM:** A variant of TOSM calibration using an unknown but reciprocal Through standard. Especially for port combinations with different connector types.

## V

**VNA:** (Vector) Network Analyzer, in particular the R&S ZNL/ZNLE.

# Index

## Symbols

|                           |     |
|---------------------------|-----|
| *.csv file format .....   | 245 |
| *.limit .....             | 237 |
| *.ripple .....            | 238 |
| *.s<n>p file format ..... | 239 |
| *CLS .....                | 594 |
| *OPC (use) .....          | 591 |
| μ1 21 (softkey) .....     | 394 |
| μ2 21 (softkey) .....     | 394 |

## A

|                                         |      |
|-----------------------------------------|------|
| a1 Source Port 1 .....                  | 386  |
| a2 Source Port 2 .....                  | 386  |
| Active Diagram .....                    | 402  |
| Active Trace .....                      | 331  |
| Add Trace .....                         | 331  |
| Add Trace + Diagram .....               | 332  |
| Additional removable PC board .....     | 290  |
| Addressed command .....                 | 1018 |
| Adjust Time Gate .....                  | 501  |
| Admittance .....                        | 224  |
| Advanced (system settings) .....        | 145  |
| Agilent Mode .....                      | 474  |
| All Channels Continuous .....           | 328  |
| All Channels on Hold .....              | 328  |
| All Data & Func to <Destination> .....  | 338  |
| All Data to <Destination> .....         | 338  |
| All Partial Meas'ments .....            | 312  |
| All S-Params .....                      | 377  |
| Alphanumeric parameters .....           | 81   |
| Analog Demodulation                     |      |
| Application .....                       | 87   |
| Annexes .....                           | 1013 |
| Annotations                             |      |
| Hiding/restoring .....                  | 123  |
| Aperture .....                          | 230  |
| Aperture Points .....                   | 400  |
| Application cards .....                 | 20   |
| Application notes .....                 | 20   |
| Applications                            |      |
| Analog Demodulation .....               | 87   |
| Available .....                         | 86   |
| I/Q Analyzer .....                      | 87   |
| Noise Figure .....                      | 87   |
| Setting .....                           | 88   |
| Signal and Spectrum Analyzer mode ..... | 85   |
| Spectrum .....                          | 86   |
| VNA .....                               | 86   |
| Apply                                   |      |
| System error correction .....           | 466  |
| Arrow keys .....                        | 44   |
| ASCII (*.csv) file .....                | 245  |
| ATN .....                               | 1017 |
| Attention .....                         | 1017 |
| Auto Length .....                       | 502  |
| Auto Length and Loss .....              | 506  |
| Auto Power Setting for Cal Unit .....   | 142  |
| Auto Scale Diagram .....                | 302  |
| Auto Scale Trace .....                  | 302  |
| Autologin mechanism                     |      |
| Activating/Deactivating .....           | 174  |

|                               |      |
|-------------------------------|------|
| Automatic calibration .....   | 260  |
| Automatic Harmonic Grid ..... | 348  |
| Aux. Port .....               | 1014 |
| Connector .....               | 50   |
| Average .....                 | 308  |
| Average tab .....             | 308  |
| Averaging mode .....          | 309  |
| Auto .....                    | 309  |
| Flatten Noise .....           | 309  |
| Moving Average .....          | 309  |
| Reduce Noise .....            | 309  |
| Axis Pair .....               | 350  |

## B

|                                   |          |
|-----------------------------------|----------|
| b1 / a1 Source Port 1 .....       | 384      |
| b1 / a2 Source Port 2 .....       | 384      |
| b1 Source Port 1 .....            | 386      |
| b1 Source Port 2 .....            | 386      |
| b2 / a1 Source Port 1 .....       | 384      |
| b2 / a2 Source Port 2 .....       | 384      |
| b2 Source Port 1 .....            | 386      |
| b2 Source Port 2 .....            | 386      |
| Balanced port .....               | 228      |
| Balanced Ports dialog .....       | 379      |
| Predefined Config tab .....       | 380      |
| Reference Impedance tab .....     | 381      |
| User Config tab .....             | 380      |
| Band pass impulse .....           | 283      |
| Bandfilter search .....           | 204, 447 |
| Bandpass Ref to Max .....         | 449      |
| Bandpass Ref to Mkr .....         | 450      |
| Bandstop Ref to Max .....         | 450      |
| Bandwidth .....                   | 448      |
| Result Off .....                  | 451      |
| Search bandpass or bandstop ..... | 451      |
| Search Mode .....                 | 451      |
| Tracking .....                    | 451      |
| Bandpass .....                    | 204      |
| Bandpass (time gate) .....        | 350      |
| Bandstop .....                    | 204      |
| Bandwidth .....                   | 307      |
| Bandwidth (bandfilter) .....      | 204      |
| Bandwidth tab .....               | 307      |
| Selectivity .....                 | 307      |
| Basic instrument concepts .....   | 186      |
| Brochures .....                   | 19       |
| Buffered Sweep .....              | 980      |
| Bw Avg Power softtool .....       | 306      |
| Average tab .....                 | 308      |
| Bandwidth tab .....               | 307      |
| Power tab .....                   | 306      |

## C

|                                  |     |
|----------------------------------|-----|
| Cal Connector Types dialog ..... | 468 |
| Char. Imp. .....                 | 468 |
| Cutoff Freq. fc .....            | 469 |
| Line Type .....                  | 469 |
| Offset model .....               | 469 |
| Rel. Permittivity εr .....       | 469 |
| Cal group .....                  | 259 |

|                                    |               |  |  |
|------------------------------------|---------------|--|--|
| Cal Kit                            |               |  |  |
| Import                             | 464           |  |  |
| Selection                          | 464           |  |  |
| Cal kit file                       | 258           |  |  |
| Cal Kits                           |               |  |  |
| Calibration Setting wizard         | 463           |  |  |
| Cal softtool                       | 452           |  |  |
| Cal Unit                           |               |  |  |
| Calibration                        | 456           |  |  |
| Characterization                   | 456           |  |  |
| Calibrate all Channels             | 462           |  |  |
| Calibration                        | 248, 452, 982 |  |  |
| Cal Unit                           | 456           |  |  |
| Cal Unit Characterization          | 456           |  |  |
| Calibrate all Channels             | 462           |  |  |
| Frequency                          | 138           |  |  |
| Frequency MW                       | 139           |  |  |
| Frequency RF                       | 139           |  |  |
| Manual                             | 460           |  |  |
| Ports                              | 455, 462      |  |  |
| program example                    | 982           |  |  |
| Remote control                     | 559           |  |  |
| Results (remote control)           | 559           |  |  |
| RF                                 | 139           |  |  |
| Settings                           | 138           |  |  |
| Signal                             | 138           |  |  |
| Signal, as RF input                | 66            |  |  |
| Source port                        | 462           |  |  |
| Sweep diagrams                     | 459, 465      |  |  |
| Type                               | 456, 462      |  |  |
| Calibration (manual)               |               |  |  |
| Connector                          | 463           |  |  |
| Same Connector All Ports           | 464           |  |  |
| Same Gender All Ports              | 464           |  |  |
| Sweep                              | 465           |  |  |
| Calibration (system settings)      | 141           |  |  |
| Calibration certificate            | 20            |  |  |
| Calibration Frequency MW           | 560           |  |  |
| Calibration kit                    | 253           |  |  |
| Calibration Kits dialog            | 470           |  |  |
| Add cal kit                        | 471           |  |  |
| Available Cal Kits                 | 471           |  |  |
| Connector Type                     | 471           |  |  |
| Copy cal kit                       | 471           |  |  |
| Delete cal kit                     | 471           |  |  |
| Export Cal Kit                     | 472           |  |  |
| Import Cal Kit                     | 472           |  |  |
| Standards                          | 471           |  |  |
| Calibration labels                 |               |  |  |
| system error correction            | 260           |  |  |
| Calibration Manager dialog         | 481           |  |  |
| Add                                | 481           |  |  |
| Add All                            | 481           |  |  |
| Apply                              | 481           |  |  |
| Apply to All                       | 481           |  |  |
| Channel and calibration properties | 482           |  |  |
| Channel State                      | 481           |  |  |
| Delete from Pool                   | 482           |  |  |
| Pool                               | 482           |  |  |
| Preset User Cal                    | 482           |  |  |
| Replace                            | 481           |  |  |
| Resolve Pool Link                  | 482           |  |  |
| Calibration pool                   | 259           |  |  |
| Calibration Setting wizard         | 460           |  |  |
| Apply                              | 466           |  |  |
| Cal Kit                            | 464           |  |  |
| Calibration                        | 464           |  |  |
| Connectors and Cal Kits            | 463           |  |  |
| Ports and Type                     | 461           |  |  |
| Calibration standard               | 253           |  |  |
| Calibration types                  | 249           |  |  |
| Calibration unit                   | 260           |  |  |
| Calibration Unit                   |               |  |  |
| Default Port Assignment            | 458           |  |  |
| Detect Port Assignment             | 458, 460      |  |  |
| Detect Ports & Start Cal           | 459           |  |  |
| Calibration Unit wizard            | 454           |  |  |
| Calibration Type                   | 456           |  |  |
| Cartesian diagram                  | 210           |  |  |
| CENTER                             | 191           |  |  |
| Center (bandfilter)                | 204           |  |  |
| Center = Marker                    | 435           |  |  |
| Center Frequency                   | 296           |  |  |
| Channel                            | 187, 332      |  |  |
| programming examples               | 961           |  |  |
| Channel Bits                       | 489           |  |  |
| Channel Bits (system settings)     |               |  |  |
| Decimal                            | 489           |  |  |
| Pin 16 - 19                        | 490           |  |  |
| Channel Info                       | 408           |  |  |
| Channel Manager dialog             | 486           |  |  |
| Add channel                        | 486           |  |  |
| Channel table                      | 486           |  |  |
| Delete channel                     | 486           |  |  |
| Channel properties                 | 482           |  |  |
| Channel settings                   | 205           |  |  |
| Channel Setup                      |               |  |  |
| Creating (remote)                  | 527, 529      |  |  |
| Deleting (remote)                  | 527           |  |  |
| Duplicating (remote)               | 526           |  |  |
| Querying (remote)                  | 528           |  |  |
| Renaming (remote)                  | 528           |  |  |
| Replacing (remote)                 | 527           |  |  |
| Selecting (remote)                 | 529           |  |  |
| Channel Setup bar                  |               |  |  |
| Hiding/restoring                   | 123           |  |  |
| channel setup settings             |               |  |  |
| Presetting                         | 96            |  |  |
| Channel Setups                     |               |  |  |
| Duplicating                        | 90            |  |  |
| New                                | 89            |  |  |
| Replacing                          | 90            |  |  |
| Sequential operation               | 90            |  |  |
| Trying out                         | 63            |  |  |
| Channel softtool                   | 483           |  |  |
| Channel Bits tab                   | 489           |  |  |
| Channels tab                       | 483           |  |  |
| Mode tab                           | 487           |  |  |
| Channels tab                       |               |  |  |
| Active Channel                     | 484           |  |  |
| Channel Manager                    | 486           |  |  |
| Channel On                         | 485           |  |  |
| Controls                           | 483           |  |  |
| Copy Channel                       | 484           |  |  |
| Copy Channel + Diagram             | 485           |  |  |
| Delete Channel                     | 485           |  |  |
| Fixture Simulator                  | 485           |  |  |
| New Channel                        | 484           |  |  |
| New Channel + Diagram              | 485           |  |  |
| Characterization                   |               |  |  |
| Cal Unit                           | 456           |  |  |
| Characterization Data              | 477           |  |  |
| Characterization wizard            | 477           |  |  |
| Test Port Assignment               | 478           |  |  |

|                                    |               |
|------------------------------------|---------------|
| Characterize Cal Unit dialog ..... | 475           |
| Authentication .....               | 476           |
| Set Password .....                 | 476           |
| Chirp z-transformation .....       | 282           |
| Circle limit .....                 | 235           |
| Circle Test .....                  | 424           |
| Clear Test .....                   | 427           |
| Define circle .....                | 427           |
| Draw Circle .....                  | 427           |
| Limit Check .....                  | 425           |
| Limit Fail Beep .....              | 426           |
| Show Limit Circle .....            | 425           |
| Cleaning .....                     | 1020          |
| Clear status                       |               |
| Remote .....                       | 521           |
| Closing                            |               |
| Channel Setups (remote) .....      | 527           |
| Colors                             |               |
| Display .....                      | 125           |
| Editing .....                      | 125           |
| Editing (remote) .....             | 565           |
| Print .....                        | 126           |
| Printing .....                     | 125           |
| Command reference .....            | 597           |
| Command sequence                   |               |
| Remote .....                       | 524           |
| Commands                           |               |
| GBIP, addressed .....              | 155           |
| GBIP, universal .....              | 155           |
| Tracking .....                     | 160           |
| Comment                            |               |
| Screenshots .....                  | 108           |
| Softkey .....                      | 108           |
| Common mode .....                  | 227, 228      |
| Common Mode .....                  | 382           |
| Compatibility                      |               |
| FSV .....                          | 161           |
| GPIB .....                         | 161           |
| Mode .....                         | 161           |
| Compatibility mode                 |               |
| Sweep Active Channel .....         | 330           |
| Sweep All Channels .....           | 330           |
| Computer name .....                | 158           |
| CONDition .....                    | 583, 584      |
| Connector                          |               |
| AC power supply .....              | 47            |
| Aux. Port .....                    | 50            |
| Display Port .....                 | 51            |
| DVI .....                          | 51            |
| GPIB interface .....               | 48            |
| Headphones .....                   | 50            |
| IF/VIDEO/DEMODO .....              | 49            |
| LAN .....                          | 51            |
| Noise source control .....         | 49            |
| Power sensor .....                 | 51            |
| Ref. In .....                      | 48            |
| Ref. Out .....                     | 48            |
| RF Input 50Ω .....                 | 45            |
| Trigger In .....                   | 49            |
| USB .....                          | 41, 51        |
| Connectors .....                   | 1014          |
| Calibration Setting wizard .....   | 463           |
| Context menu .....                 | 206           |
| Context menus .....                | 78            |
| Continuous Sequencer               |               |
| Softkey .....                      | 93            |
| Continuous sweep .....             | 327           |
| Control bus .....                  | 1017          |
| Control lines (GPIB bus) .....     | 1016          |
| Conventions                        |               |
| SCPI commands .....                | 520           |
| Copying                            |               |
| Channel Setup (remote) .....       | 526           |
| Couple Active Trace .....          | 304           |
| Couple All Traces .....            | 304           |
| Customer support .....             | 1007          |
| CW Frequency .....                 | 297           |
| CW Mode sweep .....                | 314           |
| <b>D</b>                           |               |
| Data & Func to <Destination> ..... | 336           |
| Data bus (GPIB) .....              | 1016          |
| Data flow .....                    | 192           |
| Data sheets .....                  | 19            |
| Data to <Destination> .....        | 336           |
| Data Valid .....                   | 1017          |
| Date                               |               |
| Format .....                       | 122           |
| Hiding/restoring .....             | 123           |
| Instrument setting .....           | 121           |
| Date and Time                      |               |
| Printing .....                     | 109           |
| DAV .....                          | 1017          |
| dB Mag .....                       | 395           |
| DC Value .....                     | 348           |
| DCL .....                          | 155, 1018     |
| DCL, SDC .....                     | 594           |
| Decouple Active Trace .....        | 304           |
| Decouple All Traces .....          | 304           |
| Deembedding                        |               |
| Balanced .....                     | 496           |
| Ground Loop .....                  | 497           |
| Impedance Renormalization .....    | 498           |
| Port Sets .....                    | 494, 495      |
| Single Ended .....                 | 493           |
| Default                            |               |
| Restoring settings .....           | 95            |
| Default Port Assignment .....      | 458           |
| Default values                     |               |
| Remote .....                       | 523           |
| Define Limit Lines dialog .....    | 415           |
| Define Ripple Test dialog .....    | 422           |
| Define Segments dialog .....       | 317           |
| Displayed Columns .....            | 320           |
| Delay .....                        | 230           |
| Delay (Offset Embed) .....         | 500, 501      |
| Delete All Cal Kits .....          | 142           |
| Delete All Mem .....               | 339           |
| Delete Cal Pool .....              | 142           |
| Delete Trace .....                 | 332           |
| Delta Mode .....                   | 431           |
| Denominator .....                  | 385           |
| Destination (memory trace) .....   | 337           |
| Destination (memory traces) .....  | 338           |
| Device ID .....                    | 137           |
| Dflt Marker Frmt .....             | 401           |
| DHCP .....                         | 158, 167      |
| Diagram .....                      | 187, 332, 402 |
| Active Diagram .....               | 402           |
| Add Tr+Diag .....                  | 403           |
| Delete Diagram .....               | 403           |
| Maximize Diagram .....             | 403           |
| Name .....                         | 403           |

- Overlay All ..... 404
- programming examples ..... 961
- Show Title ..... 404
- Title ..... 403
- Trace List ..... 402
- Diagram footer
  - Hiding/restoring ..... 123
- Dialog ..... 207
- Dialog boxes
  - Slider ..... 80
  - Transparency ..... 80
- Dialogs
  - Printing ..... 108
  - Suppressing file selection ..... 113
- Differential mode ..... 227, 228
- Differential Mode ..... 382
- Display
  - Colors ..... 125
  - Diagram ..... 402
  - Settings ..... 120
  - Settings (remote control) ..... 561
  - Theme ..... 125
  - Theme (remote) ..... 565
  - Update (remote) ..... 160
  - Update rate ..... 121
- Display Circle ..... 427
- Display Config ..... 407
  - Channel Info ..... 408
  - Font Size ..... 409
  - Hide Sensitive Information ..... 408
  - Info Table ..... 409
  - Trace Info ..... 409
- Display elements ..... 196
- Display Lines softtool
  - Circle Test tab ..... 424
  - Config tab ..... 407
  - Diagram tab ..... 402
  - Display Circle tab ..... 427
  - Horiz. Line tab ..... 428
  - Limit Test tab ..... 411
  - Ripple Test tab ..... 419
  - Split tab ..... 405
- Display Port
  - Connector ..... 51
- Displayed Columns dialog ..... 320
- Displayed items
  - Touchscreen ..... 122
- Disposal ..... 1010
- Distance Center ..... 300
- Distance Span ..... 300
- Distance Start ..... 300
- Distance Stop ..... 300
- Distance to Fault
  - Sweep points ..... 354
  - Window ..... 353
- Distance to Fault (R&S ZNL-K3) ..... 351
- Distance-to-fault measurements
  - Option R&S ZNL-K3 ..... 288
- DNS server
  - IP Address ..... 169
- Dolph-Chebyshev
  - Side Lobe Level ..... 346
- Driving Mode
  - Alternated ..... 487
  - Auto ..... 487
  - Chopped ..... 487
- Duplicating
  - Channel Setup (remote) ..... 526
- DVI
  - Connector ..... 51
- E**
- Electrical Length ..... 230, 500, 501
- Embedding
  - Balanced ..... 496
  - Differential Match ..... 498, 499
  - Ground Loop ..... 497
  - Impedance Renormalization ..... 498
  - Port Sets ..... 494, 495
  - Single Ended ..... 493
- ENABLE ..... 581, 583
- Enable registers
  - Remote ..... 523
- Entering data ..... 80
- EOI ..... 1017
  - GPIB terminator ..... 160
- Error log ..... 1006
- Error message ..... 1003
- Error queue ..... 581, 594
- Errors ..... 1003
  - Asynchronous ..... 1004
  - During firmware update ..... 1005
  - During measurement ..... 1004
  - FPGA update ..... 1005
  - WRONG\_FW ..... 132
- ESB ..... 586
- ESE ..... 581, 587
- ESR ..... 587
- Evaluation
  - Trying out ..... 68
- Evaluation of data ..... 57
- Evaluation Range Dialog ..... 362
- EVENT register ..... 583
- Event status enable register (ESE)
  - Remote ..... 521
- Event status register (ESR)
  - Remote ..... 522
- Export
  - Sweep segments ..... 320
- Export Data - <File Type> dialog ..... 369
  - Ask Before Overwriting ..... 371
  - Comment Added to File ..... 373
  - Contents ..... 371
  - Output Format ..... 371
- Export Data - ASCII Files dialog
  - Add Ref Impedances ..... 372
  - Decimal Separator ..... 373
  - Field Separator ..... 373
  - Formatted Values ..... 372
- Export Data - MatLab Files dialog
  - Add Ref Impedances ..... 372
  - Field Separator ..... 373
  - Formatted Values ..... 372
- Export Data - Touchstone Files dialog
  - Normalize with Port-Specific Impedances ..... 372
  - Symmetric Params ..... 372
- Export Markers ..... 434
- Export snp Files
  - Active Channel ..... 375
  - All Channels ..... 375
  - Assign port numbers ..... 375
  - Reset Port Assignments ..... 375

|                                     |           |
|-------------------------------------|-----------|
| Select ports .....                  | 375       |
| Select Ports .....                  | 374       |
| Exporting                           |           |
| Functions .....                     | 100       |
| Extended Power Range .....          | 290       |
| External monitor                    |           |
| Connectors .....                    | 51        |
| External reference                  |           |
| Settings (remote control) .....     | 558       |
| <b>F</b>                            |           |
| Factor (averaging) .....            | 308       |
| File type                           |           |
| Storage settings .....              | 102       |
| filename                            |           |
| Data files .....                    | 100       |
| Settings .....                      | 101, 103  |
| Firmware                            |           |
| Updating .....                      | 132       |
| Firmware Update                     |           |
| Remote control .....                | 573       |
| First Partial Meas'ment .....       | 312       |
| Fixture Compensation                |           |
| Auto Length .....                   | 503       |
| Auto Length and Loss .....          | 503       |
| Direct Compensation .....           | 503       |
| Fixture Compensation dialog .....   | 503       |
| Font Size .....                     | 409       |
| Format                              |           |
| Date and time .....                 | 122       |
| Format softtool .....               | 395       |
| FPGA update failure .....           | 1005      |
| Freq for Loss .....                 | 492, 506  |
| Freq Step Size .....                | 310       |
| Frequency                           |           |
| Reference (remote control) .....    | 558       |
| Front panel                         |           |
| Hiding/restoring .....              | 124       |
| Frontend                            |           |
| Temperature (remote) .....          | 561       |
| Function keys                       |           |
| Details - see user manual .....     | 42        |
| Overview .....                      | 42        |
| <b>G</b>                            |           |
| GET .....                           | 155, 1018 |
| Getting started .....               | 18        |
| Global settings .....               | 186       |
| GPIO .....                          | 150       |
| Address .....                       | 159, 172  |
| Characteristics .....               | 154       |
| interface messages .....            | 155       |
| Settings .....                      | 158       |
| Terminator .....                    | 160       |
| GPIO bus control                    |           |
| Remote .....                        | 523       |
| GPIO bus interface .....            | 1016      |
| GPIO interface                      |           |
| Configuring - see user manual ..... | 48        |
| Connector .....                     | 48        |
| GPIO Interface .....                | 292       |
| Graphical zoom .....                | 83        |
| Group Delay .....                   | 399       |
| Aperture Points .....               | 400       |
| GTL .....                           | 155, 1018 |

|                                        |                 |
|----------------------------------------|-----------------|
| <b>H</b>                               |                 |
| Handshake bus .....                    | 1016            |
| Hardcopy                               |                 |
| see Screenshots .....                  | 62              |
| Hardware                               |                 |
| Check .....                            | 132             |
| Information .....                      | 129             |
| Supported .....                        | 132             |
| Hardware (connectors) .....            | 1014            |
| Harmonic grid .....                    | 284             |
| Automatic .....                        | 348             |
| Set and keep .....                     | 347             |
| Headphones                             |                 |
| Connector .....                        | 50              |
| Help .....                             | 84              |
| Hide All Data .....                    | 339             |
| Hide All Mem .....                     | 339             |
| Hide All Other Traces .....            | 332             |
| Hide Sensitive Information .....       | 408             |
| Hiding/restoring                       |                 |
| Display items .....                    | 122             |
| HiSLIP .....                           | 150             |
| Protocol .....                         | 151             |
| Resource string .....                  | 150             |
| Horiz. Line .....                      | 428             |
| Response Value .....                   | 429             |
| Show Horiz. Line .....                 | 429             |
| <b>I</b>                               |                 |
| I/O Logging .....                      | 160             |
| I/Q Analyzer                           |                 |
| Application .....                      | 87              |
| Trying out .....                       | 63              |
| Ideal (cal kit) .....                  | 256             |
| Identification                         |                 |
| Remote .....                           | 522             |
| String, R&S ZNL/ZNLE .....             | 159             |
| String, resetting (R&S ZNL/ZNLE) ..... | 159             |
| IEC/IEEE bus                           |                 |
| see GPIB .....                         | 150             |
| IEC/IEEE Bus Interface .....           | 1016            |
| IECWIN .....                           | 580             |
| IEEE 488 CH 1 .....                    | 1016            |
| IEEE 488 CH 2 .....                    | 1016            |
| IF/VIDEO/DEMODO .....                  | 49              |
| Connector .....                        | 155, 1017, 1018 |
| IFC .....                              | 399             |
| Imag .....                             | 399             |
| Image Suppr.                           |                 |
| Auto .....                             | 487             |
| LO < RF .....                          | 487             |
| LO > RF .....                          | 487             |
| Impedance .....                        | 221             |
| Import                                 |                 |
| Cal Kit .....                          | 464             |
| Sweep segments .....                   | 320             |
| Import Complex Data dialog .....       | 368             |
| Import Data to New Mem .....           | 369             |
| Import Data to New Mem .....           | 369             |
| Importing                              |                 |
| Functions .....                        | 100             |
| Impulse Response .....                 | 346             |
| Info Table .....                       | 409             |

- Information
  - Hardware ..... 129
  - Options ..... 130
  - Version ..... 130
- Installing
  - Options ..... 131
- Instrument calibration ..... 55
- Instrument Messages ..... 1019
- Instrument name
  - Changing ..... 169
- Instrument security procedures ..... 19
- Interface
  - functions (GPIB bus) ..... 1018
- Interface Clear ..... 1017
- Interface messages
  - GPIB ..... 1018
- Interfaces ..... 1014
  - GPIB ..... 154
  - LAN ..... 150
- Inv Smith ..... 399
- Inverted Smith chart ..... 215
- IP address ..... 150
  - Assigning ..... 167
  - Network ..... 158
- IP Address
  - DNS server ..... 169
- IP configuration
  - LAN ..... 171
- IST flag ..... 581, 587
  - Remote ..... 522
- Items
  - Saving ..... 99
  - Settings ..... 102
- K**
- K 21 (softkey) ..... 394
- Key
  - DOWN ..... 44
  - LEFT ..... 45
  - Power ..... 41
  - RIGHT ..... 45
  - UP ..... 44
- Keyboard
  - On-screen ..... 79
- Keypad
  - Overview ..... 43
- Keys
  - PRESET ..... 95
- Kit Standards dialog ..... 472
  - Add standard ..... 473
  - Copy... standard ..... 473
  - Delete standard ..... 473
  - One Port Standards ..... 473
  - Read .s1p File... ..... 474
  - Read .s2p File... ..... 474
  - Two Port Standards ..... 473
  - View / Modify... standard ..... 473
- L**
- LAN
  - Configuration ..... 163
  - Configuring ..... 170
  - Connector ..... 51
  - Interface ..... 150
  - IP address ..... 150
  - LAN configuration ..... 171
  - Password ..... 163
  - Ping ..... 172
  - Remote control interface ..... 149
  - Reset ..... 163
  - Settings ..... 162
  - VISA ..... 150
  - VXI protocol ..... 151
  - Web browser interface ..... 170
- LFEOI
  - GPIB terminator ..... 160
- Limit line ..... 231
  - files ..... 237
- Limit Test ..... 411, 415
  - Add / Insert / Delete segment ..... 417
  - Clear Test ..... 414
  - Delete All segments ..... 417
  - Limit Check ..... 412
  - Limit Fail Beep ..... 413
  - Limit line from trace data ..... 417
  - Recall limit line ..... 417
  - Save limit line ..... 417
  - Segments ..... 416
  - Shift Lines ..... 415
  - Show Limit Line ..... 412
- Limit Test tab
  - Controls ..... 412
- Limits
  - Global Check ..... 414
  - TTL1 Pass ..... 414
  - TTL2 Pass ..... 414
- Lin Freq ..... 312
- Lin Mag ..... 398
- LLO ..... 155, 1018
- Loading
  - Functions ..... 100
  - Instrument settings ..... 104
  - Settings ..... 96, 97
  - Trying out ..... 61
- Log Freq ..... 313
- Log Mag ..... 398
- Logical Port
  - Offset Embed Differential Match ..... 518
- Login
  - Network ..... 173
- Logo
  - Printing ..... 108
- Loss
  - Active ..... 491
  - Loss (bandfilter) ..... 204
  - Loss at DC ..... 492, 506
  - Loss at Freq ..... 492, 506
  - Loss parameters
    - definition ..... 266
  - Low pass impulse ..... 283
  - Low Pass Settings dialog ..... 347
  - Low pass step ..... 283
  - Lower edge (bandfilter) ..... 204
  - Lower limit ..... 231
- M**
- Maintenance ..... 1010, 1019
- Marker ..... 199
  - Delta Mode ..... 431
  - Discrete ..... 433
  - Format ..... 433



|                                              |          |
|----------------------------------------------|----------|
| Info .....                                   | 434      |
| Mkr 1 ... Mkr 10 .....                       | 431      |
| Mode .....                                   | 433      |
| Name .....                                   | 432      |
| On .....                                     | 430      |
| Properties .....                             | 432      |
| Props .....                                  | 432      |
| Ref Mkr -> Mkr .....                         | 434      |
| Response .....                               | 430      |
| Settings .....                               | 429      |
| Stimulus .....                               | 430      |
| Style .....                                  | 433      |
| Marker coupling .....                        | 203      |
| Marker Format .....                          | 433      |
| Marker Info .....                            | 434      |
| Marker info field .....                      | 200      |
| Marker Mode                                  |          |
| Arbitrary .....                              | 433      |
| Fixed .....                                  | 433      |
| Normal .....                                 | 433      |
| Marker Name .....                            | 432      |
| Marker Search                                |          |
| Max / Min .....                              | 439      |
| Next Peak .....                              | 439      |
| Peak Left / Peak Right .....                 | 439      |
| Peak Type .....                              | 439, 440 |
| Search Mode .....                            | 447      |
| Marker search functions .....                | 204      |
| Marker Search softtool                       |          |
| Bandfilter tab .....                         | 447      |
| Multiple Peak tab .....                      | 443      |
| Target Search tab .....                      | 445      |
| Marker Settings softtool                     |          |
| Info Field tab .....                         | 436      |
| Marker Coupling tab .....                    | 436      |
| Marker Props tab .....                       | 432      |
| Markers tab .....                            | 429      |
| Set by Marker tab .....                      | 434      |
| Marker softtool                              |          |
| Peak tab .....                               | 438      |
| Marker Style .....                           | 433      |
| Markers                                      |          |
| All Off .....                                | 431      |
| Coupled Markers .....                        | 432, 437 |
| Export .....                                 | 434      |
| Ref Mkr .....                                | 431      |
| Trying out .....                             | 70       |
| Max (softkey, trace scale) .....             | 303      |
| Max = Marker .....                           | 435      |
| Meas                                         |          |
| S-Params .....                               | 376      |
| Meas Delay .....                             | 311      |
| Meas softtool .....                          | 375      |
| Ratios tab .....                             | 383      |
| S-Params tab .....                           | 376      |
| Stability tab .....                          | 394      |
| Wave tab .....                               | 386      |
| Y-Z-Params tab .....                         | 392      |
| Y←Sij tab .....                              | 390      |
| Z←Sij tab .....                              | 388      |
| Measure Fixture .....                        | 504      |
| Measurement examples .....                   | 52       |
| Measurement results .....                    | 217      |
| Measurement zoom .....                       | 83       |
| Measurements .....                           | 375      |
| Converted admittances .....                  | 390      |
| Converted impedances .....                   | 388      |
| Port activation on demand .....              | 376      |
| Ratios of wave quantities .....              | 383      |
| S-parameters .....                           | 376      |
| Stability factors K, $\mu_1$ , $\mu_2$ ..... | 394      |
| Wave quantities .....                        | 386      |
| Y-parameters .....                           | 392      |
| Z-parameters .....                           | 392      |
| Mechanical Length .....                      | 500, 501 |
| Mem Math tab                                 |          |
| Controls .....                               | 339      |
| Menus                                        |          |
| Context-sensitive .....                      | 78       |
| Min (softkey, trace scale) .....             | 303      |
| Min = Marker .....                           | 435      |
| Mini front panel                             |          |
| Hiding/restoring .....                       | 124      |
| Key combination .....                        | 125      |
| Using .....                                  | 128      |
| Mixed mode parameters .....                  | 228      |
| Mode conversion factor .....                 | 228      |
| Mode tab                                     |          |
| Driving Mode .....                           | 487      |
| Image Suppr. .....                           | 487      |
| Monitor                                      |          |
| External .....                               | 127      |
| Settings .....                               | 127      |
| More Ratios dialog .....                     | 384      |
| More Wave Quantities dialog .....            | 387      |
| Multiple Peak search .....                   | 443      |
| Eval Range .....                             | 444      |
| Max .....                                    | 444      |
| Min .....                                    | 444      |
| Tracking .....                               | 444      |
| Multiple triggers                            |          |
| Source .....                                 | 326      |
| MultiView                                    |          |
| Tab .....                                    | 87, 90   |
| Trying out .....                             | 65       |
| <b>N</b>                                     |          |
| Navigation                                   |          |
| Controls .....                               | 44       |
| in tables .....                              | 44       |
| Navigation keys .....                        | 44       |
| NDAC .....                                   | 1017     |
| Network                                      |          |
| Auto-login .....                             | 174      |
| Changing user passwords .....                | 174      |
| Configuration (dialog box) .....             | 158      |
| Configuring .....                            | 166      |
| Connecting the instrument .....              | 167      |
| Creating users .....                         | 173      |
| DNS server .....                             | 169      |
| Login .....                                  | 173      |
| Operating the instrument .....               | 172      |
| Setting up .....                             | 166      |
| Settings .....                               | 157      |
| Settings (remote) .....                      | 567      |
| Sharing directories .....                    | 175      |
| Noise Figure                                 |          |
| Application .....                            | 87       |
| Noise source control                         |          |
| Connector .....                              | 49       |
| Notch (time gate) .....                      | 350      |
| NRFD .....                                   | 1017     |
| NTR .....                                    | 581      |

- NTRansition ..... 583, 585
- Number of Points ..... 297, 310
- Numerator ..... 385
- Numeric parameters ..... 80
- Numeric Suffix (remote control) ..... 596
- O**
- OCXO ..... 120
- OCXO frequency reference ..... 292
- Offset
  - Active ..... 491
- Offset Embed
  - All Offsets Off ..... 492
  - All Offsets On ..... 492
  - Balanced ..... 496
  - Differential Match Embedding ..... 498
  - Fixture Compensation ..... 503
  - Ground Loop ..... 497
  - Impedance Renormalization ..... 498
  - Loss ..... 491
  - Loss active ..... 491
  - Offset active ..... 491
  - Port Pairs ..... 510
  - Port Sets ..... 494
  - Reset Offsets ..... 491
  - Reset Offsets (and losses) ..... 492
  - Single Ended deembedding ..... 493
  - Single Ended embedding ..... 493
- Offset Embed dock widget ..... 490
  - Balanced panel ..... 496
  - Calculation Flow ..... 490
  - Differential Match panel ..... 498
  - Ground Loop panel ..... 497
  - Impedance Renormalization panel ..... 498
  - Offset ..... 491
  - Overview ..... 490
  - Port Sets panel ..... 494
  - Single Ended panel ..... 493
- Offset Embed softtool ..... 490
  - Balanced tab ..... 512
  - Differential Match tab ..... 517
  - Ground Loop tab ..... 515
  - Offset tab ..... 499
  - One Way Loss tab ..... 505
  - Port Sets tab ..... 510
  - Single Ended tab ..... 507
- Offset parameters ..... 265
  - application ..... 270
  - balanced ports ..... 271
  - definition ..... 266
- Offset tab
  - Fixture Compensation dialog ..... 503
- On-screen keyboard ..... 79, 81
- Online help
  - Working with ..... 84
- Operating mode
  - Presetting ..... 135
- Operation complete ..... 587
  - Remote ..... 522
- OPERation register ..... 581, 588
- Optimizing
  - Calibration signal display ..... 67
- Option
  - R&S FPL1-B4 ..... 292
  - R&S FPL1-B10 ..... 292
  - R&S ZNL-B19 ..... 290
  - R&S ZNL-K2 ..... 344, 349
  - R&S ZNL-K3 (Distance to Fault) ..... 351
  - R&S ZNL3|4|6|14|20-B3x ..... 291
  - R&S ZNL3|4|6|14|20-B22 ..... 290
  - R&S ZNLE-B19 ..... 290
- Option R&S ZNL-K2
  - Time domain analysis ..... 282
- Option R&S ZNL-K3
  - Distance-to-fault measurements ..... 288
- Options
  - Identification (remote) ..... 522
  - Information ..... 130
  - Installing ..... 130, 131
- Options (overview) ..... 281
- Orientation
  - Screenshot ..... 114
- P**
- Packing ..... 1020
- Parallel Poll ..... 593
- Parallel poll register enable
  - Remote ..... 523
- Parameter (remote control) ..... 596
- Parameters
  - Entering ..... 80, 81
  - Passing between applications ..... 89
- Partial measurement ..... 190
- Passwords
  - Changing ..... 174
  - Service functions ..... 141
- Peak ..... 438
- Peak list
  - Trying out ..... 71
- Permittivity ..... 501
- Persistent settings ..... 186
- Phase ..... 396
- Ping ..... 172
- Polar ..... 397
- Polar diagram ..... 212
- Port
  - Gender ..... 463
  - Offset ..... 500
- Ports
  - Calibration ..... 455, 462
- Power ..... 298
  - Key ..... 41
- Power (system settings) ..... 146
- Power sensors
  - Configuring - see user manual ..... 51
  - Connector ..... 51
  - Using - see user manual ..... 51
- Power supply
  - Connector ..... 47
- Power tab ..... 297, 306
- PPC ..... 155, 1018
- PPE ..... 581, 587
- PPU ..... 155, 1018
- Precision Oven Quartz Frequency Reference ..... 292
- Preset ..... 594
  - channel setup settings ..... 96
  - Key ..... 95
  - Recalling settings ..... 105
- Print Screen
  - Softkey ..... 111
- Printer
  - Selecting ..... 113

- Printers
    - Installing ..... 114
  - Printing
    - Colors ..... 125, 126
    - Colors (remote) ..... 565
    - Medium ..... 112
    - Screenshots ..... 111, 116
    - Trying out ..... 62
  - Program example ..... 982
    - calibration ..... 982
  - Programming examples ..... 957
    - Sequencer ..... 531
    - Statistics ..... 557
  - Protocol
    - VXI ..... 151
  - PTR ..... 584
  - PTRansition ..... 583
- Q**
- Quality factor (bandfilter) ..... 204
  - QUESTionable register ..... 581, 588
    - Summary bit ..... 586
  - QUESTionable:INTegrity register ..... 589
  - QUESTionable:LIMit register ..... 588
  - Quick recall
    - Settings ..... 97
  - Quick save
    - Settings ..... 97
- R**
- R&S FPL1-B4 ..... 292
  - R&S FPL1-B10 ..... 292
  - R&S FSV
    - Emulating ..... 161
  - R&S Support ..... 137
  - R&S ZNL-B19 ..... 290
  - R&S ZNL-K2 ..... 344, 349
  - R&S ZNL-K3 (Distance to Fault) ..... 351
  - R&S ZNL3|4|6|14|20-B3x ..... 291
  - R&S ZNL3|4|6|14|20-B22 ..... 290
  - R&S ZNLE-B19 ..... 290
  - R&S ZVR compatible commands ..... 935
  - Ratio ..... 226
  - Ratios tab ..... 383
  - Real ..... 398
  - Rear panel
    - Aux. Port ..... 1014
    - Overview ..... 46
  - Rebooting
    - Remote control ..... 525
  - Recall Ripple Test ..... 424
  - Recall set ..... 187
  - Recalling
    - Settings ..... 96, 97, 100, 103
    - Settings for preset ..... 105
    - Softkey ..... 100
  - Receiver Step Attenuators ..... 291
  - Ref Mkr -> Mkr ..... 434
  - Ref Pos ..... 303
  - Ref Val = Marker ..... 435
  - Ref Value ..... 303
  - Ref. In
    - Connector ..... 48
  - Ref. Out
    - Connector ..... 48
  - Reference
    - Frequency (remote control) ..... 558
  - Reference impedance ..... 219
  - Reflection measurement (example) ..... 58
  - Release notes ..... 19, 21
  - Remote control ..... 966
    - basic concepts ..... 576
    - Interfaces ..... 149
    - LAN settings ..... 162
    - Protocols ..... 149
  - Remote Desktop ..... 166, 178
    - Client ..... 180
    - Ending session ..... 182
    - Setting up a connection ..... 182
    - Setting up controller ..... 180
    - Setting up instrument ..... 179
  - Remote display
    - Update ..... 160
  - Remote operation
    - Deactivating the instrument ..... 184
    - GPIB address ..... 172
    - GPIB settings ..... 158
    - Setting up ..... 166
    - Settings ..... 156
    - Starting ..... 184
    - Stopping ..... 185
  - REN ..... 1017
  - Renormalization (of port impedances) ..... 219
  - Renormalization theory
    - Power waves ..... 383
    - Travelling waves ..... 383
  - Reset values
    - Remote ..... 523
    - Status reporting system ..... 594
  - Resolution Enh(ancement) ..... 346
  - Restart Manager dialog ..... 329
    - Sweep Active Channel ..... 330
    - Sweep All Channels ..... 330
  - Restart Sweep ..... 328
  - Restart Sweep on Std. Meas. .... 466
  - Results
    - Managing ..... 95
    - Storing (remote) ..... 554
  - Revision ..... 21
  - Revision string
    - GPIB (remote control) ..... 570
  - RF Input
    - Connector ..... 45
  - RF Off All Channels ..... 298
  - Ripple limit ..... 231
    - files ..... 238
  - Ripple Test ..... 419, 422
    - Clear Test ..... 422
    - Ranges ..... 423
    - Ripple Check ..... 421
    - Ripple Fail Beep ..... 421
    - Show Results All Traces ..... 422
    - Show Ripple Limits ..... 420
  - Rotary knob ..... 44
- S**
- S-parameter ..... 218
  - S-parameter buttons ..... 377
  - S-Parameter selector ..... 376
  - S-Parameter Wizard ..... 53, 378
  - S-Params tab ..... 376

- Safety instructions ..... 19
- Save Ripple Test ..... 424
- Save/Recall Mode
  - Settings ..... 102
- Savesets
  - Settings ..... 98
- Saving
  - Data types ..... 99
  - Functions ..... 100
  - Instrument settings ..... 104
  - Screenshots ..... 116
  - Settings ..... 100
  - Softkey ..... 100
  - Trying out ..... 60, 62
- Scale
  - Scale Coupling ..... 303
- Scale Coupling tab ..... 303
- Scale softtool ..... 300
  - Scale Coupling tab ..... 303
  - Scale Values tab ..... 301
  - Zoom tab ..... 304
- Scale Values tab ..... 301
- Scale/Div ..... 302
- SCPI
  - version ..... 156
- SCPI status register ..... 583
  - event status register ..... 587
  - IST flag ..... 587
  - parallel poll enable register ..... 587
  - service request enable register ..... 586
  - status byte ..... 586
  - STATus:OPERation register ..... 588
  - STATus:QUESTionable register ..... 588
  - STATus:QUESTionable:INTEGRity ..... 589
  - STATus:QUESTionable:LIMit ..... 588
  - Structure ..... 581
- Screen elements ..... 196
- Screenshots
  - Printing ..... 111, 116
  - Saving ..... 111, 116
  - Trying out ..... 62
- SDC ..... 155, 1018
- Search functions ..... 204
- Search Path for additional Cal Kits and Connector Types
  - ..... 143
- Search Range dialog ..... 440
  - Range Limit Lines On ..... 442
  - Search Range ..... 441
  - Select Marker ..... 441
- Search settings
  - Trying out ..... 71
- Security procedures ..... 19
- Seg X-Axis ..... 316
- Segmented sweep ..... 314
  - Define Segments dialog ..... 317
  - Export segments ..... 320
  - Import segments ..... 320
- Select Parameter dialog ..... 373
- Select Ports dialog ..... 374
- Selectivity ..... 307
- Self-test
  - Performing ..... 138
  - Remote ..... 524
  - Results ..... 138, 560
  - Settings ..... 138
- Selftest
  - Remote ..... 574
- Sequencer
  - Aborted ..... 138
  - Activating (remote) ..... 530
  - Channel Setups ..... 90
  - Example ..... 92
  - Mode ..... 91, 93
  - Programming example ..... 531
  - Remote control ..... 526
  - Run Single ..... 93
  - Setting up ..... 93
  - Single Sweep ..... 93
  - Softkey ..... 93
  - State ..... 93
  - Trying out ..... 72
- Sequences
  - Aborting (remote) ..... 529
  - Mode (remote) ..... 530
- Serial poll ..... 593
- Service functions ..... 136, 140
  - Passwords ..... 141
  - Results ..... 141
- Service manual ..... 18
- Service request ..... 591
- Service Request Enable ..... 581, 586
- Service request enable register (SRE)
  - Remote ..... 524
- Set by Marker ..... 434
  - Center ..... 435
  - Max ..... 435
  - Min ..... 435
  - Ref Value ..... 435
  - Span ..... 435
  - Start ..... 435
  - Stop ..... 435
  - Zero Delay at Marker ..... 436
- Settings
  - filename ..... 101, 103
  - Loading ..... 104
  - Managing ..... 95
  - Recalling ..... 96, 97
  - Recalling; restrictions ..... 97
  - Saving ..... 99, 104
  - Storage location ..... 101, 103
  - Storing ..... 96, 97
- Shape (time gate) ..... 350
- Shift trace
  - response ..... 366
  - stimulus ..... 365
- Shift Trace ..... 365
- Show <Trace Name> ..... 332
- Show All Data ..... 339
- Show All Mem ..... 339
- Show All Traces ..... 332
- Show as ..... 388
- Show Cal Kit Label ..... 142
- Show Point List ..... 319
- Show/Hide data trace ..... 337
- Show/Hide memory trace ..... 337
- Shutdown
  - Remote control ..... 526
- Side lobe level
  - Frequency window ..... 346
- Side Lobe Level (time gate) ..... 351
- Single Sequencer
  - Softkey ..... 93
- Single sweep ..... 327

- Single sweep mode
  - Sweeps (# of) ..... 328
- Single-ended mode ..... 227, 228
- Sliding Match ..... 257
- SmartGrid
  - Trying out ..... 68
- Smith ..... 396
- Smith chart ..... 213
- Smoothing ..... 364
  - Aperture ..... 364
- Soft front panels
  - Using ..... 128
- Softkey bar
  - Hiding/restoring ..... 123
- Softkeys
  - Comment ..... 108
  - Continuous Sequencer ..... 93
  - Install Printer ..... 114
  - Print Screen ..... 111
  - R&S Support ..... 137
  - Recall ..... 100
  - Recall File ..... 99, 102
  - Save ..... 100
  - Save File ..... 102
  - Sequencer ..... 93
  - Single Sequencer ..... 93
  - Startup Recall ..... 102
  - Startup Recall (On/Off) ..... 103
- Softtools ..... 77
- Source
  - Calibration ..... 462
- Source Port ..... 385
- SPAN ..... 191
- Span = Marker ..... 435
- Span Frequency ..... 296
- SPD ..... 155, 1018
- SPE ..... 155, 1018
- Spectrograms
  - Trying out ..... 68
- Spectrum
  - Application ..... 86
- Split All ..... 405
- Split diagrams ..... 405
  - Dual Split ..... 406
  - Quad Split ..... 406
  - Triple Split ..... 406
- Split Type ..... 406
- SRE ..... 581, 586
- SRQ ..... 581, 591, 1017
- Stability (softkey) ..... 394
- Stability factors ..... 230
- Stability tab ..... 394
- START ..... 191
- Start = Marker ..... 435
- Start Frequency ..... 296
- Startup recall
  - Remote ..... 540
- Startup Recall
  - Softkey ..... 103
- Statistics
  - Programming example ..... 557
- Status bar
  - Hiding/restoring ..... 123
- Status byte
  - Remote ..... 521, 524
- Status registers ..... 581
  - STATUs:QUEStionable:TEMPerature ..... 561
- Status reporting system
  - Common commands ..... 521
  - Error queue ..... 594
  - Parallel poll ..... 593
  - Queries ..... 593
  - Reset values ..... 594
  - Serial poll ..... 593
  - Service request ..... 591
- STB ..... 581, 586
- Step attenuators ..... 298
- Stimulus softtool ..... 295
  - Power tab ..... 297
  - Stimulus tab ..... 296
  - Time Domain X-Axis tab ..... 299
- Stimulus tab ..... 296
  - Center Frequency ..... 296
  - CW Frequency ..... 297
  - Number of Points ..... 297
  - Power ..... 298
  - Span Frequency ..... 296
  - Start Frequency ..... 296
  - Stop Frequency ..... 296
- STOP ..... 191
- Stop = Marker ..... 435
- Stop Frequency ..... 296
- Storage ..... 1010
- Storage location
  - Data files ..... 100
  - Settings ..... 101, 103
- Storage settings
  - File type ..... 102
- Storing ..... 1020
  - Settings ..... 96, 97
- Subnet Mask ..... 158
- Support ..... 1006
  - Information ..... 136, 137
  - Information (remote) ..... 574
- Suppressing
  - File name dialog ..... 113
- Sweep
  - Sweep Params ..... 309
- Sweep Active Channel ..... 330
- Sweep All Channels ..... 330
- Sweep Control
  - Restart Manager dialog ..... 329
- Sweep Control tab ..... 327
- Sweep History ..... 980
- Sweep mode
  - Continuous ..... 327
  - Single ..... 327
- Sweep range selection ..... 54
- Sweep settings ..... 309
- Sweep softtool
  - Sweep Control tab ..... 327
  - Sweep Type tab ..... 312
  - Trigger tab ..... 322
- Sweep Time ..... 311
- Sweep Type
  - CW Mode ..... 314
  - Lin Freq ..... 312
  - Log Freq ..... 313
  - Segmented ..... 314
  - Time ..... 315
- Sweep Type tab ..... 312
- Sweeps (# of) ..... 328
- SWR ..... 397
- Symmetric Params ..... 372

- System
  - Configuration ..... 129
  - Configuration (remote) ..... 570
  - Keys ..... 41
  - Messages ..... 132
  - Preset operating mode ..... 135
- T**
- Tabs**
  - Channel Setups ..... 85
  - MultiView ..... 87
- Target Search ..... 445, 447
  - Search Left ..... 447
  - Target Format ..... 446
  - Target Value ..... 446
- Technical support ..... 1006
- Temperature
  - Check (remote) ..... 561
  - Frontend (remote) ..... 561
  - Self-alignment (remote) ..... 561
- Theme
  - Display ..... 125, 126
  - Display (remote) ..... 565
- Time**
  - Format ..... 122
  - Hiding/restoring ..... 123
  - Instrument setting ..... 121
- Time Center ..... 299
- Time Domain ..... 345
- Time domain analysis ..... 344, 349
  - Option R&S ZNL-K2 ..... 282
- Time Domain Transform ..... 282
- Time domain transformation
  - Impulse Response ..... 346
  - Type ..... 346
- Time Domain X-Axis tab ..... 299
- Time Gate ..... 350
  - Bandpass ..... 350
  - Notch ..... 350
  - Shape ..... 350
  - Show Range Lines ..... 350
  - Side Lobe Level ..... 351
- Time Span ..... 299
- Time Start ..... 299
- Time Stop ..... 299
- Time sweep ..... 315
- Time vs. Distance ..... 300
- Title (diagram) ..... 197
- Toolbar**
  - Hiding/restoring ..... 123
- Touchscreen**
  - Colors ..... 125
  - De-/Activating ..... 121
  - Displayed items ..... 122
  - Overview ..... 39
  - Settings ..... 120
  - Theme ..... 126
- Touchstone (\*.s<n>p) file ..... 239
- Trace ..... 187, 197
  - Dfit Marker Frmt ..... 401
  - Hold ..... 365
  - Max Hold ..... 365
  - Min Hold ..... 365
  - programming examples ..... 961
  - Shift Trace ..... 365
  - Smoothing ..... 364
- Trace Data
  - Export ..... 367
  - Import ..... 367
  - Import Complex Data ..... 368
- Trace Data import
  - Auto Distribute traces ..... 374
  - Deselect All traces ..... 374
  - Select All traces ..... 374
  - Select Parameter ..... 373
- Trace files ..... 238
- Trace format ..... 395
  - dB Mag ..... 395
  - Delay ..... 399
  - Imag ..... 399
  - Inv Smith ..... 399
  - Lin Mag ..... 398
  - Log Mag ..... 398
  - Phase ..... 396
  - Polar ..... 397
  - Real ..... 398
  - Smith ..... 396
  - SWR ..... 397
  - Unwr Phase ..... 397
- Trace formats ..... 209
- Trace Info ..... 409
- Trace list ..... 198
- Trace Manager dialog ..... 333
  - Add ..... 334
  - Couple All Channels ..... 334
  - Couple All Scales ..... 335
  - Decouple All Channels ..... 334
  - Decouple All Scales ..... 335
  - Delete ..... 334
- Trace Math ..... 340
  - Data - <Mem> ..... 340
  - Data / <Mem> ..... 340
  - User Defined ..... 341
- Trace softtool ..... 330
  - All Mem All Data tab ..... 337
  - Distance to Fault tab ..... 351
  - Hold ..... 363
  - Mem tab ..... 335
  - Shift Trace ..... 363
  - Smooth Shift Hold tab ..... 363
  - Smoothing ..... 363
  - Time Domain tab ..... 344
  - Time Gate tab ..... 349
  - Trace Data tab ..... 367
  - Trace Statistics tab ..... 359
  - Traces tab ..... 330
- Trace Statistics ..... 359
  - Evaluation Range ..... 362, 363
  - Evaluation Range Limit Lines On ..... 363
  - Flatness/Gain/Slope ..... 362
  - Format ..... 361
  - Mean/Std Dev/RMS ..... 360
  - Min/Max/Peak-Peak ..... 360
  - Phase/EI Length ..... 361
- Tracking
  - marker search, target search ..... 440
- Transmission measurement (example) ..... 53
- Trigger**
  - Delay ..... 325
  - Event (remote) ..... 524
  - External ..... 323
  - FreeRun ..... 323
  - Manual ..... 323

|                                               |          |
|-----------------------------------------------|----------|
| Manual Trigger .....                          | 324      |
| Multiple Triggers .....                       | 323      |
| Sequence .....                                | 324      |
| Signal Type .....                             | 325      |
| Source .....                                  | 323      |
| Trigger In                                    |          |
| Connector .....                               | 49       |
| Trigger Manager dialog .....                  | 325      |
| Source .....                                  | 326      |
| Trigger tab .....                             | 322      |
| Controls .....                                | 323      |
| Troubleshooting .....                         | 1003     |
| File name error .....                         | 540      |
| Remote control programs .....                 | 160      |
| Trying out                                    |          |
| Prerequisites .....                           | 52       |
| Typical (cal kit) .....                       | 256      |
| <b>U</b>                                      |          |
| Unbalance-balance conversion .....            | 227      |
| Universal command .....                       | 1018     |
| Unwr Phase .....                              | 397      |
| Update Path                                   |          |
| Remote control .....                          | 573      |
| Update rate                                   |          |
| Display .....                                 | 121      |
| Updating                                      |          |
| Firmware .....                                | 132      |
| Upper edge (bandfilter) .....                 | 204      |
| Upper limit .....                             | 231      |
| Upper/lower case (remote control) .....       | 595      |
| USB                                           |          |
| Connector .....                               | 51       |
| Connectors .....                              | 41       |
| Use Cal tab                                   |          |
| Recall Last Cal Set .....                     | 480      |
| User Cal Active .....                         | 480      |
| User Def Math dialog .....                    | 341      |
| Expression builder .....                      | 342      |
| Result is Wave Quantity .....                 | 343      |
| User Interface (system settings) .....        | 143      |
| Conductance in Embedding Networks .....       | 144      |
| Decimal Places .....                          | 144      |
| Reset Decimal Places .....                    | 145      |
| Reset Dialogs .....                           | 145      |
| Reset Units Prefix .....                      | 145      |
| Show Sweep Symbols .....                      | 144      |
| Sounds .....                                  | 143      |
| Transparent Info Fields .....                 | 144      |
| Units Prefix .....                            | 145      |
| Use Default Tab for Hardkey .....             | 144      |
| Users                                         |          |
| Network .....                                 | 173      |
| Password .....                                | 174      |
| <b>V</b>                                      |          |
| Velocity Factor .....                         | 501      |
| Version information .....                     | 130      |
| View / Modify Cal Kit Standards dialog .....  | 474      |
| Char. Impedance .....                         | 474      |
| Characteristic impedance Z <sub>0</sub> ..... | 474      |
| Delay .....                                   | 474      |
| Electrical Length .....                       | 474      |
| Load parameters .....                         | 475      |
| Loss .....                                    | 474      |
| Offset Loss .....                             | 474      |
| Offset parameters .....                       | 474      |
| Virtual differential mode .....               | 227      |
| VISA .....                                    | 150      |
| Libraries .....                               | 156      |
| Resource string .....                         | 150, 156 |
| VNA                                           |          |
| Application .....                             | 86       |
| VNA Port Assignment .....                     | 478      |
| VNA Setup dialog                              |          |
| Advanced tab .....                            | 145      |
| Calibration tab .....                         | 141      |
| Power tab .....                               | 146      |
| User Interface tab .....                      | 143      |
| VXI protocol .....                            | 151      |
| <b>W</b>                                      |          |
| Wait                                          |          |
| Remote .....                                  | 524      |
| Wave quantities                               |          |
| Source port .....                             | 388      |
| Wave quantity .....                           | 226, 388 |
| Wave tab .....                                | 386      |
| Web browser                                   |          |
| Configuration interface .....                 | 170      |
| White papers .....                            | 20       |
| Windows                                       |          |
| Access .....                                  | 34       |
| Dialog boxes .....                            | 80       |
| Wizard .....                                  | 53       |
| WRONG_FW                                      |          |
| Error .....                                   | 132      |
| <b>Y</b>                                      |          |
| Y <- (softkey) .....                          | 391      |
| Y <- S-Parameters                             |          |
| Model .....                                   | 391      |
| Y-parameter .....                             | 224      |
| Y-parameters .....                            | 392      |
| Y-Z-Params tab .....                          | 392      |
| Y/Z-Parameter (softkey) .....                 | 392      |
| Y←S <sub>ij</sub> tab .....                   | 390      |
| Y<-S <sub>11</sub> (softkey) .....            | 391      |
| Y<-S <sub>12</sub> (softkey) .....            | 391      |
| Y<-S <sub>21</sub> (softkey) .....            | 391      |
| Y<-S <sub>22</sub> (softkey) .....            | 391      |
| Y11 (softkey) .....                           | 393      |
| Y12 (softkey) .....                           | 393      |
| Y21 (softkey) .....                           | 393      |
| Y22 (softkey) .....                           | 393      |
| <b>Z</b>                                      |          |
| Z ← (softkey) .....                           | 389      |
| Z <- S-Parameters                             |          |
| Model .....                                   | 390      |
| Z-parameter .....                             | 223      |
| Z-parameters .....                            | 392      |
| Z←S <sub>11</sub> (softkey) .....             | 389      |
| Z←S <sub>12</sub> (softkey) .....             | 389      |
| Z←S <sub>21</sub> (softkey) .....             | 389      |
| Z←S <sub>22</sub> (softkey) .....             | 389      |
| Z←S <sub>ij</sub> tab .....                   | 388      |
| Z11 (softkey) .....                           | 393      |
| Z12 (softkey) .....                           | 393      |

|                            |     |
|----------------------------|-----|
| Z21 (softkey) .....        | 393 |
| Z22 (softkey) .....        | 393 |
| Zero Delay at Marker ..... | 436 |
| Zoom                       |     |
| Graphical .....            | 83  |
| Max .....                  | 306 |
| Measurement .....          | 83  |
| Min .....                  | 306 |
| Overview On .....          | 306 |
| Start .....                | 306 |
| Stop .....                 | 306 |
| Zoom Reset .....           | 306 |
| Zoom Select .....          | 305 |
| Zoom tab .....             | 304 |
| Zooming                    |     |
| Trying out .....           | 59  |