

# AC/DC High Accuracy Current Probe

**CTB20B (20A/1MHz)**

**CTB200B (200A/500kHz)**

**CTB500B (500A/100kHz)**

**CTB1000B (1000A/20kHz)**



Shenzhen Zhiyong Electronics Co., Ltd.

## Preface

First of all, thank you for purchasing our products, this instruction manual is the description about the function, usage, operation attention points, etc. Before use, please read the instructions carefully and use correctly.

Manual annotation will use the following symbols to distinguish.



**This symbol means it is harmful to the machine and human body; you must strictly follow the instruction manual to operate.**



**In the case of wrong operation, the user risk injury. The content under this mark records the relevant matters needing attention to avoid such dangers.**

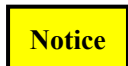

**The user may suffer minor injuries and material damage with the wrong operation. To avoid such situation, the matters under this mark need attention.**

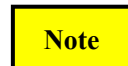

**This symbolizes important note about how to use the machine.**

To the safely use the machine, you must abide by the following safety precautions strictly. The violation against the manual is likely to damage the protective function of the machine. In addition, the company is not responsible for any safety problem caused by the violation of matters needing attention in operation.



- ◆ Please avoid direct contact with the naked conductor, or there will be shortage or shock accident.
- ◆ Please measure on the insulated wire that has proper insulation from the circuit voltage.
- ◆ Shock accident will possibly occur if the device or the user's hand is wet, please watch out.
- ◆ The maximum measurable current will change according to the frequency. As the treatment to lower the rated value, maximum continuous measurable current will be limited. Please do not measure the current with lower amplitude surpassing rated value. The malfunction caused by sensor heating will possibly cause fire accident and burn.

**Warn**

- ◆ Do not use the top part of the clamp to fix the foreign matter. This could possibly lower the performance of the sensor characteristics or malfunction the switch.
- ◆ Do not input current to the device when the power supply is cut off, or the device will possibly be damaged.
- ◆ Please do not step on or clamp on the wire to protect its skin.
- ◆ Do not touch the core part when the clamp is opened. Static electricity on the core could possibly damage the device.
- ◆ Please remain the clamp close in spare time. The dust on the clamp contact surface could case the measurement error.
- ◆ Please undo the lock before pulling out the input connector, or the connector will be damage by force.
- ◆ The cable will be hardened in the environment below 0°C. The cable skin or even cable itself will be damaged if cable is forced to bow or pulled.
- ◆ Please avoid vibration or impact when the device is in operation or transportation, especially the falling impact.
- ◆ Please avoid the operation under sunny, thermal, damp and humid environment. Deformation and worsen insulation will ruin the operation specification.
- ◆ Please check the device before usage to make sure the device is not malfunctioned caused by storage and transportation. Please contact the commission agent or operator nearby when malfunction is observed.
- ◆ The device is not designed neither waterproof nor dust-proof. Do not use the device under dusty and complex chemical environment.
- ◆ Do not use the device in the strong EM wave environment or close to the electrified object.
- ◆ Do not use the device near any sort of induction heating device. (e.g. Induction cooker)

## Index

Preface.....	1
Summary.....	4
Application.....	4
Product Description.....	4
Option Device.....	5
Product Electronic Specification.....	5
Machinery Specification.....	9
Environment Characteristics.....	9
Operating Methods.....	9
Note During Operation.....	9
Measurement Steps.....	10
Packing List.....	11

## 1. Summary

CTB series current probe is a kind of current probe which can measure DC and AC at the same time. It is a clamp type current sensor which can be opened / closed for AC / DC current measure. Its characteristics include: high precision, typical value 0.3%; good frequency and temperature characteristics; high bandwidth. CTBxxxA need to cooperate with CTB104 (Four channel sensor unit) in operation, while CTBxxxB series is powered by 12V adaptor. With the power analyzer, it can realize power analyze in the high accuracy current measurement.

## 2. Application

- Power supply (Switch type and linear type) design
- Neo energy, electric vehicle design
- Variable frequency household appliance
- Electric industrial experiment
- Inverter/transformer design
- Electronic Ballast
- Industrial/consumer electronics design
- Engine drive design
- Power electronics and electrical drive experiment
- Traffic transport system (Electric mobile, locomotive, avionic device) design

## 3. Product Description

Take CTB500B/1000B as example:

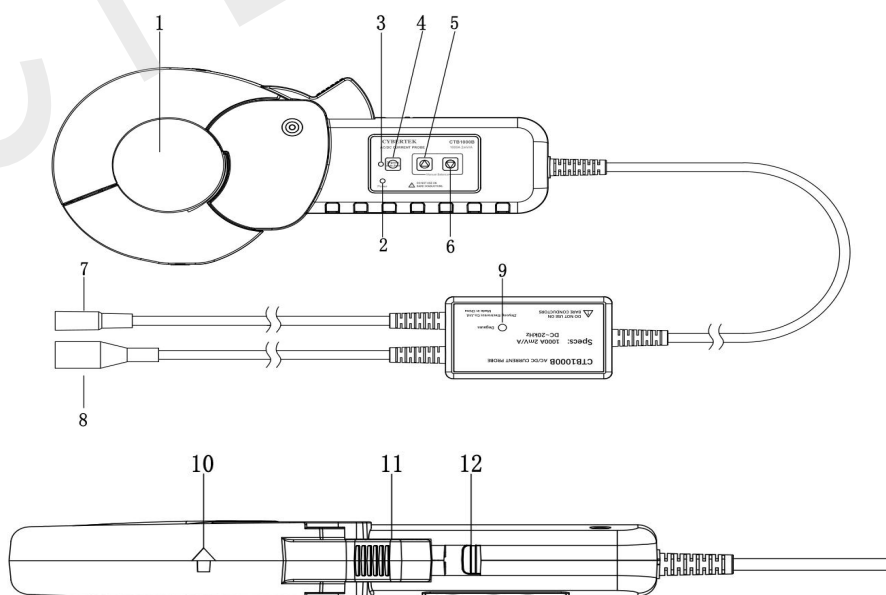

- ① **Jaw:**CTB20B/CTB200B diameter 20mm,CTB500B/CTB1000B diameter 50mm.
- ② **Power indicator:** lighted green indicates power on.
- ③ **Degaussing indicator:** lighted red when degaussing button was pressed. After the degaussing, indicator will be off.
- ④ **Handle auto degaussing button:** After frequent usages, the residual field on the probe will influence the accuracy of the device. Press the button to degauss before the next measurement to improve the performance.
- ⑤ **Offset adjust button(increase):** press to increase offset. Pressing over 2s will continuously increase the output offset.
- ⑥ **Offset adjust button(decrease):** press to decrease offset. Pressing over 2s will continuously decrease the output offset.
- ⑦ **Power supply wire:** Power supply wire connecting with 12V adaptor.
- ⑧ **Output wire:** Signal output port connecting test equipment.
- ⑨ **Distribution box auto degaussing button:** perform same function as handle degaussing button, Press the button to degauss before the next measurement to improve the performance.
- ⑩ **Current direction mark:** Current direction should be the same as the mark, or the output will be negative.
- ⑪ **Open/Close handle:** Control the jaw through this handle
- ⑫ **Lock push rod:** Control the lock and unlock of the jaw.

#### 4. Accessories

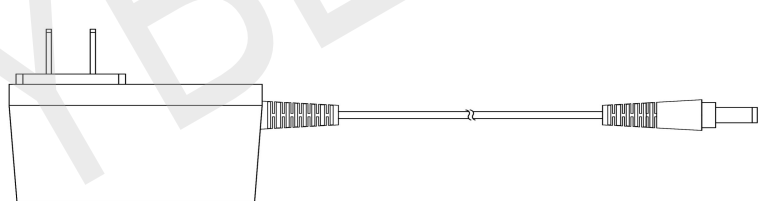

Power supply adaptor (CK-612)

#### 5. Product Electronic Specification

- f.s. Maximum display value or scale length (symbolizing the rated primary current range)
- rdg. Reading value (symbolizing the current value under measurement, or the current value indicated by the measurement devices)
- Proceed measurement under condition of sin wave input, central conductor position and powered by 12V adaptor.
- Measuring device of input resistance over  $1M\Omega$
- Please correctly degauss zero set before the measurement.

	<b>CTB20B</b>	<b>CTB200B</b>	<b>CTB500B</b>	<b>CTB1000B</b>
Rated current	AC/DC 20A	AC/DC 200A	AC/DC 500A	AC/DC 1000A
Bandwidth	1MHz	500kHz	100kHz	20kHz
Current transfer ratio	100mV/A	10mV/A	4mV/A	2mV/A
Maximum input current	Refer to the Current rated value vs. Frequency curve			
Accuracy	Refer to the Accuracy List			
Operating temperature and humidity range	-40°C~85°C, Below 80%RH (No dew)			
Promised accuracy range	0°C~40°C, Below 80%RH			
Temperature drift coefficient	-40°C~0°C、40°C~85°C Amplitude Sensitivity: Below±0.02% rdg./°C Offset Voltage:≤±0.01% f.s./°C			
Diameter of measurable conductor	Φ Below 20 mm		Φ Below 50 mm	
Conductor position effect	Below ±0.1% rdg. (Input 20A, DC-100Hz, outer diameter 5mm)	Below ±0.1% rdg. (Input 100A, DC-100Hz, outer diameter 5mm)	Below ±0.2% rdg. (Input 100A, DC-100Hz, outer diameter 10mm)	Below ±0.2% rdg. (Input 1000A, 50Hz/60Hz, outer diameter 30mm)
Power supply method	DC 12V/1A (standard adaptor)			

### CTB20B Accuracy List

Frequency	Amplitude	Phase
DC	±0.3% rdg. ±0.05% f.s.	-
DC < f ≤ 100 Hz	±0.3% rdg. ±0.01% f.s.	±0.1deg.
100Hz < f ≤ 500 Hz	±0.3% rdg. ±0.02% f.s.	±0.2deg.
500Hz < f ≤ 1kHz	±0.5% rdg. ±0.02% f.s.	±0.5deg.
1kHz < f ≤ 5kHz	±1.0% rdg. ±0.02% f.s.	±1.0deg.
5kHz < f ≤ 10kHz	±1.5% rdg. ±0.02% f.s.	±1.5deg.
10kHz < f ≤ 50kHz	±2.0% rdg. ±0.02% f.s.	±(0.5+0.1×f kHz)deg.
50kHz < f ≤ 100kHz	±5.0% rdg. ±0.05% f.s.	
100kHz < f ≤ 300kHz	±10% rdg. ±0.05% f.s.	
300kHz < f ≤ 500kHz	±15% rdg. ±0.05% f.s.	-
500kHz < f ≤ 1MHz	±30% rdg. ±0.05% f.s.	-

**CTB200B Accuracy List**

Frequency	Amplitude	Phase
DC	±0.3% rdg. ±0.02% f.s.	-
DC < f ≤ 100 Hz	±0.3% rdg. ±0.01% f.s.	±0.1deg.
100Hz < f ≤ 500 Hz	±0.3% rdg. ±0.02% f.s.	±0.2deg.
500Hz < f ≤ 1kHz	±0.5% rdg. ±0.02% f.s.	±0.5deg.
1kHz < f ≤ 5kHz	±1.0% rdg. ±0.02% f.s.	±1.0deg.
5kHz < f ≤ 10kHz	±1.5% rdg. ±0.02% f.s.	±1.5deg.
10kHz < f ≤ 50kHz	±5.0% rdg. ±0.02% f.s.	±(0.5+0.1×f kHz)deg.
50kHz < f ≤ 100kHz	±15% rdg. ±0.05% f.s.	
100kHz < f ≤ 300kHz	±15% rdg. ±0.05% f.s.	
300kHz < f ≤ 500kHz	±30% rdg. ±0.05% f.s.	-

**CTB500B Accuracy List**

Frequency	Amplitude	Phase
DC	±0.3% rdg. ±0.02% f.s.	-
DC < f ≤ 100 Hz	±0.3% rdg. ±0.01% f.s.	±0.1deg.
100Hz < f ≤ 500 Hz	±0.3% rdg. ±0.02% f.s.	±0.2deg.
500Hz < f ≤ 1kHz	±0.5% rdg. ±0.02% f.s.	±0.5deg.
1kHz < f ≤ 5kHz	±1% rdg. ±0.02% f.s.	±1.5deg.
5kHz < f ≤ 10kHz	±1.5% rdg. ±0.02% f.s.	±2.0deg.
10kHz < f ≤ 20kHz	±5% rdg. ±0.02% f.s.	±(0.2×f kHz)deg.
20kHz < f ≤ 50kHz	±10% rdg. ±0.05% f.s.	
50kHz < f ≤ 100kHz	±30% rdg. ±0.05% f.s.	

**CTB1000B Accuracy List**

Frequency	Amplitude	Phase
DC	±0.3% rdg. ±0.02% f.s.	-
DC < f ≤ 100 Hz	±0.3% rdg. ±0.01% f.s.	±0.1deg.
100Hz < f ≤ 500 Hz	±0.5% rdg. ±0.02% f.s.	±0.2deg.
500Hz < f ≤ 1kHz	±1% rdg. ±0.02% f.s.	±0.5deg.
1kHz < f ≤ 5kHz	±2% rdg. ±0.02% f.s.	±1.5deg.
5kHz < f ≤ 10kHz	±5% rdg. ±0.05% f.s.	±2.0deg.
10kHz < f ≤ 20kHz	±30% rdg. ±0.1% f.s.	±10.0deg.



**CTB20B**

Current rated value vs. Frequency curve

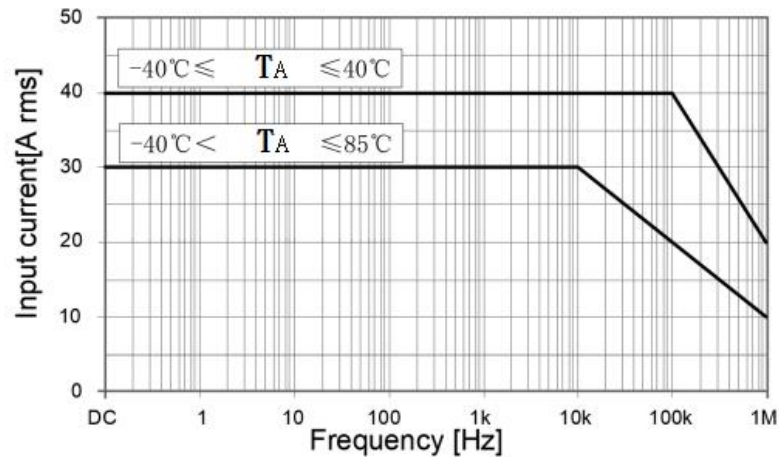

$T_A$ : ambient temperature

**CTB200B**

Current rated value vs. Frequency curve

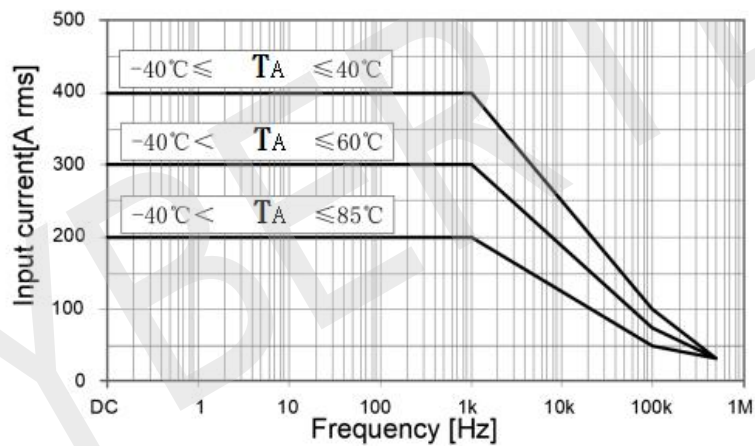

$T_A$ : ambient temperature

**CTB500B**

Current rated value vs. Frequency curve

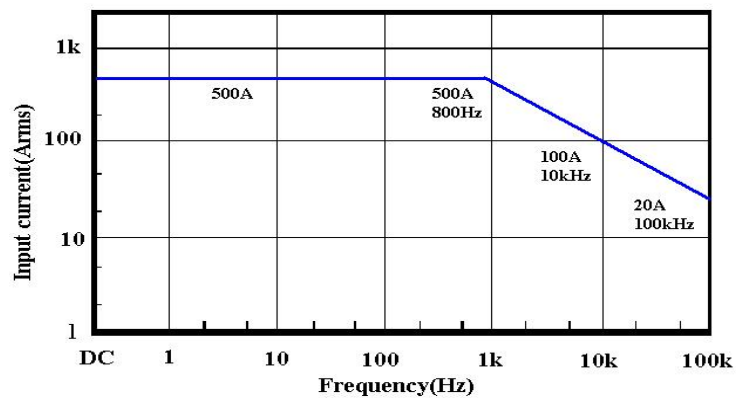

## CTB1000B

### Current rated value vs. Frequency curve

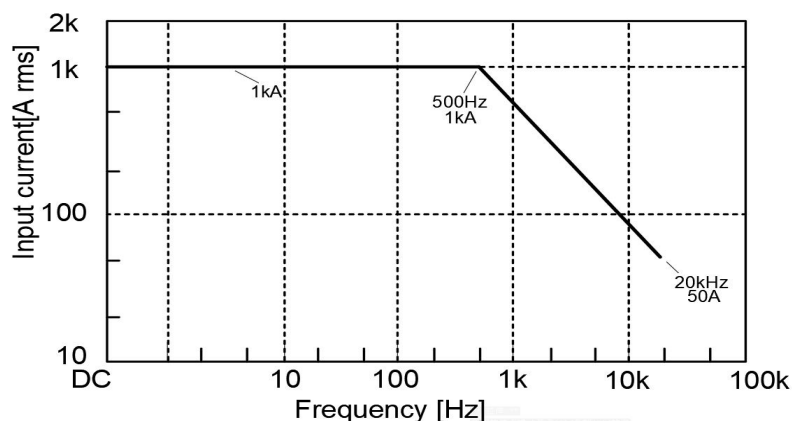

## 6. Machinery Specification

	CTB20B	CTB200B	CTB500B	CTB1000B
Jaw diameter	20mm		50mm	
Connecting cable length	3m			
Current clamp handle dimension (L*W*H)	162*80*31mm		246*116*35mm	
Probe weight	385g		750g	880g

## 7. Environment Characteristics

Operation environment	Indoor, pollution level 2
Operation temperature and humidity	-40°C~85°C, below 80% RH(no dew)
Storage temperature and humidity	-40°C~85°C, below 80% RH(no dew)
Operation altitude	2000m
Storage altitude	12000m

## 8. Operation Methods

### Note During Operation

**Note**

- ✧ The device is powered by 12V adaptor in measurement. Please select the high input resistance (1MΩ) when output to the oscilloscope. If the input resistance is 50Ω, the measurement will be error.
- ✧ Make sure the current under test is below the maximum value. The magnetic core will be saturated if rated value is surpassed. As the result the waveform generated will be partially cut off and the surge current will cause failure on core degaussing process, need to be adjust again to zero set.
- ✧ If there's high magnetic field (e.g. transformer, large circuit) or strong current (e.g. wireless) near the

probe, measurement may not proceed normally

- ✧ The frequency of the current under test will generate resonance. This will not influence the result.
- ✧ The position of the conductor under test within the sensor head will influence the result. Please adjust the conductor to the central position of the sensor head.
- ✧ Push the lock control rod till “unlock” symbol disappear during the testing.
- ✧ If the high potential side of the circuit is inserted in the high frequency field, the result will possibly be influenced by the noise. Please limit the frequency band of the waveform observer when necessary or inset the low potential side.
- ✧ Do not try to degauss zero set or adjust offset during current input states.
- ✧ The offset output of the probe will be influence by the environment (geomagnetism, magnetic field generator) and temperature. Please proceed the degaussing under actual environment.
- ✧ The offset can be caused by the impact on probe.
- ✧ Please close the jaw before degauss the probe.
- ✧ To improve the sensitivity of the system, twine the conductor on jaw when measuring the DC or current below 1kHz. 10 turns will output signal of 10 times strong.
- ✧ The high potential side of the clamping circuit in high frequency range can be influenced by the public mode noise. Please clamp on the low potential side according to your need.
- ✧ Since the probe applies flux gate theory, harmonic noise of around 1.6MHz is expected during output.
- ✧ When measuring high frequency large current about 1kHz, the position of the conductor will cause the increase of error and distortion of waveform. Please set the conductor in the central position. For those conductors not under test with high frequency large current about 500A or 1kHz, please set them away from the jaw, or the measurement error and waveform distortion is likely to occur.



**Warn**

- ☞ Please unlock and pull out the connector before remove the output port. Output terminal will be damage if locked wire is pulled by force
- ☞ **Continuous maximum input range is the fixed value defined by the device heat. Do not apply the current over the range or the device will be damaged.**
- ☞ **The continuous maximum input range will change according to the frequency of current under test. The probe will be burned if current surpassing maximum is continuously applied.**
- ☞ The heating of the sensor under continuous current surpassing maximum input range will cause improper output. Please cut off the input current and wait for the full cool down before the next attempt.

### Measurement Steps

- ✧ Connect the current probe to 12V adaptor.
- ✧ Connect the BNC output port to the terminal such as oscilloscope and power analyzer through BNC wire.

- ❖ Confirm sensor power supply function normal and the probe is powered up.
- ❖ Executing degaussing. Proceed by the button on probe or distribution box.
- ❖ Unlock the jaw through lock push rod.
- ❖ Open the jaw using on/off handle
- ❖ Clamp on the wire under test according to the current direction (Or the signal output will be reversed) and close the jaw.
- ❖ Close the jaw using lock push rod.
- ❖ Start measurement
- ❖ Remove the device from the conductor after measurement is over.
- ❖ Cut off the probe's power supply
- ❖ Remove the probe from sensor unit.

## 9. Packing List

Packing List	
Name	Amount
Current Probe	1
DC12V Adaptor (CK-612)	1
Instruction Manual	1
Warranty Card	1
Test Report	1

## TESTLINK

### TESTLINK Corporation

**Addr:** (14348) B 709 (XI Tower) , 67 Saebitgongwon-ro, Gwangmyeong-si, Gyeonggi-do, Korea

**Tel:** +82.2.6299.7588

1588-8679

**Fax:** +82.2.6299.7581

**Email:** [sales@testlink.co.kr](mailto:sales@testlink.co.kr)

**URL:** <http://www.testlink.co.kr>

© Zhiyong Electronics, 2023

Published in China, May 1, 2023