

# PicoScope<sup>®</sup> 5000D Series

FlexRes<sup>®</sup> oscilloscopes and MSOs

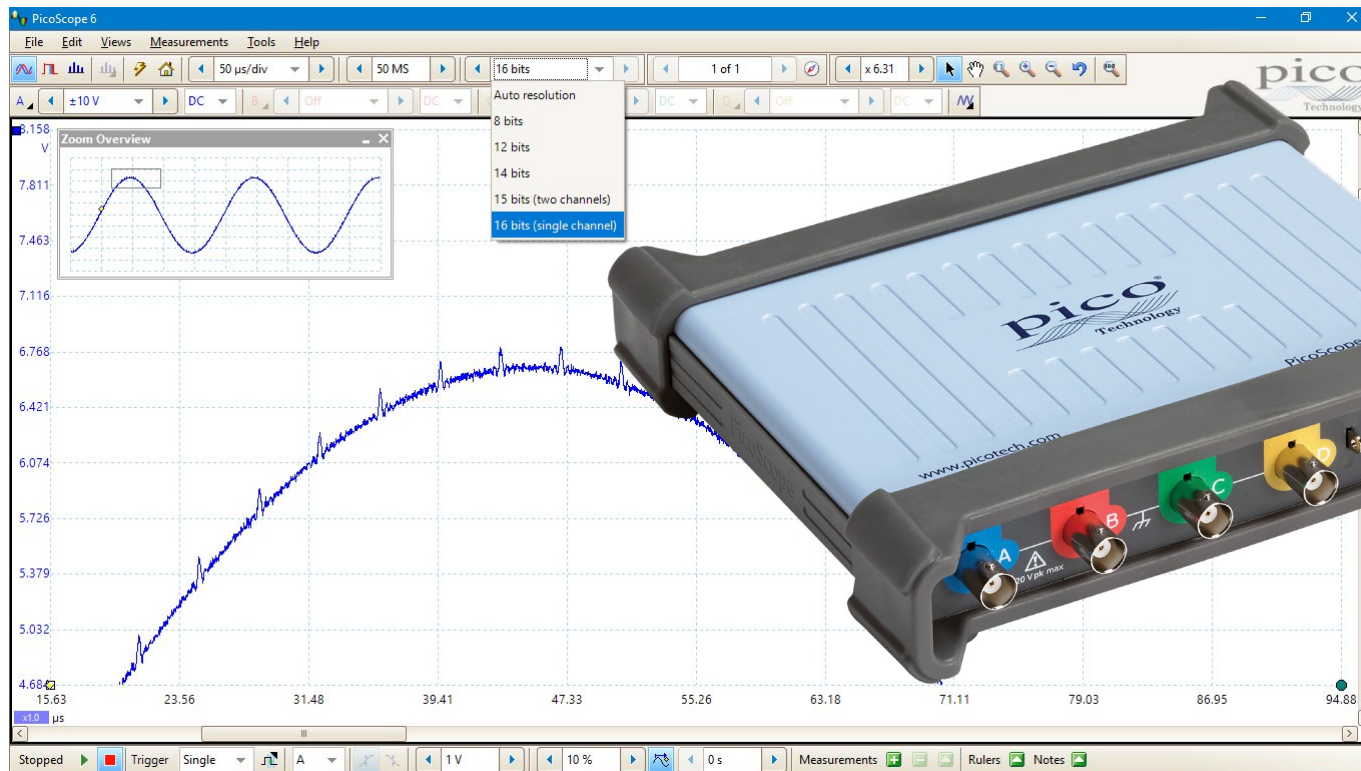

## The complete all-rounders

FlexRes flexible 8 to 16-bit hardware resolution

Up to 200 MHz analog bandwidth

1 GS/s sampling at 8-bit resolution

500 MS/s sampling at 12-bit resolution

62.5 MS/s sampling at 16-bit resolution

Up to 512 MS capture memory

16 digital channels (on MSO models)

130 000 waveforms per second

Built-in arbitrary waveform generator

Serial decoding as standard (20 protocols)

Up to 200 MHz spectrum analyzer

PicoScope, PicoLog<sup>®</sup> and PicoSDK<sup>®</sup> software included

Silent, fanless design

## Introduction

Today's electronic designs employ a wide range of signal types: analog, digital, serial (both high- and low-speed), parallel, audio, video, power distribution and so on. All need to be debugged, measured and validated to ensure that the device under test is functioning correctly and within specification.

To handle this variety of signal types, PicoScope 5000D Series FlexRes oscilloscopes provide 8 to 16 bits of vertical resolution, with up to 200 MHz bandwidth and 1 GS/s sampling speed. You select the most appropriate hardware resolution for the requirements of each measurement.

PicoScopes include advanced features such as mask limit testing, serial decoding, advanced triggering, automatic measurements, math channels (including the ability to plot frequency and duty cycle against time), XY mode and segmented

memory. The PicoScope 5000D Series also benefits from Pico's award-winning DeepMeasure™ feature and FlexRes flexible resolution.

Other key features of the PicoScope 5000D Series include:

- Deep capture memory – from 128 million to 512 million samples
- 2 or 4 analog channels
- Mixed-signal models add 16 digital channels
- Serial decoding – analyze 20 protocols (more in development)
- USB 3.0 connection for continuous high-speed data streaming
- Small, light and portable

Supported by the free and regularly updated PicoScope 6 software, these devices offer an ideal, cost-effective package for many applications, including design, research, test, education, service and repair.

## What is FlexRes?

Pico FlexRes flexible resolution oscilloscopes allow you to reconfigure the scope hardware to increase either the sampling rate or the resolution.

This means you can reconfigure the hardware to be either a fast (1 GS/s) 8-bit oscilloscope for looking at digital signals or a high-resolution 16-bit oscilloscope for audio work and other analog applications.

Whether you're capturing and decoding fast digital signals or looking for distortion in sensitive analog signals, FlexRes oscilloscopes are the answer.

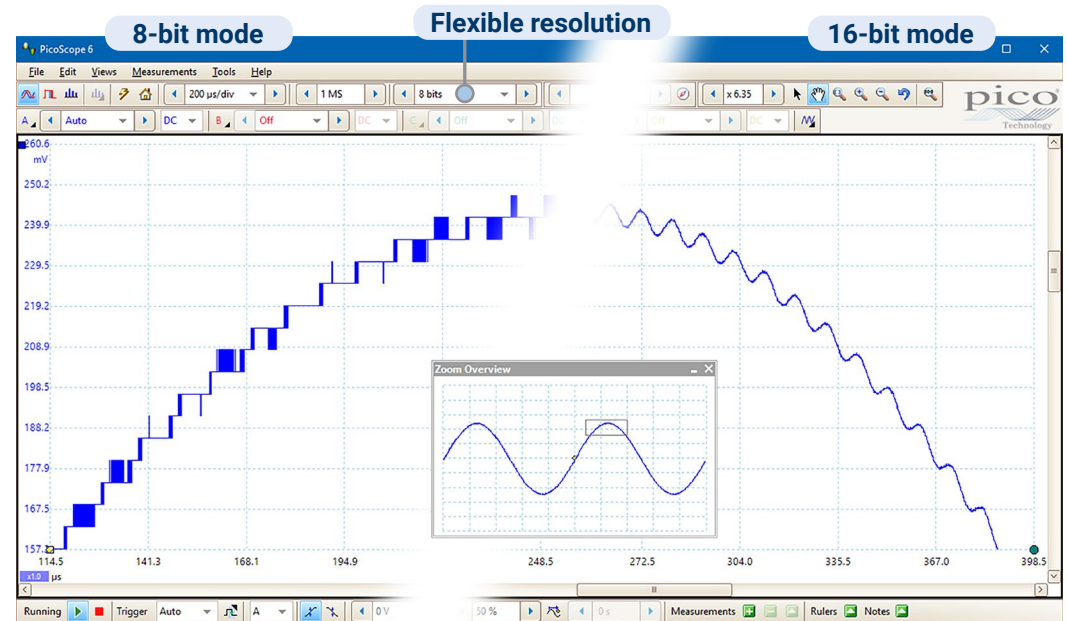

## Advanced display

PicoScope 6 software dedicates the majority of the display area to the waveform, ensuring that the maximum amount of data is visible at all times. The size of the display is only limited by the size of your computer's monitor, so even with a laptop, the viewing area is much bigger, with much higher resolution, than that of a benchtop scope.

With such a large display area available, you can create a customizable split-screen display and view multiple channels or different views of the same signal at the same time – the software can even show multiple oscilloscope and spectrum analyzer views at once.

Each view has separate zoom, pan and filter settings for ultimate flexibility.

You can control the PicoScope 6 software using a mouse, touchscreen or customizable keyboard shortcuts.

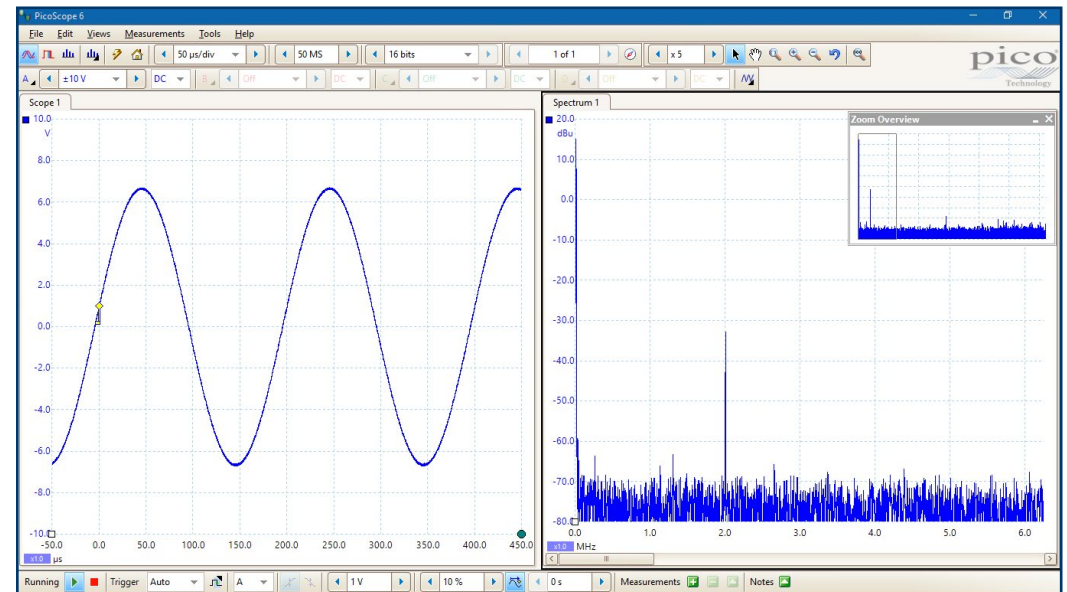

## Low-level signals

With its 16-bit resolution, the PicoScope 5000D Series can magnify low-level signals at high zoom factors. This allows you to view and measure features such as noise and ripple superimposed on larger DC or low-frequency voltages.

Additionally, you can use the Lowpass Filtering controls on each channel independently, to hide noise and reveal the underlying signal.

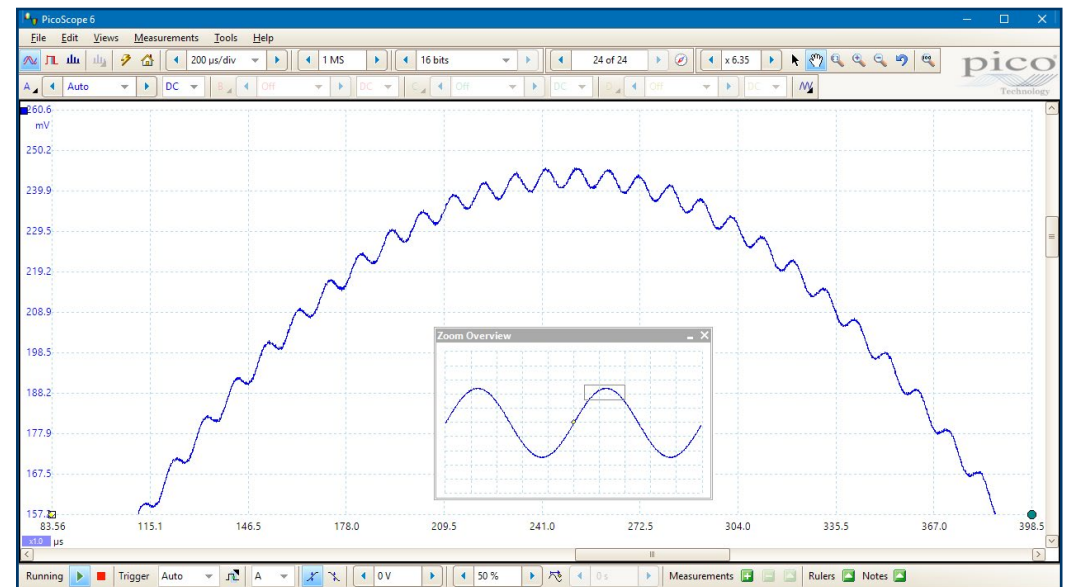

## High bandwidth, high sampling rate

Many USB-powered oscilloscopes have real-time sampling rates of only 100 or 200 MS/s, but the PicoScope 5000D Series offers up to 1 GS/s, and a maximum bandwidth of 200 MHz.

## Deep capture memory

PicoScope 5000D Series oscilloscopes have waveform capture memories ranging from 128 megasamples to 512 megasamples – many times larger than competing scopes. Deep memory enables the capture of long-duration waveforms at maximum sampling speed. In fact, the PicoScope 5000D Series can capture waveforms over 500 ms long with 1 ns resolution. In contrast, the same 500 ms waveform captured by an oscilloscope with a 10 megasample memory would have just 50 ns resolution.

Deep memory can be useful in other ways too: PicoScope 6 lets you divide the capture memory into a number of segments, up to a maximum of 10 000. You can set up a trigger condition to store a separate capture in each segment, with as little as 1  $\mu$ s dead time between captures. Once you have acquired the data, you can step through the memory one segment at a time until you find the event you are looking for.

Powerful tools are included to allow you to manage and examine all of this data. As well as functions such as mask limit testing and color persistence mode, the PicoScope 6 software enables you to zoom into your waveform by a factor of several million. The Zoom Overview window allows you to easily control the size and location of the zoom area. Other

Equivalent time sampling (ETS) mode can be used to further boost the effective sampling rate to 10 GS/s for a more detailed view of repetitive signals.

tools, such as the waveform buffer, serial decoding and hardware acceleration work with the deep memory, making the PicoScope 5000D some of the most powerful oscilloscopes on the market.

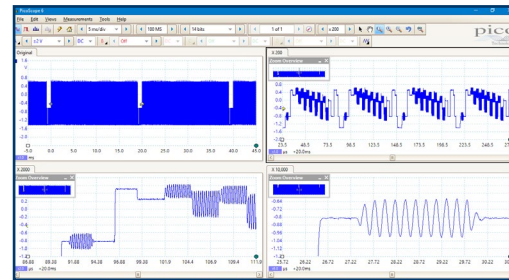

## DeepMeasure

The PicoScope 6 DeepMeasure tool uses deep memory to analyze every cycle contained in each triggered waveform acquisition. It displays the results in a table, with the parameter fields shown in columns and waveform cycles shown in rows: you can easily sort the results by any parameter and correlate them with the waveform display, or export them as a CSV file or spreadsheet for further analysis.

DeepMeasure calculates sixteen parameters per cycle, including cycle time, frequency, pulse width, duty cycle, rise and fall time, overshoot, undershoot, max voltage and min voltage. Parameters include Start and end times relative to the trigger are given for each cycle. The tool can display up to a million cycles.

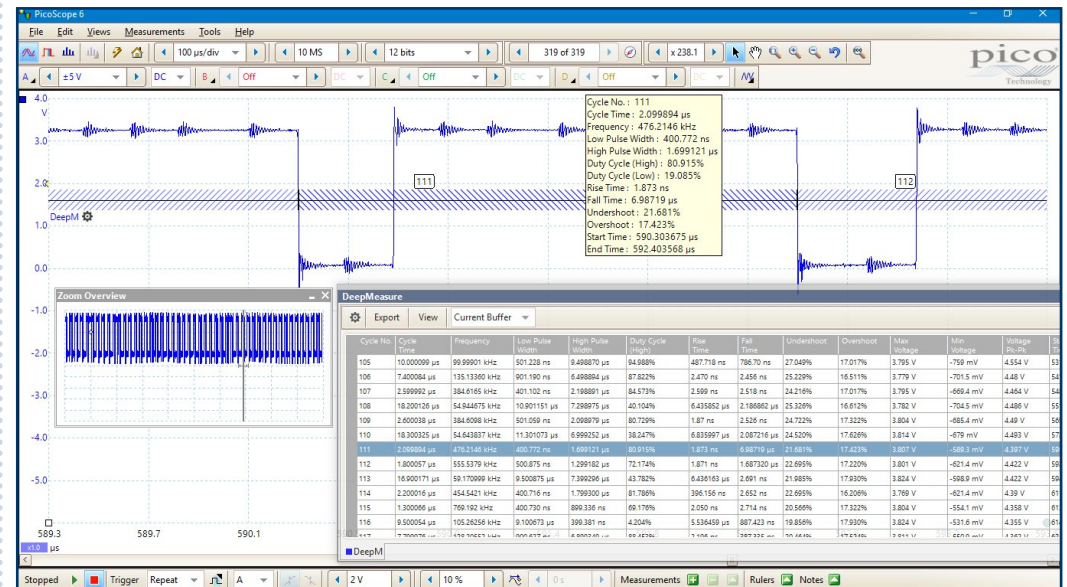

## Waveform buffer and navigator

Ever spotted a glitch on a waveform, but by the time you've stopped the scope it's gone? With PicoScope you no longer need to worry about missing glitches or other transient events, as it can store the last 10 000 waveforms in its circular waveform buffer.

The buffer navigator provides an efficient way of navigating and searching through waveforms, effectively letting you turn back time. When carrying out a mask limit test, you can also set the navigator to show only mask fails, enabling you to find any glitches quickly.

## Mixed-signal models

The PicoScope 5000D MSO models add 16 digital channels to the 2 or 4 analog channels, enabling you to accurately time-correlate analog and digital channels. Digital channels may be grouped and displayed as a bus, with each bus value displayed in hex, binary or decimal or as a level (for DAC testing). You can set advanced triggers across both the analog and digital channels.

The digital inputs also bring extra power to the serial decoding options. You can decode serial data on all analog and digital channels simultaneously, giving you up

## Persistence mode

PicoScope 6 persistence mode options allow you to see old and new data superimposed, with newer waveforms drawn in a brighter color or deeper shade. This makes it easy to spot glitches and dropouts and estimate their relative frequency – useful for displaying and interpreting complex analog signals such as video waveforms and analog modulation signals.

The PicoScope 5000D Series' HAL3 hardware acceleration means that, in Fast Persistence mode, waveform update rates of up to 130 000 waveforms per second are achievable.

to 20 channels of data – for example decoding multiple SPI, I<sup>2</sup>C, CAN bus, LIN bus and FlexRay signals all at the same time.

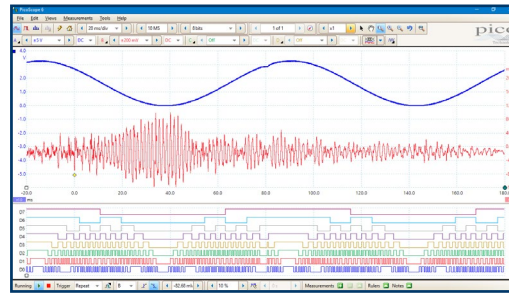

Color-coding or intensity-grading shows which areas are stable and which are intermittent. Choose between analog intensity, digital color and fast display modes or create your own custom setup.

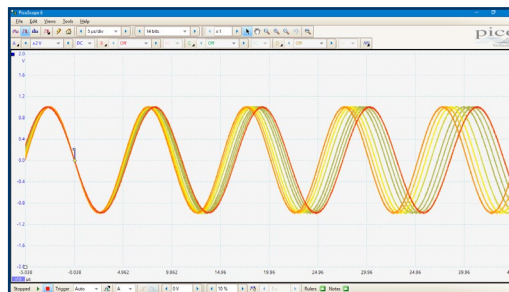

## Arbitrary waveform and function generator

All PicoScope 5000D units have a built-in 14-bit 200 MS/s arbitrary waveform generator (AWG). You can create and adapt arbitrary waveforms using the built-in editor, import them from existing oscilloscope traces, or load a waveform from a spreadsheet.

The AWG can also act as a function generator with a range of standard output signals, including sine, square, triangle, DC level, white noise and PRBS.

As well as the basic controls to set level, offset and frequency, more advanced controls allow you to sweep over a range of frequencies. Combined with the spectrum peak hold option, this makes a powerful tool for testing amplifier and filter responses.

Trigger tools allow you to output one or more cycles of a waveform when various conditions are met, such as the scope triggering or a mask limit test failing.

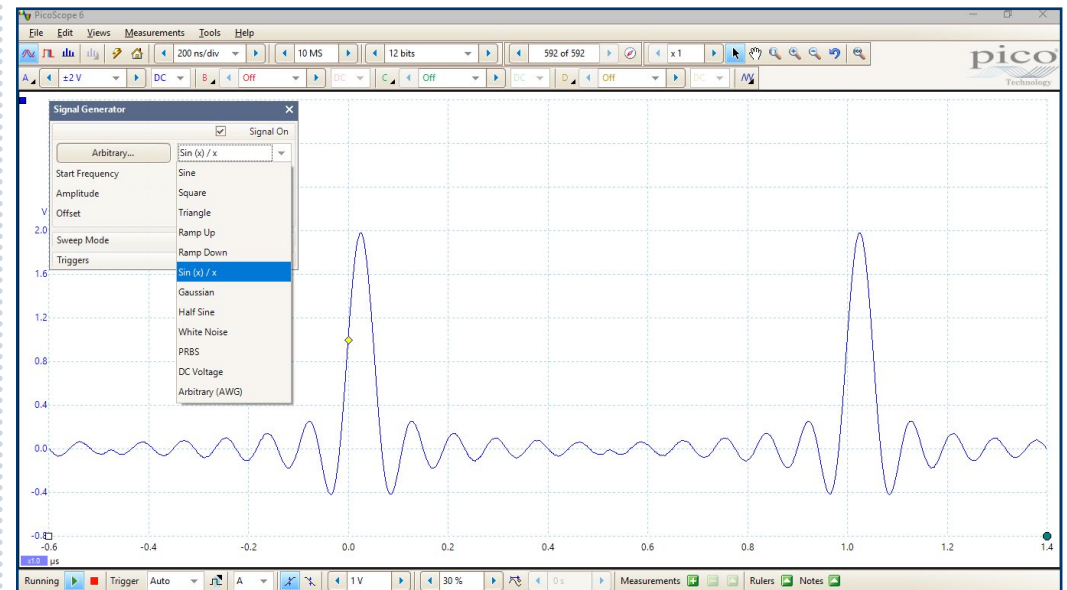

## Serial decoding and analysis

With its deep memory, the PicoScope 5000D Series is ideally suited to serial decoding and analysis, which are included as standard.

The PicoScope 6 software has support for 20 protocols including I<sup>2</sup>C, SPI, CAN, RS-232 and Ethernet (and more in development).

Decoding helps you see what is happening in your design to identify programming and timing errors and check for other signal integrity issues. Timing analysis tools help to show the performance of each design element, identifying parts of the design that need to be improved to optimize overall system performance.

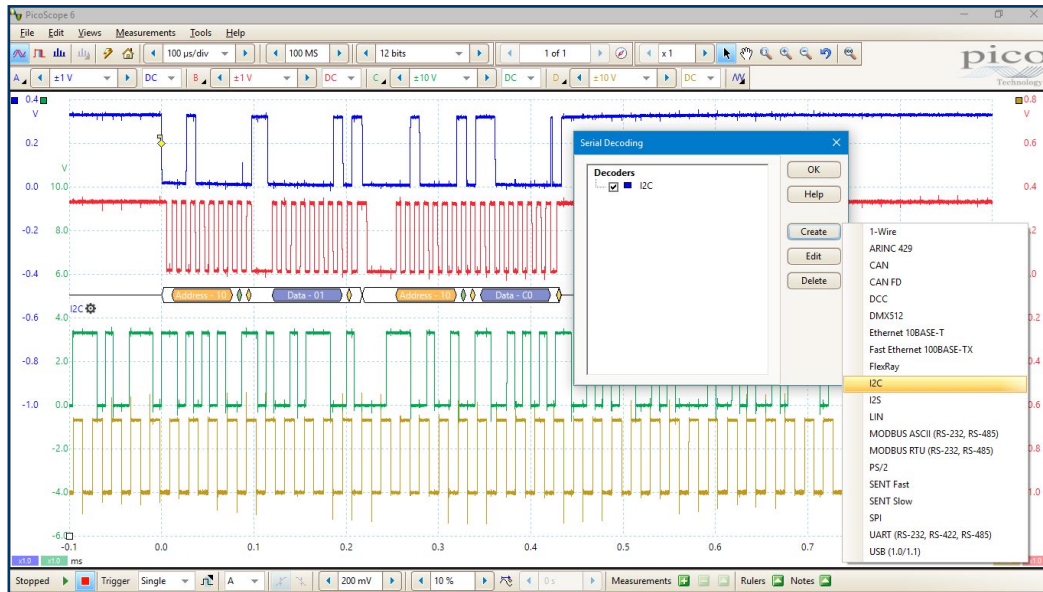

Graph format shows the decoded data (in hex, binary, decimal or ASCII) in a timing diagram format, beneath the waveform on a common time axis, with error frames marked in red.

You can zoom in on these frames to investigate noise or distortion, and each packet field is assigned a different color, so the data is easy to read.

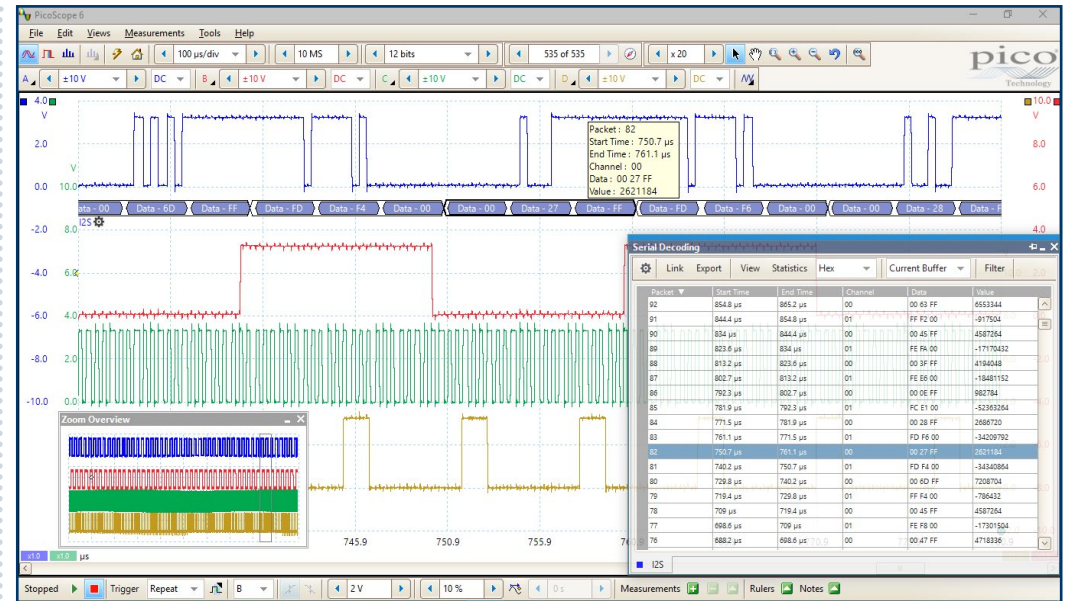

Table format shows a list of the decoded frames, including the data and all flags and identifiers. You can set up filtering conditions to display only the frames you are interested in or search for frames with specified properties.

The statistics option reveals more detail about the physical layer such as frame times and voltage levels. PicoScope 6 can also import a spreadsheet to decode the data into user-defined text strings.

## Spectrum analyzer

The spectrum view plots amplitude against frequency and is ideal for finding noise, crosstalk or distortion in signals. PicoScope 6 uses a fast Fourier transform (FFT) spectrum analyzer, which (unlike a traditional swept spectrum analyzer) can display the spectrum of a single, non-repeating waveform.

With a click of a button, you can display a spectrum plot of the active channels, with a maximum frequency of up to 200 MHz. A comprehensive range of settings gives you control over the number of spectrum bins, window functions, scaling (including log/log) and display mode (instantaneous, average or peak-hold).

Display multiple spectrum views with different channel selections and zoom factors, and place these alongside time-domain views of the same data. Choose from a number of automatic frequency-domain measurements to add to the display, including THD, THD+N, SNR, SINAD and IMD. You can apply mask limit testing to a spectrum and can even use the AWG and spectrum mode together to perform swept scalar network analysis.

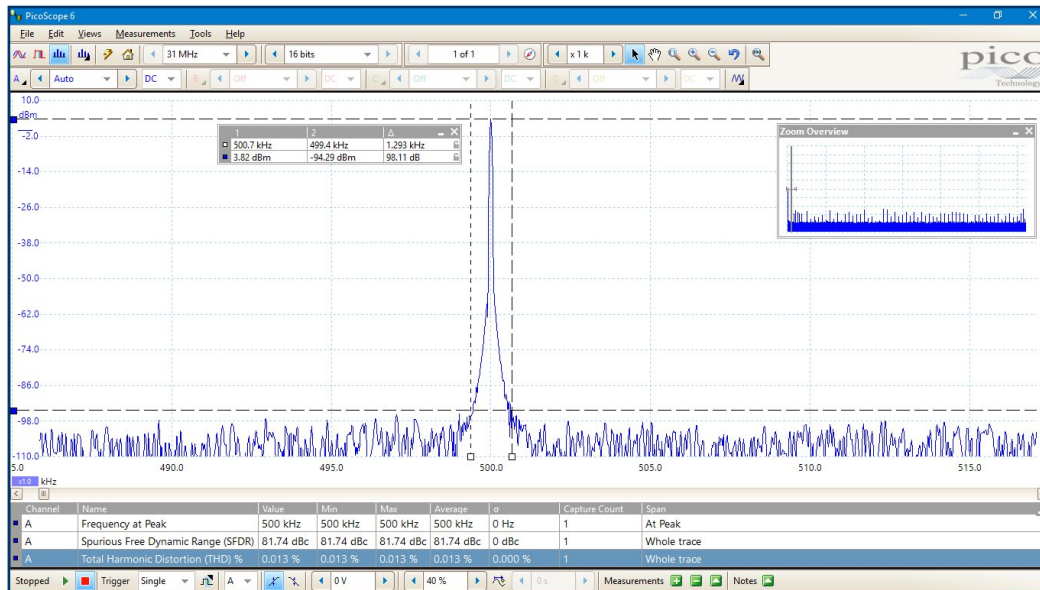

## Advanced triggers

The PicoScope 5000D Series offers an industry-leading set of advanced triggers including pulse width, runt pulse, windowed and dropout.

The digital trigger available on MSO models allows you to trigger the scope when any or all of the 16 digital inputs match a user-defined pattern. You can specify a condition for each channel individually, or set up a pattern for all channels at once using a hexadecimal or binary value.

You can also use the logic trigger to combine the digital trigger with an edge or

window trigger on any of the analog inputs, for example to trigger on data values in a clocked parallel bus.

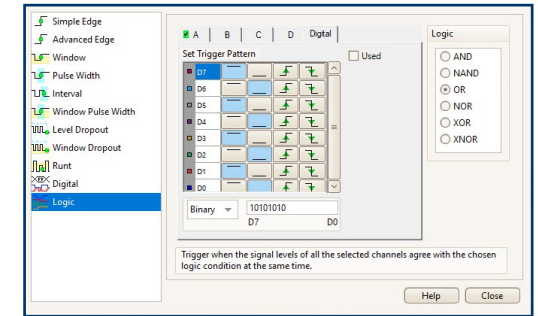

## Digital triggering architecture

In 1991, Pico Technology pioneered the use of digital triggering and precision hysteresis using the actual digitized data. Traditionally, digital oscilloscopes have used an analog trigger architecture based on comparators, which can cause time and amplitude errors that cannot always be calibrated out. Additionally, the use of comparators can often limit the trigger sensitivity at high bandwidths and can create a long trigger rearm delay.

Pico's technique of fully digital triggering reduces trigger errors and allows our oscilloscopes to trigger on the smallest signals, even at the full bandwidth, so you can set trigger levels and hysteresis with high precision and resolution.

The digital trigger architecture also reduces the rearm delay. Combined with the segmented memory, this enables you to use rapid triggering to capture 10 000 waveforms in 10 ms in 8-bit mode.

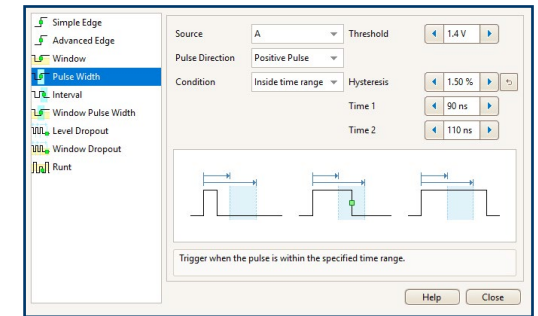

## Mask limit testing

Mask limit testing allows you to compare live signals against known good signals, and is designed for production and debugging environments. Simply capture a known good signal, generate a mask around it and then use the alarms to automatically save any waveform (complete with a time stamp) that violates the mask. PicoScope 6 will capture any intermittent glitches and show a failure count in the Measurements window (which you can still use for other measurements). You can also set the waveform buffer navigator to show only mask fails, enabling you to find any glitches quickly.

Mask files are easy to edit (numerically or graphically), import and export, and you can simultaneously run mask limit tests on multiple channels and in multiple viewports.

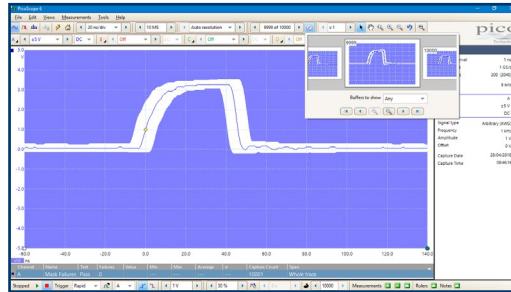

## Alarms

You can program PicoScope 6 to execute actions when certain events occur.

The events that can trigger an alarm include mask limit fails, trigger events and buffers full.

PicoScope 6 actions include saving a file, playing a sound, executing a program and triggering the arbitrary waveform generator.

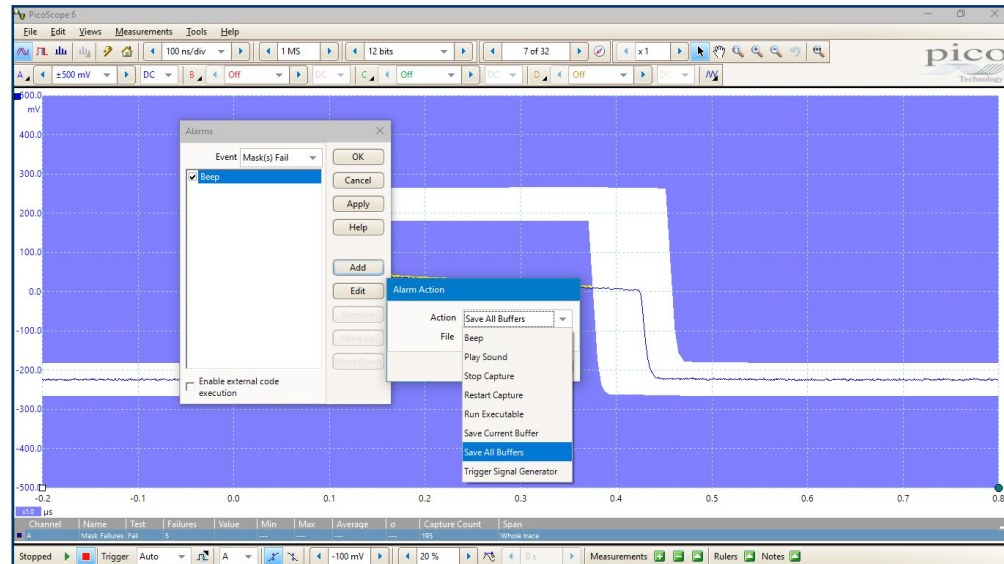

## Math channels and filters

With PicoScope 6 you can perform a variety of mathematical calculations on your input signals and reference waveforms. Select simple functions such as addition and inversion, or open the equation editor to create complex functions involving filters (lowpass, highpass, bandpass and bandstop filters), trigonometry, exponentials, logarithms, statistics, integrals and derivatives.

Display up to eight real or calculated channels in each scope view. If you run out of space, just open another scope view and add more. You can also use math channels to reveal new details in complex signals, for example graphing the changing duty cycle or frequency of your signal over time.

## Custom probes

The custom probes feature allows you to correct for gain, attenuation, offsets and nonlinearities in probes, transducers and other sensors, and to measure quantities other than voltages (such as current, power or temperature). Definitions for standard Pico-supplied probes are built in, but you can also create your own using linear scaling or even an interpolated data table, and save them for later use.

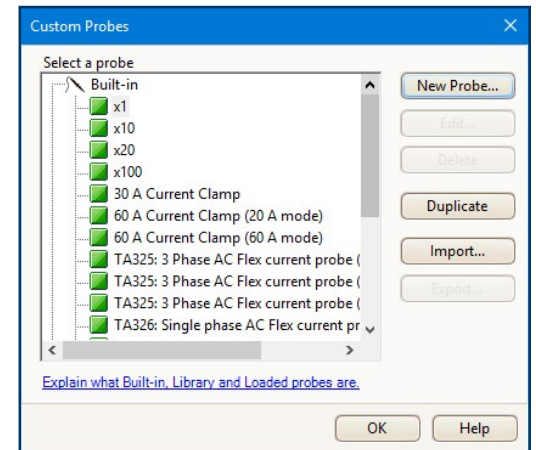
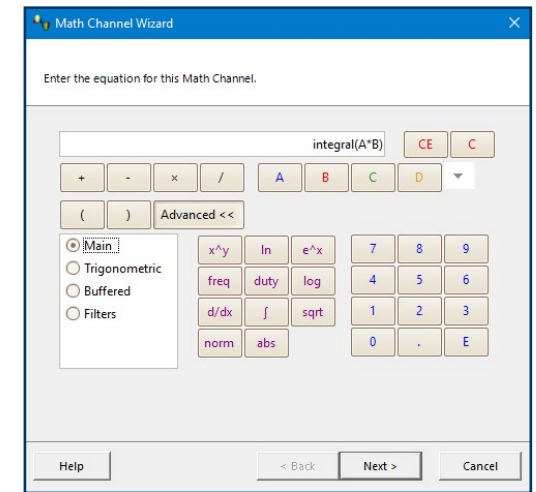



## PicoLog® 6 software

PicoScope 5000D Series oscilloscopes are also supported by the PicoLog 6 data logging software, allowing you to view and record signals on multiple units in one capture.

PicoLog 6 allows sample rates of up to 1 kS/s per channel, and is ideal for long-term observation of general parameters, such as voltage or current levels, on several channels at the same time, whereas the PicoScope 6 software is more suitable for waveshape or harmonic analysis.

You can also use PicoLog 6 to view data from your oscilloscope alongside a data logger or other device. For example, you could measure voltage and current with your PicoScope and plot both against temperature using a [TC-08 thermocouple data logger](#), or humidity with a [DrDAQ multipurpose data logger](#).

PicoLog 6 is available for Windows, macOS and Linux, including Raspberry Pi OS.

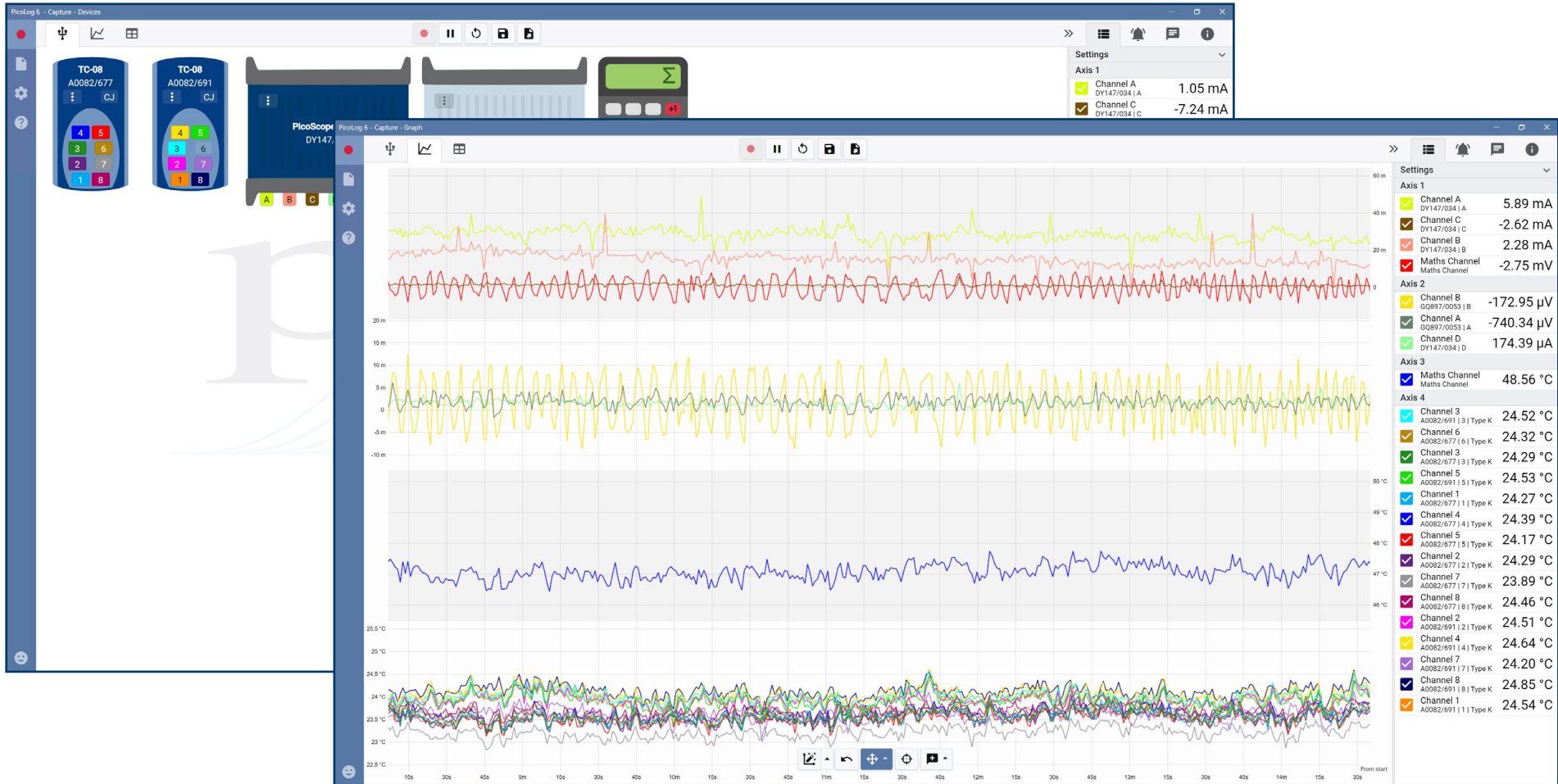

## FlexRes – how we do it

Most digital oscilloscopes gain their high sampling rates by interleaving multiple 8-bit ADCs. Despite careful design, the interleaving process introduces errors that always make the dynamic performance worse than the performance of the individual ADC cores. The FlexRes architecture employs multiple high-resolution ADCs at the input channels in different time-interleaved and parallel combinations to optimize either the sampling rate to 1 GS/s at 8 bits, the resolution to 16 bits at 62.5 MS/s, or other combinations in between. Coupled with high signal-to-noise ratio amplifiers and a low-noise system architecture, FlexRes

technology enables PicoScope 5000D Series oscilloscopes to capture and display signals up to 200 MHz with a high sampling rate, or lower-speed signals with 256 times more resolution than typical 8-bit oscilloscopes. Resolution enhancement—a digital signal processing technique built into PicoScope 6—can further increase the effective vertical resolution of the scope to 20 bits.

The PicoScope 6 software lets you choose between setting the resolution manually and leaving the scope in “auto resolution” mode, where the optimal resolution is used for the chosen settings.

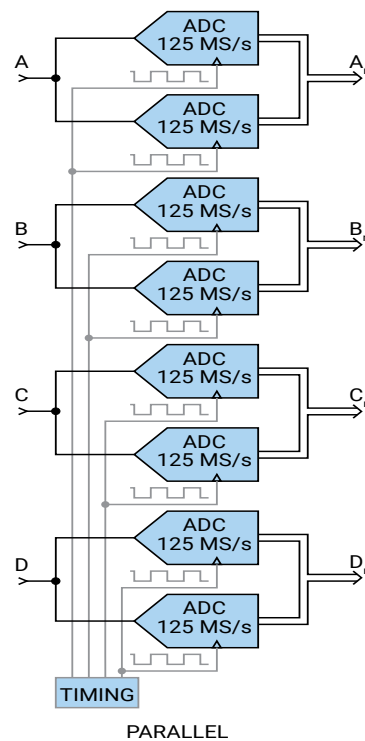
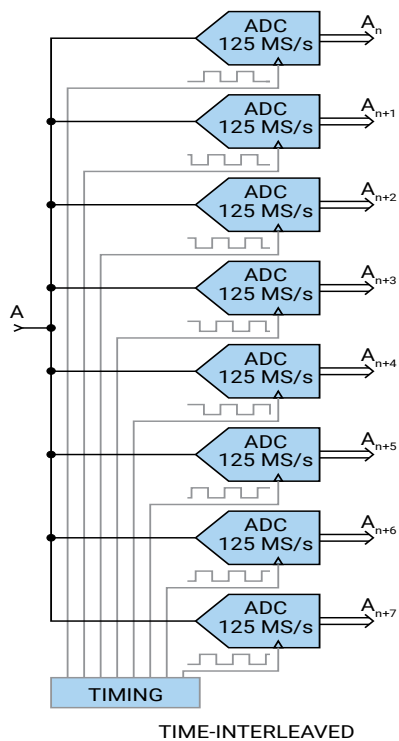

## High signal integrity

Here at Pico, we're proud of the dynamic performance of our products. Careful front-end design and shielding reduces noise, crosstalk and harmonic distortion. Over 25 years of high-resolution oscilloscope design experience leads to improved pulse response and bandwidth flatness.

Sensitivity at 1:1 zoom is an impressive 2 mV/div at the full resolution of the oscilloscope. If you need even more sensitivity, simply switch to high-resolution mode and zoom in. Combining 14-bit mode and zoom can provide 200  $\mu$ V/div sensitivity while still providing more than 8 bits usable resolution.



## SuperSpeed USB 3.0 connection

PicoScope 5000D Series oscilloscopes feature a USB 3.0 connection, providing lightning-fast saving of waveforms while retaining compatibility with older USB standards. The PicoSDK software development kit supports continuous streaming to the host computer at rates up to 125 MS/s.

## PicoSDK® - write your own apps

Our software development kit, PicoSDK, allows you to write your own software and includes drivers for Windows, macOS and Linux. Example code supplied on our GitHub organization page shows how to interface to third-party software packages such as National Instruments LabVIEW and MathWorks MATLAB.

Amongst other features, the drivers support data streaming, a mode that captures continuous gap-free data directly to your PC at rates of up to 125 MS/s,

so you are not limited by the size of your scope's capture memory. Sampling rates in streaming mode are subject to PC specifications and application loading.

There is also an active community of PicoScope 6 users who share both code and whole applications on our Test and Measurement Forum and the PicoApps section of the website. The Frequency Response Analyzer shown here is one of the most popular of these applications.



## Probes, cables and clips

Your PicoScope 5000D Series oscilloscope kit comes with probes specifically trimmed to match the performance of your oscilloscope.

MSO models are also supplied with an MSO cable and 20 test clips.

## Kit contents and accessories

Your PicoScope 5000D Series oscilloscope kit contains the following items:

- PicoScope 5000D Series oscilloscope
- 1 x TA155 Pico blue USB 3 cable 1.8 m
- 60 MHz models: 2/4 x TA375 probes
- 100 MHz models: 2/4 x TA375 probes
- 200 MHz models: 2/4 x TA386 probes
- 4-channel models: 1 x PS011 5 V 3.0 A PSU
- MSO models: 1 x TA136 MSO cable
- MSO models: 2 x TA139 set of MSO clips
- Quick start guide



- Oscilloscope probe



- 20-way 25 cm digital MSO cable

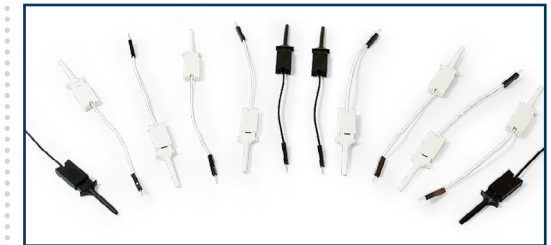

- MSO test clips

Part numbers:

100 MHz probe	200 MHz probe	MSO cable	12 test clips
TA375	TA386	TA136	TA139

# Input and output connections

## 2-channel models

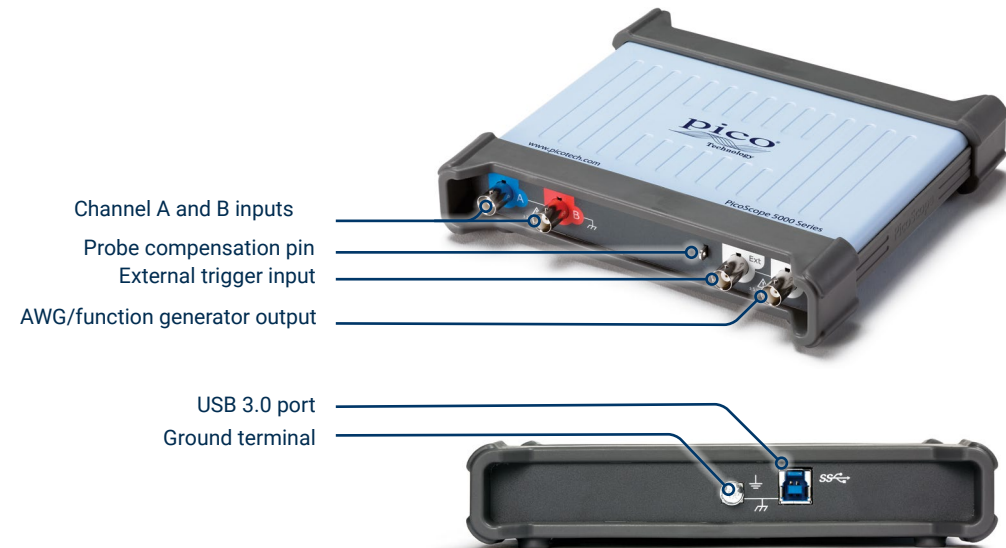

## 2-channel MSO models

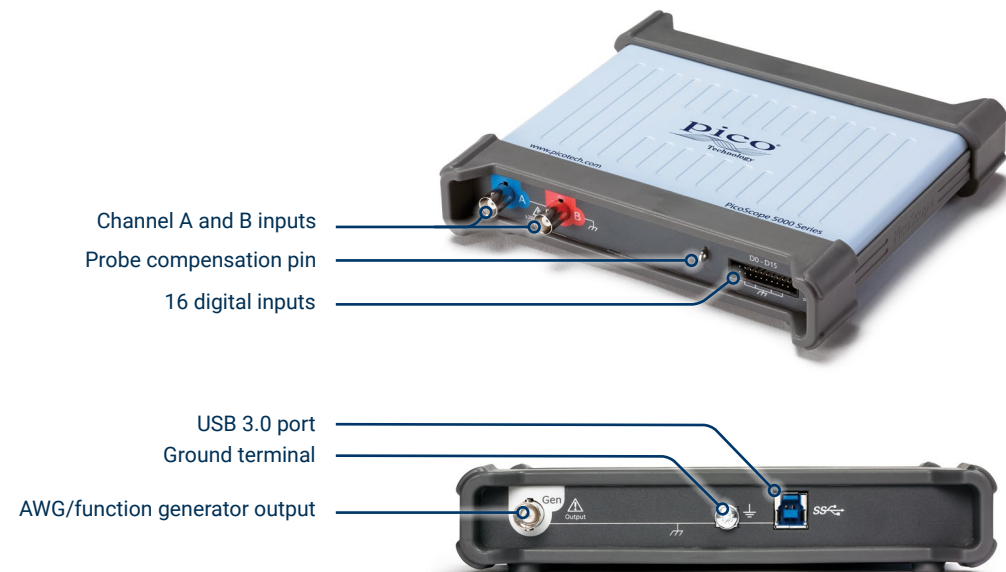

## 4-channel models

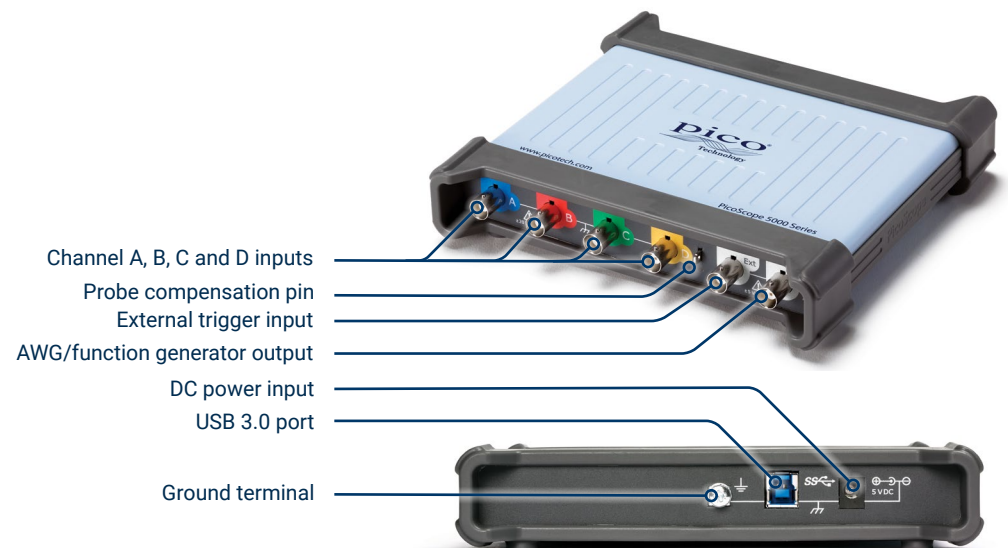

## 4-channel MSO models

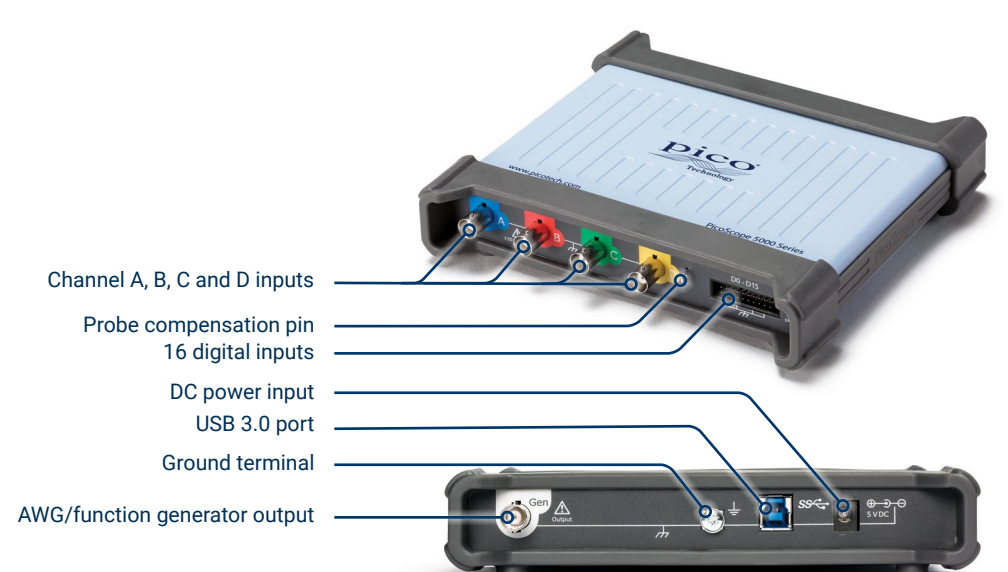

## PicoScope 6 software

The display can be as simple or as advanced as you need. Begin with a single view of one channel, and then expand the display to include any number of live channels, math channels and reference waveforms.

### Auto setup button:

Configures the collection time and voltage range for clear display of signals.

### Channel options:

Filtering, offset, resolution enhancement, custom probes and more.

### Oscilloscope controls:

Controls such as voltage range, scope resolution, channel enable, timebase and memory depth.

**Movable axes:** The vertical axes can be dragged up and down. This feature is particularly useful when one waveform is obscuring another. There's also an **Auto Arrange Axes** command.

**Zoom overview:** Click and drag for quick navigation in zoomed views.

**Tools:** Including serial decoding, reference channels, macro recorder, alarms, mask limit testing and math channels.

**Waveform replay tools:** PicoScope 6 automatically records up to 10,000 of the most recent waveforms. You can quickly scan through to look for intermittent events, or use the **Buffer Navigator** to search visually.

**Signal generator:** Generates standard signals or arbitrary waveforms. Includes frequency sweep mode.

**Zoom and pan tools:** PicoScope 6 allows a zoom factor of several million, which is necessary when working with the deep memory of the 5000D Series scopes.

**Ruler legend:** Absolute and differential ruler measurements are listed here.

**Rulers:** Each axis has two rulers that can be dragged across the screen to make quick measurements of amplitude, time and frequency.

**Views:** PicoScope 6 is carefully designed to make the best use of the display area. You can add new scope, spectrum and XY views with automatic or custom layouts.

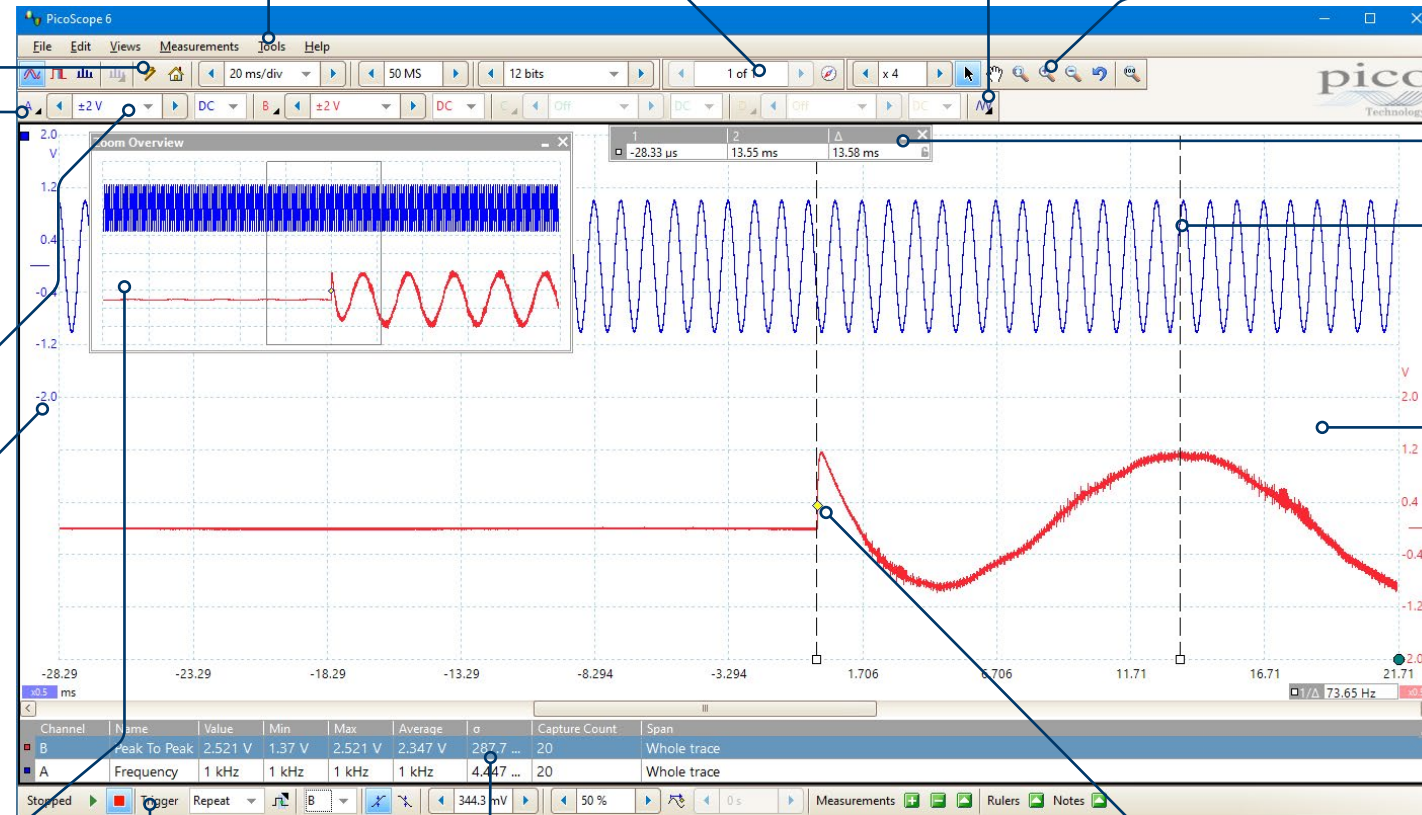

**Trigger toolbar:** Quick access to main controls, with advanced triggers in a pop-up window.

**Automatic measurements:** Display calculated measurements for troubleshooting and analysis. You can add as many measurements as you need on each view. Each measurement includes statistical parameters showing its variability.

**Trigger marker:** Drag the yellow diamond to adjust trigger level and pre-trigger time.

## Mixed-signal models

The PicoScope 5000 MSO models add 16 digital channels to the two or four analog channels, enabling you to accurately time-correlate analog and digital channels. Digital channels may be grouped and displayed as a bus, with each bus value displayed in hex, binary or decimal or as a level (for DAC testing). You can set advanced triggers across both the analog and digital channels.

The digital inputs also bring extra power to the serial decoding options. You can decode serial data on all analog and digital channels simultaneously, giving you up to 20 channels of data – for example decoding multiple SPI, I<sup>2</sup>C, CAN bus, LIN bus and FlexRay signals all at the same time.

### Oscilloscope controls:

PicoScope's full analog-domain controls, including zoom, filtering, and function generator, are all available in MSO digital signal mode.

**Rename:** The digital channels and groups can be renamed. You can expand or collapse groups in the digital view.

**Advanced triggers:** Additional Digital and Logic trigger options are available for digital channels.

### Analog waveforms:

View analog waveforms time-correlated with digital inputs.

### Split-screen display:

PicoScope can display both analog and digital signals at the same time. The split-screen display can be adjusted to give more or less space to the analog waveforms.

### Digital channels button:

Set up and display digital inputs. View analog and digital signals on the same timescale.

**Rulers:** Drawn across both analog and digital panes so signal timings can be compared.

**Groups:** Group bits into fields and optionally display as an analog level.

**Display format:** Display selected bits individually or as groups in binary, hex or decimal format.

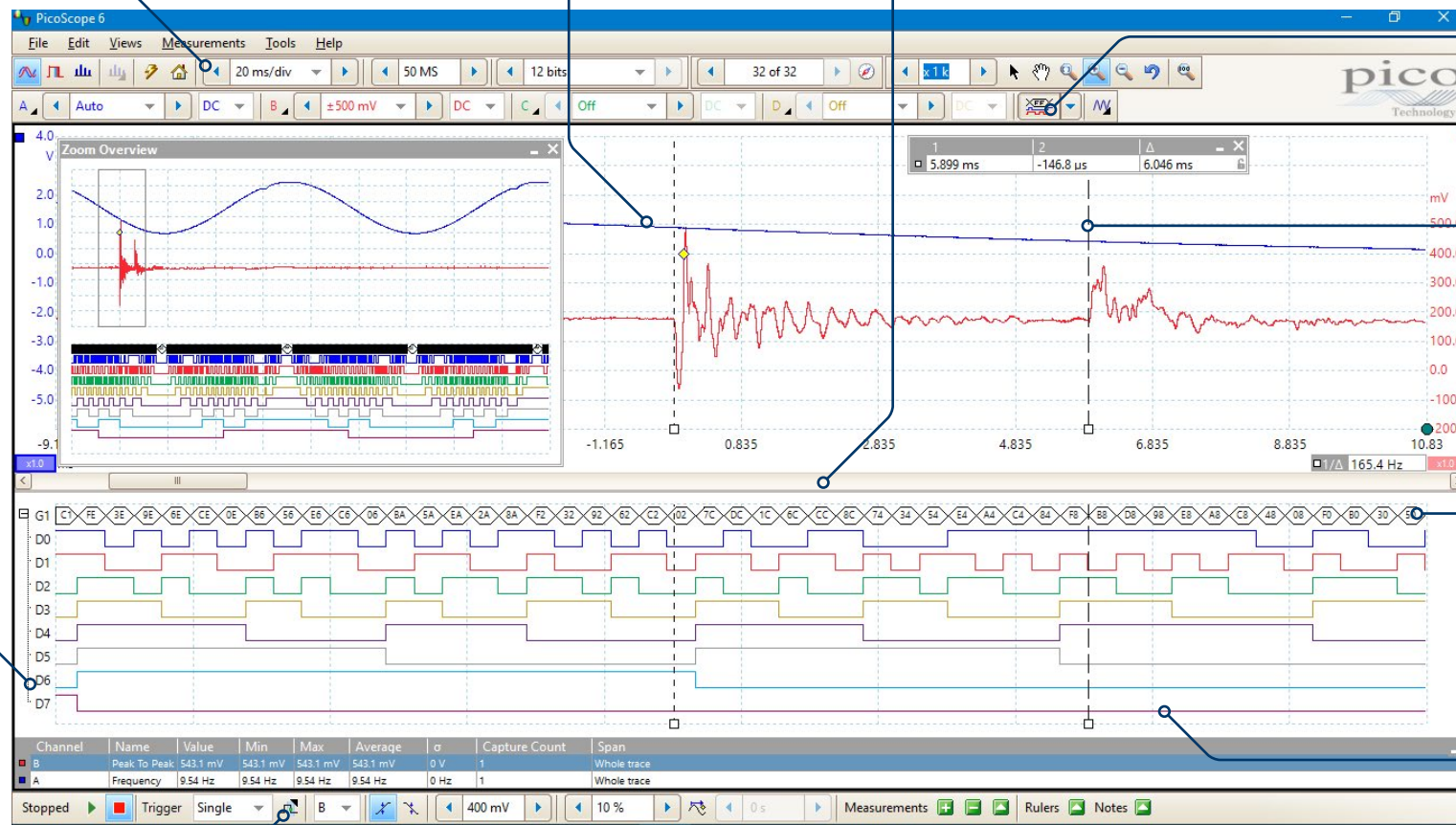

PicoScope 5000D Series Technical Specifications	PicoScope 5242D and 5242D MSO 2-channel, 60 MHz	PicoScope 5442D and 5442D MSO 4-channel, 60 MHz	PicoScope 5243D and 5243D MSO 2-channel, 100 MHz	PicoScope 5443D and 5443D MSO 4-channel, 100 MHz	PicoScope 5244D and 5244D MSO 2-channel, 200 MHz	PicoScope 5444D and 5444D MSO 4-channel, 200 MHz
<b>Vertical (analog channels)</b>						
Analog input channels	2	4	2	4	2	4
Input type	Single-ended, BNC(f) connector					
Bandwidth (-3 dB)	60 MHz		100 MHz <sup>[1]</sup>		200 MHz <sup>[1]</sup>	
Rise time (calculated)	5.8 ns		3.5 ns <sup>[1]</sup>		1.75 ns <sup>[1]</sup>	
Bandwidth limiter	20 MHz, selectable					
Vertical resolution <sup>[2]</sup>	8, 12, 14, 15 or 16 bits					
LSB size (quantization step size) <sup>[2]</sup>	8-bit mode: < 0.6% of input range 12-bit mode: < 0.04% of input range 14-bit mode: < 0.01% of input range 15-bit mode: < 0.005% of input range 16-bit mode: < 0.0025% of input range					
Enhanced vertical resolution	Hardware resolution + 4 bits					
Input ranges	±10 mV to ±20 V full scale, in 11 ranges					
Input sensitivity	2 mV/div to 4 V/div (10 vertical divisions)					
Input coupling	AC / DC					
Input characteristics	1 MΩ ±1%    14 ±1 pF					
Gain accuracy	12 to 16-bit modes: ±0.5% of signal ±1 LSB <sup>[3]</sup> 8-bit mode: ±2% of signal ±1 LSB <sup>[3]</sup>					
Offset accuracy	±500 μV ±1% of full scale <sup>[3]</sup> Offset accuracy can be improved by using the zero offset function in PicoScope 6.					
Analog offset range (vertical position adjust)	±250 mV (10, 20, 50, 100, 200 mV ranges) ±2.5 V (500 mV, 1 V, 2 V ranges) ±20 V (5, 10, 20 V ranges)					
Analog offset control accuracy	±0.5% of offset setting, additional to basic DC offset accuracy					
Overvoltage protection	±100 V (DC + AC peak)					
<sup>[1]</sup> In 16-bit mode, bandwidth reduced to 60 MHz and rise time increased to 5.8 ns.						
<sup>[2]</sup> On ±20 mV range, in 14 to 16-bit modes, hardware resolution reduced by 1 bit. On ±10 mV range, hardware resolution reduced by 1 bit in 12-bit mode, 2 bits in 14 to 16-bit modes.						
<sup>[3]</sup> Between 15 and 30 °C after 1 hour warm-up.						
<b>Vertical (digital channels) – D MSO models only</b>						
Input channels	16 channels (2 ports of 8 channels each)					
Input connector	2.54 mm pitch, 10 x 2 way connector					
Maximum input frequency	100 MHz (200 Mbit/s)					
Minimum detectable pulse width	5 ns					

PicoScope 5000D Series Technical Specifications	PicoScope 5242D and 5242D MSO 2-channel, 60 MHz	PicoScope 5442D and 5442D MSO 4-channel, 60 MHz	PicoScope 5243D and 5243D MSO 2-channel, 100 MHz	PicoScope 5443D and 5443D MSO 4-channel, 100 MHz	PicoScope 5244D and 5244D MSO 2-channel, 200 MHz	PicoScope 5444D and 5444D MSO 4-channel, 200 MHz
Input impedance	200 kΩ ±2%    8 pF ±2 pF					
Input dynamic range	±20 V					
Threshold range	±5 V					
Threshold grouping	Two independent threshold controls. Port 0: D0 to D7, Port 1: D8 to D15					
Threshold selection	TTL, CMOS, ECL, PECL, user-defined					
Threshold accuracy	< ±350 mV including hysteresis					
Threshold hysteresis	< ±250 mV					
Minimum input voltage swing	500 mV peak to peak					
Channel-to-channel skew	2 ns, typical					
Minimum input slew rate	10 V/μs					
Overvoltage protection	±50 V (DC + AC peak)					
<b>Horizontal</b>						
Maximum sampling rate	8-bit mode	12-bit mode	14-bit mode	15-bit mode <sup>[4]</sup>	16-bit mode <sup>[4]</sup>	
Any 1 channel	1 GS/s	500 MS/s	125 MS/s	125 MS/s	62.5 MS/s	
Any 2 channels	500 MS/s	250 MS/s	125 MS/s	125 MS/s		
Any 3 or 4 channels	250 MS/s	125 MS/s	125 MS/s	125 MS/s		
More than 4 channels	125 MS/s	62.5 MS/s	62.5 MS/s	62.5 MS/s		
	"Channel" means any analog channel or 8-bit digital port.					
Maximum equivalent sampling rate (repetitive signals; 8-bit mode only, ETS mode)	2.5 GS/s		5 GS/s		10 GS/s	
Maximum sampling rate (continuous USB streaming into PC memory) <sup>[5]</sup>	USB 3, using PicoScope 6: USB 3, using PicoSDK: USB 2, using PicoScope 6: USB 2, using PicoSDK:	15 to 20 MS/s 125 MS/s (8-bit mode) or 62.5 MS/s (12 to 16-bit modes) 8 to 10 MS/s ~30 MS/s (8-bit mode) or ~15 MS/s (12 to 16-bit modes)				
Timebase ranges (real-time)	1 ns/div to 5000 s/div in 39 ranges					
Fastest timebase (ETS)	500 ps/div		200 ps/div		100 ps/div	
Buffer memory <sup>[6]</sup> (8-bit)	128 MS		256 MS		512 MS	
Buffer memory <sup>[6]</sup> (≥ 12-bit)	64 MS		128 MS		256 MS	
Buffer memory <sup>[7]</sup> (continuous streaming)	100 MS in PicoScope 6 software					
Waveform buffer (no. of segments)	10 000 in PicoScope 6 software					
Waveform buffer (no. of segments) when using PicoSDK (8 bits)	250 000		500 000		1 000 000	



PicoScope 5000D Series Technical Specifications	PicoScope 5242D and 5242D MSO 2-channel, 60 MHz	PicoScope 5442D and 5442D MSO 4-channel, 60 MHz	PicoScope 5243D and 5243D MSO 2-channel, 100 MHz	PicoScope 5443D and 5443D MSO 4-channel, 100 MHz	PicoScope 5244D and 5244D MSO 2-channel, 200 MHz	PicoScope 5444D and 5444D MSO 4-channel, 200 MHz
Waveform buffer (no. of segments) when using PicoSDK (12 to 16 bits)	125 000		250 000		500 000	
Initial timebase accuracy	±50 ppm (0.005%)		±2 ppm (0.0002%)		±2 ppm (0.0002%)	
Timebase drift	±5 ppm/year		±1 ppm/year		±1 ppm/year	
Sample jitter	3 ps RMS, typical					
ADC sampling	Simultaneous on all enabled channels.					
<sup>[4]</sup> Any number of 8-bit digital ports can be used in 15-bit and 16-bit modes without affecting the maximum sampling rate.						
<sup>[5]</sup> Shared between enabled channels, PC dependent, available sample rates vary by resolution.						
<sup>[6]</sup> Shared between enabled channels.						
<sup>[7]</sup> Driver buffering up to available PC memory when using PicoSDK. No limit on duration of capture.						
<b>Dynamic performance (typical, analog channels)</b>						
Crosstalk	Better than 400:1 up to full bandwidth (equal voltage ranges).					
Harmonic distortion	8-bit mode: -60 dB at 100 kHz full scale input 12 to 16-bit modes: -70 dB at 100 kHz full scale input					
SFDR	8 to 12-bit modes: 60 dB at 100 kHz full scale input 14 to 16-bit modes: 70 dB at 100 kHz full scale input					
Noise (on ±10 mV range)	8-bit mode: 120 µV RMS 12-bit mode: 110 µV RMS 14-bit mode: 100 µV RMS 15-bit mode: 85 µV RMS 16-bit mode: 70 µV RMS					
Bandwidth flatness	(+0.3 dB, -3 dB) from DC to full bandwidth					
<b>Triggering (main specifications)</b>						
Source	Analog channels, plus: MSO models: Digital D0 to D15; other models: Ext trigger					
Trigger modes	None, auto, repeat, single, rapid (segmented memory)					
Advanced trigger types (analog channels)	Edge, window, pulse width, window pulse width, dropout, window dropout, interval, runt, logic					
Trigger types (analog channels, ETS)	Rising or falling edge ETS trigger available on ChA only, 8-bit mode only					
Trigger sensitivity (analog channels)	Digital triggering provides 1 LSB accuracy up to full bandwidth of scope					
Trigger sensitivity (analog channels, ETS)	At full bandwidth: typical 10 mV peak to peak					
Trigger types (digital inputs)	MSO models only: Edge, pulse width, dropout, interval, logic, pattern, mixed signal					
Maximum pre-trigger capture	Up to 100% of capture size.					

PicoScope 5000D Series Technical Specifications	PicoScope 5242D and 5242D MSO 2-channel, 60 MHz	PicoScope 5442D and 5442D MSO 4-channel, 60 MHz	PicoScope 5243D and 5243D MSO 2-channel, 100 MHz	PicoScope 5443D and 5443D MSO 4-channel, 100 MHz	PicoScope 5244D and 5244D MSO 2-channel, 200 MHz	PicoScope 5444D and 5444D MSO 4-channel, 200 MHz
Maximum post-trigger delay	Zero to 4 billion samples, settable in 1 sample steps (delay range on fastest timebase of 0 to 4 s in 1 ns steps)					
Trigger rearm time	8-bit mode, typical: 1 $\mu$ s on fastest timebase 8 to 12-bit modes: < 2 $\mu$ s max on fastest timebase 14 to 16-bit modes: < 3 $\mu$ s max on fastest timebase					
Maximum trigger rate	10 000 waveforms in a 10 ms burst, 8-bit mode					
<b>External trigger input – not MSO models</b>						
Connector type	Front panel BNC(f)					
Trigger types	Edge, pulse width, dropout, interval, logic					
Input characteristics	1 M $\Omega$ $\pm$ 1%    14 pF $\pm$ 1.5 pF					
Bandwidth	60 MHz		100 MHz		200 MHz	
Threshold range	$\pm$ 5 V					
External trigger threshold accuracy	$\pm$ 1% of full scale					
External trigger sensitivity	200 mV peak to peak					
Coupling	DC					
Overvoltage protection	$\pm$ 100 V (DC + AC peak)					
<b>Function generator</b>						
Standard output signals	Sine, square, triangle, DC voltage, ramp up, ramp down, sinc, Gaussian, half-sine					
Pseudorandom output signals	White noise, selectable amplitude and offset within output voltage range. Pseudorandom binary sequence (PRBS), selectable high and low levels within output voltage range, selectable bit rate up to 20 Mb/s					
Output frequency	0.025 Hz to 20 MHz					
Sweep modes	Up, down, dual with selectable start / stop frequencies and increments					
Triggering	Can trigger a counted number of waveform cycles or frequency sweeps (from 1 to 1 billion) from the scope trigger, external trigger (non-MSO models only) or from software. Can also use the external trigger to gate the signal generator output.					
Output frequency accuracy	Oscilloscope timebase accuracy $\pm$ output frequency resolution					
Output frequency resolution	< 0.025 Hz					
Output voltage range	$\pm$ 2 V					
Output voltage adjustments	Signal amplitude and offset adjustable in approx 0.25 mV steps within overall $\pm$ 2 V range					
Amplitude flatness	< 1.5 dB to 20 MHz, typical					
DC accuracy	$\pm$ 1% of full scale					
SFDR	> 70 dB, 10 kHz full scale sine wave					
Output resistance	50 $\Omega$ $\pm$ 1%					
Connector type	BNC(f)					
Overvoltage protection	$\pm$ 20 V					

PicoScope 5000D Series Technical Specifications	PicoScope 5242D and 5242D MSO 2-channel, 60 MHz	PicoScope 5442D and 5442D MSO 4-channel, 60 MHz	PicoScope 5243D and 5243D MSO 2-channel, 100 MHz	PicoScope 5443D and 5443D MSO 4-channel, 100 MHz	PicoScope 5244D and 5244D MSO 2-channel, 200 MHz	PicoScope 5444D and 5444D MSO 4-channel, 200 MHz
<b>Arbitrary waveform generator</b>						
Update rate	200 MS/s					
Buffer size	32 kS					
Resolution	14 bits (output step size approx 0.25 mV)					
Bandwidth (-3 dB)	> 20 MHz					
Rise time (10% to 90%)	<10 ns (50 $\Omega$ load)					
Other AWG specifications including sweep modes, triggering, frequency accuracy and resolution, voltage range, DC accuracy and output characteristics are as function generator.						
<b>Probe compensation pin</b>						
Output characteristics	600 $\Omega$					
Output frequency	1 kHz					
Output level	3 V peak to peak, typical					
Overvoltage protection	10 V					
<b>Spectrum analyzer</b>						
Frequency range	DC to 60 MHz		DC to 100 MHz		DC to 200 MHz	
Display modes	Magnitude, average, peak hold					
Y axis	Logarithmic (dBV, dBu, dBm, arbitrary dB) or linear (volts)					
X axis	Linear or logarithmic					
Windowing functions	Rectangular, Gaussian, triangular, Blackman, Blackman-Harris, Hamming, Hann, flat-top					
Number of FFT points	Selectable from 128 to 1 million in powers of 2					
<b>Math channels</b>						
Functions	-x, x+y, x-y, x*y, x/y, x^y, sqrt, exp, ln, log, abs, norm, sign, sin, cos, tan, arcsin, arccos, arctan, sinh, cosh, tanh, delay, average, frequency, derivative, integral, min, max, peak, duty, highpass, lowpass, bandpass, bandstop					
Operands	A, B, C, D (input channels), T (time), reference waveforms, pi, D0-D15 (digital channels), constants					
<b>Automatic measurements</b>						
Scope mode	AC RMS, cycle time, DC average, duty cycle, edge count, fall time, falling edge count, falling rate, frequency, high pulse width, low pulse width, maximum, minimum, negative duty cycle, peak to peak, rise time, rising edge count, rising rate, true RMS					
Spectrum mode	Frequency at peak, amplitude at peak, average amplitude at peak, total power, THD %, THD dB, THD+N, SFDR, SINAD, SNR, IMD					
Statistics	Minimum, maximum, average, standard deviation					
<b>DeepMeasure™</b>						
Parameters	Cycle number, cycle time, frequency, low pulse width, high pulse width, duty cycle (high), duty cycle (low), rise time, fall time, undershoot, overshoot, max. voltage, min. voltage, voltage peak to peak, start time, end time					

PicoScope 5000D Series Technical Specifications	PicoScope 5242D and 5242D MSO 2-channel, 60 MHz	PicoScope 5442D and 5442D MSO 4-channel, 60 MHz	PicoScope 5243D and 5243D MSO 2-channel, 100 MHz	PicoScope 5443D and 5443D MSO 4-channel, 100 MHz	PicoScope 5244D and 5244D MSO 2-channel, 200 MHz	PicoScope 5444D and 5444D MSO 4-channel, 200 MHz
<b>Serial decoding</b>						
Protocols	1-Wire, ARINC 429, CAN & CAN-FD, DALI, DCC, DMX512, Ethernet 10Base-T and 100Base-TX, FlexRay, I <sup>2</sup> C, I <sup>2</sup> S, LIN, PS/2, Manchester, Modbus ASCII, Modbus RTU, SENT, SPI, UART (RS-232 / RS-422 / RS-485), USB 1.1					
<b>Mask limit testing</b>						
Statistics	Pass/fail, failure count, total count					
Mask creation	User-drawn, table entry, auto-generated from waveform or imported from file					
<b>Display</b>						
Interpolation	Linear or sin(x)/x					
Persistence modes	Digital color, analog intensity, custom, fast					
Output file formats	bmp, csv, gif, animated gif, jpg, mat, pdf, png, psdata, pssettings, txt					
Output functions	Copy to clipboard, print					
<b>General</b>						
PC connectivity	USB 3.0 SuperSpeed (USB 2.0 compatible)					
Power requirements	2-channel models: powered from single USB 3.0 port 4-channel models: AC adaptor supplied. Can use 2 channels (plus MSO channels if fitted) powered by USB 3.0 or charging port supplying 1.2 A.					
Dimensions	190 x 170 x 40 mm including connectors					
Weight	< 0.5 kg					
Temperature range	Operating: 0 to 40 °C 15 to 30 °C for quoted accuracy after 1 hour warm-up Storage: -20 to +60 °C					
Humidity range	Operating: 5 to 80 %RH non-condensing Storage: 5 to 95 %RH non-condensing					
Environment	Up to 2000 m altitude and EN 61010 pollution degree 2					
Safety approvals	Designed to EN 61010-1:2010					
EMC approvals	Tested to EN 61326-1:2013 and FCC Part 15 Subpart B					
Environmental approvals	RoHS and WEEE compliant					
Windows software (32-bit or 64-bit) <sup>[8]</sup>	PicoScope 6, PicoLog 6, PicoSDK (Users writing their own apps can find example programs for all platforms on the Pico Technology organization page on <a href="#">GitHub</a> )					
macOS software (64-bit) <sup>[8]</sup>	PicoScope 6 Beta (including drivers), PicoLog 6 (including drivers)					
Linux software (64-bit) <sup>[8]</sup>	PicoScope 6 Beta software and drivers, PicoLog 6 (including drivers) See <a href="#">Linux Software and Drivers</a> to install drivers only					
Raspberry Pi 4B (Raspberry Pi OS) <sup>[8]</sup>	PicoLog 6 (including drivers) See <a href="#">Linux Software and Drivers</a> to install drivers only					

PicoScope 5000D Series Technical Specifications	PicoScope 5242D and 5242D MSO 2-channel, 60 MHz	PicoScope 5442D and 5442D MSO 4-channel, 60 MHz	PicoScope 5243D and 5243D MSO 2-channel, 100 MHz	PicoScope 5443D and 5443D MSO 4-channel, 100 MHz	PicoScope 5244D and 5244D MSO 2-channel, 200 MHz	PicoScope 5444D and 5444D MSO 4-channel, 200 MHz
--	---	---	--	--	--	--

<sup>[8]</sup> See the [picotech.com/downloads](http://picotech.com/downloads) page for more information.

PC requirements	Processor, memory and disk space: as required by the operating system Port(s): USB 3.0 (recommended) or USB 2.0
Languages supported, PicoScope 6	Simplified Chinese, Czech, Danish, Dutch, English, Finnish, French, German, Greek, Hungarian, Italian, Japanese, Korean, Norwegian, Polish, Portuguese, Romanian, Russian, Spanish, Swedish, Turkish
Languages supported, PicoLog 6	Simplified Chinese, Dutch, English (UK), English (US), French, German, Italian, Japanese, Korean, Russian, Spanish

## Ordering information

Order code	Model number	Description
PQ143	PicoScope 5242D	60 MHz 2-channel oscilloscope
PQ149	PicoScope 5242D MSO	60 MHz 2-channel mixed-signal oscilloscope
PQ146	PicoScope 5442D	60 MHz 4-channel oscilloscope
PQ152	PicoScope 5442D MSO	60 MHz 4-channel mixed-signal oscilloscope
PQ144	PicoScope 5243D	100 MHz 2-channel oscilloscope
PQ150	PicoScope 5243D MSO	100 MHz 2-channel mixed-signal oscilloscope
PQ147	PicoScope 5443D	100 MHz 4-channel oscilloscope
PQ153	PicoScope 5443D MSO	100 MHz 4-channel mixed-signal oscilloscope
PQ145	PicoScope 5244D	200 MHz 2-channel oscilloscope
PQ151	PicoScope 5244D MSO	200 MHz 2-channel mixed-signal oscilloscope
PQ148	PicoScope 5444D	200 MHz 4-channel oscilloscope
PQ154	PicoScope 5444D MSO	200 MHz 4-channel mixed-signal oscilloscope
PP969	Carry case	Hard carry case with an internal foam cut-out

## More oscilloscopes in the PicoScope range...

### PicoScope 2000 Series

The pocket-sized PicoScope



### PicoScope 4000 Series

High precision 12 to 16 bits



### PicoScope 6000E Series

High performance Up to 1 GHz



### PicoScope 9000 Series

Sampling scopes and TDR to 25 GHz



#### UK global headquarters:

Pico Technology  
James House  
Colmworth Business Park  
St. Neots  
Cambridgeshire  
PE19 8YP  
United Kingdom

+44 (0) 1480 396 395  
sales@picotech.com

#### North America regional office:

Pico Technology  
320 N Glenwood Blvd  
Tyler  
TX 75702  
United States

+1 800 591 2796  
sales@picotech.com

#### Asia-Pacific regional office:

Pico Technology  
Room 2252, 22/F, Centro  
568 Hengfeng Road  
Zhabei District  
Shanghai 200070  
PR China

+86 21 2226-5152  
pico.asia-pacific@picotech.com

Errors and omissions excepted. *Pico Technology*, *PicoScope*, *PicoLog*, *PicoSDK*, *FlexRes* and *DeepMeasure* are registered trademarks of Pico Technology Ltd.

*LabVIEW* is a trademark of National Instruments Corporation. *Linux* is the registered trademark of Linus Torvalds, registered in the U.S. and other countries. *macOS* is a trademark of Apple Inc., registered in the U.S. and other countries. *MATLAB* is a registered trademark of The MathWorks, Inc. *Windows* is a registered trademark of Microsoft Corporation in the U.S. and other countries. *GitHub* is a registered trademark of GitHub Inc. in the U.S. and other countries.

MM093.en-4. Copyright © 2018–2021 Pico Technology Ltd. All rights reserved.

[www.picotech.com](http://www.picotech.com)



Pico Technology



@LifeAtPico



@picotechnologyLtd



Pico Technology



@picotech