



PicoSource® PG900 Series

Pulse Generators

User's Guide



Contents

| | |
|---|----|
| 1 Introduction | 5 |
| 1 Overview | 5 |
| 2 Minimum PC requirements | 6 |
| 3 Safety information | 6 |
| 1 Symbols | 7 |
| 2 Maximum input/output ranges | 8 |
| 3 Grounding | 9 |
| 4 External connections | 9 |
| 5 Environment | 10 |
| 6 Care of the product | 10 |
| 4 Software licence conditions | 11 |
| 5 Trademarks | 12 |
| 6 Warranty | 12 |
| 2 Product information | 13 |
| 1 What do I get? | 13 |
| 2 Connections | 14 |
| 3 How to use your pulse generator | 16 |
| 1 Connection diagrams | 16 |
| 1 TDR applications | 16 |
| 2 TDT applications | 18 |
| 3 TDT and crosstalk | 19 |
| 2 Free-running operation for SRD integrated pulse outputs | 20 |
| 3 Free-running operation for TD outputs | 22 |
| 4 External trigger operation | 23 |
| 5 Single trigger operation | 24 |
| 4 PicoSource PG900 software | 25 |
| 1 Display area | 25 |
| 1 Intensified Zone | 27 |
| 2 Positive and negative pulse outputs | 28 |
| 3 Tunnel diode pulse head outputs | 30 |
| 4 Tunnel diode pulse head controls | 32 |
| 5 Mode | 33 |
| 6 Timing | 34 |
| 7 External trigger | 36 |
| 8 Trigger output | 39 |
| 9 Display scaling | 40 |
| 1 Vertical Scale | 40 |
| 2 Horizontal Scale | 42 |
| 10 Undo/Redo | 44 |

| | |
|---|-----------|
| 11 Main Menu | 45 |
| 5 Theory of operation | 46 |
| 1 PicoSource PG900 block diagram | 46 |
| 2 Hardware components for PicoSource PG900 models | 47 |
| 6 Specifications and characteristics | 48 |
| 1 PG900 family specifications | 48 |
| 2 Integrated step recovery diode outputs | 49 |
| 3 Drive output with tunnel diode pulse heads | 50 |
| 4 Timing | 51 |
| 5 External trigger input | 52 |
| 6 Trigger output | 53 |
| 7 General | 54 |
| Index | 55 |

1 Introduction

1.1 Overview

The PicoSource PG900 Series instruments are PC-based fast-edge pulse generators that are fully compatible with USB 2.0 and 3.0 PCs. The pulse generators are available in three differential output models and offer extensive control over pulse parameters including amplitude, period, width and deskew between output channels.

- PicoSource PG911:
A two-channel pulse generator based on Step-Recovery Diode (SRD) technology. It produces two pulses with opposite polarity, up to 6 V amplitude with 60 ps rise time.
- PicoSource PG912:
A two-channel pulse generator based on Tunnel Diode (TD) technology. It is supplied with small remote tunnel diode pulse heads that generate positive and negative 200 mV pulses with 40 ps rise time.
- PicoSource PG914:
A four-channel pulse generator based on both SRD and TD technologies. It can produce two pulses with opposite polarity, up to 6 V amplitude with 60 ps rise time, and two pulses with opposite polarity, 200 mV amplitude and 40 ps rise time from remote tunnel diode pulse heads.



PicoSource Pulse Generators are capable of producing pulses of either polarity with very fast rise times. The generators will free-run or may be triggered from an external source, with either positive or negative pulses, at rates of up to 1 MHz. The units are designed to operate into 50 Ω lines.

The PicoSource instruments can be used as:

- general-purpose pulse generators for the testing of semiconductors, components, networks, electro-optical components etc.
- fast rise/fall time step generators which can be used to check the dynamic response of wide-band oscilloscopes and amplifiers
- a stimulus for high-resolution TDR and TDT measurements
- a step source for an ultra-wideband impulse forming network

For basic instructions on installing and using your pulse generator, please refer to [How to use your pulse generator](#) or the Quick Start Guide supplied with your instrument.

Features

- 60 ps rise time at 6 V amplitude (integrated SRD pulse outputs)
- 40 ps rise time at 200 mV amplitude (tunnel diode pulse outputs)
- 1 Hz to 1 MHz repetition rate
- 200 ns to 4 μ s pulse width
- Continuous, external or manual trigger mode
- Differential outputs with deskew
- Low-jitter trigger input and output
- Storage and carry case
- USB 2.0- and 3.0- compatible

1.2 Minimum PC requirements

To ensure that the PicoSource PG900 pulse generator and software operate correctly, you must use a computer with the system requirements and one of the operating systems shown in the table below. The performance of the instrument will be improved with a more powerful PC, and operation will greatly benefit from a multi-core processor.

| | |
|------------------|--|
| Processor | As required by the operating system |
| Memory | |
| Free disk space | Software occupies about 20 MB |
| Operating system | Microsoft Windows XP (SP3), Windows 7, 8, 8.1 (not Windows RT) and 10. 32-bit or 64-bit versions. |
| Ports | USB 2.0 (also compatible with USB 3.0) |

1.3 Safety information

To prevent possible electrical shock, fire, personal injury, or damage to the product, carefully read this safety information before attempting to install or use the product. In addition, follow all generally accepted safety practices and procedures for working with and around electricity.

The product has been designed and tested in accordance with the harmonized standard publication EN 61010-1:2010+A1:2019 (Safety Requirements for Electrical Equipment for Measurement, Control and Laboratory Use) and EN 61010-2-030:2010 (Requirements for Testing and Measuring Circuits). The product left the factory in a safe condition.









The following safety descriptions are found throughout this guide:

A **WARNING** identifies conditions or practices that could result in injury or death.

A **CAUTION** identifies conditions or practices that could result in damage to the product or equipment to which it is connected.

1.3.1 Symbols

These safety and electrical symbols may appear on the product or in this guide.

| Symbol | Description |
|---|---|
|  | Direct current |
|  | Alternating current |
|  | Earth (ground) terminal This terminal can be used to make a measurement ground connection. It is not a safety or protective earth. |
|  | Chassis terminal |
|  | Possibility of electric shock |
|  | Caution Appearance on the product indicates a need to read these safety instructions. |
|  | Static awareness. Static discharge can damage parts. |
|  | Do not dispose of this product as unsorted municipal waste. |



WARNING

To prevent injury or death use the product only as instructed and use only accessories supplied or recommended. Protection provided by the product may be impaired if used in a manner not specified by the manufacturer.

1.3.2 Maximum input/output ranges

Observe all terminal ratings and warnings marked on the product.

The table below indicates the maximum voltage of the outputs and the overvoltage protection range for the trigger input on each pulse generator. The overvoltage protection ranges are the maximum voltages that can be applied without damaging the instrument.

| Connection port | Maximum voltage (output or input) | Overvoltage protection |
|---------------------------------|-----------------------------------|--|
| Integrated pulse outputs | ± 8 V unterminated | ± 10 V Do not connect a source |
| Drive outputs | ± 5 V DC or AC pk | ± 5 V DC or AC pk Do not connect a source |
| Tunnel diode pulse head outputs | 250 mV | 0 V Do not connect a source |
| Trigger input | ± 2 V DC or AC pk | ± 2 V DC or AC pk |
| Trigger output | +3 V DC or AC pk | +4 V / -2 V DC Do not connect a source |



WARNING

To prevent electric shock, do not connect an input voltage to the integrated pulse outputs or the tunnel diode pulse heads.



CAUTION

Exceeding the over-voltage protection range on any connector can cause permanent damage to the instrument and other connected equipment.

CAUTION

To prevent permanent damage, do not apply an input voltage to any of the output channels of the pulse generator.

1.3.3 Grounding



WARNING

The instrument's ground connection through the USB cable is for functional purposes only. The instrument does not have a protective safety ground.

WARNING

To prevent injury or death, never connect the ground of an input or output (chassis) to any electrical power source. To prevent personal injury or death, use a voltmeter to check that there is no significant AC or DC voltage between the pulse generator's ground and the point to which you intend to connect it.



CAUTION

Applying a voltage to the ground input is likely to cause permanent damage to the instrument, the attached computer, and other equipment.

CAUTION

To prevent signal degradation caused by poor grounding, always use the high-quality USB cable supplied with the instrument.

1.3.4 External connections



WARNING

To prevent injury or death, only use the Pico approved adaptor supplied with the product. This is approved for the voltage and plug configuration in your country.

| Power supply options and ratings | | | | |
|----------------------------------|---|---------------------|----------|-------------|
| PicoSource model | USB connection | Ext DC power supply | | |
| | | Voltage | Current | Total power |
| PG900 Series | USB 2.0. Compatible with USB 3.0. | 5 V | 1.6 A pk | 8 W |



CAUTION

Take care to avoid mechanical stress or tight bend radii for all connected leads, including all coaxial leads and connectors. Mishandling will cause deformation of sidewalls, and will degrade performance.

1.3.5 Environment

This product is for indoor or outdoor use, in dry locations, only. The product's external mains power supply (if required) is for indoor use only.



WARNING

To prevent injury or death, do not use in wet or damp conditions, or near explosive gas or vapor.



CAUTION

To prevent damage, always use and store your pulse generator in appropriate environments.

| | Storage | Operating |
|-------------------------|----------------------------------|--|
| Temperature | -20 °C to +50 °C | +5 °C to +35 °C (+15 °C to +25 °C or TCAL ± 5 °C for quoted accuracy) |
| Humidity | Up to 95 %RH (non-condensing) | Up to 85 %RH at +35 °C (non-condensing) |
| Altitude | 2000 m | |
| Pollution degree | 2 | |

1.3.6 Care of the product

The product and accessories contain no user-serviceable parts. Repair, servicing and calibration require specialized test equipment and must only be performed by Pico Technology or an approved service provider. There may be a charge for these services unless covered by the Pico five-year warranty.



WARNING

To prevent injury or death, do not use the product if it appears to be damaged in any way, and stop use immediately if you are concerned by any abnormal behavior.



CAUTION

To prevent damage to the device or connected equipment, do not tamper with or disassemble the instrument, case parts, connectors, or accessories.

When cleaning the product, use a soft cloth and a solution of mild soap or detergent in water, and do not allow liquids to enter the instrument's casing.

1.4 Software licence conditions

The material contained in this release is licensed, not sold. Pico Technology grants a licence to the person who installs this software, subject to the conditions listed below.

Access. The licensee agrees to allow access to this software only to persons who have been informed of these conditions and agree to abide by them.

Usage. The software in this release is for use only with Pico products or with data collected using Pico products.

Copyright. Pico Technology claims the copyright of, and retains the rights to, all material (software, documents etc.) contained in this release. You may copy and distribute the entire release in its original state, but must not copy individual items within the release other than for backup purposes.

Liability. Pico Technology and its agents shall not be liable for any loss, damage or injury, howsoever caused, related to the use of Pico Technology equipment or software, unless excluded by statute.

Fitness for purpose. As no two applications are the same, Pico Technology cannot guarantee that its equipment or software is suitable for a given application. It is your responsibility, therefore, to ensure that the product is suitable for your application.

Mission-critical applications. This software is intended for use on a computer that may be running other software products. For this reason, one of the conditions of the licence is that it excludes use in mission-critical applications, for example life support systems.

Viruses. This software was continuously monitored for viruses during production, but you are responsible for virus-checking the software once it is installed.

Support. If you are dissatisfied with the performance of this software, please contact our technical support staff, who will try to fix the problem within a reasonable time. If you are still dissatisfied, please return the product and software to your supplier within 14 days of purchase for a full refund.

Upgrades. We provide upgrades, free of charge, from our web site at www.picotech.com. We reserve the right to charge for updates or replacements sent out on physical media.

1.5 Trademarks

Windows is a registered trademark or trademark of Microsoft Corporation, registered in the U.S. and other countries.

Pico Technology Limited, PicoScope and **PicoSource** are trademarks of Pico Technology Limited, registered in the United Kingdom and other countries.

PicoScope and **Pico Technology** are registered in the U.S. Patent and Trademark Office.

1.6 Warranty

Pico Technology **warrants** upon delivery, and for a period of 2 years unless otherwise stated from the date of delivery, that the Goods will be free from defects in material and workmanship.

Pico Technology shall not be liable for a breach of the warranty if the defect has been caused by fair wear and tear, willful damage, negligence, abnormal working conditions or failure to follow Pico Technology's spoken or written advice on the storage, installation, commissioning, use or maintenance of the Goods or (if no advice has been given) good trade practice; or if the Customer alters or repairs such Goods without the written consent of Pico Technology.

2 Product information

2.1 What do I get?

PicoSource Pulse Generator kits contain the following items:

- PicoSource PG900 Series Pulse Generator
- PicoSource PG900 software disk
- Quick start guide
- AC adaptor 5 V DC at 2 A, universal input
- USB 2.0 cable, 1.8 m
- SMA/PC3.5/2.92 wrench
- Storage and carry case

Each signal generator is supplied with additional accessories, as shown below.

| Accessories | Order number | PicoSource model | | |
|---|--------------|------------------|-------|-------|
| | | PG911 | PG912 | PG914 |
| Positive 9040 40 ps TD pulse head | – | | ✓ | ✓ |
| Negative 9041 40 ps TD pulse head | – | | ✓ | ✓ |
| 12 GHz N(f) to SMA(m) adaptor (2) (fitted to TD pulse heads) | TA172 | | ✓ | ✓ |
| 10 GHz 20 dB SMA(m-f) attenuator (2) (fitted to SRD pulse outputs) | TA173 | ✓ | | ✓ |
| 50 Ω coaxial SMA(m-m) pulse drive cable, 60 cm (2) | – | | ✓ | ✓ |

2.2 Connections

Standard connectors

The PicoSource Pulse Generators have SMA connectors, compatible with both 2.92 mm (K) and PC3.5. The tunnel diode pulse heads have an N connector with a pre-installed N(f) to SMA(m) adaptor.

Connector diagrams



The PicoSource PG911 front panel from left to right:

- Positive integrated pulse output (SRD)
- Negative integrated pulse output (SRD)
- Trigger output. Connect to an external unit. This connector sends a single-ended voltage pulse.
- Trigger input. Connect an external signal for external triggering.

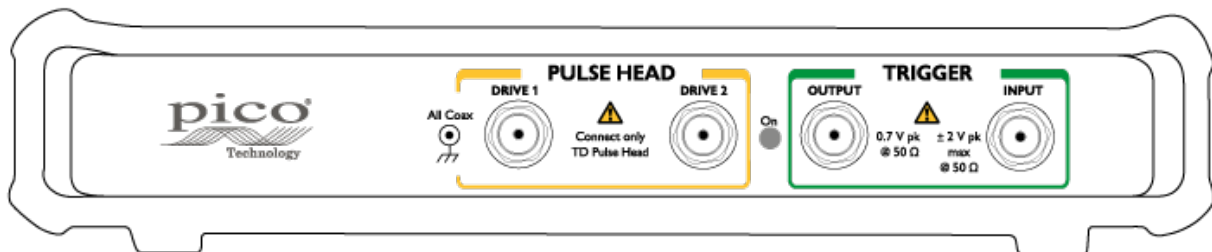

The PicoSource PG912 front panel from left to right:

- Drive 1 output connected to tunnel diode pulse head
- Drive 2 output connected to tunnel diode pulse head
- Trigger output. Connect to an external unit. This connector sends a single-ended voltage pulse.
- Trigger input. Connect an external signal for external triggering.

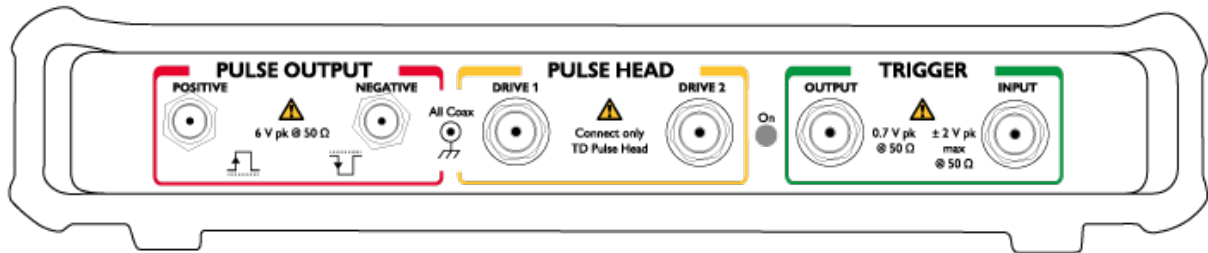

The PicoSource PG914 front panel from left to right:

- Positive integrated pulse output (SRD)
- Negative integrated pulse output (SRD)
- Drive 1 output connected to tunnel diode pulse head
- Drive 2 output connected to tunnel diode pulse head
- Trigger output. Connect to an external unit. This connector sends a single-ended voltage pulse.
- Trigger input. Connect an external signal for external triggering.

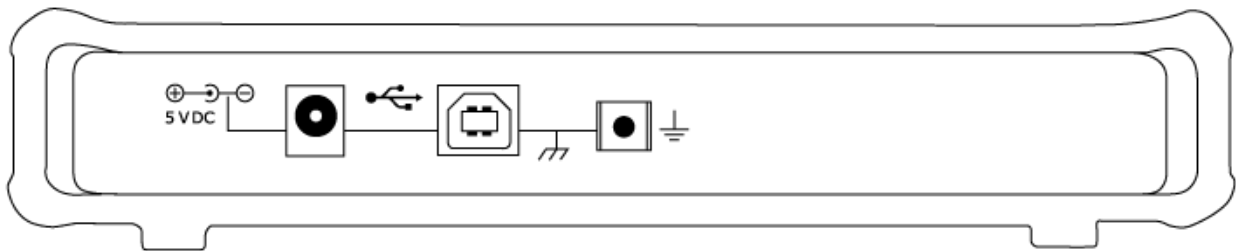

The PicoSource rear panel for all models from left to right:

- DC power input. Always use with the AC adaptor supplied with the unit
- USB 2.0 port. Use a USB cable to connect the pulse generator to your computer.
- Ground (chassis) terminal

3 How to use your pulse generator

3.1 Connection diagrams

To set up your PicoSource pulse generator, follow the instructions below.

1. Install the PicoSource PG900 software using the software disk supplied, or download it from picotech.com/downloads.
2. Plug the AC adaptor into the mains and connect the DC cable to the DC power socket on the rear of your PicoSource pulse generator.
3. **Earth (ground) terminal.** Some laptop power supplies can produce electrical noise which may interfere with your measurements. If this occurs, the earth terminal can be connected to an external ground point (for example, on the system you are testing) to provide a ground reference for the signal generator. This can help to avoid external noise interfering with your signal integrity. Alternatively, you can run the laptop using battery power.
4. Connect your PicoSource pulse generator to the PC or hub using the USB cable supplied.
5. Once you have connected the pulse generator to the PC, run the PicoSource PG900 software.

The following diagrams illustrate advanced setup options using a PicoSource pulse generator, a PicoScope oscilloscope, and the device under test (DUT). In all setups, the pulse generator shown can be substituted by the PicoSource PG914. Signal connections should be made using precision SMA cables unless otherwise specified. Trigger connections can be made using lower grade cables.

Diagram key

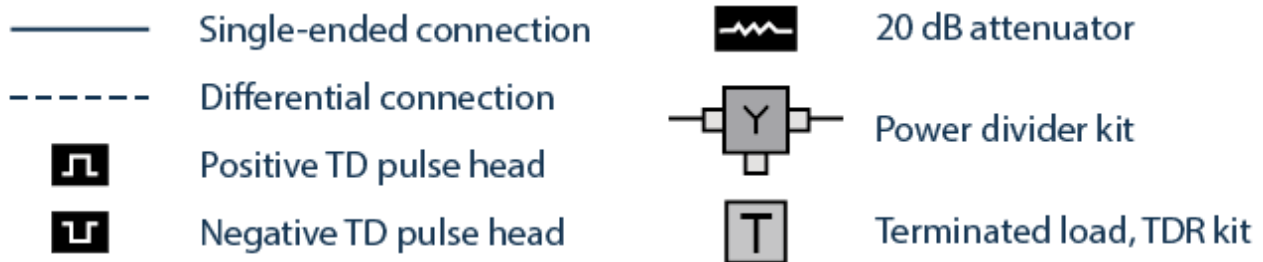

3.1.1 TDR applications

PicoSource PG900 pulse generators can be used to realize time domain reflectometry (TDR) with a PicoScope 9300 Series sampling oscilloscope that does not have that function (PicoScope 9301, 9302, 9321 and 9341).

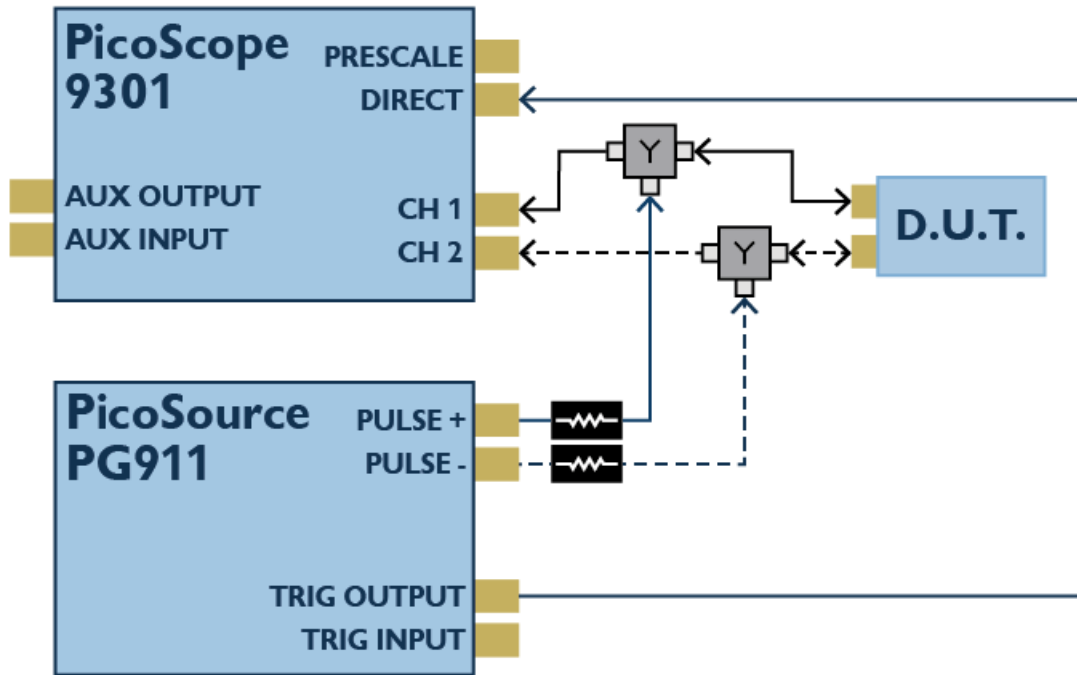

Single-ended and differential connections for TDR testing, using a PicoSource pulse generator with SRD outputs

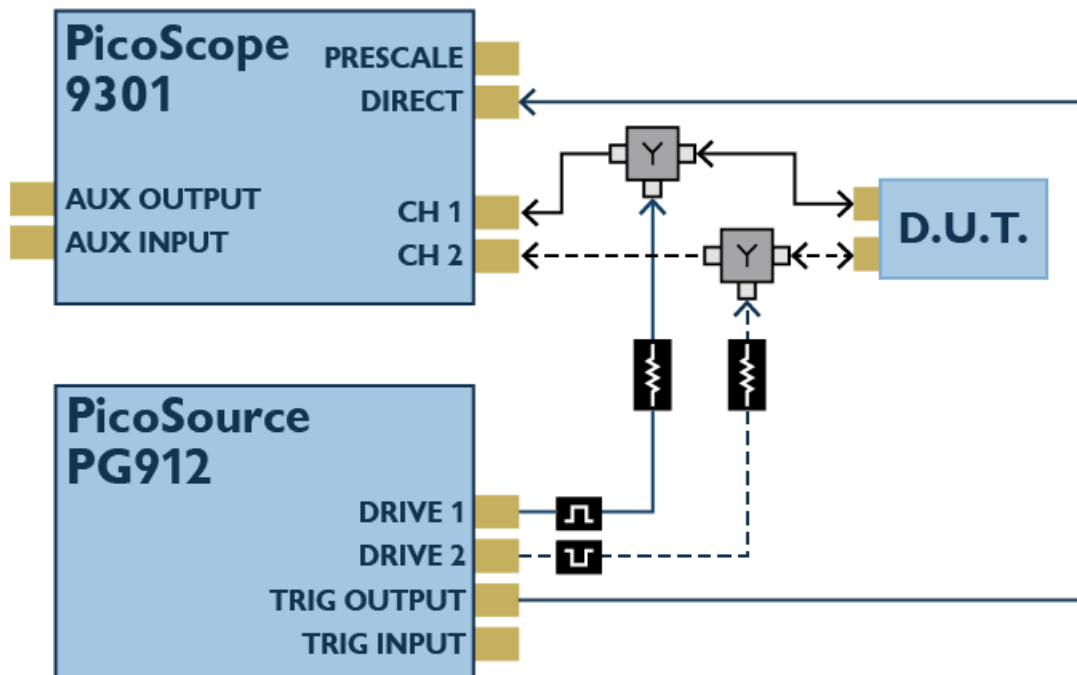

Single-ended and differential connections for TDR testing, using a PicoSource pulse generator with TD pulse head outputs

Connections between the pulse generator and the TD pulse heads (PicoSource PG912 and PG914 models only) should be made using the 60 cm coaxial SMA(m-m) cable supplied.

3.1.2 TDT applications

PicoSource PG900 pulse generators can be used to realize time domain transmission (TDT) with a PicoScope 9300 sampling oscilloscope without that function (PicoScope 9301, 9302, 9321, and 9341). They also offer the versatility of a remotely-placed signal generator for long line or installed system testing when used with any of the PicoScope 9300 models.

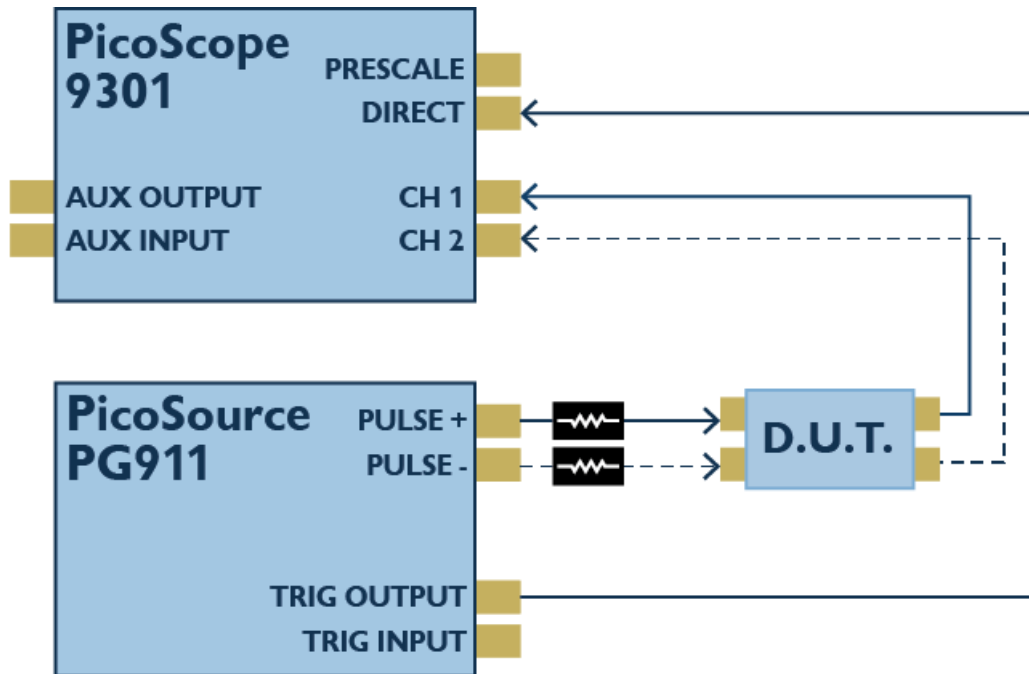

Single-ended and differential connections for TDT testing, using a PicoSource pulse generator with SRD outputs

3.1.3 TDT and crosstalk

PicoSource PG900 pulse generators can be used with a PicoScope 9341 four-channel sampling oscilloscope for simultaneous time domain transmission (TDT) and crosstalk assessment.

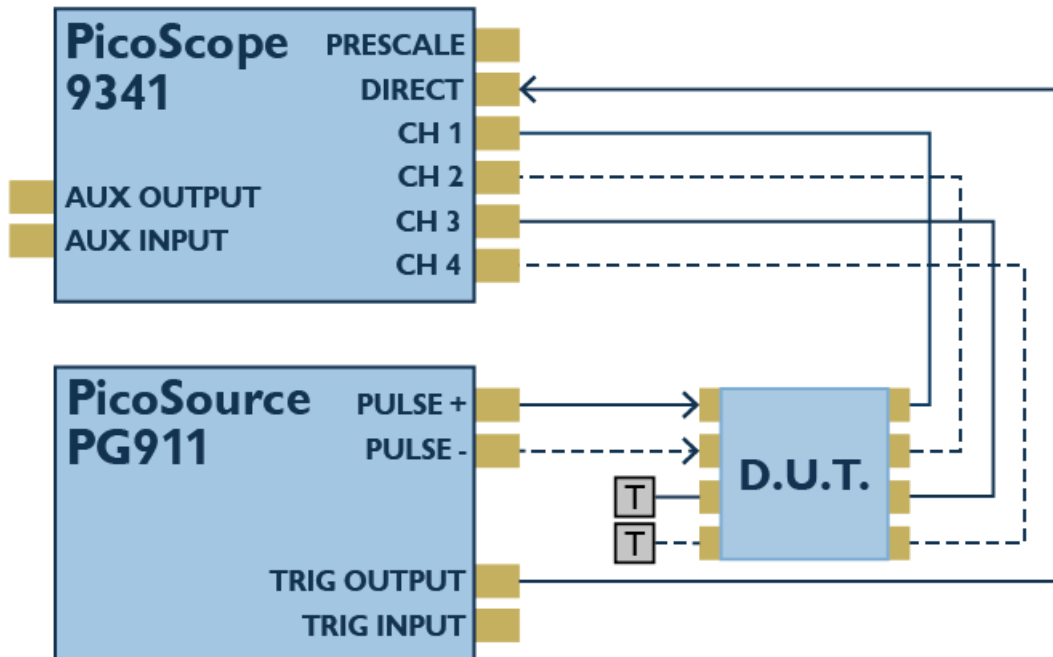

Single-ended and differential connections for simultaneous TDT and crosstalk assessment, using a PicoSource pulse generator with SRD outputs

3.2 Free-running operation for SRD integrated pulse outputs

Integrated pulse outputs based on SRD technology are available with the PicoSource PG911 and PG914 pulse generators. Follow the setup instructions below using the PicoSource PG900 software.

1. To switch on the positive SRD generator, click **Positive Out** in the **Output** menu, and then click **On**.

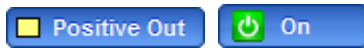

2. Make sure that **Period Source** is set to **Int Clock**.

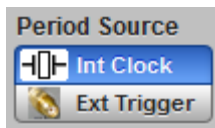

3. Make sure the **Trigger** is set to **Continuous**.

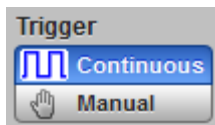

4. Set the **Period** in the **Timing** menu to provide the operation rate. Set the desired period value from 1 μ s to 1 s (1 MHz to 1 Hz).

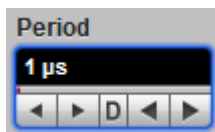

5. Set the **Width** in the **Timing** menu. Set the desired value from 200 ns to 4 s.

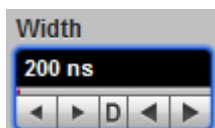

6. Set the desired **Limit** of output amplitude, from 2.5 V to 6 V, to protect the device under test. The change needs to be confirmed whenever the limit is increased.

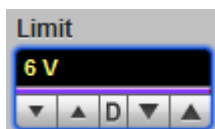

7. Set the desired output **Amplitude** from 2.5 V to 6 V.

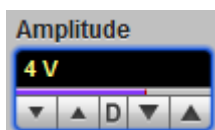

8. Under **Pulse Performance**, select **Smooth** or **Fast**. **Smooth** provides 60 ps rise time with smoother transient response. **Fast** provides faster rise time with higher overshoot.

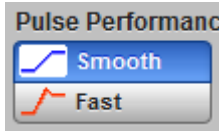

9. To switch on the negative SRD generator click **Negative Out** in the **Output** menu, and then click **On**.

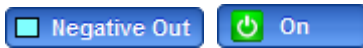

10. Repeat steps 6 to 8 for the negative output.
11. Set the **Deskew**. Set the desired value of delay between outputs within a 2 ns timing range.

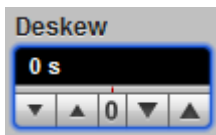

12. Under **Pos Out vs. Neg Out**, select **Separate** or **Paired**. With **Separate**, **Limit** and **Amplitude** controls change separately for positive and negative outputs. With **Paired**, both **Limit** and **Amplitude** controls change together for positive and negative outputs.



3.3 Free-running operation for TD outputs

TD outputs are available with the PicoSource PG912 and PG914 pulse generators with connected TD pulse heads (see [Connection Diagrams](#)).

1. To switch on the positive TD generator click **TD Head1 Out** in the **Output** menu, and then click **On**. The generator will automatically identify the polarity of the TD head connected to the **DRIVE 1** output.



2. Make sure that the **Period Source** is set to **Int Clock**.

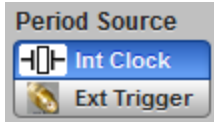

3. Make sure that the **Trigger** is set to **Continuous**.

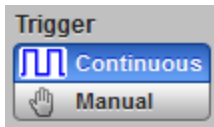

4. Set the **Period** in the **Timing** menu to provide the operation rate. Set the desired period value from 1 μ s to 1 s (1 MHz to 1 Hz).

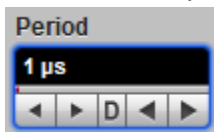

5. Set the **Width** in the **Timing** menu. Set the desired width value from 200 ns to 4 s. If necessary, set the **TD Current** to **Manual**.



6. Use the **Sensitivity** control to optimize the current value through the tunnel diode to get the optimal trigger point.

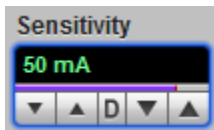

7. To switch on the negative TD generator click **TD Head2 Out** in the **Output** menu, and then click **On**.

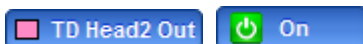

8. Repeat step 4 for negative TD output.

9. Under **Deskew**, set the desired delay value which can be set up to 500 ps for each channel.



3.4 External trigger operation

To operate the external trigger follow the setup instructions below.

1. For external trigger operation connect external trigger source to the **TRIGGER INPUT** connector.



2. Select the **Ext Trigger** from **Period Source**. The **External Trigger** menu will then open:

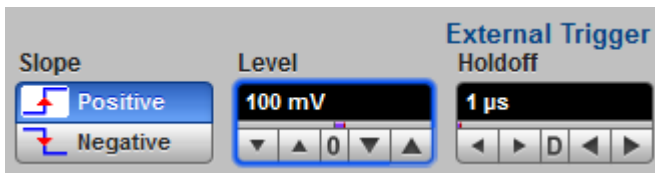
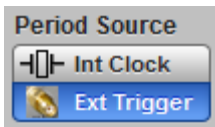

3. Under **Slope**, select **Positive** or **Negative** trigger slope.

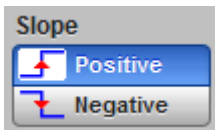

4. Adjust the **Level** control from -1 V to 1 V as necessary for stable operation.

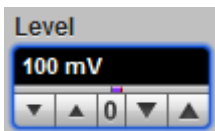

5. Set necessary **Holdoff** control from 1 μs to 1 s. Trigger holdoff helps to stabilize triggering of the generator. When you adjust the **Holdoff** control, the amount of time that the generator waits before re-arming the trigger circuitry also changes. This allows you to provide stable trigger up to 1 GHz.

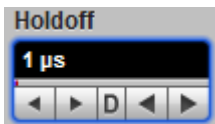

3.5 Single trigger operation

If **Int Clock** is selected under **Period Source**:

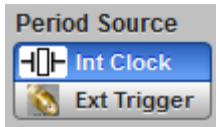

1. In the **Trigger** menu, click **Manual**.

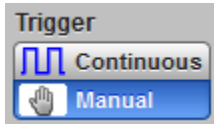

2. Click **Single**. Each click of this button causes a single pulse on each of the pulse generator's active outputs.

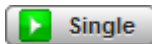

If **Ext Trigger** is selected under **Period Source**:

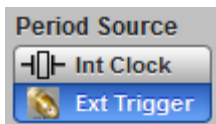

1. Connect an external trigger source to the **TRIGGER INPUT** connector.



2. In the **Trigger** menu, click **Manual**.

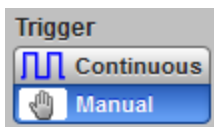

3. Click **Ready**. Now the generator is armed to respond to any defined trigger signal. Each click of this button causes a new arming state of the pulse generator.

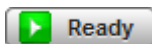

4 PicoSource PG900 software

The PicoSource PG900 software interface provides easy access to controls for all of the pulse generator's features and functions.



Areas of the software interface

4.1 Display area

The following zones are features of the **Display Area**:

- Trigger Output Waveform
- Positive Output Waveform
- Negative Output Waveform
- TD Head1 Output Waveform
- TD Head2 Output Waveform
- Vertical Scale for Trigger Output
- Vertical Scale for Positive and Negative Outputs
- Vertical Scale for TD Head Outputs
- Horizontal Scale
- Intensified Zone

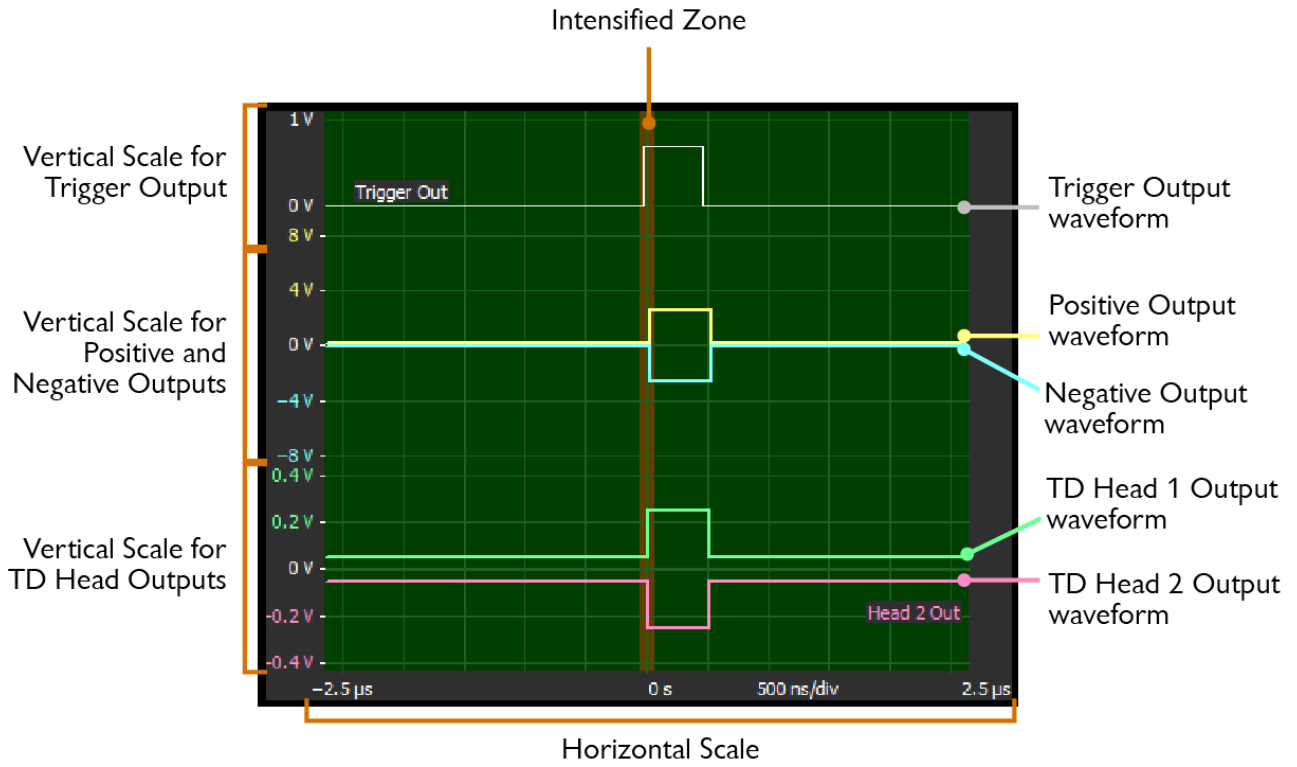

4.1.1 Intensified Zone

The Intensified Zone shows a horizontal section of the display area that can be expanded using the **Horizontal Scale** control (see below).

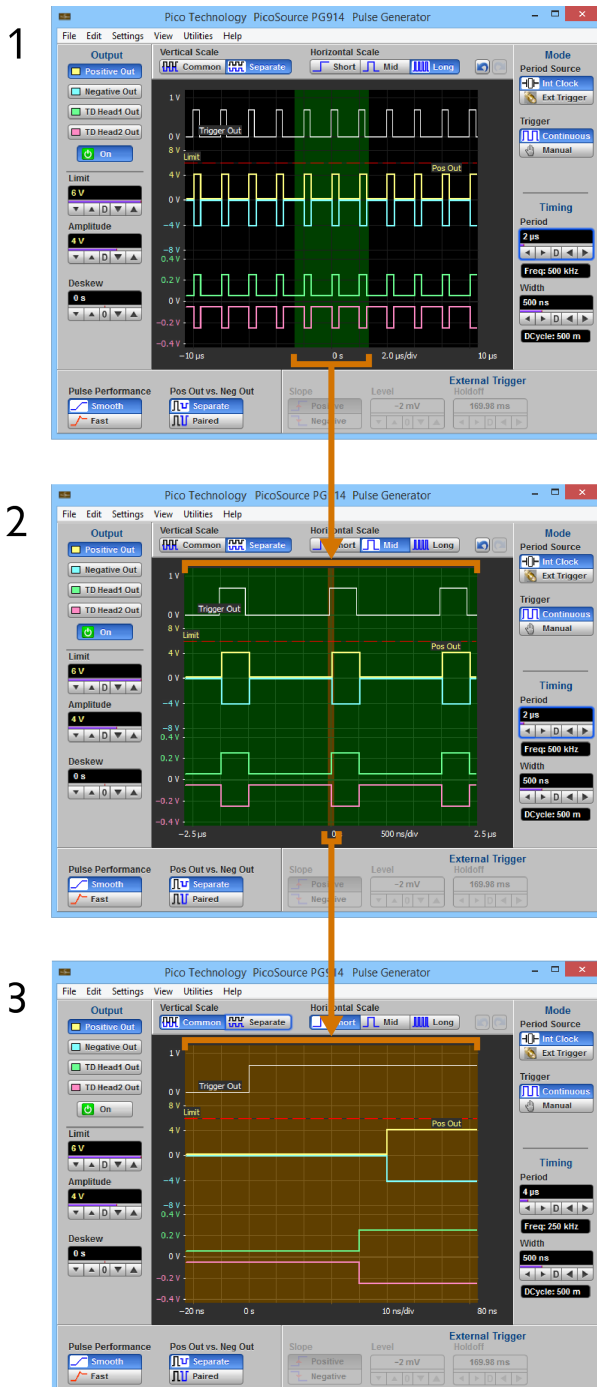

1. All waveforms are shown on a 2 $\mu\text{s}/\text{div}$ Long Horizontal Scale. The Intensified zone section has a 5 μs duration.
2. All waveforms are shown on a 50 ns/div Middle Horizontal Scale, expanded from the Long Horizontal Scale. Intensified zone now has a 100 ns duration.
3. All waveforms are shown on a 10 ns/div Short Horizontal Scale (expanded Middle Horizontal Scale).

4.2 Positive and negative pulse outputs

Positive Output and Negative Output



These controls select menus based on SRD technologies for the PicoSource PG911 and PG914. Each menu includes the options outlined below.

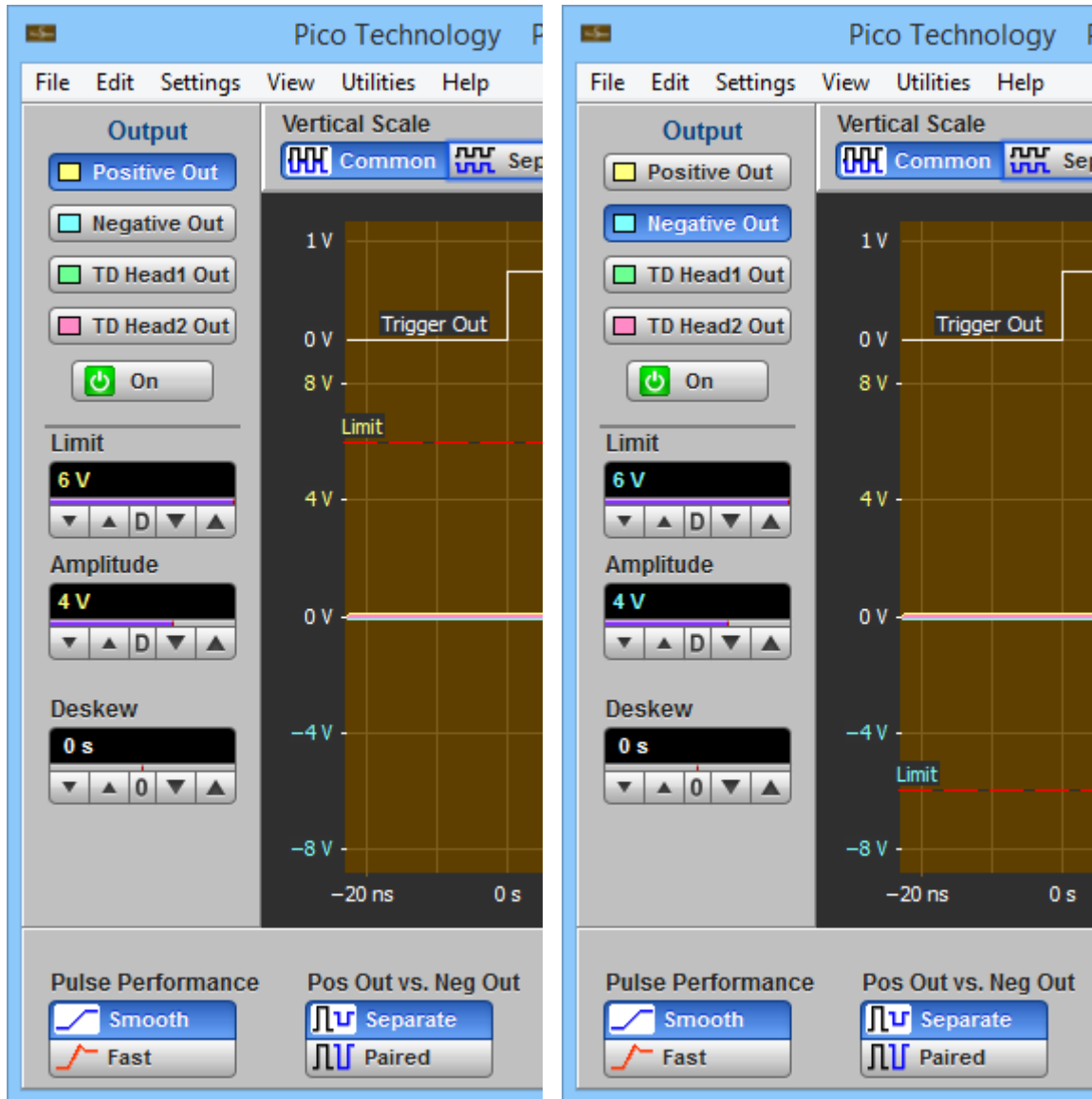

Positive Output (left) and Negative Output (right) menus



On

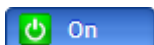

Click **On** to turn the selected output on or off.

Amplitude

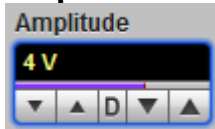

Amplitude is the low-to-high magnitude of the pulse. The **Amplitude** setting can be set from 2.5 V to 6 V, adjustable in 100 mV coarse increments or in 10 mV fine increments. Changing the amplitude will change the high level only. Low level is always set at 0 V. Offset is not affected.

Limit

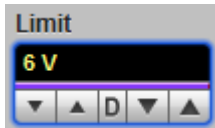

To protect the device under test, amplitude limits can be set for both the **Positive Output** and **Negative Output**. Output amplitude can be limited to a user defined value from 2.5 V to 6 V, Adjustable in 100 mV coarse increments or in 10 mV fine increments.

Deskew



Set the deskew between **Positive Output** and **Negative Output** to compensate for different cable delays. Set the **Deskew** between output in the range of -1.00 ns to 1.00 ns. Adjustable in a 20 ps coarse increment or in 1 ps fine increment.

Pulse Performance

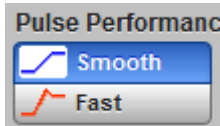

The transition response can be modified by the **Pulse Performance** selector:

- **Fast** - provides faster transient times (55 ps or less) with near 40% overshoot.
- **Smooth** - provides slower transient times (60 ps or less) and smoother edges less than 20%.

Pos Out vs. Neg Out



Positive Output and **Negative Output** operate as entirely separate outputs. Their **Amplitude** and **Limit** variables can be controlled separately.

- **Separate** - **Positive Output** and **Negative Output** operate as entirely separate outputs. Their **Amplitude** and **Limit** variables can be controlled separately.
- **Paired** - **Positive Output** and **Negative Output** operate together. Their **Amplitude** and **Limit** variables are controlled simultaneously.

4.3 Tunnel diode pulse head outputs



TD Head 1 Output (left) and TD 2 Head Output (right) menus

The **TD Head 1 Output** and **TD Head 2 Output** menus control the outputs of two TD heads. These heads may be connected to the **DRIVE 1** or **DRIVE 2** SMA connectors located on the front panel of the PicoSource PG912 and PG914. Each drive output provides the head the necessary TD current and drive signal.

Each drive output senses the polarity of the TD head connected to the drive output. Thereby it is possible to connect as positive or as negative TD head to any **DRIVE** output. The drive output will provide a positive current and positive drive output for the positive TD head, or a negative current and negative drive output for the negative TD head, depending on which is detected. The recognized polarity of the TD head appears in the menu area under **Pos TD Head** or **Neg TD Head**.

Pos TD Head **Neg TD Head**

Pulse generators based on TD technology may include the following configurations:

- Single-channel pulse generator with TD pulse head having any polarity.
- Dual-channel pulse generator with two TD pulse heads having opposite polarity.
- Dual-channel pulse generator with two TD pulse heads having the same polarity. In this case you should request an additional TD head.

On



You can switch on and off any of the **DRIVE Outputs** with connected TD head.



TD Current

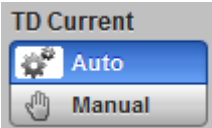

The **TD Current** controls how the instrument defines peak current of TD for selected TD head.

- **Auto** - the instrument defines peak current automatically.
- **Manual** - the instrument controls peak current manually with the **Sensitivity** control. Use this mode for very fine tuning of TD.

Sensitivity

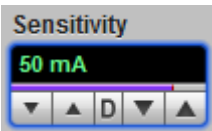

This controls peak current of TD manually when the **Manual** is selected from the **TD Current**.

Deskew



Set the deskew between **TD Head 1 Output** and **TD Head 2 Output** to compensate for different cable delays. Set the **Deskew** between output in the range of 0 ps to 500 ns. Adjustable in a 20 ps coarse increment or in 1 ps fine increment.

4.4 Tunnel diode pulse head controls

TD Current

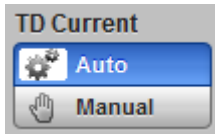

The **TD Current** controls how the instrument defines peak current of TD for selected TD head.

- **Auto** - the instrument defines peak current automatically.
- **Manual** - the instrument controls peak current manually with the **Sensitivity** control. Use this mode for very fine tuning of TD.

Sensitivity

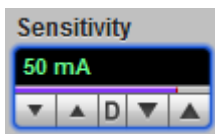

This controls peak current of TD manually when the **Manual** is selected from the **TD Current**.

Deskew



Set the deskew between **TD Head 1 Output** and **TD Head 2 Output** to compensate for different cable delays. Set the **Deskew** between output in the range of 0 ps to 500 ps. Adjustable in 20 ps coarse increments or in 1 ps fine increments.

4.5 Mode

The **Mode** group includes **Period Source** and **Trigger** selections.

Period Source

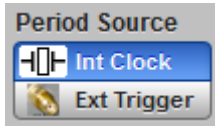

The **Period Source** defines which source will be used as the period clock. There are two sources, internal or external.

- **Int Clock**

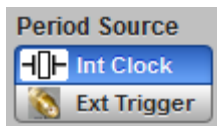

In the **Internal Clock** an internal continuous pulse stream is generated. The period can be set from between 1 μ s to 1 s (a frequency from 1 Hz to 1 MHz).

- **Ext Trigger**

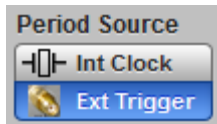

In the **External Trigger** each active input edge on the **TRIGGER INPUT** connector triggers a single or countdown output cycle.

Trigger

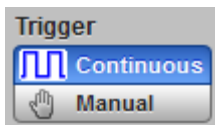

The **Trigger** defines how pulses are generated, continuously or manually.

- **Continuous** pulse periods are generated continuously by using internal or external clock source.
- The **Manual** option can be used to manually run (**Int Clock Period Source**) or arm (**Ext Trigger Period Source**) each pulse period.

Single

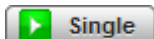

Click **Single** to generate one pulse period when the **Int Clock** is selected from the **Period Source**.

Ready

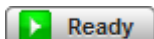

Click **Ready** to arm the instrument to generate one pulse period when the **Ext Trigger** is selected from the **Period Source**.

4.6 Timing

When the **Int Clock** is selected from the **Period Source** menu the **Timing** menu opens.

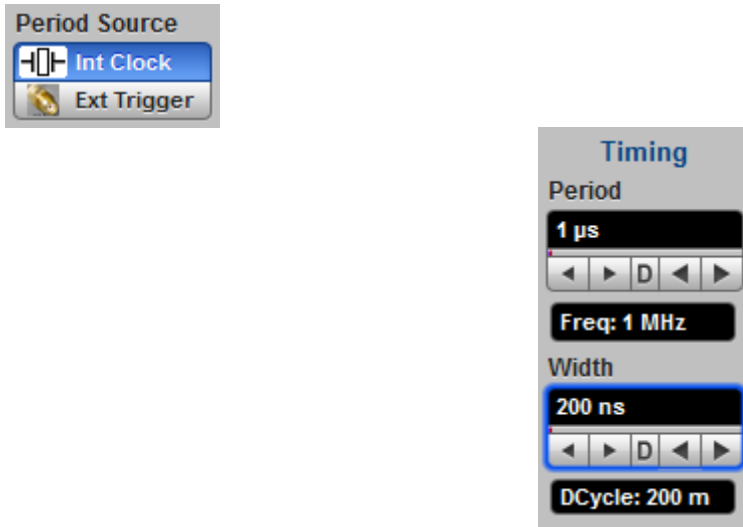

Timing Menu

Period



The pulse cycle time can be set as a period. The **Frequency** value, as $1/\text{Period}$, is shown under **Period**. The period value can be set from $1\ \mu\text{s}$ to $1\ \text{s}$, adjustable in 1-2-5-10 coarse increments or 200 ns fine increments.

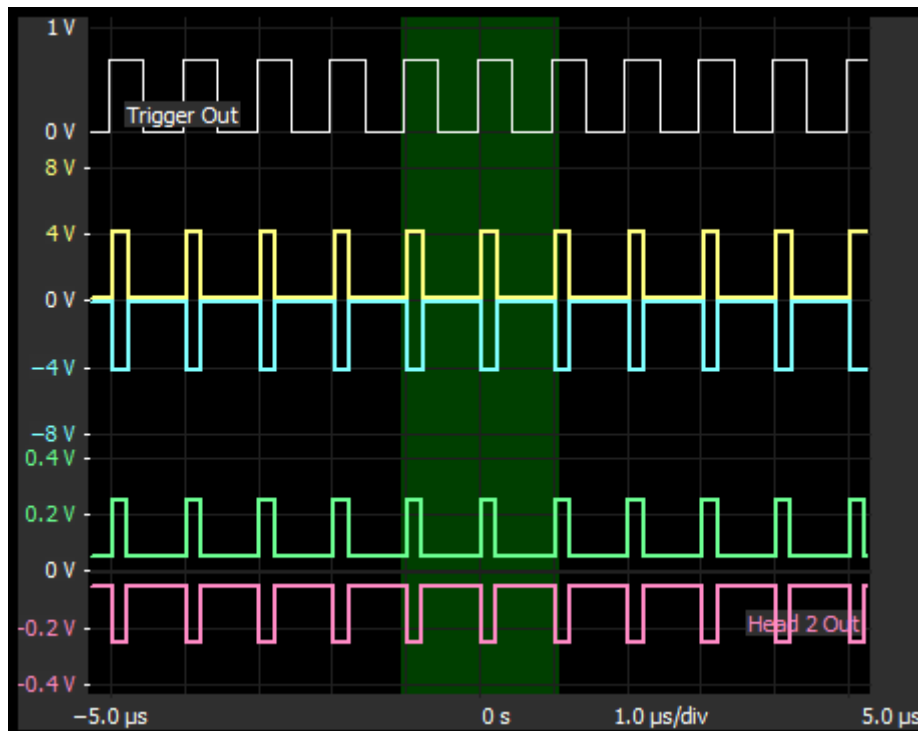

Guide User Interface showing timing relations

Width

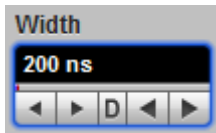

Width sets the absolute pulse width measured from the start of the leading edge to the start of the trailing edge. In this format, the pulse width is independent of changes in pulse period and delay. Pulse width is defined at the 50% amplitude level of the pulse.

The duty cycle is the pulse width measured from the start of the leading edge to the start of the trailing edge expressed as a percentage of the period. **Duty Cycle** value in percents as Width/Period is shown under **Width** control. Width value can be set from 200 ns to 4 μ s, adjustable in 200 ns - 500 ns - 1 μ s - 2 μ s - 4 μ s coarse increments or a 25 ns fine increment.

DCycle: 200 m

The following duty cycle limitations apply to **Positive Output** and **Negative Output** based on SRD technologies:

- From 2.5 V to 4 V amplitude: 50% max.
- From 4.1 V to 6 V amplitude: 20% max.

No duty cycle limitations apply to TD-based outputs.

Delay

The PicoSource pulse generators do not provide variable delay as the absolute delay from the trigger output to the start of the leading edge of the pulse can be ignored. The generators provide deskew between output channels for both SRD and TD technologies.

4.7 External trigger

External Trigger

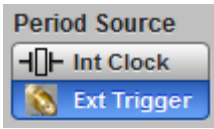

When **Ext Trigger** is selected from the **Period Source** menu, you can use an external trigger signal connected to the **TRIGGER INPUT** as an external trigger source (triggered or countdown).



When the period of the external trigger signal is longer than the selected holdoff time, the PicoSource pulse generator generates all outputs and trigger output as a single pulse on every trigger period (triggered).



Timing diagram for external triggered mode (2 μs period of external signal)

When the period of the external trigger signal is shorter than the selected holdoff time, the PicoSource pulse generator generates all outputs and trigger output as a single pulse every two or more trigger periods (countdown).

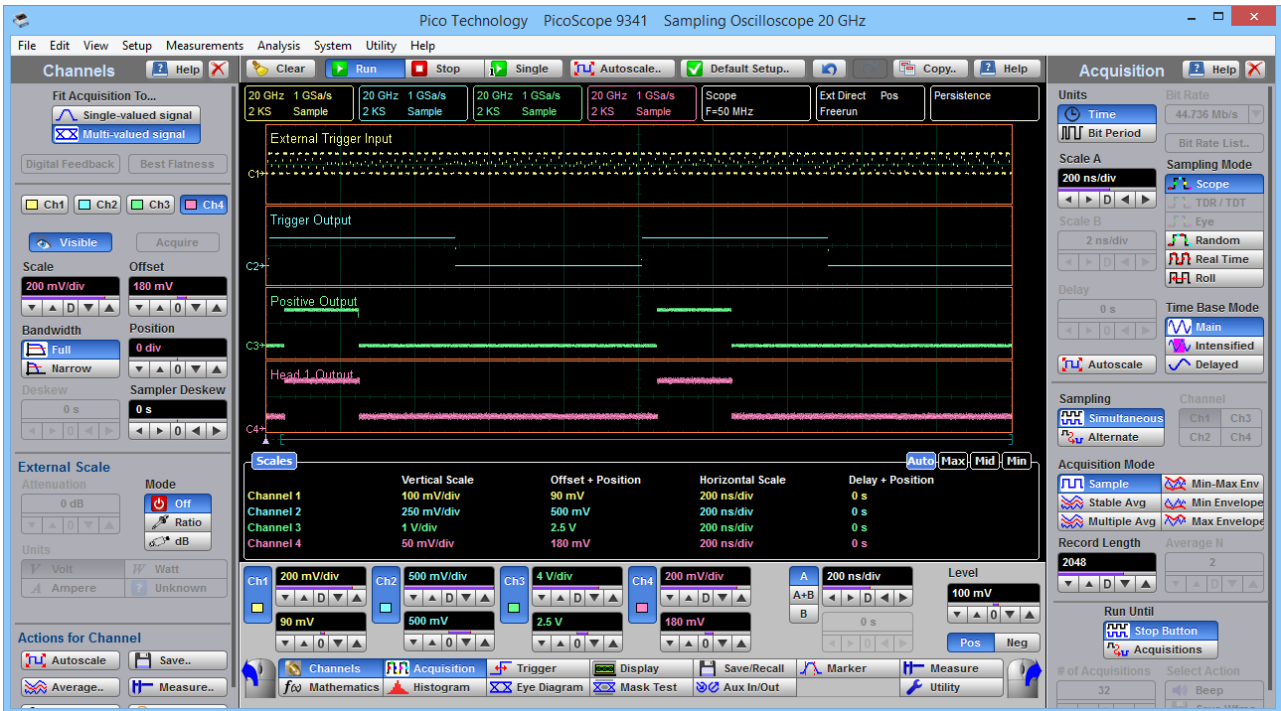

Timing diagram for external countdown mode

The image below shows timing relations between different signals. They are:

- Delay between external trigger input and trigger output: near 4 ns.
- Delay between trigger output and SRD outputs: near 40 ns.
- Delay between trigger output and TD Head output: near 42 ns.

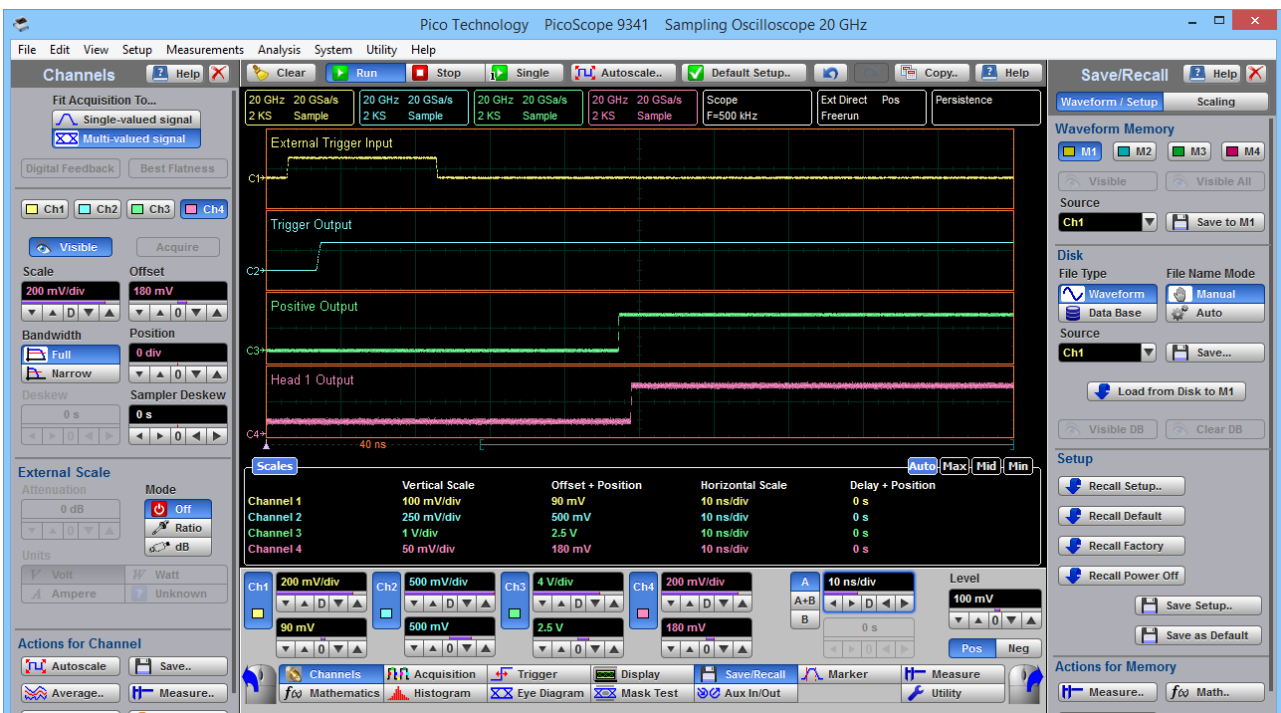

Timing relations between different signals

External Trigger Menu

When **Ext Trigger** is selected from the **Period Source** menu the **External Trigger** menu opens.

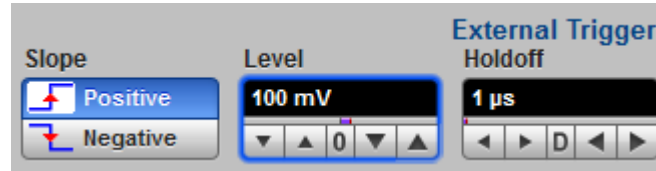

External Trigger Menu

The **External Trigger** menu controls three settings: **Slope**, **Level** and **Holdoff**.

Note: The input impedance on the **TRIGGER INPUT** connector is fixed at 50 Ω .

Slope

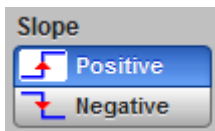

With the **Ext Trigger** period source selected, the positive edge or negative edge of the source will trigger a pulse period.

Level

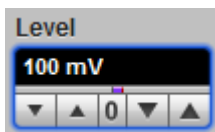

The **Level** sets the trigger level threshold in the range of -1 V to 1 V that will be detected by the pulse generator as a valid trigger input pulse. Adjustable in coarse increments of 10 mV or fine increments of 1 mV.

Holdoff

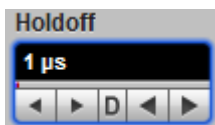

Holdoff is a count of a period of time. With external trigger it disables the trigger circuit after a given period of time, after the last trigger occurred. Use holdoff to obtain a stable trigger for HF repetitive, composite or complex waveforms.

Example 1. External trigger frequency is much higher than generating pulse frequency.

Example 2. If the number or duration of sub-signals is known you can disable them by choosing an appropriate holdoff value.

The **Holdoff** range is from 1 μ s to 1 s in a 1-2-5-10 sequence. When fine mode is on, you can change holdoff time in increments of up to 200 ns.

4.8 Trigger output



The output trigger signal on the **TRIGGER OUTPUT** connector marks the start of the pulse period. This positive pulse has a fixed amplitude of near 700 mV, a fixed pulse width of near 500 ns, and a rise time of less than 400 ps 10%-90%.

This pulse is delayed by approximately 4 ns from the external trigger input. It also has a lead time of near 40 ns to the SRD outputs, and near 42 ns to the TD Head output.

Use this signal to pretrigger your sampling oscilloscope.

4.9 Display scaling

Display scaling includes two menus: the **Vertical Scale** and the **Horizontal Scale**.

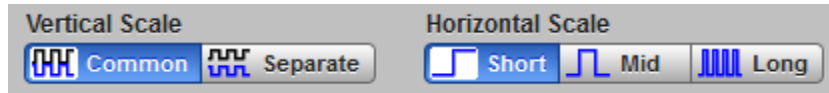

Display scaling menus

4.9.1 Vertical Scale

Vertical Scale



The **Vertical Scale** determines how all of the waveforms (up to four outputs and the trigger output) are displayed vertically by the PicoSource software.



With **Common** selected any displayed output waveforms are superimposed on top of each other, while the trigger output is displayed separately above the scale (as shown below).

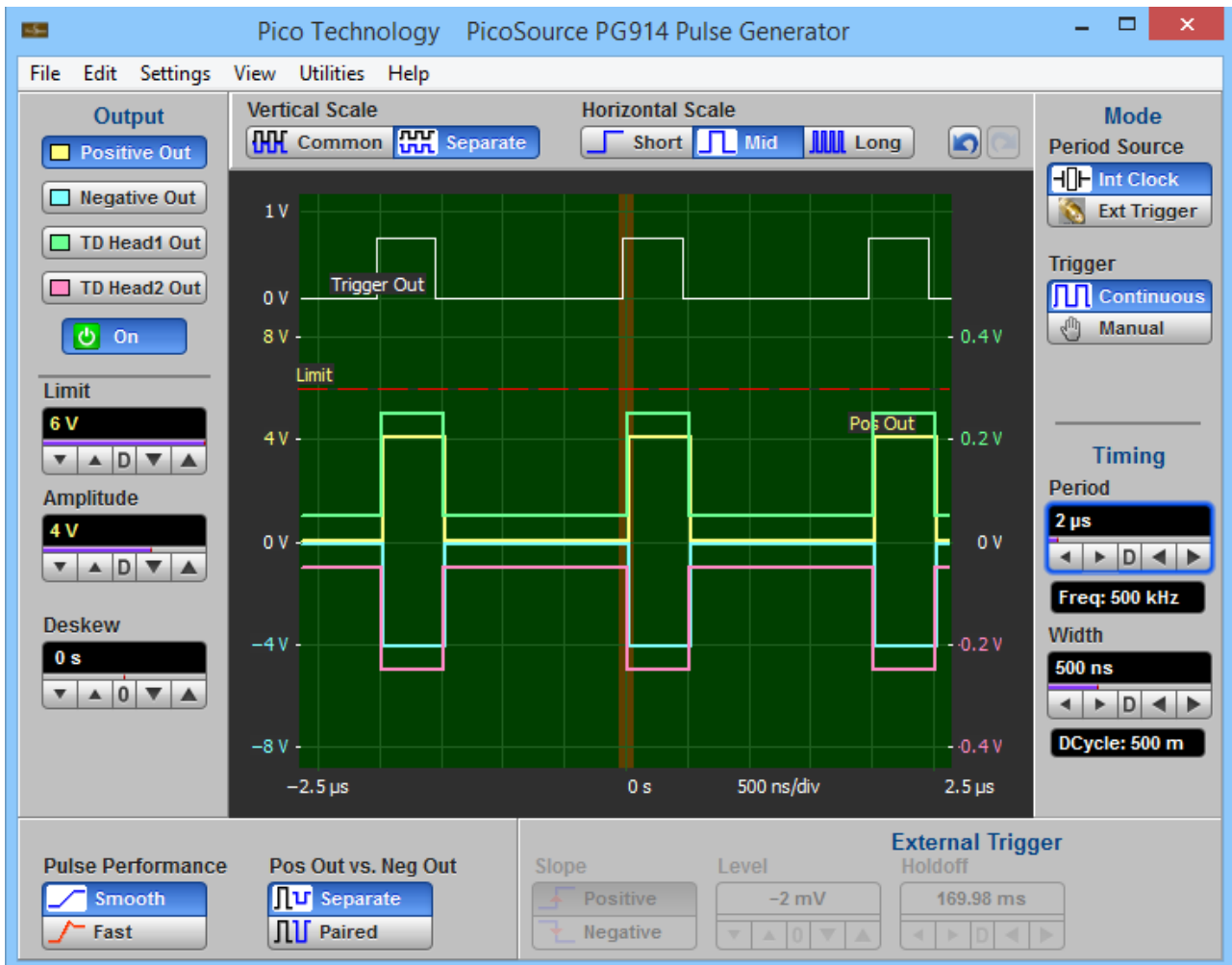

Common Vertical Scale display

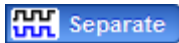

With **Separate** selected, the two output waveforms that belong to SRD technology, the two output waveforms that belong to TD technology, and the trigger output are all displayed separately on three vertical scales (as shown below).

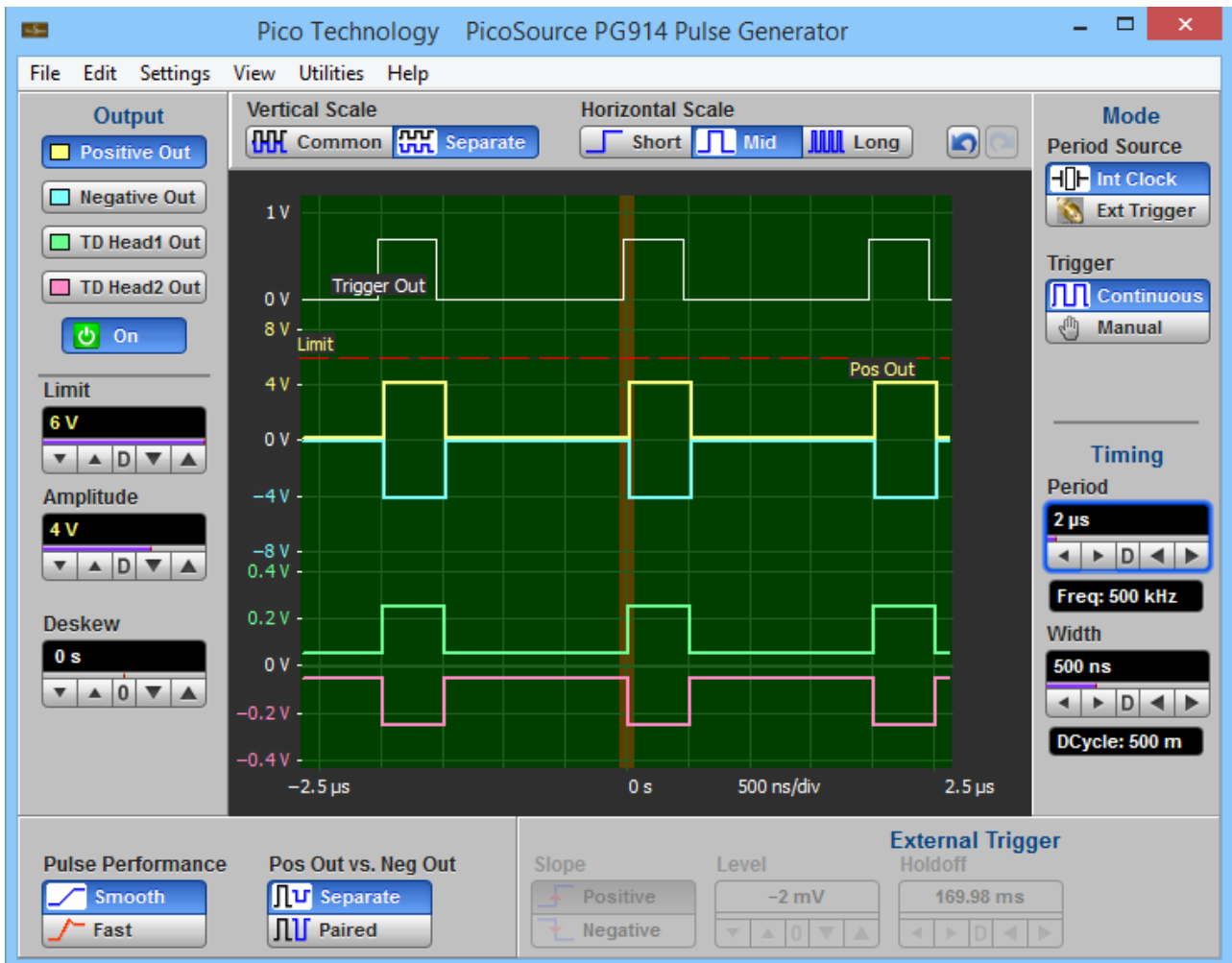

Separate Vertical Scale display

4.9.2 Horizontal Scale

Horizontal Scale

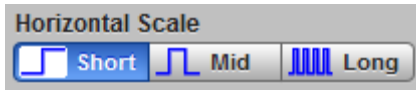

The **Horizontal Scale** menu includes three different options.

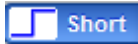

With **Short** selected the horizontal scale is optimized to show the timing relationships between pulse edges on all waveforms (as shown below).

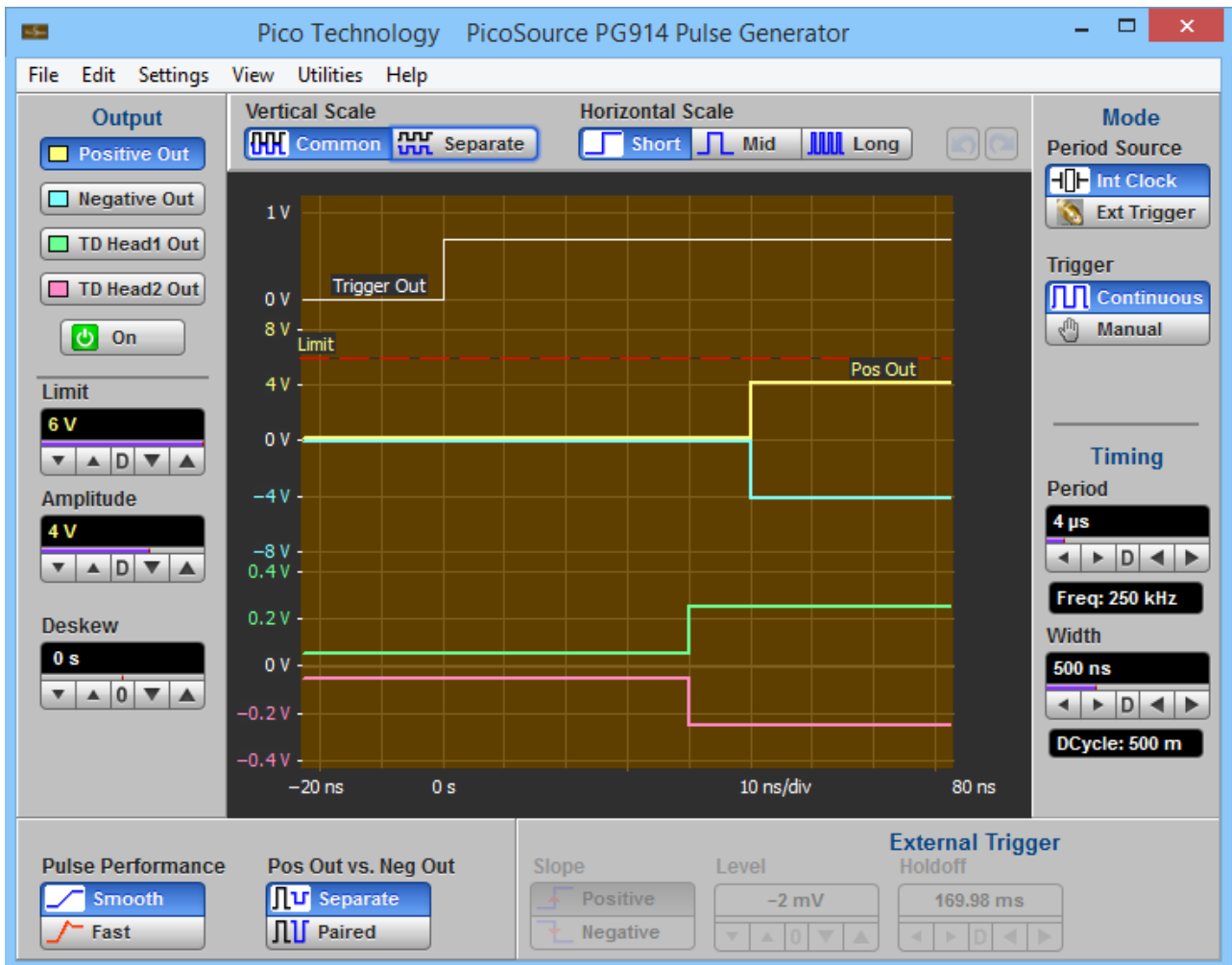

Short Horizontal Scale display



With **Middle** selected the horizontal scale is optimized to show the pulse width of all waveforms (as shown below).

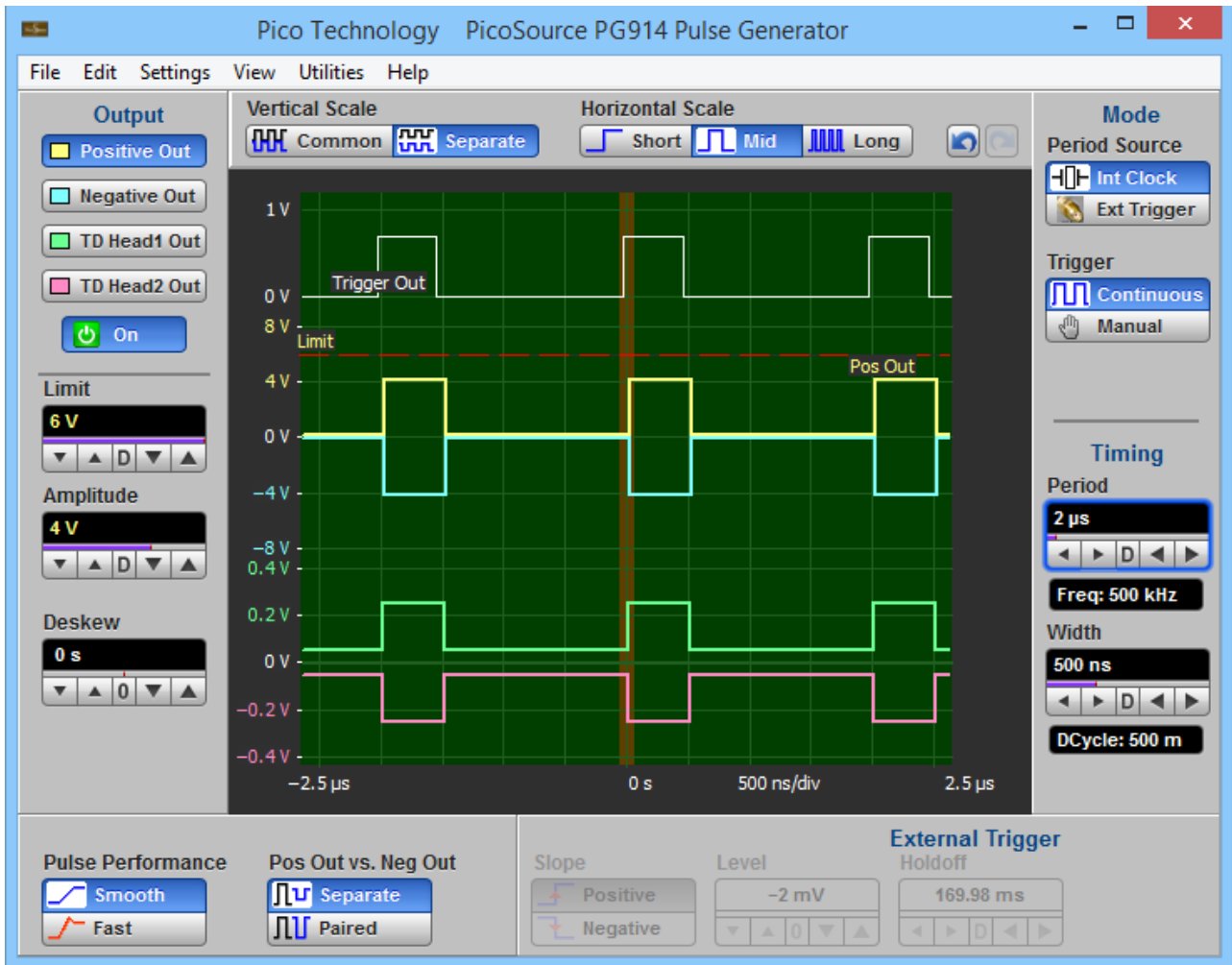

Middle Horizontal Scale display



With **Long** selected the horizontal scale is optimized to show the period of all waveforms (as shown below).

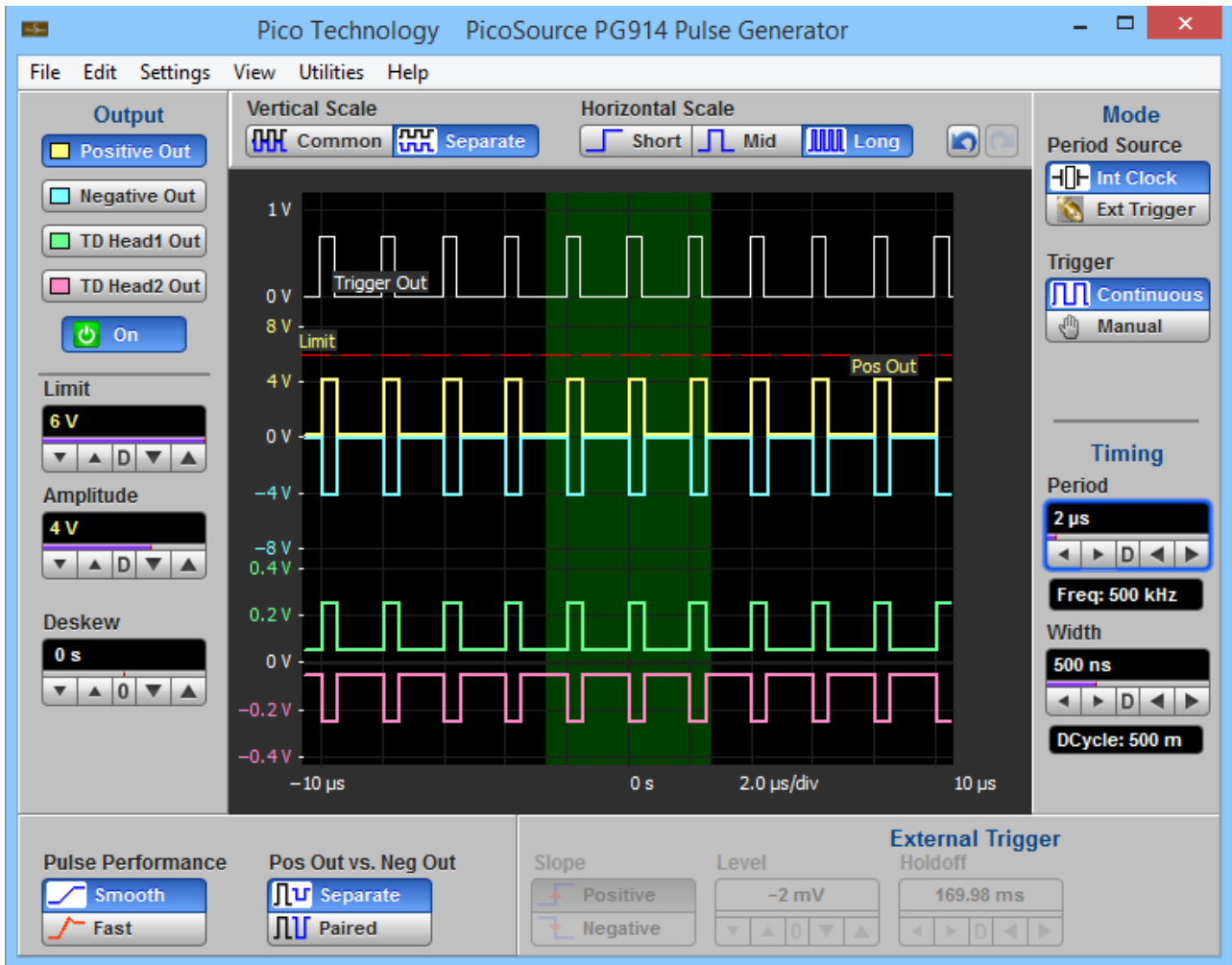

Long Horizontal Scale display

4.10 Undo/Redo

Undo and Redo



Undo

If you have unintentionally selected a control, you can use the **Undo** button to return the instrument to the previous settings. The **Undo** function can be repeated up to 100 times.



Redo

If you later decide you didn't want to undo an action, right-click the button and select **Redo**.

4.11 Main Menu



The **Main Menu** provides access to commands that control all of the instrument features and functions. When you select a feature setup command, the instrument displays the associated menus.

5 Theory of operation

5.1 PicoSource PG900 block diagram

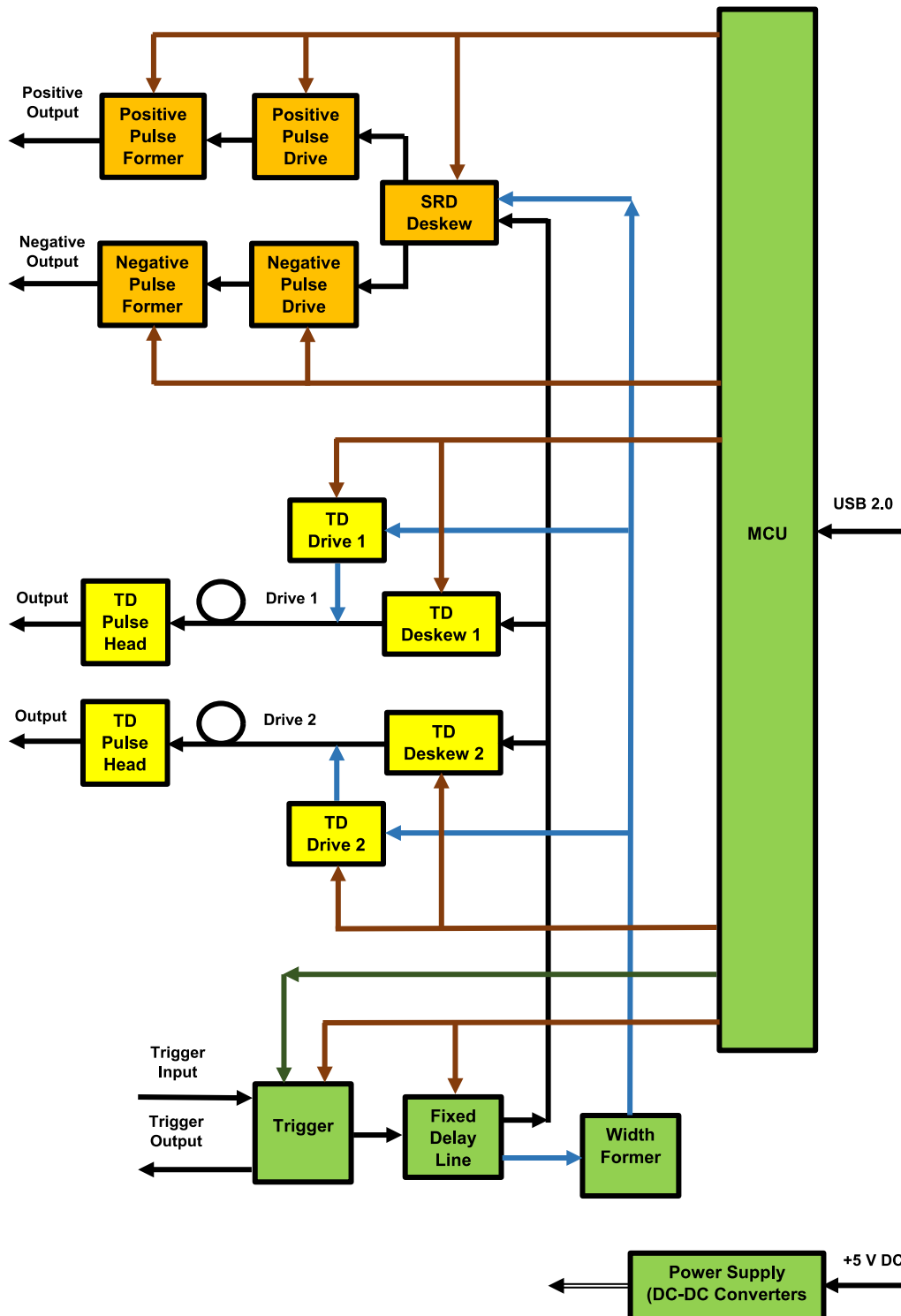

PicoSource PG900 hardware overall block diagram

Green: all models
 Gold: PicoSource PG911 and PG914 only
 Yellow: PicoSource PG912 and PG914 only

5.2 Hardware components for PicoSource PG900 models

ARM microcontroller

The ARM microcontroller controls all hardware components of the PicoSource PG900 generators.

USB transceiver

A standard slave USB controller for communication with PC.

Power supply

The power supply provides necessary stabilized DC power voltages from incoming +5 V DC from the power adaptor.

Trigger

The trigger generator provides internal or external trigger period from 1 μ s to 1 s.

Fixed delay line

Provides lead time between trigger output and any of four main outputs.

Width former

Triggerable one-shot providing pulse width control from 0.2 to 4 μ s.

SRD deskew

Provides 2 ns p-p differential timing deskew between integrated SRD outputs.

Positive pulse drive

Drives positive pulse former of integrated SRD generator. Controls output amplitude.

Negative pulse drive

Drives negative pulse former of integrated SRD generator. Controls output amplitude.

Positive pulse former

Provides positive SRD output with leading edge faster than 60 ps.

Negative pulse former

Provides negative SRD output with leading edge faster than 60 ps.

TD deskew 1

Provides at least 200 ps timing deskew for TD 1 pulse head.

TD deskew 2

Provides at least 200 ps timing deskew for TD 2 pulse head.

TD drive 1

Controls peak current and timing diagram of TD 1.

TD drive 2

Controls peak current and timing diagram of TD 2.

TD pulse heads

Two pulse heads with any selected polarity having leading edge faster than 40 ps.

6 Specifications and characteristics

The distinction between specifications, characteristics, typical performance, and nominal values is as follows.

Specifications describe guaranteed performance over the temperature range +15°C to +25°C (unless otherwise noted). All specifications apply after the instrument's temperature has been stabilized after 1 hour of continuous operation. Unless otherwise noted, corrected limits are given when specifications are achieved using software processing.

Many performance parameters are enhanced through frequent, simple calibrations.

All specifications are subject to change without notice. Specifications are valid after a 1 hour warm-up period, and $\pm 5^\circ\text{C}$ from the firmware calibration temperature.

Characteristics provide useful, but not guaranteed, information about the functions and performance of the instrument.

Typical Performance, where listed, is not guaranteed, but indicates the performance that most units will exhibit.

Nominal Value indicates the expected, but not guaranteed, value of the parameter.

Factory Calibration Cycle. For optimum performance, the instrument should have a complete verification of specifications once every 12 months.

6.1 PG900 family specifications

| Specifications | PicoSource PG911 | PicoSource PG912 | PicoSource PG914 |
|-----------------------------|---|---|---|
| Generation technique | Integrated step recovery diode pulse outputs | Drive outputs with tunnel diode pulse heads | Integrated step recovery diode pulse outputs and drive outputs with tunnel diode pulse heads |
| Output channels | 2 SRD | 2 TD | 2 SRD + 2 TD |
| Output waveform | Dual-channel positive and negative pulse generators with controlled amplitude and timing parameters | Dual-channel positive and negative pulse generators with fixed amplitude and controlled timing parameters | Four-channel positive and negative pulse generators with controlled amplitude and timing parameters |

6.2 Integrated step recovery diode outputs

| Specifications | PicoSource PG911 and PG914 |
|---|--|
| Waveform | Positive-going (fast rise) and negative-going (fast fall) outputs returning to 0 V. Adjustable amplitude and timing parameters. Fast transition on leading edge. |
| Polarity | Positive and negative |
| Amplitude | |
| Range | From 2.5 V to 6 V @ 50 Ω |
| Resolution | Adjustable in a 100 mV coarse increment, 10 mV fine increment |
| Accuracy | $\pm 10\%$ |
| Amplitude limit | Output amplitude can be limited to a user defined value from 2.5 V to 6 V to protect the device under test. Adjustable in a 100 mV coarse increment 10 mV fine increment. |
| Leading edge transition time, 10%–90% | Smooth pulse performance: 60 ps or less. |
| Overshoot | Positive or negative-going, fast pulse performance: 40% or less. |
| Pulse aberrations | Positive or negative-going, smooth pulse performance: +20%, –10% or less for the first 2 ns following leading step transition. $\pm 7\%$ or less over the zone 2 ns to 10 ns following leading step transition. $\pm 2\%$ or less over the zone 10 ns to (pulse width–50 ns). |
| Trailing edge transition time, 10%–90% | 8 ns or less |
| Duty cycle limit | 2.5 V to 4 V amplitude: 50% max. 4.01 V to 6 V amplitude: 20% max. |
| RMS jitter, trigger output-to-output | 3 ps typ, 3.5 ps max |
| Deskew between outputs | |
| Range | Differential: 2 ns p-p typ |
| Resolution | Adjustable in a 20 ps coarse increment 1 ps fine increment |
| Delay, trigger output-to-output | (48 \pm 2) ns, fixed |
| Output connector | SMA(f) |

6.3 Drive output with tunnel diode pulse heads

| Specifications | PicoSource PG912 and PG914 |
|---|--|
| Polarity | 9040 TD Pulse Head: Positive-going (fast rise) output. 9041 TD Pulse Head: Negative going (fast fall) output. Fast transition on leading edge. |
| Amplitude | (200 ± 50) mV @ 50 Ω, fixed |
| DC baseline (pedestal) | 80 mV or less @ 50 Ω |
| TD peak current | (50 ± 10) mA |
| Source impedance | (50 ± 2) Ω |
| Leading edge transition time, 10%–90% | 40 ps or less |
| Pulse aberrations | ±20% or less for the first 2 ns following leading step transition. ±7% or less over the zone 2 ns to 10 ns following leading step transition. ±3% or less over the zone 10 ns to 15 ns following leading step transition. ±2% or less over the zone 15 ns to (pulse width–50 ns). |
| Trailing edge transition time, 10%–90% | 8 ns or less |
| RMS jitter, trigger output-to-output | 1.5 ps typ, 2 ps max |
| Deskew between outputs | |
| Range | Each output: 200 ps min, 300 ps typical |
| Resolution | Adjustable in a 20 ps coarse increment, 1 ps fine increment |
| Delay, trigger output-to-output | (42 ± 2) ns, fixed |
| Output connector | N, male. Pulse Heads come standard with one N(f)-SMA(m) adaptor. |

6.4 Timing

| Specifications | PicoSource PG911, PG912 and PG914 | | |
|---------------------------------|--|--|------------------------|
| Trigger source | Internal clock or external trigger | | |
| Trigger mode | Continuous, or manual single-shot event | | |
| Internal clock period | | | |
| Range | 1 μ s to 1 s | | |
| Resolution | 200 ns | | |
| Accuracy | $\pm(10 \text{ ns} + 100 \text{ ppm of period})$ | | |
| Pulse width | | | |
| Range | From 200 ns to 4 μ s | | |
| Resolution | 25 ns | | |
| Accuracy | $\pm(50 \text{ ns} + 10\% \text{ of pulse width})$ | | |
| RMS Jitter | 150 ppm of pulse width or less | | |
| Delay, trigger output-to-output | | | |
| Tunnel diode outputs | N/A | (42 \pm 2) ns, fixed. With cable included | |
| Step recovery diode outputs | (48 \pm 2) ns, fixed | N/A | (48 \pm 2) ns, fixed |

6.5 External trigger input

| Specifications | PicoSource PG911, PG912 and PG914 |
|---|---|
| Bandwidth | DC to 1 GHz |
| Sensitivity | 20 mV p-p DC to 100 MHz. Increasing linearly from 20 mV p-p at 100 MHz to 100 mV p-p at 1 GHz. |
| Minimum pulse width | 500 ps @ 100 mV p-p |
| RMS trigger jitter, external trigger input - to - trigger output | 2.5 ps typ, 3 ps max |
| Trigger slope | Selectable rising or falling edge |
| Delay, external trigger input-to-trigger output | (4 ± 1) ns |
| Trigger level range | -1 V to 1 V |
| Trigger level resolution | 1 mV |
| Rise time | TBD |
| Maximum safe trigger input voltage | 16 dBm, or ±2 V (DC + AC pk) |
| Trigger nominal input impedance | (50 ± 0.5) Ω |
| Trigger coupling | DC-coupled |
| Trigger input connector | SMA(f) |
| Trigger holdoff | |
| Range | 1 μs to 1 s |
| Resolution | 200 ns: 1 μs to 1.3 ms, 500 ns: > 1.3 ms to 5 ms, 1 μs: > 5 ms to 10 ms, 2 μs: > 10 ms to 20 ms, 5 μs: > 20 ms to 40 ms, 10 μs: > 40 ms to 85 ms, 20 μs: > 85 ms to 170 ms, 50 μs: > 170 ms to 1 s |

6.6 Trigger output

| Specifications | PicoSource PG911, PG912 and PG914 |
|------------------------|--|
| Waveform | Fixed amplitude and timing parameters, trigger is leading edge |
| Polarity | Positive |
| Amplitude | <i>700 mV or more fixed @ 50 Ω</i> |
| DC baseline | ± 100 mV or less |
| Pulse width | (500 ± 100) ns @ 50 Ω |
| Transition time | |
| 10%–90% | <i>400 ps or less @ 50 Ω</i> |
| 20%–80% | <i>300 ps or less @ 50 Ω</i> |
| Connector | SMA(f) |

6.7 General

| Specifications | PicoSource PG911, PG912 and PG914 |
|---|---|
| Operating system | Microsoft Windows® XP (SP2), Windows Vista, Windows 7, Windows 8. (Not Windows RT). 32-bit and 64-bit versions. |
| Setup | The instrument can store and recall complete setups |
| File extension | Setup files: .set |
| Save/recall setups | The instrument can store complete setups in the memory and then recall them |
| Power requirements | |
| Power supply voltage | +5 V ± 5%. Universal plug top AC to DC adaptor included |
| Power consumption | 1.6 A, 8 W max |
| PC connection | USB 2.0 (FS). (USB 1.1 and USB 3.0 compatible.) 1.8 m USB 2.0 lead included |
| Physical characteristics | |
| Dimensions | Instrument: Width: 190 mm. Height: 40 mm. Depth: 180 mm TD Pulse Heads: Width: 80 mm. Height: 28 mm. Depth: 25 mm. |
| Net Weight | Instrument: 560 g max. TD Pulse Heads: 125 g. max |
| Environmental conditions | |
| Operating temperature range | Operating: +5 °C to +35 °C |
| Storage temperature range | -20 °C to +50 °C |
| Temperature range for stated specifications | +15 °C to +25 °C or T _{CAL} (temperature of calibration) ± 5 °C |
| Operating humidity range | Up to 85 % relative humidity (non-condensing) at +35°C |
| Storage humidity range | Up to 95 % relative humidity (non-condensing) |

Index

A

- Accessories 13
- Altitude 10

C

- Calibration 10
- Characteristics 48
- Connectors 14
- Crosstalk connections 19

D

- Disk space 6
- Display 25

E

- Environment 10
- External trigger input 23, 36

F

- Features 5
- Free-running operation 20, 22

G

- Grounding 9

H

- Horizontal scaling 42
- Humidity 10

I

- Intensified zone 27

K

- Kit contents 13

L

- License conditions 11

M

- Main menu 45
- Memory 6

- Microsoft Windows 6
- Models 5

O

- Operating system 6

P

- PC requirements 6
- PicoSource PG900 software 25
- Pollution degree 10
- Power connection 9
- Processor 6

R

- Ranges, maximum 8
- Repair 10

S

- Safety
 - introduction 6
 - symbols 7
- Scaling 40
- Servicing 10
- Setting up 16
- Single trigger 24
- Specifications 48

T

- TDR connections 16
- TDT connections 18
- Temperature 10
- Timing controls 34
- Trademarks 12
- Trigger output 39
- Tunnel diode pulse heads 32

U

- Undo/Redo 44
- USB connection 9

V

- Vertical scaling 40

W

- Warranty 12

United Kingdom headquarters:

Pico Technology
James House
Colmworth Business Park
St. Neots
Cambridgeshire
PE19 8YP
United Kingdom

Tel: +44 (0) 1480 396 395
sales@picotech.com
support@picotech.com

United States headquarters:

Pico Technology
320 N Glenwood Blvd
Tyler
TX 75702
United States

Tel: +1 800 591 2796
sales@picotech.com
support@picotech.com

Asia-Pacific head office:

Pico Technology
Room 2252, 22/F, Centro
568 Hengfeng Road
Zhabei District
Shanghai 200070
PR China

Tel: +86 21 2226-5152
pico.asia-pacific@picotech.com

Germany regional office and EU authorized representative:

Pico Technology GmbH
Im Rehwinkel 6
30827 Garbsen
Germany

Tel: +49 (0) 5131 907 62 90
info.de@picotech.com

www.picotech.com

