

RESISTANCE HiTESTER 3541

Component measuring instruments

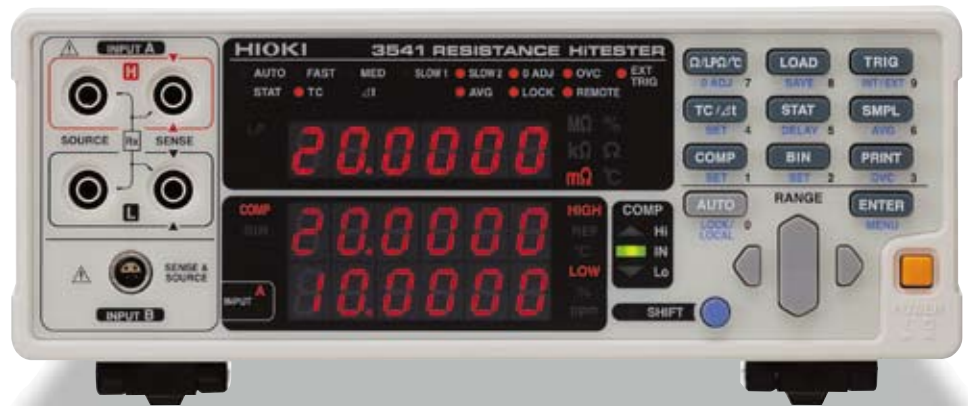

0.1 $\mu\Omega$ (20 m Ω range) to 110.000 M Ω

Measure from very low ($\mu\Omega$) to very high (M Ω) resistances with a single instrument

Along with capabilities for fast, precise measurements over a broad resistance range, Model 3541 also provides functions for temperature correction, comparator and data I/O. Employing a four-terminal measurement method, this instrument is particularly suitable for measuring the resistance of motor and transformer windings, relay/switch and connector contacts, PCB patterns, chip inductor DC resistance and in shipping inspection tests.



ISO 9001
JMI-0216



ISO 14001
JQA-E-90091



www.hioki.com

HIOKI company overview, new products, environmental considerations and other information are available on our website.

Speed & Precision at Their Highest

From the Laboratory to System Applications

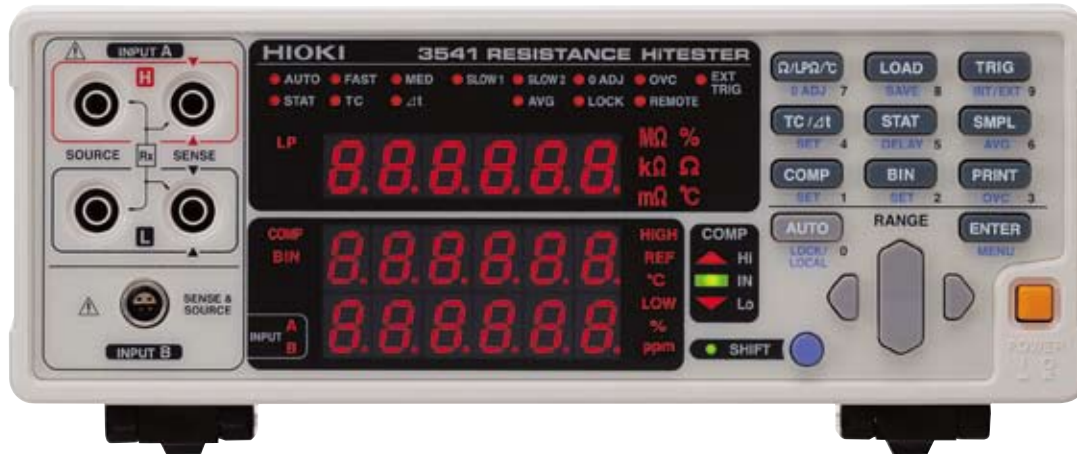

(All indicators shown lit for purposes of illustration)

Major Features

- **Wide Measurement Range**
0.1 $\mu\Omega$ (20 m Ω range) to 110.000 M Ω
- **High Speed & High Precision Measurements**
As fast as 0.6 ms with 70 ppm precision (in the 2 k Ω to 110 k Ω range)
- **Low-Power Measurement Function**
Essential for DCR measurements of chip inductors and connector contacts
- **Comparator and BIN Functions**
Fast PASS/FAIL judgments, and measurement value ranking in ten levels
- **Two Types of Temperature Correction**
Correction by Pt sensor or infrared thermometer
- **Multipolar Connector**
Low thermoelectromotive force supports high-speed measurements
- **Measurement Fault Detection**
Enhanced measurement reliability by monitoring contact using all four leads
- **Temperature Conversion Function**
Uses resistance to shows temperature variations of measurement objects
- **Offset Voltage Compensation**
Minimizes thermoelectromotive effects
- **Equipped with EXT I/O, GP-IB and RS-232C interfaces**
Easily integrates into automated production lines
- **Statistical Calculation Functions**
Use for process analysis and quality control
- **Stores up to 30 sets of measurement conditions**
Measurement conditions can be changed quickly
- **Data Printing**
Print out measurement values and calculation results (with optional Model 9670 Printer)



■ Comparator

Compares measurements with preset upper and lower limits, and displays and outputs the judged range of each measurement. Two setting methods are available: absolute value (upper/lower limit setting) and relative value (% of a reference value), and judgment results, indicated by Hi, IN or Lo LEDs and beeper, are also output via EXT I/O, RS-232C and GP-IB interfaces.

◆ Judgments

Hi: Display Value > Upper Limit, or OF
 IN: Display Value between Upper and Lower Limits
 Lo: Display Value is < Lower Limit, or -OF

◆ Relative Value Judgment

Display: $\{(\text{Measured Resistance}) - (\text{Reference Value})\} / (\text{Reference Value})$
 -99.999% to 99.999%

◆ Beeper

OFF: Beeper does not sound
 IN: Beeper sounds when the judgment result is IN
 Hi/Lo: Beeper sounds when the judgment result is high or low



- Setup by Upper (Hi) and Lower (Lo) Limits
 Upper and Lower limit range: 0 to 999,999



- Setup by Reference Value (REF) and Range (%)
 Setting range: Reference Value = 0 to 999,999
 % = 00.000 to 99.999%

■ Classify measurements in up to ten ranking BINs

According to a preset range, measurements can be classified in up to ten ranks (BIN0 through BIN9). Settings are the same as for the comparator, using either absolute or relative values with results displayed and output to EXT I/O, RS-232C and GP-IB interfaces.

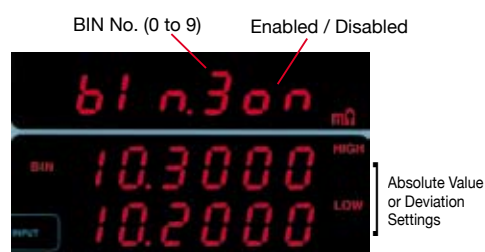

- Setting ranges are the same as for the comparator function.

■ Store up to 30 sets of measurement conditions

Including settings for comparator and BIN measurements, up to 30 sets of measurement conditions can be stored and recalled by just selecting a setting number, so setting conditions can be changed quickly. Settings can also be accessed by remote control.

Excellent Stability

Actual measurement results showing minimum dispersion

(OVC = Offset Voltage Compensation)

[20 mΩ Range/SLOW2]

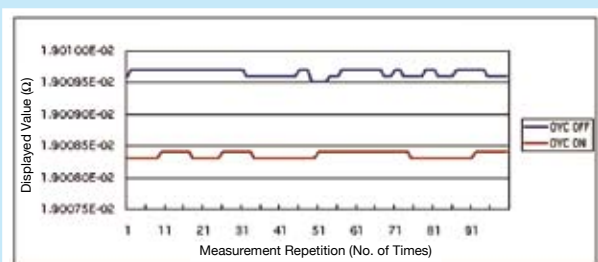

[20 mΩ Range/MEDIUM]

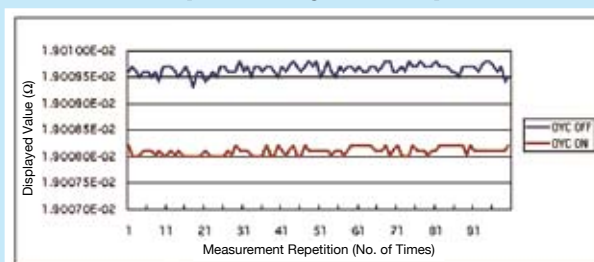

[200 Ω Range/FAST & MEDIUM]

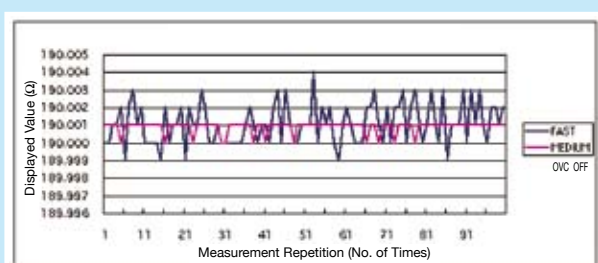

[Low-Power Ohms: 2 W Range/FAST & MEDIUM]

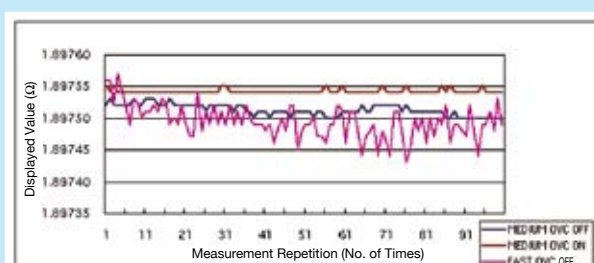

Two types of temperature correction

Temperature correction functions regardless of materials and temperature

Using the 9451 Temperature Probe, resistance values measured at ambient temperature can be corrected by applying a thermal coefficient so that the display shows the corresponding resistance values at any other temperature.

Settings

For example, the resistance of a copper wire that measures 100Ω at 30°C ambient can be corrected for display as the resistance it would have at 23°C by applying the thermal coefficient (3930 ppm for copper when the conductivity ratio is 1), using the following settings.



Reference Temperature
Setting Range: -10 to 99.9°C
Thermal Coefficient: -9999 to 9999 ppm



For proper correction, the measurement object must be at ambient temperature.

Temperature Probe 9451 (supplied accessory)

Temperature Correction by Analog Output (Infrared Thermometer)

Make temperature corrections by measuring the surface temperature of the measurement object using the analog output from an infrared thermometer, or through the RS-232C interface. Even when the measured object is not at ambient temperature, temperature correction can be applied. Actual temperature can be measured as well.

(When connecting the thermometer to the RS-232C interface, the GP-IB function is not available.)

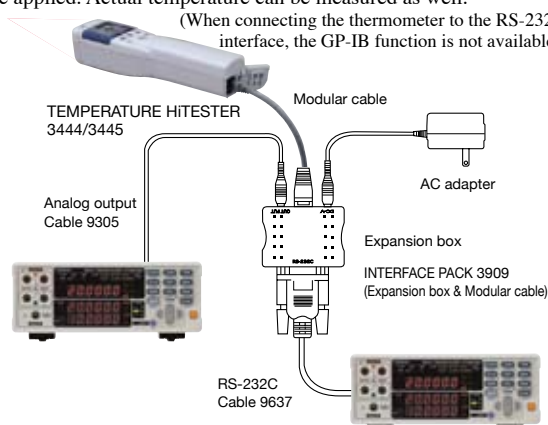

Convenient Temperature Conversion Function for Motor Coil Verification

Temperature increase (Δt) is obtained and displayed by converting resistance measurements and ambient temperature. This function is especially useful for verifying motor windings or coils, where the maximum temperature increase needs to be determined when current is applied.

*The temperature conversion function cannot be used simultaneously with the temperature correction function.

- ① When a motor or coil has thermally stabilized at room temperature, measure the resistance (r_0) and ambient temperature (t_0) before applying current.
- ② Excite the coil, and when the temperature increase appears to saturate, remove the excitation.
- ③ After removing excitation, determine the temperature (Δt_1 to Δt_n) from the resistance (r) measured at each specific time (t), and the ambient temperature.
- ④ Project the curve through the collected temperature data (Δt_1 to Δt_n) to estimate the maximum temperature increase (Δt).

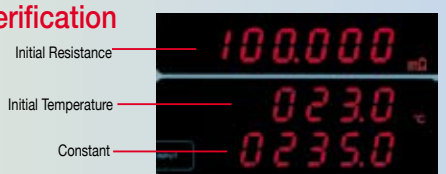

[Temperature Conversion Setting Mode]

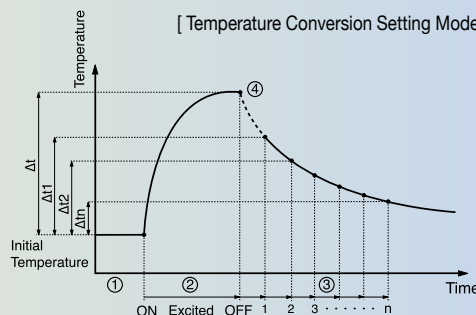

For measurements unaffected by test leads or contact resistance

Four-Terminal Resistance Measurements

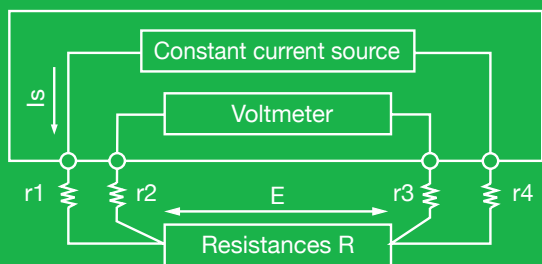

(Values r_1 through r_4 are the combined resistances of the test leads and contact resistances.)

With two-terminal measurements, the conductor resistance of the test leads and the contact resistance of the connections are included in the measured resistance, resulting in measurement errors. The four-terminal measurement method employs a very high input impedance voltmeter, whereby almost all measurement current is conducted through measured resistance R . By measuring the voltage drop across only R , its resistance is measured without being significantly affected by r_1 to r_4 .

$$R = \frac{E}{I_s}$$



Multi-functional support for various applications

■ Measurement Fault Detection

Integrity of source and sensor leads and the constant-current supply are continually monitored to ensure measurements with high confidence. When a measurement fault is detected it is indicated on the instrument, and ERR is output from the EXT I/O interface.

■ Offset Voltage Compensation

Thermoelectromotive force occurs at the contact point of different metals. This force affects measurements, and if large enough, it can result in measurement errors. The offset voltage compensation function minimizes the effect of thermoelectromotive force to preserve measurement accuracy.

■ Self-Calibration

Consistent accuracy is maintained by automatic correction of internal circuit offset voltage and gain drift. Self-calibration is applied at every measurement using SLOW1/SLOW2 sampling, and every 30 minutes with FAST/MEDIUM sampling. Self-calibration is also performed at power on, and when measurement conditions are changed.

(Self calibration is enabled when AUTO is selected)

■ Statistical Calculation Functions

To observe process conditions, the mean (\bar{x}), maximum (Max), minimum (Min) overall standard deviation (s), standard deviation of sample (s) and process productivity index (Cp: dispersion, CpK: bias) can be calculated using up to the maximum of 30,000 measurement values.

■ Data Printing

Measurement values, and those including judgment results and statistical calculation results can be printed using the optional Printer 9670.

● Interval Printing

Print out the elapsed time and measurement results in 1- to 3600-second intervals.

Print method : Thermal line dot
 Print width : 72 mm
 Print speed : 47.5 mm/s
 Power : AC Adapter 9671 or Battery Pack 9672
 Dimensions : Approx. 119 × 77 × 174 mm
 Mass : Approx. 500 g

Printer operation requires RS-232C Cable 9638 and AC Adapter 9671, and battery operation requires Battery Pack 9672 and Battery Charger 9673.

■ Multipolar Connector

A sealed shielded, low-thermoelectromotive-force multipolar connector (INPUT B) is provided. The excellent noise immunity of this input makes it ideal for high-speed measurements of large resistances, as well as low power measurements.



■ Low Power Measurement

Measures with 10 $\mu\Omega$ resolution (2 Ω range) using just 10 mA measurement current. This is ideal for measuring chip inductor DCR and connector contact resistance.

(Low power measurement is available in the 2 Ω to 2k Ω ranges)

■ Average

Measurement values can be averaged to minimize display instability. With Free Run selected, the display shows the moving average; otherwise, the display shows the average value over a period. The number of samples to average can be set from 2 to 100.

Number	12
Valid	11
Average	1209.25 Ohm
Max	1300.15 Ohm(12)
Min	1200.10 Ohm(9)
Sn	28.744 Ohm
Sn-1	30.147 Ohm
Cp	0.00
CpK	0.00
1200.06 Ohm to 1200.08 Ohm	0
1200.08 Ohm to 1200.10 Ohm	0
1200.10 Ohm to 1200.12 Ohm	0
1200.12 Ohm to 1200.14 Ohm	1
1200.14 Ohm to 1200.16 Ohm	1
1200.16 Ohm to 1200.18 Ohm	2
1200.18 Ohm to 1200.20 Ohm	5
1200.20 Ohm to 1200.22 Ohm	2
1200.22 Ohm to 1200.24 Ohm	0
1200.24 Ohm to 1200.26 Ohm	0
Out of BIN	1
Invalid	1

[Print Example]

38.418kOhm
 38.55kOhm
 0.0403 Ohm
 0.08 Ohm
 0.498kOhm
 19.9950kOhm
 10.0117MOhm

[Measurement Values]

109.556MOhm Hi
 109.542MOhm IN
 109.548MOhm Lo
 0.F. Hi
 - 0.F. Lo

[Measurement Values including Judgment Results] COMP-ON

[Statistical Calculation Results] BIN-ON

Number	11
Valid	10
Average	1200.16 Ohm
Max	1200.20 Ohm(9)
Min	1200.13 Ohm(1)
Sn	24.104mOhm
Sn-1	25.406mOhm
Cp	0.19
CpK	0.03
Comp Hi	4
Comp IN	6
Comp Lo	0

[Statistical Calculation Results] COMP-ON

Ideal for high-speed automated production lines

External control by EXT I/O

Starting measurement and loading measurement conditions can be externally controlled, and judgment results, BIN and BCD data can be output, providing easy incorporation in automated lines. General-purpose output is implemented by control of output signals using : IO : OUT commands.

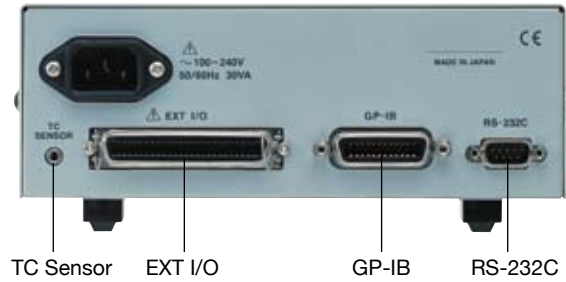

When connecting an infrared thermometer to the RS-232C interface, the GP-IB function is not available.

External Trigger Timing Chart

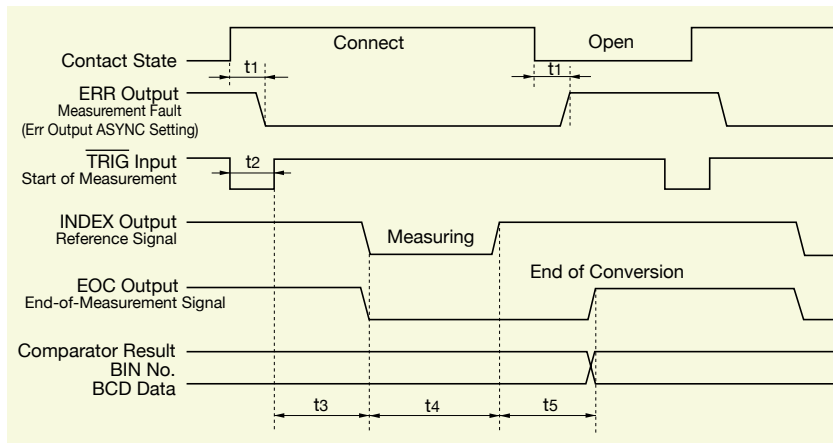

- t1: ERR Output Response Time: 100 μ s
 t2: Measurement Trigger Pulse Width: 100 μ s (min.)
 t3: Delay Time: per setting
 t4: Input Time: depends on sampling rate, Offset Voltage Compensation on/off, average, delay and supply frequency
 (Fastest: 300 μ s: with FAST sampling and Offset Voltage Compensation Off)
 t5: Calculation Time: depends on calculation settings such as sampling rate and comparator
 (Fastest: 300 μ s: with FAST sampling)

EXT I/O Signals

● Input Signals

- LOAD (0 - 4) : Selection number to load
 TRIG : External trigger
 PRINT : Print on printer
 0ADJ : Zero adjustment
 CAL : Self calibration

● Output Signals

- ERR : Measurement fault detected
 EOC : End of conversion
 INDEX : End of input
 Hi : Comparator Hi
 IN : Comparator IN
 Lo : Comparator Lo
 BIN0 to BIN9, OB : BIN outputs*1
 BCD1-0 to BCD6-3 : BCD outputs*1
 OUT0 to OUT7 : General purpose outputs*2
 VCC : Internal power
 GND : Internal GND

*1 BIN and BCD outputs are not available at the same time.

*2 General purpose outputs (OUT0 - OUT7) are disabled when BCD output is selected.

External Control by Personal Computer

RS-232C and GP-IB interfaces are included as standard features. All functions other than the power switch can be controlled via these terminals.

(Except when connecting an infrared thermometer to the RS-232C interface.)

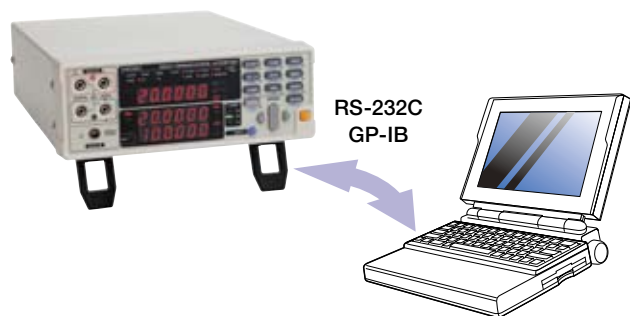

GP-IB

- SH1 : Supports all Source Handshake functions
 AH1 : Supports all Acceptor Handshake functions
 T6 : Supports Standard Talker functions
 Supports Serial Poll functions
 Talk-Only mode is not supported
 Supports Talker Cancel function by MLA (My Listen Address)
 L4 : Supports Standard Listener
 Listen-Only mode not supported
 Supports Listener Cancel function by MTA (My Talk Address)
 SR1 : Supports all Service Request functions
 RL1 : Supports all Remote/Local functions
 PP0 : Parallel Poll function not supported
 DC1 : Supports all Device Clear functions
 DT1 : Supports all Device Trigger functions
 C0 : Controller function not supported

RS-232C

- Transmission method : Start/stop synchronization type, full duplex
 Transmission speed : 9600 bps
 Data length : 8 bits
 Stop bits : 1 bit
 Parity : none
 Delimiters : CR+LF for Tx, CR or CR+LF for Rx
 Flow control : none
 Connector : Male 9-pin D-sub, with #4-40 attachment screws

■ Accuracy

(1) Resistance Measurement [1-Year Accuracy (at 23±5°C) Accuracy: ±(ppm of rdg. + ppm of f.s.)]

Offset voltage compensation : OFF (upper) ON (lower) (20 mΩ to 20 kΩ ranges) 1 ppm=1/1,000,000 (100 ppm=0.01%)

Range *1	Maximum display value	Resolution	SLOW2	SLOW1	MEDIUM	FAST	Measurement Current	Open-Terminal Voltage
20 mΩ	20.0000 mΩ	0.1 μΩ	1000 + 150	1000 + 170	1000 + 200	1000 + 250	1 A ± 5%	5 Vmax
			1000 + 10	1000 + 10	1000 + 10	1000 + 40		
200 mΩ (1A)	200.000 mΩ	1 μΩ	1000 + 60	1000 + 80	1000 + 120	1000 + 170	1 A ± 5%	5 Vmax
			1000 + 10	1000 + 10	1000 + 10	1000 + 20		
200 mΩ *2 (100mA)	200.000 mΩ	1 μΩ	1000 + 100	1000 + 120	1000 + 150	1000 + 200	100 mA ± 5%	2.6 Vmax
			1000 + 10	1000 + 10	1000 + 20	1000 + 80		
2 Ω	2000.00 mΩ	10 μΩ	140 + 40	140 + 60	140 + 100	140 + 150	100 mA ± 5%	2.6 Vmax
			140 + 10	140 + 10	140 + 10	140 + 40		
20 Ω	20.0000 Ω	100 μΩ	100 + 40	100 + 60	100 + 100	100 + 150	10 mA ± 5%	2.6 Vmax
			100 + 10	100 + 10	100 + 10	100 + 40		
200 Ω	200.000 Ω	1 mΩ	80 + 15	80 + 30	80 + 40	80 + 100	10 mA ± 5%	2.6 Vmax
			80 + 10	80 + 10	80 + 10	80 + 40		
2 kΩ	2000.00 Ω	10 mΩ	70 + 15	70 + 30	70 + 40	70 + 100	1 mA ± 5%	2.6 Vmax
			70 + 10	70 + 10	70 + 10	70 + 100		
20 kΩ	20.0000 kΩ	100 mΩ	70 + 15	70 + 30	70 + 40	70 + 100	100 μA ± 5%	2.6 Vmax
			70 + 10	70 + 10	70 + 10	70 + 100		
100 kΩ	110.000 kΩ	1 Ω	70 + 30	70 + 60	70 + 80	70 + 200	100 μA ± 5%	13 Vmax
1 MΩ	1100.00 kΩ	10 Ω	80 + 30	80 + 60	80 + 80	150 + 100	10 μA ± 5%	13 Vmax
10 MΩ	11.0000 MΩ	100 Ω	400 + 60	400 + 90	400 + 140	3000 + 200	1 μA ± 5%	13 Vmax
100 MΩ	110.000 MΩ	1 kΩ	2000 + 200	2000 + 230	2000 + 250	30000 (3%)+300	100 nA ± 5%	13 Vmax

Note *1: 100 kΩ range and above are calculated as f.s. = 100,000 dgt.

Note *2: The 200mΩ range with 100 mA measurement current can be selected during power-up or by remote command.

(2) Low-Power Resistance Measurements [1-Year Accuracy(at 23±5°C) Accuracy: ±(ppm of rdg. + ppm of f.s.)]

Offset voltage compensation : OFF (upper) ON (lower)

Range	Maximum display value	Resolution	SLOW2	SLOW1	MEDIUM	FAST	Measurement Current	Open-Terminal Voltage
2 Ω	2000.00 mΩ	10 μΩ	110 + 100	110 + 120	110 + 150	110 + 200	10 mA ± 5%	60 mVmax
			110 + 10	110 + 10	110 + 20	110 + 80		
20 Ω	20.0000 Ω	100 μΩ	110 + 100	110 + 120	110 + 150	110 + 200	1 mA ± 5%	60 mVmax
			110 + 10	110 + 10	110 + 20	110 + 80		
200 Ω	200.000 Ω	1 mΩ	110 + 100	110 + 120	110 + 150	110 + 200	100 μA ± 5%	60 mVmax
			110 + 10	110 + 10	110 + 20	110 + 80		
2 kΩ	2000.00 Ω	10 mΩ	110 + 100	110 + 120	110 + 150	200 + 200	10 μA ± 5%	60 mVmax
			110 + 10	110 + 10	110 + 20	200 + 80		

Note: Open-terminal voltage is limited to 20 mV or less from the time an external trigger causes INDEX = Hi until the next trigger input.

■ Resistance Measurement

- No temperature correction after zero adjustment.
- Within 0 to 18 and 28 to 40°C, add ±(1/10 Measurement Accuracy)/°C to the above measurement accuracy.
- 60 minutes warm-up (After 30 minutes warm-up, accuracy is twice the specified range).
- Self calibration occurs after warm-up in FAST and MEDIUM modes Temperature variation after warm-up is within ±2°C.
- For the 20mΩ and 200mΩ ranges, the condition [resistance of cable + contact resistance] ≤ 300 mΩ must be satisfied.

- During temperature correction, the value calculated below is added to the rdg error for resistance measurement accuracy:

$$\frac{-100 \alpha_{t_0} \Delta t}{1 + \alpha_{t_0} \times (t + \Delta t - t_0)} \quad [\%]$$

t_0 : Reference temp. [°C]
 t : Ambient temp. [°C]
 Δt : Temp. measurement accuracy
 α_{t_0} : Temp. coefficient at t_0 is [1/°C]

* Open-terminal voltage specifications may be momentarily exceeded when probe is removed from the sample.

■ Temperature Measurement

(1) Pt sensor (9451-Pt500, at 25°C)

Range of Guaranteed Accuracy	-10.0°C to 39.9°C	40.0°C to 99.9°C
Resolution	0.1°C	
6-Month Accuracy	±0.30% rdg. ±0.5°C*	±0.30% rdg ±1.0°C*
1-Year Accuracy	±0.45% rdg. ±0.8°C*	±0.45% rdg ±1.5°C*

*Accuracy is in combination with Temperature Probe 9451.
 Accuracy of instrument alone is ±0.2°C/6 Months (±0.3°C/year).
 Add temperature coefficient ±0.02°C/°C to above accuracy for ambient temperature ranges 0 to 18 and 28 to 40°C.

(2) Analog Input (1-Year Accuracy)

Input Range	0 V to 2 V
Display	-99.9 to 999.9°C
Resolution	1 mV or better
Resolution	±1% rdg. ±3 mV*

* Conversion method temperature accuracy (Only 3541).

$$1\% \times (T_R - T_{OV}) + 0.3\% \times (T_{1V} - T_{OV})$$

T_{1V} : Temperature at 1V input, T_{OV} : Temperature at 0V input, T_R : Current temp.

Add temperature coefficient (±0.1% rdg. ±0.3 mV)/°C to above accuracy for ambient temperature ranges 0 to 18 and 28 to 40°C.

■ Specifications

Measurement : Four-terminal resistance measurement
 0.1 $\mu\Omega$ (20 m Ω range) to 110.000 M Ω
 Low power four-terminal resistance measurement
 10 $\mu\Omega$ (2 Ω range) to 2.00000 k Ω
 Temperature measurement (Pt) -10.0 to 99.9°C
 Temperature measurement (analog) 0 to 2V

Range switching : Auto or Manual

Zero adjust : Zero-adjust range is 1,000 dgt for each measurement range

Trigger : Internal or External

Sampling : SLOW2, SLOW1, MEDIUM and FAST

Analog response time : 1 ms (in 200 Ω range)
 (depends on range and conditions)

Functions : Temperature correction, temperature conversion, self calibration, measurement fault detection, overflow detection, offset voltage compensation, average, statistical calculation, key lock, save/load, comparator, BIN measurement

■ General Specifications

Operating temperature and humidity : 0 to 40°C, 80% RH or less (non-condensating)

Storage temperature and humidity : -10 to 40°C, 80% RH or less (non-condensating)

Guaranteed accuracy : 23 \pm 5°C, 80% RH or less (non-condensating) temperature and humidity

Operating environment : Indoors, 2000 m ASL or below

Rated supply voltage : 100 to 240 VAC \pm 10%

Rated supply frequency : 50/60 Hz

Rated power consumption : 30 VA

Insulation withstand potential : 1.39 kVAC for 15s, with 10 mA cutoff current
 [All power supply terminals] - [Protective ground]

Dimensions : Approx. 215W \times 80H \times 295D mm (excluding projections)

Mass : Approx. 2.6 kg

● Sampling (Resistance and Low Power Resistance measurements)

Measurement time (from trigger until EOC=ON) [ms]
 (t₄+t₅ in Timing Chart on page 5)

Supply Frequency	SLOW2	SLOW1	MEDIUM	FAST
50Hz	455 \pm 10	155 \pm 5	21 \pm 1	0.6 \pm 0.3
60Hz	449 \pm 10	149 \pm 5	17 \pm 1	

Delay = 0 ms, TC OFF, Statistical calculation OFF, Offset Voltage Correction OFF

Acquisition time (from INDEX = OFF to INDEX = ON) [ms]
 (t₄ in Timing Chart on page 5)

Supply Frequency	SLOW2	SLOW1	MEDIUM	FAST
50Hz	400 \pm 10	100 \pm 5	20.0 \pm 1	0.30 \pm 0.1
60Hz			16.7 \pm 1	

● Temperature Measurement: Measurement Cycle; 400 \pm 10 ms

● Delay [ms] (AUTO) [OVC: Offset Voltage Compensation]

• Resistance Measurement

Range [Ω]	20m	200m	2 to 20k	100k	1M	10M	100M
OVC OFF	30		3	10	100	500	1000
OVC ON	100			-	-	-	-

• Low Power Mode

Range [Ω]	2	20	200	2k
OVC OFF	3			15
OVC ON	100			

● MANUAL:

Delay setting:
 0.000 to 9.999 s

Accessories : CLIP TYPE LEAD 9287-10, TEMPERATURE PROBE 9451, Power Cord, EXT I/O Male Connector

Applicable Standards : Safety
 EN61010-1
 Power supply Overvoltage Category II 300 V (Anticipated overvoltage 2.5 kV)
 EMC
 EN61326
 EN61000-3-2
 EN61000-3-3
 Effect of radiated radio frequency electromagnetic fields: 1% f.s.
 Effect of conducted radio frequency electromagnetic fields: 0.5% f.s.

3541 RESISTANCE HITESTER

● Options

- 9452 CLIP TYPE LEAD
- 9453 FOUR TERMINAL LEAD
- 9454 ZERO ADJUSTMENT BOARD
- 9455 PIN TYPE LEAD(for ultra precision)
- 9461 PIN TYPE LEAD
- 9465 PIN TYPE LEAD
- 9467 LARGE CLIP TYPE LEAD
- 9770 PIN TYPE LEAD
- 9771 PIN TYPE LEAD
- 9300 CONNECTION CABLE(for multipolar connectors)
- 9637 RS-232C CABLE(9pin-9pin/cross/1.8m)
- 9638 RS-232C CABLE(9pin-25pin/cross/1.8m)
- 9151-02 GP-IB CONNECTOR CABLE(2m)
- 9151-04 GP-IB CONNECTOR CABLE(4m)
- 9670 PRINTER
- 9671 AC ADAPTER(for 9670)
- 9672 BATTERY PACK(for 9670)
- 9673 BATTERY CHARGER(for 9672)
- 9237 RECORDING PAPER (80 mm \times 25 mm, 4 rolls)

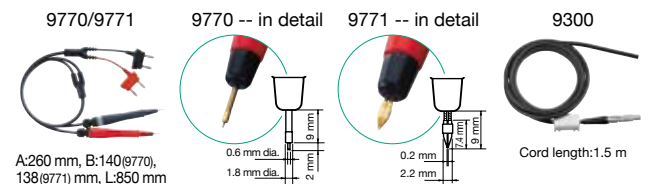
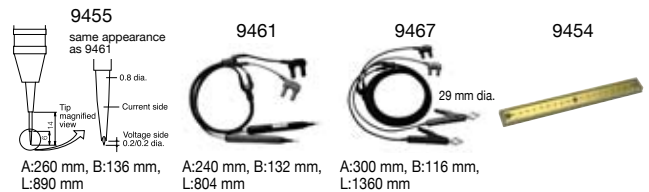
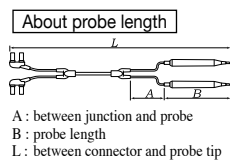

HIOKI E. E. CORPORATION

HEAD OFFICE :

81 Koizumi, Ueda, Nagano, 386-1192, Japan
 TEL +81-268-28-0562 / FAX +81-268-28-0568
 E-mail: os-com@hioki.co.jp

HIOKI USA CORPORATION :

6 Corporate Drive, Cranbury, NJ 08512 USA
 TEL +1-609-409-9109 / FAX +1-609-409-9108
 E-mail: hioki@hiokiusa.com

HIOKI (Shanghai) Sales & Trading Co., Ltd. :
 1904 Shanghai Times Square Office, 93 Huai Hai Zhong Road
 Shanghai, P.R.China POSTCODE: 200021
 TEL +86-21-6391-0090/0092 FAX +86-21-6391-0360
 E-mail: info-sh@hioki.cn

Beijing Office :
 A-2602 Freetown, 58 Dong San Huan Nan Road
 Beijing, P.R.China POSTCODE: 100022
 TEL +86-10-5867-4080/4081 FAX +86-21-6391-0360
 E-mail: info-bj@hioki.cn

Guangzhou Office :
 Room 303, Profit Plaza, No.76, West Huangpu Road
 Guangzhou, P.R.China POSTCODE: 510623
 TEL +86-20-38392673/2676 FAX +86-20-38392679
 E-mail: info-gz@hioki.cn

DISTRIBUTED BY